

2022



KYB

SHOCK ABSORBERS,
MOUNTING KITS &
PROTECTION KITS



Original
Equipment
Manufacturer



| | Model | Modell | Modèle | Modello | Model |
|--|--------------------------|----------------------------|---|--------------------------------------|---------------------------------|
| | All Models | Alle Modelle | Tous | Tutti | Bütün |
| | 2 & 4 Door Saloon | Limousine 2 & 4-türig | Berline 2 & 4 Portes | Berlina 2 - 4 Porte | 4 Kapi Sedan |
| | 3 & 5 Door Hatchback | Schrägheck 3 & 5-türig | Berline, Hatchback 3 & 5 Portes | Berlina 3 - 5 Porte | 3 & 5 Kapi Sedan Hatchback |
| | 3 Door Liftback, Hardtop | Fließheck 3 & 5-türig | Liftback, Hatchback 3 & 5 Portes | Coupé 3 - 5 Porte | 3 & 5 Kapi Liftback, Hatchback |
| | Coupé | Coupé 3-türig | Coupé, Liftback 3 Portes | Coupé 3 Porte | Coupe, 3 Kapi Liftback, Hardtop |
| | Cabriolet, Convertible | Cabriolet | Cabriolet, Décapotable | Cabriolet, Convertibile | Cabriolet, Conv. |
| | Estate | Kombi | Break, Estate | Familiare | S.Wagon |
| | Car Derived Van | Kastenwagen | Fourgonette | Van, Furgonato | Van tipi |
| | Off Road SUV | Off Road Geländewagen | Tout Terrain | Fuoristrada | Off Road |
| | Pick Up | Pick Up | Pick Up | Pick Up | Pick Up |
| | Delivery Van | Lieferwagen | Fourgon | Furgone | Panel |
| | Light Truck | Leicht-LKW | Utilitaire Léger | Autocarro Leggero | Kamyonet |
| | Chassis Cabin | Fahrerhaus mit Fahrgestell | Utilitaire Châssis Cabine | Autotelaio | Kabinli |
| | Dump Truck | Kipplader | Camion Benne | Autocarro Pesante | Damperli kamyon |
| | Mini Bus | Kleinbus | Minibus | Mini Bus | Minibüs |
| | Ambulance | Krankenwagen | Ambulance | Ambulanza | Ambulans |
| | 2-3-4-5 Doors | 2-3-4-5 Türen | 2-3-4-5 Portes | 2-3-4-5 Porte | 2-3-4-5 Kapili |
| | Standard Cabin | Standard Führerhaus | Cabine Standard | Cabina Singola | Standart Kabinli |
| | Extra Cabin | Extra Führerhaus | Cabine Allongée | Cabina Estesa | İlave Kabinli |
| | Double Cabin | Doppeltes Führerhaus | Double Cabine | Cabina Doppia | Çift Kabinli |
| | Right/Left Hand Drive | Rechtslenker/Linkslenker | Conduite à droite/ conduite à gauche | Guida a Destra / Guida a Sinistra | Sağ / Sol Dİreksiyon |
| | Engine | Motor | Moteur | Motore | Motor |
| | Petrol | Benzin | Essence | Benzina | Benzin |
| | Two Wheel Drive | Zweiradantrieb | 2 Roues Motrices | Due ruote motrici | 2 çeker |
| | Four Wheel Drive | Vierradantrieb | 4 Roues Motrices | Quattro ruote motrici | 4 çeker |
| | Front Wheel Drive | Voderradantrieb | Véhicule à traction | Trazione Anteriore | Önden çekİslİ |
| | Rear Wheel Drive | Hinterradantrieb | Véhicule à propulsion | Trazione Posteriore | Arkadan çekİslİ |
| | Four Wheel Steering | Vierradlenker | 4 Roues Directrices | Quattro Ruote Sterzanti | Mekanik direksiyon |
| | Automatic Transmission | Automatikgetriebe | Boîte Automatique | Cambio Automatico | Otomatik şanziman |
| | Manual Transmission | Schaltgetriebe | Boîte Manuelle | Cambio Manuale | Vitesli şanziman |
| | Load Capacity | Zuladung | Charge Utile | Portata Massima | Yükleme Kapasitesi |
| | Power Steering | Servolenkung | Direction Assistée | Servosterzo | Hidrolik Direksiyon |
| | Air Conditioner | Klimaanlage | Air Conditionné | Aria Condizionata | Klima |
| | Xenon Light | Xenon Licht | Phares au Xénon | Fari allo Xenon | Xenon Far |
| | Specification | Ausführung | Specification | Specifiche | Avrupa |
| | European Spec. | Europäische Ausführung | Spéc. Européenne | Mercato Europeo | Avrupa İmalati |
| | East European Spec. | Osteuropäische Ausführung | Spécifique Europe de l'est | Mercato Est Europeo | Dogu Avrupa Ülkelerine Özel |
| | Italian Spec. | Italienische Ausführung | Spécifique Italie | Mercato Italiano | İtalya'ya Özel |
| | Swedish Spec. | Schwedische Ausführung | Spécifique Suède | Mercato Svedese | İsveç'e Özel |
| | Irish Spec. | Irische Ausführung | Spécifique Irlande | Mercato Irlandese | İrlanda'ya Özel |
| | Swiss Spec. | Schweizer Ausführung | Spécifique Suisse | Mercato Svizzero | İsviçre'ye Özel |



| Specification | | Ausführung | | Specification | | Specifiche | | Model | |
|---------------|-------------------------------|---------------------------------------|---|------------------------------------|----------------------------------|-------------|--|-------------|--|
| | Israeli Spec. | Israelische Ausführung | Spécifique Israel | Mercato Israeliano | Israele Özel | | | | |
| | Turkish Spec. | Türkische Ausführung | Spécifique Turquie | Mercato Turco | Türkiye Özel | | | | |
| | Russian Spec. | Russische Ausführung | Spécifique Russie | Mercato Russo | Rusya Özel | | | | |
| | Japanese Spec. | Japanische Ausführung | Spécifique Japon | Mercato Giapponese | Japonya Özel | | | | |
| | Hot Countries' Spec. | Ausführung für heiße Länder | Spécifique Pays Chauds | Per climi caldi | Sıcak İklimli Ülkelere Özel | | | | |
| | Normal Countries' Spec. | Ausführung für normale Länder | Spécifique Pays Tempérés | Per climi temperati | Normal İklimli Ülkelere Özel | | | | |
| | Cold Countries' Spec. | Ausführung für kalte Länder | Spécifique Pays Froids | Per climi freddi | Soguk İklimli Ülkelere Özel | | | | |
| | Cars Built in UK | In GB gebaute Fahrzeuge | Véhicules fabriqués en Angleterre | Veicolo prodotto in Gran Bretagna | İngilterede İmal Edilmiş Otolar | | | | |
| | Cars Built in Spain | In Spanien gebaute Fahrzeuge | Véhicules fabriqués en Espagne | Veicolo prodotto in Spagna | İspanyada İmal Edilmiş Otolar | | | | |
| | Cars Built in Japan | In Japan gebaute Fahrzeuge | Véhicules fabriqués au Japon | Veicolo prodotto in Giappone | Japonyada İmal Edilmiş Otolar | | | | |
| | Cars Built in Hungary | In Ungarn gebaute Fahrzeuge | Véhicules fabriqués en Hongrie | Veicolo prodotto in Ungheria | Macaristanda İmal Edilmiş Otolar | | | | |
| | Cars Built in USA | In den USA gebaute Fahrzeuge | Véhicules fabriqués aux USA | Veicolo prodotto negli Stati Uniti | A.B.D de İmal Edilmiş Otolar | | | | |
| | Cars Built in Turkey | In der Türkei gebaute Fahrzeuge | Véhicules fabriqués en Turquie | Veicolo prodotto in Turchia | Turkey İmal Edilmiş Otolar | | | | |
| | Cars Built in Korea | In Südkorea gebaute Fahrzeuge | Véhicules fabriqués en Corée | Veicolo prodotto in Corea | Kore Üretimi Otolar | | | | |
| | Cars Built in Slovakia | In der Slowakei gebaute Fahrzeuge | Véhicules fabriqués en Slovaquie | Veicolo prodotto in Slovacchia | Slovakya Üretimi Otolar | | | | |
| | Cars Built in Czech Republic | In Tschechien gebaute Fahrzeuge | Véhicules fabriqués en République Tchèque | Veicolo prodotto in Rep. Ceca | Çek Cumhuriyeti Üretimi Otolar | | | | |
| | Cars Built in France | In Frankreich gebaute Fahrzeuge | Véhicules fabriqués en France | Veicolo prodotto in Francia | Fransa Üretimi Otolar | | | | |
| | Cars Built in Brazil | In Brasilien gebaute Fahrzeuge | Véhicules fabriqués au Brésil | Veicolo prodotto in Brasile | Brezilya Üretimi Otolar | | | | |
| | Cars Built in China | In China gebaute Fahrzeuge | Véhicules fabriqués en Chine | Veicolo prodotto in Cina | Çin Üretimi Otolar | | | | |
| | Cars Built in Germany | In Deutschland gebaute Fahrzeuge | Véhicules fabriqués en Allemagne | Veicolo prodotto in Germania | Almanya Üretimi Otolar | | | | |
| | Cars Built in the Netherlands | In den Niederlanden gebaute Fahrzeuge | Véhicules fabriqués aux Pays-Bas | Veicolo prodotto in Olanda | Tayland Üretimi Otolar | | | | |
| | Cars Built in Russia | In Russland gebaute Fahrzeuge | Véhicules fabriqués en Russie | Veicolo prodotto in Russia | Rusya Üretimi Otolar | | | | |
| | Cars Built in Thailand | In Thailand gebaute Fahrzeuge | Véhicules fabriqués en Thaïlande | Veicolo prodotto in Thailandia | Tayland Üretimi Otolar | | | | |
| Suspension | | Aufhängung | | Suspension | | Sospensione | | Süspansiyon | |
| | Heavy Duty Suspension | Verstärkte Ausführung | Suspension Renforcée | Sospensioni Uso Gravoso | Kötu yollara uygun direksiyon | | | | |
| | Front | Vorn | Avant | Anteriore | Ön | | | | |
| | Rear | Hinten | Arrière | Posteriore | Arka | | | | |
| | Wheel Base Distance | Radstand | Empattement | Interasse | Dingil Mesafesi Göre Ayarlı | | | | |
| | Short Body, Short Wheel Base | Kurzes Chassis, kurzer Radstand | Châssis court | Passo Corto | Kisa | | | | |
| | Long Body, Long Wheel Base | Langes Chassis, langer Radstand | Châssis long | Passo Lungo | Soguk İklimli Ülkelere Özel | | | | |
| | Rigid Axle | Starre Achse | Essieu rigide | Assale Rigido | Sabit akslı | | | | |
| | Independent Axle | Einzelradaufhängung | Roue indépendante | Ruote Indipendenti | Hareketli akslı | | | | |
| | Stabiliser | Stabilisator | Barre stabilisatrice | Barra stabilizzatrice | Stabilizatör | | | | |
| | Torsion Bars | Torsionsstäbe | Barre de torsion | Barra di torsione | Hareketli mil | | | | |
| | Coil Spring Suspension | Schraubenfederung | Suspension avec ressorts hélicoïdaux | Sospensione con Molla Elicoidale | Helezon yaylı | | | | |
| | Leaf Spring Suspension | Blattfederung | Suspension à lames de ressort | Sospensione con Balestra | Makaslı | | | | |
| | Air Spring Suspension | Luftfederung | Suspension Pneumatique | Sospensione con Molla ad Aria | Soguk İklimli Ülkelere Özel | | | | |
| | Single Tyre | Einfachbereifung | Pneu simple | Ruota singola | Tek jantlı | | | | |
| | Double Tyre | Doppelbereifung | Pneus jumelés | Ruota Gemellata | Çift jantlı | | | | |



| | Suspension | Aufhängung | Suspension | Sospensione | Süspansiyon |
|---|---|--|---|---|---|
| | 12 - 18" Tyre | 12" - 18" Räder | Pneu 12" - 18" | Pneumatico 12" - 18" | 12" - 18" jant |
| | Adjustable Shock Absorber | Einstellbare Stoßdämpfer | Amortisseur réglable | Ammortizzatore regolabile | Ayarlanabilir amortisör |
| | Original Raised Vehicle | Ab Werk höhergelegtes Fahrzeug | Véhicule surélevé d'origine | Assetto Rialzato di Fabbrica | Orjinal kalkık araba |
| | Original Lowered Vehicle | Ab Werk tiefergelegtes Fahrzeug | Véhicule surbaissé d'origine | Assetto Ribassato di Fabbrica | Orjinal düşük araba |
| | Height Control | Niveauregulierung | Contrôle de la hauteur | Altezza Variabile | Terazi ayarlı |
| | For bad road suspension | Schlechtwegefahrwerk | Suspension pour mauvaises routes | Sospensione per Strade Dissestate | Kötü yollar için |
| | Information | Information | Information | Informazioni | Açıklama |
| | In Preparation | In Vorbereitung | En préparation | In Preparazione | Hazırlıkta |
| | While Stocks Last | Solange Vorrat reicht | Jusqu'à épuisement | Ad Esaurimento | Stok yettiği sürece |
| | Chassis No. | Fahrgestell Nr. | Chassis N° | N. di Telaio | Şase no. |
| 12345 → | Onwards | Von... | À partir de... | A partire da... | ... den itibaren |
| → 67890 | Up to | Bis... | Jusqu'à | Fino a... | ...e kadar |
| Incl. | Include | Inklusive | Inclus | Incluso | Dahil |
| Exc. | Except | Exklusive | Excepté | Eccetto | Hariç |
| | With | Mit | Avec | Con | İle |
| | Without | Ohne | Sans | Senza | ... Siz |
| OE = | Applicable OE Part No. | Anwendbare Originalteile Nr. | Pour Ref.Origine N° | Per Codice Originale | Uygulanan orijinal parça No: |
| | Full Extended Length | Volle ausgezogene Länge | Longeur détendue | Lunghezza massima in estensione | Tam açılımsı vaziyette uzunluğu |
| | Available for unsealed strut only | Nur für verschraubte Federbeine | Valable pour jambe de force non sertie | Disponibile Solo per Sospensioni Non Sigillate | Yalnız vidalı botiller için |
| | Reuse OE Parts | Original Anbauteile wieder verwenden | Réutiliser pièces d'origine | Riutilizzare Le parti Originali | Orijinal bağlantı parçaları tekrar kullanılmalı |
| SP-001 | SP-001 is available to replace the old spring seat if damaged or unable to be reused. | SP-001 ist zu verwenden, wenn alter Federteller defekt ist und nicht wieder verwendet werden kann. | SP-001 est valable pour remplacer celle d'origine si endommagée ou inutilisable | SP-001 E' disponibile in sostituzione della vecchia sede molla se danneggiata o non più riutilizzabile. | Eski yaycanağı bir daha kullanılmıyacak kadar bozulmussa SP-001 kullanılır. |
| SG-701 SG-703 SG-704 | SG-701/ SG-703/ SG-704 is available to replace the old spring seat if damaged or unable to be reused. | SG-701/ SG-703/ SG-704 ist zu verwenden, wenn alter Federteller defekt ist und nicht wieder verwendet werden kann. | SG-701/ SG-703/ SG-704 est valable pour remplacer celle d'origine si endommagée ou inutilisable | SG-701/ SG-703/ SG-704 E' disponibile in sostituzione della vecchia sede molla se danneggiata o non più riutilizzabile. | Eski yaycanağı bir daha kullanılmıyacak kadar bozulmussa SG-701/ SG-703/ SG-704 kullanılır. |
| RN-001 RN-002 | RN-001/RN-002 is available to replace the old locking ring if damaged or unable to be reused. | RN-001/RN-002 ist zu verwenden wenn alter Sicherungsring defekt ist und nicht wieder verwendet werden kann. | RN-001/RN-002 est valable pour remplacer celle d'origine si endommagée ou inutilisable. | RN-001/RN-002 E' disponibile in sostituzione della vecchia ghiera di serraggio se danneggiata o non più riutilizzabile. | Eski emniyet halkası birdaha kullanılmıyacak kadar bozulmussa RN-001/RN-002 kullanılır. |
| | Protection Kit | Protection Kit | Kit de Protection | Kit di Protezione | Koruma seti |
| | Suspension Mounting Kit | Domlager Kit | Semelle de Suspension | Kit di Montaggio | Süspansiyon bağlantı takımı |
| | Bearing | Lager | Roulement | Cuscinetto | Bilyeli yatak |
| ! | Packed with shock absorbers | Im Lieferumfang enthalten | Inclus dans la boîte | Incluso nell'imballo dell'ammortizzatore | Amortisör kutusuyla paketlenmiş |
| | Mounting | Befestigung | Fixation | Montaggio | Mounting |
| | Upper Stem | Oberer Bolzen | Tige supérieure | Perno superiore | Üst mil |
| | Lower Stem | Unterer Bolzen | Tige inférieure | Perno inferiore | Alt mil |
| | Eying | Auge | Oeil | Occhiello | Halka bağlantı |
| | Eying with Steel Bushing | Auge mit Metallbuchse | Oeil avec bague acier | Occhiello con boccia metallica | Metal burçlu halka bağlantı |
| | Eying with Crosspin | Auge mit Gabelbolzen | Tige traversante | Occhiello con staffa | Çatal pimli halka bağlantı |
| | Special Mounting | Besondere Befestigung | Fixation spéciale | Montaggio speciale | Özel bağlantı |
| | Cartridge | Federbeinpatrone | Cartouche | Cartuccia | Botil |
| | Sealed Strut | Komplettes Federbein | Jambe de force | Ammortizzatore completo | Komple botil kovanlı |
| R | For the right side | Rechte Seite | Côté droit | Lato destro | Sag taraf için |
| L | For the left side | Linke Seite | Côté gauche | Lato sinistro | Sol taraf için |

Index

| | | | |
|--|----------------|---|----------------|
| New Additions | 12-25 | LDV Commercial (GB) | 186 |
| Alfa Romeo (I) | 27-31 | Lexus (J) | 186-188 |
| Audi (D) | 31-51 | Mazda (J) | 188-198 |
| Austin-Rover Group (GB) | 51-52 | Mercedes Benz (D) | 199-216 |
| Auto Bianchi (I) | 52 | Mercury (US) → Ford Mercury (US) | 143-144 |
| Bedford (GB) | 53-54 | Mini (D) | 216-217 |
| BMW (D) | 54-77 | Mitsubishi (J) | 218-232 |
| Buick (US) → General Motors (US) | 144 | Moskwitch (RUS) | 232 |
| Chevrolet-Daewoo (KO) | 78-81 | Nissan (J) | 233-249 |
| Chevrolet (US) → General Motors (US) | 144 | Opel (D) | 249-263 |
| Chrysler - Dodge - Plymouth (US) | 81-84 | Peugeot (F) | 263-283 |
| Citroën (F) | 84-102 | Piaggio (I) | 283 |
| Cupra (E) | 102 | Plymouth (US) → Chrysler - Dodge - Plymouth (US) | 81-84 |
| Dacia (R) | 102-104 | Pontiac (US) → General Motors (US) | 145 |
| Daewoo (KO) → Chevrolet-Daewoo (KO) | 78-81 | Porsche (D) | 284 |
| Daihatsu (J) | 105-108 | Proton (MA) | 284 |
| Dodge (US) → Chrysler - Dodge - Plymouth (US) | 81-84 | Renault (F) | 284-312 |
| DS (F) | 108-109 | Rover (GB) | 313-314 |
| Fiat (I) | 109-123 | Saab (S) | 314-316 |
| Fiat Polski (PL) | 123 | Santana (E) → Suzuki (J) | 341-347 |
| Ford (Europe) | 123-143 | Seat (E) | 316-325 |
| Ford Mercury (US) | 143-144 | Skoda (CS) | 325-332 |
| Freight Rover (GB) → Austin-Rover Group | 51-52 | Smart (D) | 333-334 |
| Gaz (RUS) | 144 | SsangYong (KO) | 334-335 |
| General Motors - Autovaz (RUS) | 144 | Subaru (J) | 335-341 |
| General Motors (US) | 145 | Suzuki (J) | 341-347 |
| General Motors - Hummer (US) | 145 | Talbot (F) (GB) | 347 |
| GMC Truck (US) → General Motors (US) | 145 | Toyota (J) | 348-375 |
| Hillman (GB) → Talbot (F) (GB) | 347 | Vauxhall (GB) | 376-389 |
| Honda (J) | 146-153 | Volkswagen (D) | 389-421 |
| Hummer (US) → General Motors - Hummer (US) | 145 | Volvo (S) | 421-428 |
| Hyundai (KO) | 153-164 | Wartburg (D) | 429 |
| Isuzu (J) | 164-166 | ZAZ (UA) | 429 |
| Iveco (I) | 166-167 | AGX | 432-470 |
| Jaguar (GB) | 167 | Numerical Listing | 472-532 |
| Jeep (US) | 168-169 | Protection Kit | 534-551 |
| Kia (KO) | 169-178 | Suspension Mounting Kit | 552-581 |
| Lada (VAZ) (RUS) | 179 | Alternative P/No | 582 |
| Lancia (I) | 179-183 | Discontinued P/No | 582 |
| Land Rover (GB) | 183-186 | | |

Contents

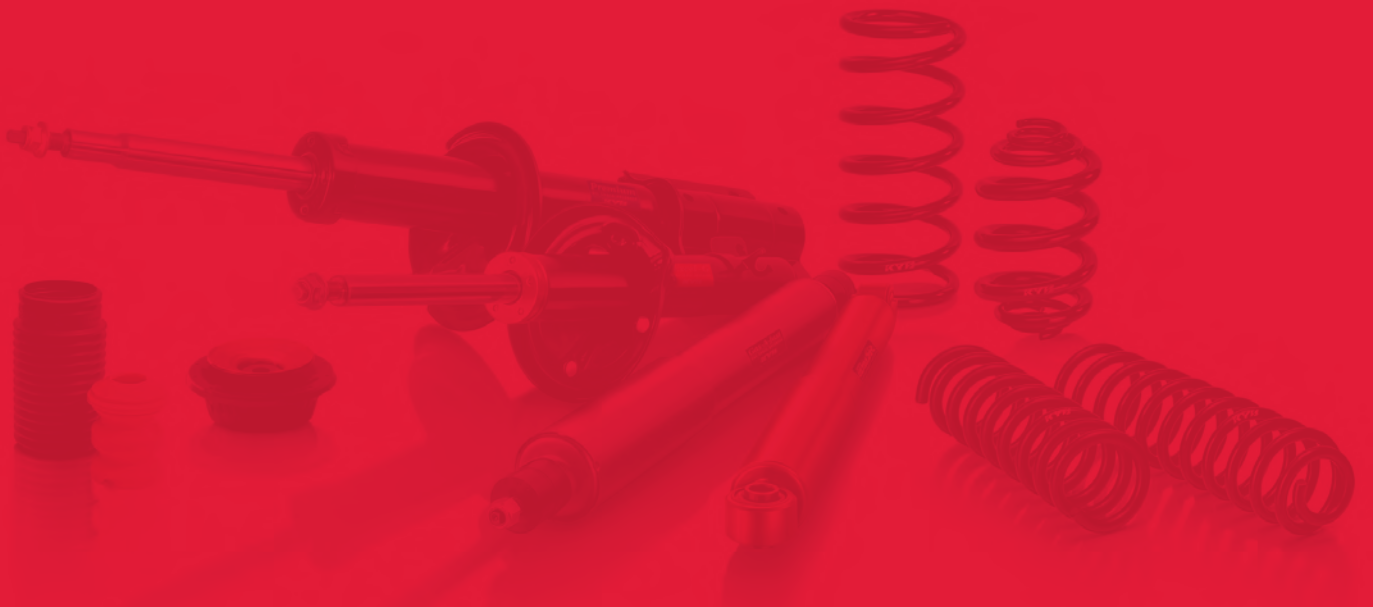

Shock Absorbers



Why choose KYB shock absorbers?

- ◆ **KYB** is Original Equipment Manufacturer to **1 in 5** of all cars produced in the world.
- ◆ **KYB** is one of the world's largest suppliers of shock absorbers in the world, manufacturing over 1 million shock absorbers every week.
- ◆ **KYB** offers a complete damping solution, with a wide range of shock absorbers, coil springs, suspension mounting kits and protection kits available.



**Original
Equipment
Manufacturer**

Safety: What do shock absorbers do?

- ◆ The shock absorber is the main element of suspension. It is the link between the wheel and chassis.
- ◆ Shock absorbers are critical to safety. With just one worn shock absorber, stopping distances at 30mph/50kph can increase by up to two metres.
- ◆ Shock absorbers keep a vehicle's tyres pushed into firm contact with the road, allowing you to steer and brake safely.



Why is it important to replace shock absorbers?

New KYB shock absorbers:

- ◆ Reduce braking distances.
- ◆ Increase road holding.
- ◆ Maintain comfort.
- ◆ Limit tyre wear.
- ◆ Reduce deterioration of other suspension components.

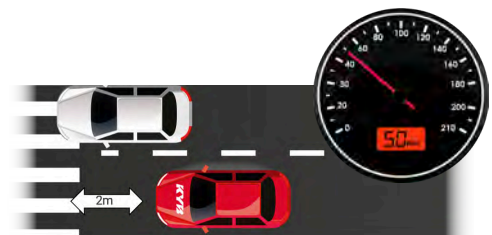

Shock Absorbers



The Signs of Worn Shock Absorbers

KYB recommends replacing shock absorbers every 80,000 kilometers but also when you notice one of the following symptoms :



Excessive bounce on bad roads



Vehicle nose dives while braking



Steering wheel vibration



Vehicle veers in a side wind



Excessive body roll



Unusual tyre wear



You should always replace shock absorbers in pairs. Replacing just one shock absorber can have adverse effects on steering, ride height and control of the vehicle.



Shock Absorbers



Which KYB product should I use?

KYB has over 4,000 shock absorbers available across several ranges. Each range offers a different type of technology and is designed to help you decide which type of technology is best. **Click on each of the logos for more information about the range.**

| Product | Type | | | |
|---------|--|---|---|---|
| | 44 Series Twin Tube Shock Absorber | 63 Series Twin Tube MacPherson Strut | 66 Series Twin Tube Strut Cartridge | |
| | 34 Series Twin Tube Shock Absorber | 22/33 Series Twin Tube MacPherson Strut | 36 Series Twin Tube Strut Cartridge | |
| | 55 Series Mono Tube Shock Absorber | | | |
| | 24 Series Mono Tube Shock Absorber | 32 Series Twin Tube MacPherson Strut | 35 Series Twin Tube Shock Absorber | 37 Series Twin Tube Strut Cartridge |
| | 74 Series Twin Tube Shock Absorber | 73 Series Twin Tube MacPherson Strut | 76 Series Twin Tube Strut Cartridge | |

Protection Kits

Protection Kits are a critical element for optimal shock absorbers. As the name suggests, they are designed to protect the shock absorber piston rod from any road debris, therefore increasing the shock absorber lifespan.

Why choose KYB Protection Kits?



- ◆ Protection kits increase the life of the shock absorber by preventing dust and moisture from damaging the piston surface and seal.
- ◆ They also protect the piston rod from damage and corrosion from stones and road pollution.
- ◆ The bump stop limits the suspension travel in the compression phase.



Suspension Mounting Kits

Suspension Mounting Kits act as a vital link between the shock absorber and the vehicle chassis.

Why choose KYB Suspension Mounting Kits?



- ◆ Reduces suspension vibration and noise.
- ◆ Improves steering.
- ◆ Eliminates noises while steering.
- ◆ Keeps the shock absorber positioned correctly for optimal steering geometry.



Coil Springs

Coil springs support a vehicles weight and compress to absorb the impact of any bumps or jolts in the road surface. Coil springs also maintain the correct ride height of the vehicle.



When should coil springs be replaced?

It is recommended that coil springs are checked annually to determine their condition and they should be changed after 80,000km. Worn springs will begin to compromise the safety of the vehicle, contributing to longer braking distances, reduced road holding ability, increased tyre wear and less responsive steering.



Why replace coil springs?

- ◆ Maintain comfort, performance and safety.
- ◆ Correct steering geometry.
- ◆ Correct vehicle ride height.
- ◆ Reduce deterioration of shock absorbers.



Coil springs should **always** be replaced in pairs.

Suspension Visual Check

KYB recommends replacing all suspension components at the same time.

Protection Kit

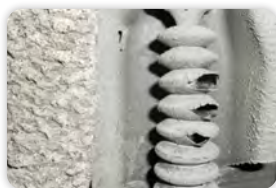

Pitted dust cover



Loose bump stop



Broken bump stop

Coil Springs



Rust



Broken



Damaged mounting

KYB Product



Torn Strut Insulator



Broken Bearing

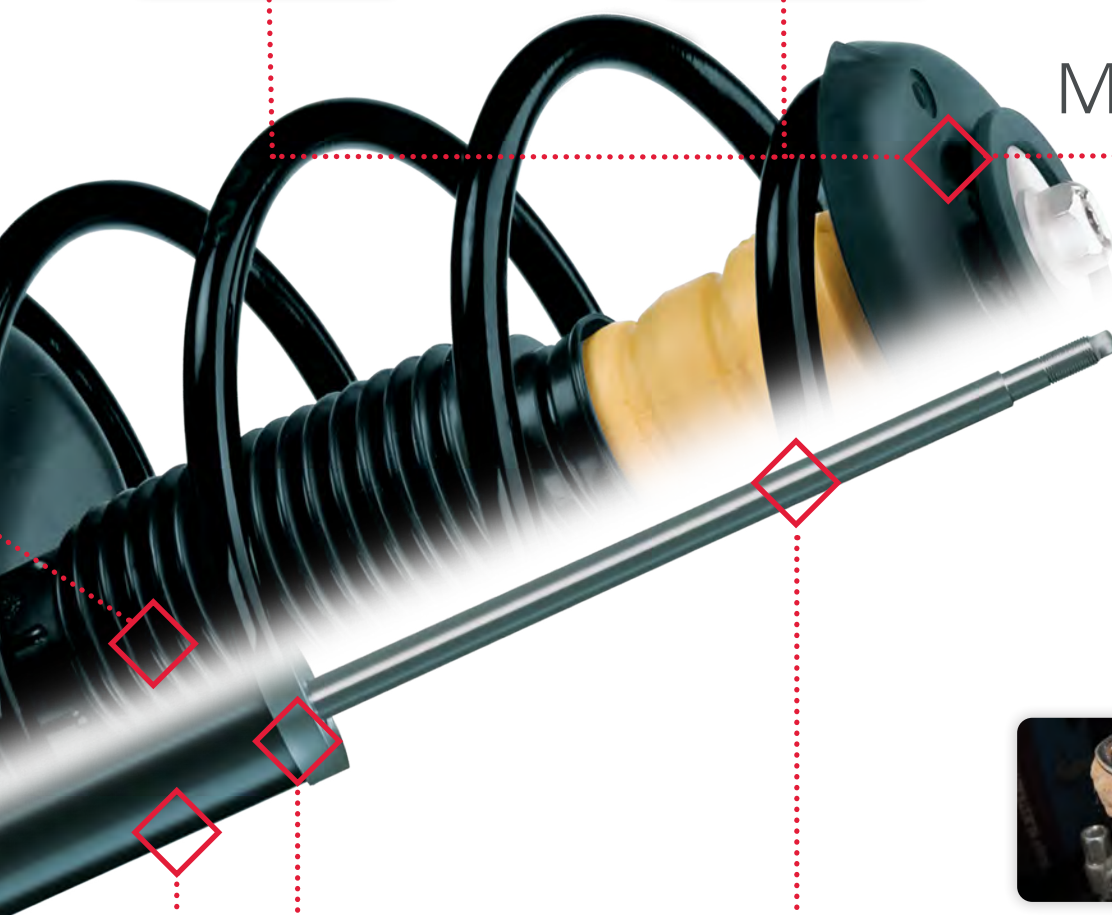

Mounting Kit



Rust



Rusted body



Damaged piston rod



Damaged body



Oil leakage

Shock Absorbers



KYB Suspension Solutions

KYB has a number of support tools available, specifically designed to make fitting suspension components easier and quicker.

Support



Fitting Videos

With over 6 million views, **KYB** has created fitting videos for vehicles that are known to be difficult when fitting suspension. These can be found on YouTube: youtube.com/KYBEurope.



Online Catalogue

KYB part numbers are easy to find using our free online catalogue. Enter either the vehicle model, VIN or the registration number and you will be shown the correct **KYB** part number. As of 2021, **KYB** was awarded a Premier Data Supplier status by TecDoc and was the first shock absorber manufacturer to be awarded this status.



QR Codes

Many **KYB** shock absorbers have a label with a spanner icon and QR Code on them - scanning it with your smartphone camera will give access to part specific fitting instructions and videos.

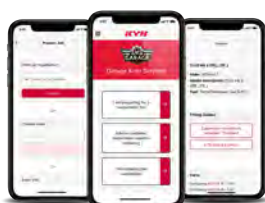

KYB Suspension Solutions App

KYB has a free App specifically designed to help technicians identify and sell replacement parts for vehicles with worn suspension components.



360° Product Images

KYB has the widest range of 360° product images in the European aftermarket. The user can rotate and zoom in on the image, and compare to the unit being replaced. This ability to compare in detail helps to ensure the correct part is being chosen for the job, increasing efficiency and reducing returns. Now also available on TecDoc.



For more information, visit kyb-europe.com/support-zone

KYB Suspension Solutions App

KYB has developed an App, available to download from the App Store or Google Play, to aid technicians with the fitting of suspension components and to assist informing customers of the dangers of driving with worn suspension. All communication sent from the App can be customised with your logo. Each feature is designed to assist at every stage of the job:

1 Before the job

If a customer needs their suspension replacing, click "advise customer suspension requires replacing"

- ◆ Enter customer's details
- ◆ Select faulty parts and the symptoms.
- ◆ Add an image of the faulty part (optional)
- ◆ Preview the text message and send- these are free and shown to be from the workshop.

The text contains a report. This report, fully branded as the garage, will:

- ◆ Contain all the information inputted by the technician.
- ◆ Show the benefits of replacing suspension
- ◆ A "Call" button- if clicked, they are able to call the workshop directly.

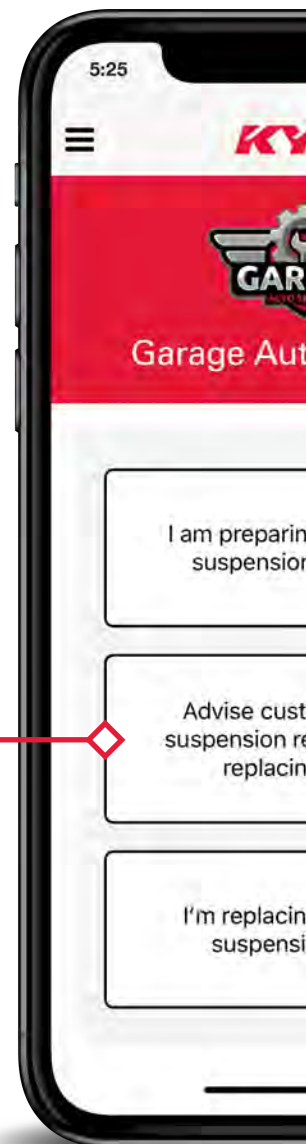

2 During the job

Click "I am preparing for a suspension job".

Enter a registration number, vehicle make or VIN. This will give you access to:



Fitting Videos



Fitting Guides



Part Numbers

There will also be an estimate for the time needed to complete the job, allowing you to quote reliably.

3 After the job

Click "I'm replacing the suspension".

- ◆ Enter customer's details
- ◆ Select faulty parts and the symptoms.
- ◆ Add a before and after image (optional).
- ◆ Preview the text message and send- these are free and shown to be from the workshop.





NEW ADDITIONS

New Part No/Neue Teile No/ Nouveau No.

◇ : in preparation/in Vorbereitung/en études

| KYB | VEHICLE FAHRZEUG VEHICULE | KYB | VEHICLE FAHRZEUG VEHICULE |
|------------|--|-------------|---|
| # 5538003 | Alfa Romeo Giulia (952_) [10.15 -] - R | # 3348027 | BMW 1 Series (F21, F20) [11.10 -] - F |
| # 3458002 | Alfa Romeo Mito (955) [4.11 -] - R | # 3348028 | BMW 1 Series (F21, F20) [11.11 -] - F |
| # 5538004 | Alfa Romeo Stelvio (949_) [12.16 -] - R | # 3348044 | BMW 1 Series (F21, F20) [1.11 -] - F(L) |
| # 3348020 | Audi A1 (8X1, 8XK), A1 Sportback (8XA, 8XF) [3.12 - 10.18] - F | # 3348043 | BMW 1 Series (F21, F20) [1.11 -] - F(R) |
| # 3348074 | Audi A1 City Carver (GBH) [7.19 -] - F | # 3348046 | BMW 1 Series (F21, F20) [2.12 -] - F(L) |
| # 3348090 | Audi A1 City Carver (GBH) [7.19 -] - F | # 3348045 | BMW 1 Series (F21, F20) [2.12 -] - F(R) |
| # 3348074 | Audi A1 Sportback (GBA) [7.18 -] - F | # 3348026 | BMW 2 Series (F22) [7.14 -] - F(L) |
| # 3348090 | Audi A1 Sportback (GBA) [7.18 -] - F | # 3348025 | BMW 2 Series (F22) [7.14 -] - F(R) |
| # 3348039 | Audi A3 (8V1, 8VK), A3 Sportback (8VA, 8VF), A3 Limousine (8VS, 8VM) [4.12 -] - F | # 3348027 | BMW 2 Series (F22) [10.13 -] - F |
| # 3358015 | Audi A3 (8V1, 8VK), A3 Sportback (8VA, 8VF), A3 Limousine (8VS, 8VM) [4.12 -] - F | # 3348028 | BMW 2 Series (F22) [10.13 -] - F |
| # 3448024 | Audi A3 (8V1, 8VK), A3 Sportback (8VA, 8VF), A3 Limousine (8VS, 8VM) [4.12 -] - R | # 3348046 | BMW 2 Series (F22) [9.15 -] - F(L) |
| # 3448025 | Audi A3 (8V1, 8VK), A3 Sportback (8VA, 8VF), A3 Limousine (8VS, 8VM) [4.12 -] - R | # 3348045 | BMW 2 Series (F22) [9.15 -] - F(R) |
| # 3348039 | Audi A3 Cabriolet (8V7, 8VE) [10.13 -] - F | # 3348027 | BMW 2 Series (F23) [3.14 -] - F |
| # 3358015 | Audi A3 Cabriolet (8V7, 8VE) [10.13 -] - F | # 3348028 | BMW 2 Series (F23) [11.14 -] - F |
| 3430023 | Audi A3 Cabriolet (8V7, 8VE) [5.17 -] - R | # 3348046 | BMW 2 Series (F23) [7.15 -] - F(L) |
| # 3448024 | Audi A3 Cabriolet (8V7, 8VE) [5.17 -] - R | # 3348045 | BMW 2 Series (F23) [7.15 -] - F(R) |
| # 3448025 | Audi A3 Cabriolet (8V7, 8VE) [5.17 -] - R | # 3348101 ◇ | BMW 2 Series Active Tourer (F45) [11.13 -] - F(L) |
| # 3418005 | Audi A4 (8W2, 8WC), A4 Avant (8W5, 8WD) [5.15 -] - F | # 3348100 ◇ | BMW 2 Series Active Tourer (F45) [11.13 -] - F(R) |
| # 3418005 | Audi A4 Allroad (8WH, 8WJ) [1.16 - 4.20] - F | # 3448034 | BMW 2 Series Active Tourer (F45) [11.13 -] - R |
| # 3418006 | Audi A6 (4A2), A6 Avant (4A5), A6 Allroad (4AH) [2.18 -] - F | # 3348101 ◇ | BMW 2 Series Gran Tourer (F46) [7.14 -] - F(L) |
| # 3358015 | Audi Q2 (GAB, GAG) [6.16 -] - F | # 3348100 ◇ | BMW 2 Series Gran Tourer (F46) [7.14 -] - F(R) |
| # 3448023 | Audi Q2 (GAB, GAG) [7.16 -] - R | # 3448034 | BMW 2 Series Gran Tourer (F46) [7.14 -] - R |
| # 3448027 | Audi Q2 (GAB, GAG) [6.16 -] - R | # 3348026 | BMW 3 Series (F30, F80) [7.12 - 10.18] - F(L) |
| # 3358020 | Audi Q3 (F3B), Q3 Sportback (F3N) [7.18 -] - F | # 3348025 | BMW 3 Series (F30, F80) [7.12 - 10.18] - F(R) |
| # 3448024 | Audi Q3 (F3B), Q3 Sportback (F3N) [7.18 -] - R | # 3348027 | BMW 3 Series (F30, F80) [11.11 - 10.18] - F |
| # 3418006 | Audi Q5, Q5 Sportback (FY_) [6.16 -] - F | # 3348028 | BMW 3 Series (F30, F80) [11.11 - 10.18] - F |
| # 3418007 | Audi Q5, Q5 Sportback (FY_) [6.16 -] - R | # 3348026 | BMW 3 Series Touring (F31) [3.13 - 6.19] - F(L) |
| # 3318000 | Audi Q7 (4MB, 4MG) [1.15 -] - F | # 3348025 | BMW 3 Series Touring (F31) [3.13 - 6.19] - F(R) |
| # 3348039 | Audi S3 (8V_) [11.12 -] - F | # 3348027 | BMW 3 Series Touring (F31) [7.12 - 6.19] - F |
| # 3358015 | Audi S3 (8V_) [11.12 -] - F | # 3348028 | BMW 3 Series Touring (F31) [3.13 - 6.19] - F |
| # 3448024 | Audi S3 (8V_) [11.12 -] - R | 3448018 | BMW 3 Series Touring (F31) [7.12 - 6.19] - R |
| # 3418005 | Audi S4 (8W2, 8WC, 8W5, 8WD) [5.16 -] - F | # 3348027 | BMW 3 Series Gran Turismo (F34) [3.13 -] - F |
| # 3418006 | Audi S6 (4A*, C8) [3.19 -] - F | # 3348044 | BMW 3 Series Gran Turismo (F34) [11.12 -] - F(L) |
| # 3358021 | Audi TT Coupé (FV3) [7.14 -] - F | # 3348043 | BMW 3 Series Gran Turismo (F34) [11.12 -] - F(R) |
| # 3448024 | Audi TT Coupé (FV3) [7.14 -] - R | 3448018 | BMW 3 Series Gran Turismo (F34) [11.12 -] - R |
| # 3358021 | Audi TT Roadster (FV9) [11.14 -] - F | # 3348027 | BMW 4 Series (F32) [7.13 -] - F |
| # 3448024 | Audi TT Roadster (FV9) [11.14 -] - R | # 3348028 | BMW 4 Series (F32) [7.13 -] - F |
| | | # 3348044 | BMW 4 Series (F32) [7.13 -] - F(L) |
| | | # 3348043 | BMW 4 Series (F32) [7.13 -] - F(R) |
| | | # 3348027 | BMW 4 Series (F33) [10.13 -] - F |
| | | # 3348028 | BMW 4 Series (F33) [10.13 -] - F |
| | | # 3348044 | BMW 4 Series (F33) [1.14 -] - F(L) |
| | | # 3348043 | BMW 4 Series (F33) [1.14 -] - F(R) |
| | | # 3348027 | BMW 4 Series Gran Coupe (F36) [3.14 -] - F |

NEW ADDITIONS

New Part No./Neue Teile No/ Nouveau No.

◇ : in preparation/in Vorbereitung/en études

| KYB | VEHICLE FAHRZEUG VEHICULE | KYB | VEHICLE FAHRZEUG VEHICULE |
|-------------|--|------------|---|
| # 3348028 | BMW 4 Series Gran Coupe (F36) [3.14 -] - F | # 3348099 | Citroën C4 Cactus [2.18 -] - F(L) |
| # 3348044 | BMW 4 Series Gran Coupe (F36) [7.14 -] - F(L) | # 3348098 | Citroën C4 Cactus [2.18 -] - F(R) |
| # 3348043 | BMW 4 Series Gran Coupe (F36) [7.14 -] - F(R) | # 3438010 | Citroën C4 Cactus [9.14 - 1.18] - R |
| # 3348101 ◇ | BMW X1 (F48) [11.14 -] - F(L) | 3438001 | Citroën C4 Cactus [2.18 -] - R |
| # 3348100 ◇ | BMW X1 (F48) [11.14 -] - F(R) | # 3348095 | Citroën C5 Aircross [11.18 -] - F |
| # 3448034 | BMW X1 (F48) [11.14 -] - R | 3448001 | Citroën C5 Aircross [11.18 -] - R |
| # 3348101 ◇ | BMW X2 (F39) [3.20 -] - F(L) | # 3448033 | Citroën C5 Aircross [11.18 -] - R |
| # 3348100 ◇ | BMW X2 (F39) [3.20 -] - F(R) | 339708 | Citroën DS3 [1.13 - 7.15] - F(L) |
| # 3448034 | BMW X2 (F39) [11.17 -] - R | 339707 | Citroën DS3 [1.13 - 7.15] - F(R) |
| # 3418001 | BMW X5 (F15) [8.13 - 7.18] - F | # 3348038 | Citroën DS5 [11.11 - 7.15] - F(L) |
| # 3418003 | BMW X5 (F15) [8.13 - 7.18] - R(L) | # 3348037 | Citroën DS5 [11.11 - 7.15] - F(R) |
| # 3418002 | BMW X5 (F15) [8.13 - 7.18] - R(R) | # 3348084 | Citroën |
| # 3418001 | BMW X6 (F16) [8.14 -] - F | | Jumpy / Dispatch / Spacetourer (V_) [4.16 -] - F |
| # 3418003 | BMW X6 (F16) [8.14 -] - R(L) | # 3348085 | Citroën |
| # 3418002 | BMW X6 (F16) [8.14 -] - R(R) | | Jumpy / Dispatch / Spacetourer (V_) [4.16 -] - F |
| # 3320036 | Chevrolet - Daewoo | # 3458001 | Citroën |
| | Matiz / Spark (M200, M250) [3.05 - 12.08] - F(L) | | Jumpy / Dispatch / Spacetourer (V_) [4.16 -] - R |
| # 3320035 | Chevrolet - Daewoo | # 3338034 | Dacia Dokker, Dokker Express [11.12 -] - F |
| | Matiz / Spark (M200, M250) [3.05 - 12.08] - F(R) | 338737 | Dacia Duster (HM) [10.17 -] - F |
| # 3330080 | Chevrolet - Daewoo | 338738 | Dacia Duster (HM) [10.17 -] - R |
| | Matiz / Spark (M300) [3.10 -] - F(L) | 343827 | Dacia Duster (HM) [10.17 -] - R |
| # 3330079 | Chevrolet - Daewoo | # 3338023 | Dacia Lodgy [3.12 -] - F |
| | Matiz / Spark (M300) [3.10 -] - F(R) | # 3338034 | Dacia Lodgy [3.12 -] - F |
| # 3340214 | Chevrolet - Daewoo Trax [12.12 -] - F(L) | # 338112 | Dacia Logan (LS) [9.04 -] - F |
| # 3340213 | Chevrolet - Daewoo Trax [12.12 -] - F(R) | 343836 | Dacia Sandero II [9.15 -] - R |
| 3440035 | Chevrolet - Daewoo Trax [12.12 -] - R | # 3338042 | Dacia Sandero Stepway II [10.12 -] - F |
| # 3418008 ◇ | Citroën Berlingo (K9) [6.18 -] - R | 338749 | Dacia Sandero Stepway II [8.18 -] - F |
| # 3338058 | Citroën C3 III (SX_, SY_) [7.16 -] - F(L) | 338759 | Dacia Sandero Stepway II [8.18 -] - F |
| # 3338057 | Citroën C3 III (SX_, SY_) [7.16 -] - F(R) | 343833 | Dacia Sandero Stepway II [8.18 -] - R |
| # 3348099 | Citroën C3 III (SX_, SY_) [7.16 -] - F(L) | # 343834 | Dacia Sandero Stepway II [10.12 -] - R |
| # 3348098 | Citroën C3 III (SX_, SY_) [7.16 -] - F(R) | 3348013 | DS 3 (SA_, SB_) [7.15 - 7.19] - F(L) |
| 3438000 | Citroën C3 III (SX_, SY_) [7.16 -] - R | 3348012 | DS 3 (SA_, SB_) [7.15 - 7.19] - F(R) |
| # 3338050 | Citroën C3 Aircross II (2R_, 2C_) [6.17 -] - F(L) | 339708 | DS 3 (SA_, SB_) [4.15 - 7.19] - F(L) |
| # 3338049 | Citroën C3 Aircross II (2R_, 2C_) [6.17 -] - F(R) | 339707 | DS 3 (SA_, SB_) [4.15 - 7.19] - F(R) |
| # 3338052 | Citroën C3 Aircross II (2R_, 2C_) [6.17 -] - F(L) | 339795 | DS 3 (SA_, SB_) [4.15 - 7.19] - F(L) |
| # 3338051 | Citroën C3 Aircross II (2R_, 2C_) [6.17 -] - F(R) | 339794 | DS 3 (SA_, SB_) [4.15 - 7.19] - F(R) |
| 3438001 | Citroën C3 Aircross II (2R_, 2C_) [6.17 -] - R | 339801 | DS 3 (SA_, SB_) [4.15 - 7.19] - F(L) |
| # 3348059 | Citroën C4 II (B7) [11.09 -] - F(L) | 339800 | DS 3 (SA_, SB_) [4.15 - 7.19] - F(R) |
| # 3348058 | Citroën C4 II (B7) [11.09 -] - F(R) | 3448000 | DS 3 (SA_, SB_) [4.15 - 7.19] - R |
| 339829 | Citroën C4 II (B7) [11.09 -] - F(L) | 339829 | DS 4 [7.15 -] - F(L) |
| 339828 | Citroën C4 II (B7) [11.09 -] - F(R) | 339828 | DS 4 [7.15 -] - F(R) |
| 345085 | Citroën C4 II (B7) [10.10 -] - R | 345085 | DS 4 [7.15 -] - R |
| # 3338058 | Citroën C4 Cactus [2.18 -] - F(L) | # 3348038 | DS 5 [4.15 -] - F(L) |
| # 3338057 | Citroën C4 Cactus [2.18 -] - F(R) | # 3348037 | DS 5 [4.15 -] - F(R) |

NEW ADDITIONS

New Part No/Neue Teile No/ Nouveau No.

◇ : in preparation/in Vorbereitung/en études

| KYB | VEHICLE FAHRZEUG VEHICULE | KYB | VEHICLE FAHRZEUG VEHICULE |
|-------------|--|-------------|---|
| 349156 | DS 5 [4.15 -] - R | # 3330049 | Hyundai Elantra (MD, UD) [9.10 - 9.13] - F(L) |
| # 3348097 | Fiat 500 L (351_, 352_) [9.12 -] - F(L) | # 3330048 | Hyundai Elantra (MD, UD) [9.10 - 9.13] - F(R) |
| # 3348096 | Fiat 500 L (351_, 352_) [9.12 -] - F(R) | 3430029 | Hyundai i10 III (AC3, AI3) [9.19 -] - R |
| # 3458002 | Fiat 500 L (351_, 352_) [9.12 -] - R | # 3430050 | Hyundai i20 II (GB, IB) [11.14 -] - R |
| # 3348077 | Fiat 500X (334_) [9.14 -] - F(L) | # 3430064 | Hyundai i20 Active (IB, GB) [9.15 - 3.18] - R |
| # 3348076 | Fiat 500X (334_) [9.14 -] - F(R) | # 3330122 ◇ | Hyundai ix20 (JC) [11.10 - 3.15] - F(L) |
| # 3348079 | Fiat 500X (334_) [9.14 -] - R(L) | # 3330121 ◇ | Hyundai ix20 (JC) [11.10 - 3.15] - F(R) |
| # 3348078 | Fiat 500X (334_) [9.14 -] - R(R) | # 3340163 | Hyundai i30 II (GD) [11.11 -] - F(L) |
| # 3348050 | Fiat Croma II (194) [6.05 -] - F(L) | # 3340162 | Hyundai i30 II (GD) [11.11 -] - F(R) |
| # 3348049 | Fiat Croma II (194) [6.05 -] - F(R) | # 3340163 | Hyundai i30 CW II (GD) [6.12 -] - F(L) |
| # 3348053 | Fiat Panda (312_, 319_) [2.12 -] - F(L) | # 3340162 | Hyundai i30 CW II (GD) [6.12 -] - F(R) |
| # 3348052 | Fiat Panda (312_, 319_) [2.12 -] - F(R) | # 3340163 | Hyundai i30 Coupé [5.13 -] - F(L) |
| # 3348067 | Fiat Panda (312_, 319_) [6.12 -] - F(L) | # 3340162 | Hyundai i30 Coupé [5.13 -] - F(R) |
| # 3348066 | Fiat Panda (312_, 319_) [6.12 -] - F(R) | # 3340137 ◇ | Hyundai i40 (VF) [3.12 -] - F(L) |
| 335803 | Fiat Talento (296) [6.16 -] - F | # 3340136 ◇ | Hyundai i40 (VF) [3.12 -] - F(R) |
| 344803 | Fiat Talento (296) [6.16 -] - R | # 3340137 ◇ | Hyundai i40 CW (VF) [7.11 - 12.14] - F(L) |
| # 3458002 | Fiat Tipo (356) [3.16 -] - R | # 3340136 ◇ | Hyundai i40 CW (VF) [7.11 - 12.14] - F(R) |
| # 3348033 | Ford B-Max (JK) [10.12 -] - F(L) | # 3430072 | Hyundai Kona (OS_) [7.17 -] - R |
| # 3348032 | Ford B-Max (JK) [10.12 -] - F(R) | # 3440114 | Hyundai Kona (OS_) [6.17 -] - R |
| 3438002 | Ford B-Max (JK) [10.12 -] - R | # 3330057 | Hyundai Matrix (FC) [6.01 - 8.10] - R(L) |
| # 554402 | Ford C-Max II (DXA/CB7, DXA/CEU) [1.15 -] - R | # 3330056 | Hyundai Matrix (FC) [6.01 - 8.10] - R(R) |
| # 3348042 | Ford Fiesta VI (CB1, CCN) [1.09 -] - F(L) | # 3340195 | Hyundai Santa Fe III (DM) [9.12 -] - F(L) |
| # 3348041 | Ford Fiesta VI (CB1, CCN) [1.09 -] - F(R) | # 3340194 | Hyundai Santa Fe III (DM) [9.12 -] - F(R) |
| # 3348057 | Ford Fiesta VI (CB1, CCN) [3.13 -] - F(L) | # 3410081 | Hyundai Santa Fe III (DM) [9.12 -] - R |
| # 3348056 | Ford Fiesta VI (CB1, CCN) [3.13 -] - F(R) | # 3440072 | Hyundai Santa Fe III (DM) [9.12 -] - R |
| # 3348042 | Ford Fiesta [4.10 -] - F(L) | # 344663 | Hyundai Santa Fe III (DM) [9.12 -] - R |
| # 3348041 | Ford Fiesta [4.10 -] - F(R) | # 3340195 | Hyundai Grand Santa Fe [6.13 -] - F(L) |
| # 3348048 | Ford Kuga II (DM2) [10.12 - 9.14] - F(L) | # 3340194 | Hyundai Grand Santa Fe [6.13 -] - F(R) |
| # 3348047 | Ford Kuga II (DM2) [10.12 - 9.14] - F(R) | # 3440072 | Hyundai Grand Santa Fe [6.13 -] - R |
| # 3440125 | Ford Mondeo V (CE, CD, CF) [9.12 -] - R | 348007 | Hyundai Solaris V [1.17 -] - R |
| # 3348033 | Ford Tourneo Courier (B460) [2.14 -] - F(L) | # 3340220 ◇ | Hyundai Sonata VI (YF) [6.09 - 5.11] - F(L) |
| # 3348032 | Ford Tourneo Courier (B460) [2.14 -] - F(R) | # 3340219 ◇ | Hyundai Sonata VI (YF) [6.09 - 5.11] - F(R) |
| 3438002 | Ford Tourneo Courier (B460) [2.14 -] - R | # 3440062 | Hyundai Tucson (TL, TLE) [6.15 -] - R |
| # 3440074 | Ford Transit [8.13 -] - R | # 3440122 | Hyundai Tucson (TL, TLE) [10.18 -] - R |
| # 3348033 | Ford Transit Courier (B460) [2.14 -] - F(L) | # 3440122 | Hyundai Tucson (NX4E, NX4A) [11.20 -] - R |
| # 3348032 | Ford Transit Courier (B460) [2.14 -] - F(R) | # 3330074 | Hyundai Veloster (FS) [3.11 - 9.11] - F(L) |
| 3438002 | Ford Transit Courier (B460) [2.14 -] - R | # 3330073 | Hyundai Veloster (FS) [3.11 - 9.11] - F(R) |
| # 340106 | Ford - Mercury Ranger (TKE) [4.11 -] - F | # 3330094 | Hyundai Veloster (FS) [10.11 -] - F(L) |
| # 3348055 | Honda Civic IX (FK) [2.12 -] - F(L) | # 3330093 | Hyundai Veloster (FS) [10.11 -] - F(R) |
| # 3348054 | Honda Civic IX (FK) [2.12 -] - F(R) | 554384 | Hyundai Veloster (FS) [3.11 -] - R |
| # 3430036 | Honda Civic X (FC_, FK_) [8.16 -] - R | # 349223 | Isuzu D-Max II (TFR86J) [6.12 -] - R |
| # 3410047 ◇ | Honda CR-V IV (RE) [10.12 -] - R | # 3348079 | Jeep Renegade (BU, B1) [7.14 -] - R(L) |
| # 3330053 | Hyundai Accent III (MC) [11.05 - 11.10] - F(L) | # 3348078 | Jeep Renegade (BU, B1) [7.14 -] - R(R) |
| # 3330052 | Hyundai Accent III (MC) [11.05 - 11.10] - F(R) | # 5530007 | Kia Carens III [3.13 - 7.16] - R |

NEW ADDITIONS

New Part No/Neue Teile No/ Nouveau No.

◇ : in preparation/in Vorbereitung/en études

| KYB | VEHICLE FAHRZEUG VEHICULE | KYB | VEHICLE FAHRZEUG VEHICULE |
|-------------|--|-------------|---|
| # 3340222 ◇ | Kia Cee'd (ED) [1.09 - 12.12] - F(L) | # 3358018 | Land Rover |
| # 3340221 ◇ | Kia Cee'd (ED) [1.09 - 12.12] - F(R) | | Range Rover Evoque (L538) [6.11 - 12.19] - R(R) |
| # 3340222 ◇ | Kia Cee'd SW (ED) [1.08 - 12.12] - F(L) | 551131 | Lexus IS III (_E3_) [4.13 -] - F(L) |
| # 3340221 ◇ | Kia Cee'd SW (ED) [1.08 - 12.12] - F(R) | 551130 | Lexus IS III (_E3_) [4.13 -] - F(R) |
| # 3340222 ◇ | Kia ProCee'd (ED) [2.08 - 2.13] - F(L) | # 5540004 | Lexus IS III (_E3_) [4.13 -] - R |
| # 3340221 ◇ | Kia ProCee'd (ED) [2.08 - 2.13] - F(R) | # 3350039 | Lexus NX (_Z1_) [7.14 -] - F(L) |
| # 3340163 | Kia Cee'd (JD) [5.12 -] - F(L) | # 3350038 | Lexus NX (_Z1_) [7.14 -] - F(R) |
| # 3340162 | Kia Cee'd (JD) [5.12 -] - F(R) | 349024 | Lexus NX (_Z1_) [7.14 -] - R |
| # 3340163 | Kia Cee'd Sportswagon (JD) [9.12 -] - F(L) | # 3330084 | Mazda 2, Demio (DL, DJ) [8.14 -] - F(L) |
| # 3340162 | Kia Cee'd Sportswagon (JD) [9.12 -] - F(R) | # 3330083 | Mazda 2, Demio (DL, DJ) [8.14 -] - F(R) |
| # 3340163 | Kia ProCee'd (JD) [3.13 -] - F(L) | # 3430045 ◇ | Mazda 2, Demio (DL, DJ) [8.14 -] - R |
| # 3340162 | Kia ProCee'd (JD) [3.13 -] - F(R) | # 3340036 | Mazda 3 (BM, BN) [7.13 -] - F(L) |
| # 3440114 | Kia Niro (DE) [8.18 -] - R | # 3340035 | Mazda 3 (BM, BN) [7.13 -] - F(R) |
| # 3440061 | Kia Optima (JF) [9.15 -] - R | # 3430041 | Mazda 3 (BM, BN) [7.13 -] - R |
| # 3440061 | Kia Optima Sportswagon (JF) [1.18 -] - R | # 3340139 | Mazda CX-3 (DK) [2.15 -] - F(L) |
| 343405 | Kia Picanto (JA) [3.17 -] - R | # 3340138 | Mazda CX-3 (DK) [2.15 -] - F(R) |
| # 3330053 | Kia Rio II (JB) [3.05 -] - F(L) | # 3430037 | Mazda CX-3 (DK) [2.15 -] - R |
| # 3330052 | Kia Rio II (JB) [3.05 -] - F(R) | # 3440013 | Mazda CX-5 (KE, GH) [2.15 - 2.17] - R |
| # 3430076 | Kia Rio IV (YB, SC, FB) [1.17 -] - R | # 3440013 | Mazda CX-5 (KF) [5.17 -] - R |
| 348007 | Kia Rio IV (SC, FB) [7.17 - 11.18] - R | # 3440014 | Mazda CX-5 (KF) [11.18 -] - R |
| # 3340195 | Kia Sorento II (XM) [10.12 -] - F(L) | # 3348061 | Mercedes Benz A-Class (W176) [6.12 - 5.18] - F(L) |
| # 3340194 | Kia Sorento II (XM) [10.12 -] - F(R) | # 3348060 | Mercedes Benz A-Class (W176) [6.12 - 5.18] - F(R) |
| # 3410081 | Kia Sorento II (XM) [10.12 -] - R | # 3348063 | Mercedes Benz A-Class (W176) [6.12 - 5.18] - F(L) |
| # 3440072 | Kia Sorento II (XM) [10.12 -] - R | # 3348062 | Mercedes Benz A-Class (W176) [6.12 - 5.18] - F(R) |
| # 344663 | Kia Sorento II (XM) [10.12 -] - R | # 3348065 | Mercedes Benz A-Class (W176) [6.12 - 5.18] - F(L) |
| # 3440126 ◇ | Kia Sorento III (UM) [1.15 -] - R | # 3348064 | Mercedes Benz A-Class (W176) [6.12 - 5.18] - F(R) |
| 349187 | Kia Sorento III (UM) [12.18 -] - R | # 5538001 | Mercedes Benz A-Class (W176) [6.12 - 5.18] - R |
| # 3330120 ◇ | Kia Soul I (AM) [2.09 -] - F(L) | # 5538002 | Mercedes Benz A-Class (W176) [6.12 - 5.18] - R |
| # 3330119 ◇ | Kia Soul I (AM) [2.09 -] - F(R) | # 3348061 | Mercedes Benz |
| # 3440062 | Kia Sportage IV (QL, QLE) [9.15 -] - R | | B-Class (W246, W242) [11.11 - 12.18] - F(L) |
| # 3440122 | Kia Sportage IV (QL, QLE) [9.15 -] - R | # 3348060 | Mercedes Benz |
| 348007 | Kia Stonic (YB) [7.17 -] - R | | B-Class (W246, W242) [11.11 - 12.18] - F(R) |
| # 3330122 ◇ | Kia Venga (YN) [2.10 - 12.15] - F(L) | # 3348063 | Mercedes Benz |
| # 3330121 ◇ | Kia Venga (YN) [2.10 - 12.15] - F(R) | | B-Class (W246, W242) [11.11 - 12.18] - F(L) |
| # 3338042 | Lada (VAZ) X Ray (GAB_) [2.16 -] - F | # 3348062 | Mercedes Benz |
| # 3358017 | Land Rover Discovery Sport (L550) [9.14 -] - F(L) | | B-Class (W246, W242) [11.11 - 12.18] - F(R) |
| # 3358016 | Land Rover Discovery Sport (L550) [9.14 -] - F(R) | # 3348065 | Mercedes Benz |
| # 3358017 | Land Rover | | B-Class (W246, W242) [11.11 - 12.18] - F(L) |
| | Range Rover Evoque (L538) [6.11 - 12.19] - F(L) | # 3348064 | Mercedes Benz |
| # 3358016 | Land Rover | | B-Class (W246, W242) [11.11 - 12.18] - F(R) |
| | Range Rover Evoque (L538) [6.11 - 12.19] - F(R) | # 5538001 | Mercedes Benz |
| # 3358019 | Land Rover | | B-Class (W246, W242) [11.11 - 12.18] - R |
| | Range Rover Evoque (L538) [6.11 - 12.19] - R(L) | # 5538002 | Mercedes Benz |
| | | | B-Class (W246, W242) [11.11 - 12.18] - R |

NEW ADDITIONS

New Part No/Neue Teile No/ Nouveau No.

◇ : in preparation/in Vorbereitung/en études

| KYB | VEHICLE FAHRZEUG VEHICULE | KYB | VEHICLE FAHRZEUG VEHICULE |
|-------------|--|-------------|---|
| # 3348061 | Mercedes Benz CLA-Class (C117) [1.13 - 3.19] - F(L) | # 3410059 | Mitsubishi Eclipse Cross (GK_) [10.17-] - R |
| # 3348060 | Mercedes Benz CLA-Class (C117) [1.13 - 3.19] - F(R) | # 3320014 ◇ | Mitsubishi |
| # 3348063 | Mercedes Benz CLA-Class (C117) [1.13 - 3.19] - F(L) | | Mirage / Space Star VI (A0_A) [5.12 -] - F |
| # 3348062 | Mercedes Benz CLA-Class (C117) [1.13 - 3.19] - F(R) | # 348083 ◇ | Mitsubishi |
| # 3348065 | Mercedes Benz CLA-Class (C117) [1.13 - 3.19] - F(L) | | Mirage / Space Star VI (A0_A) [5.12 -] - R |
| # 3348064 | Mercedes Benz CLA-Class (C117) [1.13 - 3.19] - F(R) | # 3340046 | Mitsubishi |
| # 5538001 | Mercedes Benz CLA-Class (C117) [1.13 - 3.19] - R | | Outlander III (GF_W, GG_W) [8.12-] - F(L) |
| # 5538002 | Mercedes Benz CLA-Class (C117) [1.13 - 3.19] - R | # 3340045 | Mitsubishi |
| # 3348061 | Mercedes Benz | | Outlander III (GF_W, GG_W) [8.12-] - F(R) |
| | CLA-Class Shooting Brake (X117) [1.15 - 3.19] - F(L) | # 3340212 | Mitsubishi Outlander III (GG2W) [12.12 - 6.15] - F(L) |
| # 3348060 | Mercedes Benz | # 3340211 | Mitsubishi Outlander III (GG2W) [12.12 - 6.15] - F(R) |
| | CLA-Class Shooting Brake (X117) [1.15 - 3.19] - F(R) | # 3350037 | Mitsubishi |
| # 3348063 | Mercedes Benz | | Outlander III (GF_W, GG_W) [12.13-] - F(L) |
| | CLA-Class Shooting Brake (X117) [1.15 - 3.19] - F(L) | # 3350036 | Mitsubishi |
| # 3348062 | Mercedes Benz | | Outlander III (GF_W, GG_W) [12.13-] - F(R) |
| | CLA-Class Shooting Brake (X117) [1.15 - 3.19] - F(R) | # 3410059 | Mitsubishi Outlander III (GF_W, GG_W) [3.15-] - R |
| # 3348065 | Mercedes Benz | # 3410078 | Mitsubishi Outlander III (GG2W) [12.12 - 6.15] - R |
| | CLA-Class Shooting Brake (X117) [1.15 - 3.19] - F(L) | 339407 | Nissan Leaf (ZE1) [8.17 -] - F(L) |
| # 3348064 | Mercedes Benz | 339406 | Nissan Leaf (ZE1) [8.17 -] - F(R) |
| | CLA-Class Shooting Brake (X117) [1.15 - 3.19] - F(R) | # 3338048 | Nissan Micra V (K14) [12.16 -] - F(L) |
| # 5538001 | Mercedes Benz | # 3338047 | Nissan Micra V (K14) [12.16 -] - F(R) |
| | CLA-Class Shooting Brake (X117) [1.15 - 3.19] - R | # 5528000 | Nissan Micra V (K14) [12.16 -] - R |
| # 5538002 | Mercedes Benz | # 339189 | Nissan Murano II (Z51) [11.07 - 9.14] - F(L) |
| | CLA-Class Shooting Brake (X117) [1.15 - 3.19] - R | # 339188 | Nissan Murano II (Z51) [11.07 - 9.14] - F(R) |
| # 5530005 | Mercedes Benz CLS-Class (C257) [12.17 -] - R | # 339312 | Nissan Murano II (Z51) [1.10 - 9.14] - F(L) |
| # 5530005 | Mercedes Benz E-Class (W213) [1.16 -] - R | # 339311 | Nissan Murano II (Z51) [1.10 - 9.14] - F(R) |
| 553384 | Mercedes Benz E-Class (W213) [1.16 -] - R | # 349092 | Nissan Murano II (Z51) [11.07 - 9.14] - R |
| 553381 | Mercedes Benz E-Class (C238) [12.16 -] - R | # 3430043 | Nissan Note (E12) [6.13 -] - R |
| 553384 | Mercedes Benz E-Class (C238) [12.16 -] - R | # 3330055 | Nissan NV200, NV200 Evalia [2.10 -] - F(L) |
| 553381 | Mercedes Benz E-Class (A238) [6.17 -] - R | # 3330054 | Nissan NV200, NV200 Evalia [2.10 -] - F(R) |
| 553384 | Mercedes Benz E-Class (A238) [10.17 -] - R | 335803 | Nissan NV300 (X82) [9.16 -] - F |
| # 3348065 | Mercedes Benz GLA-Class (X156) [12.13 -] - F(L) | 344803 | Nissan NV300 (X82) [9.16 -] - R |
| # 3348064 | Mercedes Benz GLA-Class (X156) [12.13 -] - F(R) | # 3340173 | Nissan Qashqai II (J11, J11_) [11.13 -] - F(L) |
| # 5530009 | Mercedes Benz SLC (R172) [1.16 -] - R | # 3340172 | Nissan Qashqai II (J11, J11_) [11.13 -] - F(R) |
| # 5530009 | Mercedes Benz SLK (R172) [2.11 -] - R | # 3448029 | Nissan Qashqai II (J11, J11_) [11.13 -] - R |
| 331701 | Mercedes Benz Sprinter III (B907, B910) [2.18 -] - F | # 5540008 | Nissan Qashqai II (J11, J11_) [11.13 -] - R |
| 331702 | Mercedes Benz Sprinter III (B907, B910) [2.18 -] - F | 3348024 | Nissan Sentra (B17R) [8.14 -] - F(L) |
| # 3358026 | Mercedes Benz Viano (W639) [9.10 -] - F | 3348023 | Nissan Sentra (B17R) [8.14 -] - F(R) |
| # 3358026 | Mercedes Benz Vito (W639) [9.10 -] - F | # 3448026 | Nissan Sentra (B17R) [8.14 -] - R |
| # 3348101 ◇ | Mini Countryman (F60) [1.17 -] - F(L) | # 3340034 | Nissan X-Trail (T31) [2.12 - 11.13] - F(L) |
| # 3348100 ◇ | Mini Countryman (F60) [1.17 -] - F(R) | # 3340033 | Nissan X-Trail (T31) [2.12 - 11.13] - F(R) |
| # 3448034 | Mini Countryman (F60) [10.16 -] - R | # 349097 | Nissan X-Trail (T31) [7.10 - 11.13] - R |
| # 3350037 | Mitsubishi Eclipse Cross (GK_) [10.17-] - F(L) | # 5540008 | Nissan X-Trail (T31) [3.07 - 11.13] - R |
| # 3350036 | Mitsubishi Eclipse Cross (GK_) [10.17-] - F(R) | # 3340159 | Nissan X-Trail (T32_) [12.13 -] - F(L) |

NEW ADDITIONS

New Part No/Neue Teile No/ Nouveau No.

◇ : in preparation/in Vorbereitung/en études

| KYB | VEHICLE FAHRZEUG VEHICULE | KYB | VEHICLE FAHRZEUG VEHICULE |
|-------------|--|-------------|---|
| # 3340158 | Nissan X-Trail (T32_) [12.13 -] - F(R) | # 3340161 | Opel Zafira Tourer C (P12) [1.13 -] - F(L) |
| # 349097 | Nissan X-Trail (T32_) [12.13 -] - R | # 3340160 | Opel Zafira Tourer C (P12) [1.13 -] - F(R) |
| # 3430061 | Opel Adam, Adam Rocks (M13) [10.12 - 2.19] - R | # 3338054 | Peugeot 208 I (CA_, CC_) [3.12 -] - F(L) |
| # 3350067 ◇ | Opel Antara A (L07) [7.06 -] - F(L) | # 3338053 | Peugeot 208 I (CA_, CC_) [3.12 -] - F(R) |
| # 3350066 ◇ | Opel Antara A (L07) [7.06 -] - F(R) | # 3348036 | Peugeot 308 II, 308 II SW [9.13 -] - F |
| # 3440091 | Opel Astra K (B16) [6.15 -] - R | # 3338056 | Peugeot 2008 I (CU_) [3.13 -] - F(L) |
| # 3348081 | Opel Corsa E (X15) [3.15 -] - F(L) | # 3338055 | Peugeot 2008 I (CU_) [3.13 -] - F(R) |
| # 3348080 | Opel Corsa E (X15) [3.15 -] - F(R) | # 3348091 | Peugeot 3008 (M_) [5.16 -] - R |
| # 3430078 | Opel Corsa E (X15) [9.14 -] - R | 3448001 | Peugeot 3008 (M_) [5.16 -] - R |
| # 3338052 | Opel | # 3348091 | Peugeot 5008 II [12.16 -] - F |
| | Crossland X / Crossland (P17, P2Q0) [3.17 -] - F(L) | 3448001 | Peugeot 5008 II [12.16 -] - R |
| # 3338051 | Opel | # 3348084 | Peugeot Expert / Traveller (V_) [4.16 -] - F |
| | Crossland X / Crossland (P17, P2Q0) [3.17 -] - F(R) | # 3348085 | Peugeot Expert / Traveller (V_) [4.16 -] - F |
| 3438001 | Opel | # 3458001 | Peugeot Expert / Traveller (V_) [4.16 -] - R |
| | Crossland X / Crossland (P17, P2Q0) [3.17 -] - R | # 3418008 ◇ | Peugeot Partner (K9) [9.18 -] - R |
| # 3348091 | Opel Grandland X (A18) [6.17 -] - F | 338737 | Renault Captur (H5_) [3.16 -] - F |
| 3448001 | Opel Grandland X (A18) [6.17 -] - R | 338738 | Renault Captur (H5_) [3.16 -] - R |
| 243014 | Opel Insignia A [7.08 - 3.17] - R | # 3338037 | Renault Clio IV (BH_) [11.12 -] - F |
| 343047 | Opel Insignia A [7.08 - 3.17] - R | # 3338036 | Renault Clio IV Grandtour (KH_) [1.13 -] - F |
| 443134 | Opel Insignia A [7.08 - 3.17] - R | # 3338037 | Renault Clio IV Grandtour (KH_) [1.13 -] - F |
| 553075 | Opel Insignia A [7.08 - 3.17] - R | # 3338034 | Renault Dokker, Dokker Express [12.13 -] - F |
| 243014 | Opel Insignia A Sports Tourer [7.08 - 3.17] - R | 338737 | Renault Duster (HM) [7.19 -] - F |
| 343047 | Opel Insignia A Sports Tourer [7.08 - 3.17] - R | 338738 | Renault Duster (HM) [7.19 -] - R |
| 443134 | Opel Insignia A Sports Tourer [7.08 - 3.17] - R | 343827 | Renault Duster (HM) [7.19 -] - R |
| 553075 | Opel Insignia A Sports Tourer [7.08 - 3.17] - R | # 3348075 | Renault Espace V (JR_) [2.15 -] - F |
| 243014 | Opel Insignia A Country Tourer [9.13 - 3.17] - R | 344707 | Renault Espace V (JR_) [2.15 -] - R |
| 343047 | Opel Insignia A Country Tourer [9.13 - 3.17] - R | # 3340173 | Renault Kadjar (HA_, HL_) [6.15 -] - F(L) |
| 443134 | Opel Insignia A Country Tourer [9.13 - 3.17] - R | # 3340172 | Renault Kadjar (HA_, HL_) [6.15 -] - F(R) |
| 553075 | Opel Insignia A Country Tourer [9.13 - 3.17] - R | # 3448029 | Renault Kadjar (HA_, HL_) [6.15 -] - R |
| # 3440073 | Opel Insignia B Grand Sport (Z18) [3.17 -] - R | 349078 | Renault Kadjar (HA_, HL_) [6.15 -] - R |
| # 3440073 | Opel Insignia B Country Tourer (Z18) [3.17 -] - R | # 5540008 | Renault Koleos [9.08 -] - R |
| # 3440073 | Opel Insignia B Sports Tourer (Z18) [3.17 -] - R | # 349238 | Renault Latitude (L70_) [7.10 -] - R |
| # 3430069 | Opel Karl (C16) [1.15 - 3.19] - R | # 3338023 | Renault Lodgy [7.13 -] - F |
| # 3340214 | Opel Mokka / Mokka X (J13) [6.12 -] - F(L) | # 3338034 | Renault Lodgy [7.13 -] - F |
| # 3340213 | Opel Mokka / Mokka X (J13) [6.12 -] - F(R) | 3448005 | Renault Lodgy [7.13 -] - R |
| # 3348050 | Opel Signum [4.02 - 5.08] - F(L) | # 338112 | Renault Logan (LS) [9.04 -] - F |
| # 3348049 | Opel Signum [4.02 - 5.08] - F(R) | # 3348087 | Renault Mégane IV, |
| # 3348050 | Opel Vectra C [4.02 -] - F(L) | | Mégane IV Grandtour (B9A/M_, K9A/M_) [11.15 -] - F |
| # 3348049 | Opel Vectra C [4.02 -] - F(R) | # 3348092 | Renault Mégane IV, |
| 335803 | Opel Vivaro (X82) [6.14 -] - F | | Mégane IV Grandtour (B9A/M_, K9A/M_) [11.15 -] - F |
| 344803 | Opel Vivaro (X82) [6.14 -] - R | # 3448031 | Renault Mégane IV, |
| # 3348084 | Opel Vivaro C / Zafira Life (K0) [3.19 -] - F | | Mégane IV Grandtour (B9A/M_, K9A/M_) [11.15 -] - R |
| # 3348085 | Opel Vivaro C / Zafira Life (K0) [3.19 -] - F | # 3348087 | Renault Mégane IV [10.16 -] - F |
| # 3458001 | Opel Vivaro C / Zafira Life (K0) [3.19 -] - R | # 3348092 | Renault Mégane IV [10.16 -] - F |

NEW ADDITIONS

New Part No/Neue Teile No/ Nouveau No.

◇ : in preparation/in Vorbereitung/en études

| KYB | VEHICLE FAHRZEUG VEHICULE | KYB | VEHICLE FAHRZEUG VEHICULE |
|-------------|---|-------------|--|
| 344707 | Renault Mégane IV [10.16 -] - R | # 3348039 | Seat Leon (5F1), Leon SC (5F5), Leon ST (5F8) [9.12 -] - F |
| # 3338042 | Renault Sandero II (B8_) [9.16 -] - F | # 3358015 | Seat Leon (5F1), Leon SC (5F5), Leon ST (5F8) [9.12 -] - F |
| # 343834 | Renault Sandero II (B8_) [9.16 -] - R | # 3448024 | Seat Leon (5F1), Leon SC (5F5), Leon ST (5F8) [9.12 -] - R |
| 343836 | Renault Sandero II (B8_) [12.13 -] - R | # 3448025 | Seat Leon (5F1), Leon SC (5F5), Leon ST (5F8) [9.12 -] - R |
| # 3338042 | Renault Sandero Stepway II (B8_) [11.13 -] - F | # 3338038 | Seat Mii (KF1) [10.11 -] - F |
| 338749 | Renault Sandero Stepway II (B8_) [11.13 -] - F | # 3358020 | Seat Tarraco (KN2) [9.18 -] - F |
| 338759 | Renault Sandero Stepway II (B8_) [11.13 -] - F | # 3448024 | Seat Tarraco (KN2) [9.18 -] - R |
| 343833 | Renault Sandero Stepway II (B8_) [11.13 -] - R | # 633276 | Seat Toledo I (1L) [91 - 99] - F |
| # 343834 | Renault Sandero Stepway II (B8_) [11.13 -] - R | # 3338038 | Skoda Citigo [10.11 -] - F |
| # 3348087 | Renault Scénic IV, Grand Scénic IV (J9_, R9_) [9.16 -] - F | 339763 | Skoda Fabia III (NJ3, NJ5) [8.14 -] - F |
| 344707 | Renault Scénic IV, Grand Scénic IV (J9_, R9_) [9.16 -] - R | 343328 | Skoda Fabia III (NJ3, NJ5) [8.14 -] - R |
| # 3348086 | Renault Talisman, Talisman Grandtour (LP_, KP_) [11.15 -] - F | 343348 | Skoda Fabia III (NJ3, NJ5) [8.14 -] - R |
| # 3448030 | Renault Talisman, Talisman Grandtour (LP_, KP_) [11.15 -] - R | 343824 | Skoda Fabia III (NJ3, NJ5) [8.14 -] - R |
| 633707 | Renault Thalia, Symbol (LB0/1/2) [4.02 -] - F | 353025 | Skoda Fabia III (NJ3, NJ5) [8.14 -] - R |
| # 6338001 | Renault Thalia, Symbol (LB0/1/2) [8.00 -] - F | 552700 | Skoda Fabia III (NJ3, NJ5) [8.14 -] - R |
| 333707 | Renault Thalia II, Symbol II (LU1/2_) [9.08 -] - F | # 3348074 | Skoda Kamiq (NW4) [7.19 -] - F |
| 333743 | Renault Thalia II, Symbol II (LU1/2_) [9.08 -] - F | # 3348090 | Skoda Kamiq (NW4) [7.19 -] - F |
| 633707 | Renault Thalia II, Symbol II (LU1/2_) [9.08 -] - F | # 3430074 | Skoda Kamiq (NW4) [7.19 -] - R |
| # 6338001 | Renault Thalia II, Symbol II (LU1/2_) [9.08 -] - F | # 3430079 ◇ | Skoda Kamiq (NW4) [7.19 -] - R |
| 343289 | Renault Thalia II, Symbol II (LU1/2_) [9.08 -] - R | # 3448023 | Skoda Karoq (NU7) [7.17 -] - R |
| 443398 | Renault Thalia II, Symbol II (LU1/2_) [9.08 -] - R | # 3448027 | Skoda Karoq (NU7) [7.17 -] - R |
| 338749 | Renault Thalia III, Symbol III (L8_) [12.13 -] - F | # 3358020 | Skoda Kodiaq (NS7, NV7) [10.16 -] - F |
| 338759 | Renault Thalia III, Symbol III (L8_) [12.13 -] - F | # 3348039 | Skoda Octavia III (5E3) [11.12 -] - F |
| 343833 | Renault Thalia III, Symbol III (L8_) [12.13 -] - R | # 3358015 | Skoda Octavia III (5E3) [11.12 -] - F |
| 335803 | Renault Trafic III (JG_, FG_, EG_) [5.14 -] - F | # 3448024 | Skoda Octavia III (5E3) [11.12 -] - R |
| 344803 | Renault Trafic III (JG_, FG_, EG_) [5.14 -] - R | # 3448025 | Skoda Octavia III (5E3) [11.12 -] - R |
| # 3438008 ◇ | Renault Twingo III (BCM) [11.16 -] - R | # 3348039 | Skoda Octavia III Combi (5E5) [11.12 -] - F |
| # 3348090 | Seat Arona (KJ7) [7.17 -] - F | # 3358015 | Skoda Octavia III Combi (5E5) [11.12 -] - F |
| # 3430074 | Seat Arona (KJ7) [7.19 -] - R | # 3448024 | Skoda Octavia III Combi (5E5) [11.12 -] - R |
| # 3430079 ◇ | Seat Arona (KJ7) [7.17 - 6.19] - R | # 3448025 | Skoda Octavia III Combi (5E5) [11.12 -] - R |
| # 633276 | Seat Arosa (6H) [97 - 6.04] - F | 339763 | Skoda Rapid, Rapid Spaceback (NH_, NK_) [7.12 -] - F |
| # 3448023 | Seat Ateca (KH7) [4.16 -] - R | # 3348074 | Skoda Scala (NW1) [2.19 -] - F |
| # 3448027 | Seat Ateca (KH7) [4.16 -] - R | # 3348090 | Skoda Scala (NW1) [2.19 -] - F |
| # 633276 | Seat Cordoba Vario (6K) [97 - 8.02] - F | # 3430074 | Skoda Scala (NW1) [2.19 -] - R |
| # 633276 | Seat Ibiza, Cordoba (6K, 6K/C) [93 - 2.02] - F | # 3430079 ◇ | Skoda Scala (NW1) [2.19 -] - R |
| # 3348020 | Seat Ibiza IV (6J_, 6P_) [10.08 - 6.17] - F | # 3358015 | Skoda Superb III (3V3, 3V5) [3.15 -] - F |
| # 3348074 | Seat Ibiza V (KJ1) [1.17 -] - F | # 3448024 | Skoda Superb III (3V3, 3V5) [3.15 -] - R |
| # 3430074 | Seat Ibiza V (KJ1) [1.17 -] - R | # 3338044 | Smart Forfour I (454) [1.04 - 6.06] - F(L) |
| # 3430079 ◇ | Seat Ibiza V (KJ1) [1.17 -] - R | # 3338043 | Smart Forfour I (454) [1.04 - 6.06] - F(R) |
| # 633276 | Seat Inca (6K) [96 - 6.03] - F | | |

NEW ADDITIONS

New Part No./Neue Teile No/ Nouveau No.

◇ : in preparation/in Vorbereitung/en études

| KYB | VEHICLE FAHRZEUG VEHICULE | KYB | VEHICLE FAHRZEUG VEHICULE |
|------------|---|------------|--|
| #3438008 ◇ | Smart Forfour II (453) [7.16 -] - R | #3440083 | Toyota RAV 4 V (_A5_,_H5_) [12.18 -] - R |
| #3438008 ◇ | Smart Fortwo Coupé, Fortwo Cabrio III (453) [7.16 -] - R | #3430061 | Vauxhall Adam, Adam Rocks (M13) [10.12 - 4.19] - R |
| 341612 | SsangYong Actyon I [11.05 -] - F | #3350067 ◇ | Vauxhall Antara A (L07) [8.06 -] - F(L) |
| 341612 | SsangYong Actyon Sport I (QJ) [4.07 -] - F | #3350066 ◇ | Vauxhall Antara A (L07) [8.06 -] - F(R) |
| 341612 | SsangYong Kyron [5.05 -] - F | #3440091 | Vauxhall Astra K (B16) [7.15 -] - R |
| 341612 | SsangYong Rexton (12-) [7.12 - 3.14] - F | #3348081 | Vauxhall Corsa Mk IV (E) (X15) [4.15 -] - F(L) |
| 339413 | Subaru Impreza (GP_) [1.12 -] - F(L) | #3348080 | Vauxhall Corsa Mk IV (E) (X15) [4.15 -] - F(R) |
| 339412 | Subaru Impreza (GP_) [1.12 -] - F(R) | #3430078 | Vauxhall Corsa Mk IV (E) (X15) [8.14 -] - R |
| #3320023 ◇ | Suzuki Celerio (LF) [3.14 -] - F(L) | #3338052 | Vauxhall Crossland X (P17) [3.17 -] - F(L) |
| #3320022 ◇ | Suzuki Celerio (LF) [3.14 -] - F(R) | #3338051 | Vauxhall Crossland X (P17) [3.17 -] - F(R) |
| #3430032 ◇ | Suzuki Celerio (LF) [3.14 -] - R | 3438001 | Vauxhall Crossland X (P17) [3.17 -] - R |
| #3330128 | Suzuki Swift V (AZ) [4.17 -] - F(L) | #3348091 | Vauxhall Grandland X (A18) [6.17 -] - F |
| #3330127 | Suzuki Swift V (AZ) [4.17 -] - F(R) | 3448001 | Vauxhall Grandland X (A18) [6.17 -] - R |
| #3358012 | Toyota Auris (E18) [3.15 -] - F(L) | #3440073 | Vauxhall Insignia Mk II (Z18) [3.17 -] - R |
| #3358011 | Toyota Auris (E18) [3.15 -] - F(R) | #3440073 | Vauxhall Insignia Mk II Country Tourer (Z18) [3.17 -] - R |
| #3358012 | Toyota Auris Touring Sports (E18) [3.15 -] - F(L) | #3440073 | Vauxhall Insignia Mk II Sports Tourer (Z18) [3.17 -] - R |
| #3358011 | Toyota Auris Touring Sports (E18) [3.15 -] - F(R) | #3340214 | Vauxhall Mokka / Mokka X (J13) [6.12 -] - F(L) |
| 3448008 | Toyota Auris Touring Sports (E18) [7.13 -] - R | #3340213 | Vauxhall Mokka / Mokka X (J13) [6.12 -] - F(R) |
| #3448019 | Toyota Avensis (_T27_) [11.08 -] - R | #3348050 | Vauxhall Signum [4.02 - 5.08] - F(L) |
| #341396 | Toyota Hilux VIII (_N1_) [5.15 -] - F | #3348049 | Vauxhall Signum [4.02 - 5.08] - F(R) |
| #3440051 ◇ | Toyota Hilux VIII (_N1_) [5.15 -] - R | #3348050 | Vauxhall Vectra C [4.02 - 10.08] - F(L) |
| #340085 | Toyota Land Cruiser (_J15_) [8.09 -] - F | #3348049 | Vauxhall Vectra C [4.02 - 10.08] - F(R) |
| #5510017 | Toyota Land Cruiser (_J15_) [8.09 -] - F | #3430069 | Vauxhall Viva (C16) [1.15 - 3.18] - R |
| #3450000 | Toyota Land Cruiser (_J15_) [8.09 -] - R | 335803 | Vauxhall Vivaro (X82) [5.14 -] - F |
| #5540001 | Toyota Land Cruiser (_J15_) [8.09 -] - R | 344803 | Vauxhall Vivaro (X82) [5.14 -] - R |
| #340085 | Toyota Land Cruiser Prado (_J15_) [8.09 -] - F | #3348084 | Vauxhall Vivaro C / Vivaro Life (K0) [3.19 -] - F |
| #5510017 | Toyota Land Cruiser Prado (_J15_) [8.09 -] - F | #3348085 | Vauxhall Vivaro C / Vivaro Life (K0) [3.19 -] - F |
| #3450000 | Toyota Land Cruiser Prado (_J15_) [8.09 -] - R | #3458001 | Vauxhall Vivaro C / Vivaro Life (K0) [3.19 -] - R |
| #5540001 | Toyota Land Cruiser Prado (_J15_) [8.09 -] - R | #3340161 | Vauxhall Zafira Tourer Mk III (P12) [1.13 -] - F(L) |
| #3350027 | Toyota Prius (_W5_) [9.15 -] - F(L) | #3340160 | Vauxhall Zafira Tourer Mk III (P12) [1.13 -] - F(R) |
| #3350026 | Toyota Prius (_W5_) [9.15 -] - F(R) | #3358015 | Volkswagen Arteon, Arteon Shooting Brake (3H_) [3.17 -] - F |
| #3440083 | Toyota Prius (_W5_) [9.15 -] - R | #3448024 | Volkswagen Arteon, Arteon Shooting Brake (3H_) [3.17 -] - R |
| #3440083 | Toyota Prius PHV (_W52_) [1.16 -] - R | 335808 | Volkswagen Caddy IV (SAB, SAJ, SAA, SAH) [5.15 - 9.20] - F |
| #3348084 | Toyota Proace (MDZ_) [2.16 -] - F | 344458 | Volkswagen Caddy IV (SAB, SAJ, SAA, SAH) [5.15 - 9.20] - R |
| #3348085 | Toyota Proace (MDZ_) [2.16 -] - F | 349201 | Volkswagen Caddy IV (SAB, SAJ, SAA, SAH) [5.15 - 9.20] - R |
| #3458001 | Toyota Proace (MDZ_) [2.16 -] - R | | |
| #3348084 | Toyota Proace Verso (MDY_) [7.18 -] - F | | |
| #3348085 | Toyota Proace Verso (MDY_) [7.18 -] - F | | |
| #3458001 | Toyota Proace Verso (MDY_) [7.18 -] - R | | |
| #3350039 | Toyota RAV 4 IV (_A4_) [10.15 - 12.18] - F(L) | | |
| #3350038 | Toyota RAV 4 IV (_A4_) [10.15 - 12.18] - F(R) | | |
| #339335 | Toyota RAV 4 IV (_A4_) [12.12 - 12.18] - F(L) | | |
| #339334 | Toyota RAV 4 IV (_A4_) [12.12 - 12.18] - F(R) | | |

NEW ADDITIONS

New Part No/Neue Teile No/ Nouveau No.

◇ : in preparation/in Vorbereitung/en études

| KYB | VEHICLE FAHRZEUG VEHICULE | KYB | VEHICLE FAHRZEUG VEHICULE |
|------------|--|-------------|---|
| 335808 | Volkswagen | # 633276 | Volkswagen Polo Caddy (9K) [96 -] - F |
| | Caddy Maxi IV (SAB, SAJ, SAA, SAH) [5.15 - 9.20] - F | # 3348090 | Volkswagen T-Cross (C11) [12.18 -] - F |
| 344458 | Volkswagen | # 3430074 | Volkswagen T-Cross (C11) [12.18 -] - R |
| | Caddy Maxi IV (SAB, SAJ, SAA, SAH) [5.15 - 9.20] - R | # 3358020 | Volkswagen Tiguan (AD1, AX1) [1.16 -] - F |
| 349227 | Volkswagen | # 3448024 | Volkswagen Tiguan (AD1, AX1) [1.16 -] - R |
| | Caddy Maxi IV (SAB, SAJ, SAA, SAH) [5.15 - 9.20] - R | # 3358020 | Volkswagen Tiguan Allspace (BW2, BJ2) [4.17 -] - F |
| 335808 | Volkswagen Caddy Alltrack (SAB, SAA) [5.15 -] - F | # 3448024 | Volkswagen Tiguan Allspace (BW2, BJ2) [4.17 -] - R |
| 344458 | Volkswagen Caddy Alltrack (SAB, SAA) [5.15 -] - R | # 3358015 | Volkswagen Touran (5T1) [5.15 -] - F |
| # 633276 | Volkswagen Golf II, Jetta II [8.83 - 92] - F | # 3448024 | Volkswagen Touran (5T1) [5.15 -] - R |
| # 633276 | Volkswagen Golf III, Vento, Jetta III (1H) [9.91 - 98] - F | 335839 | Volkswagen Transporter VI, California VI, Caravelle VI, Multivan VI (S_) [4.15 -] - F |
| # 633276 | Volkswagen Golf III Variant (1H) [9.93 - 98] - F | 335840 | Volkswagen Transporter VI, California VI, Caravelle VI, Multivan VI (S_) [4.15 -] - F |
| # 3348039 | Volkswagen Golf VII (5G1, BQ1, BE1, BE2) [8.12 -] - F | 344456 | Volkswagen Transporter VI, California VI, Caravelle VI, Multivan VI (S_) [4.15 -] - R |
| # 3358015 | Volkswagen Golf VII (5G1, BQ1, BE1, BE2) [8.12 -] - F | # 3358015 | Volkswagen T-Roc (A11) [7.17 -] - F |
| # 3448024 | Volkswagen Golf VII (5G1, BQ1, BE1, BE2) [8.12 -] - R | # 3448023 | Volkswagen T-Roc (A11) [7.17 -] - R |
| # 3448025 | Volkswagen Golf VII (5G1, BQ1, BE1, BE2) [8.12 -] - R | # 3448027 | Volkswagen T-Roc (A11) [7.17 -] - R |
| # 3348039 | Volkswagen Golf VII Variant (BA5, BV5) [4.13 -] - F | # 3358015 | Volkswagen T-Roc (AC7) [12.19 -] - F |
| # 3358015 | Volkswagen Golf VII Variant (BA5, BV5) [4.13 -] - F | # 3448023 | Volkswagen T-Roc (AC7) [12.19 -] - R |
| 3430023 | Volkswagen Golf VII Variant (BA5, BV5) [4.13 -] - R | # 3338038 | Volkswagen Up, Load Up (12_, BL_) [8.11 -] - F |
| # 3448024 | Volkswagen Golf VII Variant (BA5, BV5) [4.13 -] - R | # 3338041 | Volkswagen Up, Load Up (12_, BL_) [8.11 -] - F |
| # 3448025 | Volkswagen Golf VII Variant (BA5, BV5) [4.13 -] - R | # 3358014 | Volvo S60 II (134) [4.10 -] - F(L) |
| # 3348039 | Volkswagen Golf Sportsvan (AM1, AN1) [2.14 -] - F | # 3358013 | Volvo S60 II (134) [4.10 -] - F(R) |
| # 3448024 | Volkswagen Golf Sportsvan (AM1, AN1) [2.14 -] - R | 349194 | Volvo V40 (525, 526) [3.12 -] - R |
| # 3448025 | Volkswagen Golf Sportsvan (AM1, AN1) [2.14 -] - R | 553389 | Volvo V40 Cross Country (525, 526) [3.12 -] - R |
| # 633276 | Volkswagen Lupo (6X) [98 - 7.05] - F | # 553390 | Volvo V40 Cross Country (525, 526) [3.12 -] - R |
| # 3358015 | Volkswagen Passat (3G2, CB2), Passat Variant (3G5, CB5) [8.14 -] - F | # 3358014 | Volvo V60 (155, 157) [9.10 -] - F(L) |
| # 3448023 | Volkswagen Passat (3G2, CB2), Passat Variant (3G5, CB5) [8.14 -] - R | # 3358013 | Volvo V60 (155, 157) [9.10 -] - F(R) |
| # 3448024 | Volkswagen Passat (3G2, CB2), Passat Variant (3G5, CB5) [8.14 -] - R | # 3348083 ◇ | Volvo XC60 I (156) [5.08 - 12.17] - F(L) |
| # 3358015 | Volkswagen Passat Alltrack (3G5, CB5) [5.15 -] - F | # 3348082 ◇ | Volvo XC60 I (156) [5.08 - 12.17] - F(R) |
| # 3448023 | Volkswagen Passat Alltrack (3G5, CB5) [5.15 -] - R | # 553382 | Volvo XC90 I (275) [6.02 - 1.15] - R |
| # 3448024 | Volkswagen Passat Alltrack (3G5, CB5) [5.15 -] - R | | |
| # 633276 | Volkswagen | | |
| | Polo, Derby (6N1, 6N2, 6KV2) [9.94 - 9.01] - F | | |
| # 633276 | Volkswagen Polo, Polo Variant (6KV5, 6NF) [97 - 9.01] - F | | |
| # 3348020 | Volkswagen Polo V (6R1, 6C1) [5.10 -] - F | | |
| 339763 | Volkswagen Polo V (602, 604, 612, 614) [5.10 -] - F | | |
| 339741 | Volkswagen Polo V (602, 604, 612, 614) [5.10 -] - F | | |
| 344357 | Volkswagen Polo V (602, 604, 612, 614) [5.10 -] - R | | |
| # 3348074 | Volkswagen Polo VI (AW1, BZ1) [6.17 -] - F | | |
| # 3430074 | Volkswagen Polo VI (AW1, BZ1) [6.17 -] - R | | |

NEW ADDITIONS

New Part No/Neue Teile No/ Nouveau No.

◇ : in preparation/in Vorbereitung/en études

| | VEHICLE FAHRZEUG VEHICULE | | VEHICLE FAHRZEUG VEHICULE |
|---|---|---|---|
| <h2>SUSPENSION MOUNTING KIT</h2> | | # SM9942 # SM9943 # SM9943 # SM9943 | Ford Focus (DAW, DBW, DFW) [10.98 - 11.04] - R Hyundai Getz (TB) [8.02 - 6.09] - R Hyundai i10 II (BA, IA) [8.13 -] - R Hyundai Grand i10 [08.15 -] - R |
| SM1714 SM9708 SM9926 SM9926 SM9926 SM9926 SM9926 SM9926 SM1008 #SM5601 #SM1061 SM1055 SM1055 SM1930 SM9901 #SM1061 SM1055 SM9901 #SM1062 #SM1063 MB1504 SM1528 MB1901 SM1553 MB1901 SM1933 SM9902 MB1901 #SM1062 #SM1063 SM1810 SM9806 SM9805 #SM5892 #SM5891 SM1822 SM1821 SM1822 SM1821 SM1811 SM9806 SM9805 | Audi Q3 (8U) [6.11 -] - F Audi S3 (8P1, 8PA) [6.08 - 3.13] - R BMW 3 Series Gran Turismo (F34) [11.12 -] - R BMW 4 Series (F32) [7.13 -] - R BMW 4 Series (F33) [10.13 -] - R BMW 4 Series Gran Coupe (F36) [3.14 -] - R BMW X2 (F39) [11.17 -] - R Chevrolet Orlando (J309) [2.11 -] - F Chrysler - Dodge - Plymouth Caliber [6.06 -] - F Citroën Berlingo (B9) [2.08 -] - F Citroën Berlingo (ER_, EC_) [6.18 -] - F Citroën Berlingo (K9) [6.18 -] - F Citroën C1 II [4.14 -] - F Citroën C4 II (B7) [11.09 -] - R Citroën C4 Picasso I, C4 Grand Picasso I [9.06 -] - F Citroën C4 Spacetourer (3D_) [4.18 -] - F Citroën DS4 [4.11 - 7.15] - R Citroën DS5 [11.11 - 7.15] - F Citroën DS5 [11.11 - 7.15] - F Dacia Sandero Stepway II [10.12 -] - F Dacia Sandero Stepway II [10.12 -] - F DS 3 (SA_, SB_) [4.15 - 7.19] - F DS 3 (SA_, SB_) [4.15 - 7.19] - F DS 4 [7.15 -] - F DS 4 [7.15 -] - F DS 4 [7.15 -] - F DS 4 [7.15 -] - R DS 5 [4.15 -] - F DS 5 [4.15 -] - F DS 5 [4.15 -] - F Fiat 500, 500 C (312) [10.07 -] - F Fiat 500 L (351_, 352_) [9.12 -] - R(L) Fiat 500 L (351_, 352_) [9.12 -] - R(R) Fiat 500X (334_) [9.14 -] - R(L) Fiat 500X (334_) [9.14 -] - R(R) Fiat Doblo (263) [11.09 -] - F(L) Fiat Doblo (263) [11.09 -] - F(R) Fiat Doblo Cargo (263) [2.10 -] - F(L) Fiat Doblo Cargo (263) [2.10 -] - F(R) Fiat Panda, Panda Classic (169) [9.03 -] - F Fiat Tipo (356) [10.15 -] - R(L) Fiat Tipo (356) [10.15 -] - R(R) | SM5669 SM5669 SM5669 SM5539 #SM5601 #SM5892 #SM5891 #SM5601 #SM5892 #SM5891 #SM9943 #SM9943 #SM5776 SM1811 SM1550 #SM5890 #SM5890 #SM1056 SM1548 SM1548 SM1548 SM1548 SM1548 SM1548 SM1548 SM1548 SM9926 SM9926 SM9926 SM1016 SM1017 #SM9930 #SM5888 #SM5887 SM9908 SM1313 #SM1076 #SM1076 SM5652 SM5651 SM5652 | Hyundai i30 II (GD) [11.11 -] - R Hyundai i30 CW II (GD) [6.12 -] - R Hyundai i30 Coupé [5.13 -] - R Hyundai ix55 / Veracruz [8.07 -] - F Jeep Compass (MK49), Patriot (MK74) [8.06 -] - F Jeep Compass (MP, MP6) [12.16 -] - R(L) Jeep Compass (MP, MP6) [12.16 -] - R(R) Jeep Liberty (KK) [1.08 -] - F Jeep Renegade (BU, B1) [7.14 -] - R(L) Jeep Renegade (BU, B1) [7.14 -] - R(R) Kia Picanto (SA) [4.04 -] - R Kia Picanto (TA) [5.11 -] - R Kia Sorento II (XM) [11.09 - 9.12] - F Lancia Ypsilon (843) [10.03 - 12.11] - F Mazda 2, Demio (DE) [10.07 -] - F Mazda CX-5 (KF) [5.17 -] - R Mazda CX-9 (TC) [6.16 -] - R Mercedes Benz A-Class (W168) [7.97 - 8.04] - F Mercedes Benz CLK (208) [6.97 - 02] - F Mercedes Benz CLK (208) [6.97 - 02] - R Mercedes Benz SLC (R172) [1.16 -] - F Mercedes Benz SLK (R170) [9.96 - 4.04] - F Mercedes Benz SLK (R170) [9.96 - 4.04] - R Mercedes Benz SLK (R171) [3.04 - 2.11] - R Mercedes Benz SLK (R172) [2.11 -] - F Mini Clubman (F54) [11.14 -] - R Mini Convertible (F57) [11.14 -] - R Mini Countryman (F60) [10.16 -] - R Nissan Leaf (ZE1) [8.17 -] - F(L) Nissan Leaf (ZE1) [8.17 -] - F(R) Opel Agila (H08) [9.07 -] - R Opel Astra K (B16) [6.15 -] - F Opel Astra K (B16) [6.15 -] - R Opel Cascada (W13) [3.13 -] - R Opel Corsa C [9.00 -] - F Opel Insignia A [7.08 - 3.17] - F Opel Insignia A Sports Tourer [7.08 - 3.17] - F Opel Insignia A Sports Tourer [7.08 - 3.17] - R(L) Opel Insignia A Sports Tourer [7.08 - 3.17] - R(R) Opel Insignia A Country Tourer [7.08 - 3.17] - R(L) |

NEW ADDITIONS

New Part No/Neue Teile No/ Nouveau No.

◇ : in preparation/in Vorbereitung/en études

| KYB | VEHICLE FAHRZEUG VEHICULE | KYB | VEHICLE FAHRZEUG VEHICULE |
|------------|--|------------|--|
| SM5651 | Opel Insignia A Country Tourer [7.08 - 3.17] - R(R) | # SM5887 | Vauxhall Astra K (B16) [7.15 -] - R |
| # SM1036 | Opel Meriva B (S10) [6.10 -] - F | SM9908 | Vauxhall Cascada (W13) [2.13 -] - R |
| SM1313 | Opel Tigra Twintop [7.04 -] - F | SM1313 | Vauxhall Corsa C [9.00 -] - F |
| SM1008 | Opel Zafira Tourer C (P12) [10.11 -] - F | # SM1076 | Vauxhall Insignia [7.08 -] - F |
| SM9908 | Opel Zafira Tourer C (P12) [10.11 -] - R | # SM1076 | Vauxhall Insignia Sports Tourer [7.08 - 5.17] - F |
| SM1930 | Peugeot 108 [5.14 -] - F | SM5652 | Vauxhall Insignia Sports Tourer [7.08 - 5.17] - R(L) |
| SM9901 | Peugeot 308 CC [4.09 -] - R | SM5651 | Vauxhall Insignia Sports Tourer [7.08 - 5.17] - R(R) |
| SM1055 | Peugeot 3008 (M_) [5.16 -] - F | SM5652 | Vauxhall |
| SM1055 | Peugeot 5008 II [12.16 -] - F | | Insignia Country Tourer [7.08 - 5.17] - R(L) |
| # SM1061 | Peugeot Partner Tepee/Ranch, Partner/Ranch (B9) [4.08 -] - F | SM5651 | Vauxhall |
| SM1055 | Peugeot Partner (18-) (K9) [9.18 -] - F | # SM1036 | Insignia Country Tourer [7.08 - 5.17] - R(R) |
| SM1055 | Peugeot Rifter [9.18 -] - F | SM1313 | Vauxhall Meriva Mk II (B) (S10) [6.10 -] - F |
| MB1504 | Renault Captur (H5_) [3.16 -] - F | SM1008 | Vauxhall Tigra Twintop [7.04 -] - F |
| SM1528 | Renault Captur (H5_) [3.16 -] - F | SM9908 | Vauxhall Zafira Tourer Mk III (P12) [10.11 -] - F |
| SM1528 | Renault Captur (H5_) [3.16 -] - R | SM1714 | Vauxhall Zafira Tourer Mk III (P12) [10.11 -] - R |
| MB1504 | Renault Lodgy [7.13 -] - F | SM1714 | Volkswagen Caddy IV (SA_) [5.15 - 9.20] - F |
| SM1528 | Renault Lodgy [7.13 -] - F | SM1714 | Volkswagen Caddy Maxi IV (SA_) [5.15 - 9.20] - F |
| MB1504 | Renault Sandero Stepway II (B8_) [11.13 -] - F | # SM9939 | Volkswagen Caddy Alltrack (SA_) [5.15 -] - F |
| SM1528 | Renault Sandero Stepway II (B8_) [11.13 -] - F | SM1708 | Volkswagen Lupo (6X, 6E) [98 -] - R |
| # SM9939 | Seat Arosa (6H) [97 - 6.04] - R | SM9704 | Volkswagen Polo V (602, 604, 612, 614) [5.10 -] - F |
| SM9924 | Seat Leon (5F1), Leon SC (5F5), Leon ST (5F8) [9.12 -] - R | SM1051 | Volkswagen Polo V (602, 604, 612, 614) [5.10 -] - R |
| SM9925 | Seat Leon (5F1), Leon SC (5F5), Leon ST (5F8) [9.12 -] - R | SM1051 | Volkswagen Polo VI (AW1, BZ1) [6.17 -] - F |
| SM1051 | Seat Tarraco (KN2) [9.18 -] - F | | Volkswagen Tiguan Allspace (BW2, BJ2) [4.17 -] - F |
| SM1708 | Skoda Fabia III (NJ3, NJ5) [8.14 -] - F | | |
| SM9704 | Skoda Fabia III (NJ3, NJ5) [8.14 -] - R | | |
| SM5674 | Smart Cabrio (450) [3.00 - 1.04] - F | | |
| SM5674 | Smart City-Coupé (450) [7.98 - 1.04] - F | | |
| SM5674 | Smart Cross-blade (450) [6.02 - 12.03] - F | | |
| SM1548 | Smart Fortwo II (451) [1.07 -] - R | | |
| SM5674 | Smart Roadster (452) [4.03 - 11.05] - F | | |
| SM5674 | Smart Roadster Coupé (452) [4.03 - 11.05] - F | | |
| # SM9930 | Suzuki Splash (EX) [9.07 -] - R | | |
| # SM9930 | Suzuki Swift III (MZ, EZ) [2.05 -] - R | | |
| # SM1049 | Suzuki Swift IV (FZ, NZ) [10.10 -] - F | | |
| # SM9930 | Suzuki Swift IV (FZ, NZ) [10.10 -] - R | | |
| SM9913 | Toyota Aygo (WNB1_, KGB1_) [2.05 -] - R | | |
| SM1930 | Toyota Aygo (PAB4_, KGB4_) [5.14 -] - F | | |
| SM9913 | Toyota Aygo (PAB4_, KGB4_) [5.14 -] - R | | |
| # SM9938 | Toyota Verso [4.09 -] - R | | |
| # SM9930 | Vauxhall Agila Mk II (B) [9.07 -] - R | | |
| # SM5888 | Vauxhall Astra K (B16) [7.15 -] - F | | |

NEW ADDITIONS

New Part No./Neue Teile No/ Nouveau No.

◇ : in preparation/in Vorbereitung/en études

| | VEHICLE FAHRZEUG VEHICULE | | VEHICLE FAHRZEUG VEHICULE |
|-----------------------|---|------------|--|
| PROTECTION KIT | | # 910246 | Ford Grand C-Max, |
| | A1 Sportback (8X1, 8XK), | # 910313 | Grand C-Max Van (DXA) [12.10 -] - R |
| # 910256 | Audi A3 (8V1, 8VK), A3 Sportback (8VA, 8VF), | 910081 | Ford Focus (DAW, DBW, DFW) [10.98 - 11.04] - R |
| | A3 Limousine (8VS, 8VM) [4.12 -] - R | # 910282 | Ford Ka, Sport Ka, Street Ka (RB) [9.96 - 11.08] - F |
| # 910257 | Audi A3 (8V1, 8VK), A3 Sportback (8VA, 8VF), | | Ford Ka, Sport Ka, |
| | A3 Limousine (8VS, 8VM) [4.12 -] - R | # 910262 | Street Ka (RB, RL2) [2.01 - 11.08] - F |
| # 910332 | Audi A3 Sportback (8YA) [6.20 -] - R | # 912047 | Ford Kuga I [3.08 -] - F |
| # 910332 | Audi Q3 (F3B), Q3 Sportback (F3N) [7.18 -] - R | # 912065 | Honda Accord VI (CG2, CG4) [2.98 - 1.03] - F |
| 910002 | Audi S3 (8P1, 8PA) [6.08 - 3.13] - R | # 910265 | Honda Accord VII (CL_, CM_, CN_) [2.03 -] - F |
| 910180 | Audi S3 (8P1, 8PA) [6.08 - 3.13] - R | # 910265 | Honda Accord VIII (CU, CW) [6.08 -] - F |
| # 910235 | BMW 1 Series (F21, F20) [11.10 -] - R | # 910266 | Honda Accord VIII (CU, CW) [6.08 -] - R |
| # 910235 | BMW 2 Series (F22) [10.13 -] - R | # 910267 | Honda City (GM2, GM3) [9.08 -] - F |
| # 910235 | BMW 2 Series (F23) [3.14 -] - R | # 910347 | Honda CR-V III (RE) [1.07 - 11] - F |
| # 910233 | BMW 2 Series Active Tourer (F45) [11.13 -] - F | # 910267 | Honda CR-Z (ZF) [6.10 -] - F |
| # 910233 | BMW 2 Series Gran Tourer (F46) [7.14 -] - F | # 910267 | Honda Insight (ZE_) [4.09 -] - F |
| # 910235 | BMW 3 Series Gran Turismo (F34) [3.13 -] - R | # 910267 | Honda Jazz III (GE) [7.08 -] - F |
| # 910235 | BMW 4 Series (F32) [7.13 -] - R | 910270 | Hyundai Coupé (J2, RD) [6.96 - 4.02] - R |
| # 910237 | BMW 4 Series Gran Coupe (F36) [3.14 -] - R | 910270 | Hyundai Elantra (HD) [11.05 - 11.06] - F |
| # 910233 | BMW X1 (F48) [11.14 -] - F | 910249 | Hyundai Getz (TB) [8.02 - 6.09] - F |
| # 910316 | Chevrolet - Daewoo Aveo (T300) [3.11 -] - F | # 910340 ◇ | Hyundai i10 (BA, IA) [8.13 -] - F |
| # 910327 | Chevrolet - Daewoo Aveo (T300) [3.11 -] - F | # 910335 ◇ | Hyundai i10 (BA, IA) [8.13 -] - R |
| # 910285 | Chevrolet - Daewoo Captiva (C100, C400) [6.06 -] - F | # 910340 ◇ | Hyundai Grand i10 [8.15 -] - F |
| # 910327 | Chevrolet - Daewoo Cobalt II (69) [1.13 -] - F | # 910335 ◇ | Hyundai Grand i10 [8.15 -] - R |
| # 912048 | Chevrolet - Daewoo Trax [12.12 -] - R | # 910284 | Hyundai i30 II (GD) [11.11 -] F |
| # 912049 | Chevrolet - Daewoo Trax [12.12 -] - R | # 910287 | Hyundai i30 II (GD) [11.11 -] F |
| # 912053 | Citroën C4 Aircross [4.12 -] - F | # 910284 | Hyundai i30 CW II (GD) [6.12 -] F |
| # 910349 | Citroën C4 Aircross [4.12 -] - R | # 910287 | Hyundai i30 CW II (GD) [6.12 -] F |
| # 910279 | Citroën C4 Picasso II, C4 Grand Picasso II [2.13 - 6.17] - F | # 910284 | Hyundai i30 Coupé [5.13 -] - F |
| # 912053 | Citroën C-Crosser (EP) [2.07 -] - F | # 910287 | Hyundai i30 Coupé [5.13 -] - F |
| # 910349 | Citroën C-Crosser (EP) [2.07 -] - R | 910250 | Hyundai i40 (VF) [3.12 -] - F |
| # 910259 | Citroën DS3 [11.09 - 7.15] - F | 910250 | Hyundai i40 CW (VF) [7.11 - 12.14] - F |
| # 910314 | Citroën DS4 [4.11 - 7.15] - F | # 910293 ◇ | Hyundai ix35 (LM, EL, ELH) [8.09 -] - R |
| # 910332 | Cupra Formentor (KM7) [7.20 -] - R | # 910320 | Hyundai Sonata V (NF) [1.05 -] - R |
| 910009 | Dacia Sandero Stepway II [10.12 -] - F | # 910318 | Hyundai Tucson (TL, TLE) [6.15 -] - R |
| # 910259 | DS 3 (SA_, SB_) [4.15 - 7.19] - F | # 910271 | Kia Carnival III, Grand Carnival III, Sedona III (VQ) [9.06 -] - F |
| 910067 | DS 4 [7.15 -] - F | # 910284 | Kia Cee'd (JD) [5.12 -] - F |
| 910095 | DS 4 [7.15 -] - R | # 910287 | Kia Cee'd (JD) [5.12 -] - F |
| 910198 | DS 5 [4.15 -] - F | # 910288 | Kia Cee'd (JD) [6.13 -] - F |
| # 910246 | Ford C-Max II (DXA/CB7, DXA/CEU) [4.10 -] - R | # 910284 | Kia Cee'd Sportswagon (JD) [9.12 -] - F |
| | | # 910287 | Kia Cee'd Sportswagon (JD) [9.12 -] - F |
| | | # 910335 ◇ | Kia Picanto (TA) [5.11 -] - R |
| | | # 910293 ◇ | Kia Sportage (10-) (SL) [6.10 -] - R |
| | | # 910318 | Kia Sportage IV (16-) (QL, QLE) [9.15 -] - R |

NEW ADDITIONS

New Part No/Neue Teile No/ Nouveau No.

◇ : in preparation/in Vorbereitung/en études

| KYB | VEHICLE FAHRZEUG VEHICULE | KYB | VEHICLE FAHRZEUG VEHICULE |
|------------|--|------------|---|
| #910272 | Lancia Ypsilon (312) [5.11 -] - F | #910323 | Mitsubishi Outlander III (GF_W, GG_W) [8.12 -] - F |
| #910326 | Land Rover Discovery Sport (L550) [9.14 -] - F | #910331 | Mitsubishi Space Star (DG_A) [6.98 -] - R |
| #910326 | Land Rover Freelander 2 (FA) [10.06 -] - F | #910350 | Nissan Almera (N15) [7.95 - 12.99] - F |
| #910322 | Land Rover Freelander 2 (FA) [10.06 -] - R | #910353 | Nissan Almera (N15) [7.95 - 12.99] - R |
| #910326 | Land Rover | #910351 | Nissan Almera Tino (V10) [5.00 -] - F |
| | Range Rover Evoque (L538) [6.11 - 12.19] - F | #910352 | Nissan Murano I (Z50) [3.05 -] - F |
| #910273 | Mazda 6 (GH) [8.07 -] - F | #910352 | Nissan Primera (P12) [1.02 -] - F |
| #910325 | Mazda CX-7 (ER) [11.06 -] - F | #910352 | Nissan Primera Traveller (WP 12) [1.02 -] - F |
| #910325 | Mazda CX-9 (TB) [1.07 -] - F | #910365 ◇ | Nissan Qashqai II (J11, J11_) [11.13 -] - F |
| #910275 | Mercedes Benz A-Class (W176) [6.12 - 5.18] - F | 910252 | Nissan Sentra (B17R) [8.14 -] - F |
| #910275 | Mercedes Benz | #910351 | Nissan X-Trail (T30) [7.01 - 5.07] - F |
| | B-Class (W246, W242) [11.11 - 12.18] - F | #910354 | Nissan X-Trail (T30) [7.01 - 5.07] - R |
| 910274 | Mercedes Benz CLA-Class (C117) [1.13 - 3.19] - F | #910276 | Opel Adam, Adam Rocks (M13) [10.12 - 2.19] - R |
| #910275 | Mercedes Benz CLA-Class (C117) [1.13 - 3.19] - F | #912052 | Opel Agila (H08) [9.07 -] - F |
| 910274 | Mercedes Benz | #910285 | Opel Antara A (L07) [7.06 -] - F |
| | CLA-Class Shooting Brake (X117) [1.15 - 3.19] - F | 910203 | Opel Corsa E (X15) [3.15 -] - F |
| #910275 | Mercedes Benz | #910276 | Opel Corsa E [9.14 -] - R |
| | CLA-Class Shooting Brake (X117) [1.15 - 3.19] - F | #912048 | Opel Mokka / Mokka X (J13) [6.12 -] - R |
| #910275 | Mercedes Benz GLA-Class (X156) [12.13 -] - F | #912049 | Opel Mokka / Mokka X (J13) [6.12 -] - R |
| #910243 | Mini Clubman (F54) [11.14 -] - F | #910278 | Opel Movano (B) [5.10 -] - F |
| #910243 | Mini Countryman (F60) [10.16 -] - F | #910259 | Peugeot 208 I (CA_, CC_) [3.12 -] - F |
| #912053 | Mitsubishi ASX (GA_W_) [2.10 -] - F | #910279 | Peugeot 308 II, 308 SW II [9.13 -] - F |
| #910349 | Mitsubishi ASX (GA_W_) [2.10 -] - R | 910067 | Peugeot 3008 (0U_) [6.09 - 6.14] - F |
| #910331 | Mitsubishi Carisma (DA) [5.95 - 6.06] - R | #910314 | Peugeot 3008 (0U_) [6.09 - 6.14] - F |
| #910331 | Mitsubishi Colt IV (C_A) [12.91 - 96] - R | #912053 | Peugeot 4007 (GP) [2.07 -] - F |
| #910331 | Mitsubishi Colt V (C_) [96 - 6.03] - R | #910349 | Peugeot 4007 (GP) [2.07 -] - R |
| #912051 | Mitsubishi Colt VI (Z30) [6.04 - 6.12] - F | #912053 | Peugeot 4008 [5.12 -] - F |
| #912053 | Mitsubishi Grandis (NA_W) [4.04 -] - F | #910349 | Peugeot 4008 [5.12 -] - R |
| #910331 | Mitsubishi Lancer (CB_A, CD_A) [5.92 -] - R | #910314 | Peugeot 5008 I (0U_, 0E_) [6.09 - 11.13] - F |
| #910331 | Mitsubishi Lancer (CK_) [96 - 6.03] - R | 910009 | Renault Captur (H5_) [3.16 -] - F |
| #910331 | Mitsubishi Lancer (CT9A) [00 - 2.03] - R | #910365 ◇ | Renault Kadjar (HA_, HL_) [6.15 -] - F |
| #910349 | Mitsubishi Lancer (CS_A) [6.03 -] - R | #910278 | Renault Master III (JV, FV, EV, HV, UV) [2.10 -] - F |
| #910328 | Mitsubishi Lancer Estate (CS_W) [6.03 - 10.08] - R | 910009 | Renault Sandero Stepway II (B8_) [11.13 -] - F |
| #912053 | Mitsubishi Lancer (CY_A), | #910280 | Seat Arosa (6H) [97 - 6.04] - R |
| | Lancer Sportback (CX_A) [3.07 -] - F | #910281 | Seat Arosa (6H) [97 - 6.04] - R |
| #910349 | Mitsubishi Lancer (CY_A), | #910332 | Seat Leon (5F1), Leon SC (5F5), |
| | Lancer Sportback (CX_A) [3.07 -] - R | | Leon ST (5F8) [9.12 -] - R |
| #910348 | Mitsubishi Pajero III / Shogun III / | #910332 | Seat Leon (KL1), |
| | Montero III (V_) [2.00 - 1.07] - F | | Leon Sportstourer (KL8) [11.19 -] - R |
| #910348 | Mitsubishi Pajero IV / Shogun IV / | #910332 | Seat Tarraco (KN2) [9.18 -] - R |
| | Montero IV (V8_, V9_) [2.07 -] - F | #910332 | Skoda Kodiaq (NS7, NV7) [10.16 -] - R |
| #910330 | Mitsubishi Outlander I (CU_W) [5.03 - 10.06] - R | #910332 | Skoda Octavia III (5E3) [11.12 -] - R |
| #912053 | Mitsubishi Outlander II (CW_W) [11.06 - 12.13] - F | #910332 | Skoda Octavia III Combi (5E5) [11.12 -] - R |
| #910349 | Mitsubishi Outlander II (CW_W) [11.06 - 12.13] - R | | |

NEW ADDITIONS

New Part No/Neue Teile No/ Nouveau No.

◇ : in preparation/in Vorbereitung/en études

|  | VEHICLE FAHRZEUG VEHICULE | |
|---|--|--|
| #910332 | Skoda Octavia IV (NX3), Octavia IV Combi (NX5) [11.19 -] - R | |
| #910332 | Skoda Superb III (3V3, 3V5) [3.15 -] - R | |
| #912051 | Smart Forfour I (454) [1.04 - 6.06] - F | |
| #910286 | Subaru Forester (SH) [1.08 -] - R | |
| #910286 | Subaru Forester (SJ) [3.13 -] - R | |
| #910286 | Subaru Impreza (GR) [1.08 -] - R | |
| #910286 | Subaru Legacy (BM, BR) [9.09 -] - R | |
| #910286 | Subaru Outback (BM, BR) [9.09 -] - R | |
| #910286 | Subaru Outback (BS) [10.14 -] - R | |
| #912052 | Suzuki Splash (EX) [9.07 -] - F | |
| 912023 | Toyota Aygo (PAB4_, KGB4_) [5.14 -] - R | |
| #910283 | Toyota Corolla (_E12_) [10.01 -] - F | |
| #910283 | Toyota Corolla Verso (CDE120) [9.01 - 12.03] - F | |
| #917006 | Toyota Land Cruiser [9.02 -] - F | |
| #910276 | Vauxhall Adam, Adam Rocks (M13) [10.12 - 4.19] - R | |
| #912052 | Vauxhall Agila Mk II (B) [9.07 -] - F | |
| #910285 | Vauxhall Antara A (L07) [8.06 -] - F | |
| 910203 | Vauxhall Corsa Mk IV (E) (X15) [4.15 -] - F | |
| #910276 | Vauxhall Corsa Mk IV (E) (X15) [8.14 -] - R | |
| #912048 | Vauxhall Mokka / Mokka X (J13) [6.12 -] - R | |
| #912049 | Vauxhall Mokka / Mokka X (J13) [6.12 -] - R | |
| #910278 | Vauxhall Movano (B) [5.10 -] - F | |
| #910332 | Volkswagen Arteon, Arteon Shooting Brake (3H_) [3.17 -] - R | |
| #910332 | Volkswagen Golf VII (5G1, BQ1, BE1, BE2) [8.12 -] - R | |
| #910332 | Volkswagen Golf VII Variant (BA5, BV5) [4.13 -] - R | |
| #910332 | Volkswagen Golf Alltrack VII Variant (BA5, BV5) [12.14 -] - R | |
| #910332 | Volkswagen Golf Sportsvan (AM1, AN1) [2.14 -] - R | |
| #910332 | Volkswagen Golf VIII (CD1), Golf VIII Variant (CG5) [7.19 -] - R | |
| #910332 | Volkswagen Golf Alltrack VIII (CG5) [11.20 -] - R | |
| #910280 | Volkswagen Lupo (6X, 6E) [98 -] - R | |
| #910281 | Volkswagen Lupo (6X, 6E) [98 -] - R | |
| #910332 | Volkswagen Passat (3G2, CB2), Passat Variant (3G5, CB5) [8.14 -] - R | |
| #910332 | Volkswagen Passat Alltrack (3G5, CB5) [5.15 -] - R | |
| #910332 | Volkswagen Tiguan (AD1, AX1) [1.16 -] - R | |
| #910332 | Volkswagen Tiguan Allspace (BW2, BJ2) [4.17 -] - R | |
| #910332 | Volkswagen T-Roc (A11) [7.17 -] - R | |
| #910332 | Volkswagen T-Roc (AC7) [12.19 -] - R | |
| 910154 | Volkswagen Up, Load Up (12_, BL_) [7.13 -] - F | |

A vertical grey bar runs down the center of the page, serving as a background for the section header.

VEHICLE APPLICATIONS



| MODEL FAHRZEUG MODELE | YEAR JAHR ANNEE | FRONT/VORNE/AVANT | | | | REAR/HINTEN/ARRIERE | | | |
|---|-----------------------|--|-----------------------------|--------------------------------|--|-----------------------------|-----------------------------|--------------------------------|--|
| | | PREMIUM Twin-tube Oil | EXCEL-G Twin-tube Gas | GAS-A-JUST Mono-tube Gas | | PREMIUM Twin-tube Oil | EXCEL-G Twin-tube Gas | GAS-A-JUST Mono-tube Gas | |
| Alfa Romeo (I) | | | | | | | | | |
| Alfa 6 (119) | | | | | | | | | |
| | 4.79 - 12.86 | 443127 | | | | | | | |
| Alfa 33 (905/907A) / Alfa 33 Sportwagon (905A/907B) | | | | | | | | | |
| 1.2, 1.3, 1.3 S, 1.5 1.5 Ti, 1.5 Quadrifoglio 1.7 Quadrifoglio, 1.8 TD Incl. Giardinetta Exc. (4WD) | (905) | 6.83 - 7.86 6.83 - 7.86 - 2.87 | | | | | 343231 | | |
| 1.2, 1.3, 1.3 S, 1.5 1.5 Ti, 1.5 Quadrifoglio Incl. Giardinetta Exc. (4WD) | (905) | 6.86 - 7.87 6.86 - 7.87 | | | | | 343231 | | |
| 1.2, 1.3, 1.3 S, 1.5 1.5 Ti, 1.5 Quadrifoglio 1.7 Quadrifoglio, 1.8 TD 1.7 i.e. Incl. Giardinetta Exc. (4WD) | (905) | 3.87 - 1.90 3.87 - 1.90 3.87 - 1.90 88 - 1.90 | | | | | 343231 | | |
| Exc. 1.7 i.e. 16V, 1.8 TD | (907) | 90 - 1.93 | | | | | 343231 | | |
| Exc. 1.7 i.e. 16V, 1.8 TD | (907) | 2.93 - 9.94 | | | | | 343231 | | |
| 1.7 i.e. 16V | (907) | 1.90 - 3.90 | | | | | 343231 | | |
| 1.7 i.e. 16V | (907) | 4.90 - 9.94 | | | | | 343231 | | |
| 1.8 TD | (907) | 1.90 - 9.94 | | | | | 343231 | | |
| Alfa 75, 90 | | | | | | | | | |
| Alfa 75 1.6, 1.8, 2.0, 2.5 i, 3.0 i, 2.0 TD, 2.4 TD Alfa 90 1.8, 2.0, 2.0 i, 2.5 i, 2.4 TD | (162B) (162) | 5.85 - 92 10.84 - 89 | 443248 | 343235 | | 443249 | 343236 | | |
| Alfa 145/146 | | | | | | | | | |
| 1.4 (66 kW), 1.6 (76 kW) 1.7 16V (95 kW) | (930) | 94 - 97 | | | | | 344115 | 554077 | |
| 1.4 (76 kW), 1.6 (82, 88 kW) 1.8 (103, 106 kW) 1.9 TD 2.0 T.S., 2.0 Quadrifoglio | (930) | 97 - 1.01 97 - 1.01 94 - 1.01 | | | | | 344115 | 554077 | |
| 1) | | | | | | | | | |



Alfa Romeo

| MODEL FAHRZEUG MODELE | YEAR JAHR ANNEE | FRONT/VORNE/AVANT | | | | REAR/HINTEN/ARRIERE | | | |
|---|-----------------------|-----------------------------|-----------------------------|--------------------------------|--|-----------------------------|-----------------------------|--------------------------------|--|
| | | PREMIUM Twin-tube Oil | EXCEL-G Twin-tube Gas | GAS-A-JUST Mono-tube Gas | | PREMIUM Twin-tube Oil | EXCEL-G Twin-tube Gas | GAS-A-JUST Mono-tube Gas | |
| Alfa Romeo (I) | | | | | | | | | |
| Alfa 145/146 | | | | | | | | | |
| 1.9 TD (930) | 10.94 - 11.96 | | | | | | 344115 | 554077 | |
| | | 916024▼ 910085 | | | | | | | |
| 1.9 JTD (930) | 02.99 - 01.01 | | | | | | 344115 | 554077 | |
| | | 916024▼ 910085 | | | | | | | |
| Alfa 147 | | | | | | | | | |
| 1.6, 2.0, 1.9 JTD, 1.9 JTDM, 3.2 (937) | 00 - | | 340025 | | | | 339744 | | |
| | | 910001 | SM2005 | | | 910085 | SM6000 | | |
| Alfa 155 | | | | | | | | | |
| Twin Spark 1.6, 1.7, 1.8, 2.0 1.9 Turbo Diesel Exc. | (167) 92 - 97 | | | | | | 344115 | 554077 | |
| | | 916002▼ 910086▼ | | | | | | | |
| 2.5 Turbo Diesel Exc. | (167) 93 - 97 | | | | | | 344115 | 554077 | |
| | | 916002▼ 910086▼ | | | | | | | |
| 2.5 V6 Exc. | (167) 92 - 97 | | | | | | 344115 | 554077 | |
| | | 916002▼ 910086▼ | | | | | | | |
| 2.0 Turbo 16V Q4 (4WD) Exc. | (167) 92 - 96 | | | | | | | 554077 | |
| | | 916002▼ 910086▼ | | | | | | | |
| Alfa 156 | | | | | | | | | |
| Twin Spark 1.6, 1.8, 2.0 2.5 V6 24V 1.9 JTD, 2.4 JTD Exc. Sport sus. | (932) 9.97 - 05 | | 340025 | | | | 339745 | | |
| | | 910001 | SM2005 ¹⁾ | | | 910085 ¹⁾ | SM6000 ²⁾ | | |
| Sport sus. Twin Spark 1.6, 1.8, 2.0 2.5 V6 24V 1.9 JTD, 2.4 JTD | (932) 9.97 - 05 | | | | | | | | |
| | | 910001 | SM2005 ¹⁾ | | | 910085 ¹⁾ | SM6000 ²⁾ | | |
| 1) Incl. 3.2 GTA 2) → 0116246 Incl. 3.2 GTA | | | | | | | | | |
| Alfa 156 Sportwagon | | | | | | | | | |
| Twin Spark 1.6, 1.8, 2.0 2.5 V6 24V 1.9 JTD, 2.4 JTD Exc. , Self leveling | (932) 5.00 - 05 | | 340025 | | | | 339745 | | |
| | | 910001 | SM2005 ¹⁾ | | | 910085 ³⁾ | SM6000 ²⁾ | | |
| 1) Incl. 1.9 JTD 16V (4WD), 3.2 GTA 2) → 0116246 Incl. 3.2 GTA 3) Incl. 3.2 GTA | | | | | | | | | |

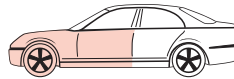

| MODEL FAHRZEUG MODELE | YEAR JAHR ANNEE | FRONT/VORNE/AVANT | | | | REAR/HINTEN/ARRIERE | | | |
|--|---|-----------------------------|-----------------------------|--------------------------------|--|-----------------------------|-----------------------------|--------------------------------|--|
| | | PREMIUM Twin-tube Oil | EXCEL-G Twin-tube Gas | GAS-A-JUST Mono-tube Gas | | PREMIUM Twin-tube Oil | EXCEL-G Twin-tube Gas | GAS-A-JUST Mono-tube Gas | |
| Alfa Romeo (I) | | | | | | | | | |
| Alfa 159 (939) | | | | | | | | | |
| 1.8 MPI, 1.9 JTS, 2.2 JTS, 3.2 JTS (939 AX) 1.9 JTDM, 2.0 JTDM, 2.4 JTDM | 9.05 - 11.11 | | 341700 | | | | 341702 | | |
| | | 910182 | SM1041 | | | | | | |
| 2.4 JTDM Q4 (939 AX) 3.2 JTS Q4 | 5.07 - 11.11 12.05 - 11.11 | | 341701 | | | | 341703 | | |
| | | 910182 | SM1041 | | | | | | |
| Alfa 159 Sportwagon (939) | | | | | | | | | |
| 1.8 MPI, 1.8 Tbi, 1.9 JTS, 2.2 JTS (939 AX) 3.2 JTS, 1.9 JTDM, 2.0 JTDM, 2.4 JTDM | 3.06 - 11.11 | | 341700 | | | | 341702 | | |
| | | 910182 | SM1041 | | | | | | |
| 2.4 JTDM Q4 (939 BX) 3.2 JTS Q4 | 5.07 - 11.11 3.06 - 11.11 | | 341701 | | | | 341703 | | |
| | | 910182 | SM1041 | | | | | | |
| Alfa 164 | | | | | | | | | |
| 2.0 Twin Spark/Turbo (164) 2.5 Turbo Diesel 3.0 V6 → 6183988 Exc. , Quadrifoglio | 87 - 10.90 | | | | | | 334801 | | |
| | | | | | | 913113 ▼ | SM9803 | | |
| | | | | | | 910085 | | | |
| 2.0 Twin Spark/Turbo (164) 2.0 V6 Turbo 2.5 Turbo Diesel 3.0 V6 6183989 → Exc. , Quadrifoglio, Q4 | 11.90 - 9.98 91 - 9.98 11.90 - 9.98 11.90 - 9.98 | | | | | | 334801 | | |
| | | | | | | 913113 ▼ | SM9803 | | |
| | | | | | | 910085 | | | |
| Alfa 166 | | | | | | | | | |
| 2.0 T.Spark, 2.0 V6 (936) 2.5 V6 24V, 3.0 V6 24V, 3.2 V6 24V 2.4 JTD | 9.98 - 07 | | 341910 | | | | 341911 | | |
| | | 910181 | SM2005 | | | | | | |
| Alfa Brera (939) | | | | | | | | | |
| 2.4 JTDM (939 BX) | 1.06 - | | 341700 | | | | 341702 | | |
| | | 910182 | SM1041 | | | | | | |
| 1.8 Turbo (939 DX) 2.2 JTS 3.2 JTS 3.2 JTS Q4 Exc. Sport sus. | 1.06 - | | 341701 | | | | 341703 | | |
| | | 910182 | SM1041 | | | | | | |
| Alfa Sud | | | | | | | | | |
| Sprint Ti Quadrifoglio (Alfa 33-sus.) (901) | 84 - 90 | | | | | | 343231 | | |
| | | | | | | | | | |
| Alfetta | | | | | | | | | |
| 1.6 (116) 1.6 GT 1.8 1.8 GT 2.0 2.0 GTV, 2.5 GTV, 2.0 Turbo Delta Turbo Diesel 2.5-V6 GTV | 75 - 84 76 - 85 72 - 84 74 - 85 77 - 84 76 - 85 79 - 86 80 - 11.84 | 443127 | | | | 443128 | | | |
| | | | | | | | | | |



Alfa Romeo

| MODEL FAHRZEUG MODELE | YEAR JAHR ANNEE | FRONT/VORNE/AVANT | | | | REAR/HINTEN/ARRIERE | | | |
|--|-----------------------|---|-----------------------------|--------------------------------|--|-----------------------------|-----------------------------|--------------------------------|--|
| | | PREMIUM Twin-tube Oil | EXCEL-G Twin-tube Gas | GAS-A-JUST Mono-tube Gas | | PREMIUM Twin-tube Oil | EXCEL-G Twin-tube Gas | GAS-A-JUST Mono-tube Gas | |
| Alfa Romeo (I) | | | | | | | | | |
| Alfetta | | | | | | | | | |
| 2.0 GTV 2.5 GTV | (116) | 85 - 90 | 443248 | 343235 | | 443249 | 343236 | | |
| Arna | | | | | | | | | |
| 1.2 SL, 1.3, 1.5 Ti | (920) | 11.84 - 86 | | | | | 342008 | | |
| Giulia (105_) | | | | | | | | | |
| 1300 1600 1750 Berlina, GTV, Spider Montreal 2000 Berlina, GTV, Spider Diesel | (105_) | 67 - 80 67 - 74 68 - 72 70 - 76 71 - 76 76 - 78 | 443114 | | | 443126 | | | |
| Giulia (952_) | | | | | | | | | |
| 2.0 Q4, 2.0 Super, 2.0 Veloce 2.9 Quadrifoglio, 2.2 D, 2.2 D Q4 Exc. | (952_) | 10.15 - | | | | | | 5538003 | |
| Giulietta | | | | | | | | | |
| 1.3, 1.6 1.8 2.0 | (113, 116) | 77 - 86 79 - 86 80 - 86 | 443127 | | | 443128 | | | |
| Incl. Sport sus. Exc. | (940) | 4.10 - | | 339850 L 339851 R | | | 344665 | | |
| | | | 910230 | | | | | | |
| GT | | | | | | | | | |
| 1.8i 16V 1.9 JTD 16V 2.0 JTS 3.2 V6 24V | (937) | 1.04 - 9.03 - 9.03 - 9.03 - | | 340025 | | | | | |
| | | | 910001 SM2005 | | | 910085 SM6000 | | | |
| GTV | | | | | | | | | |
| 1.8 16V Twin Spark 2.0 16V Twin Spark | (916) | 11.94 - 03 | | | | | | 553205 | |
| 2.0 V6 Turbo | (916) | 11.94 - 03 | | | | | | 553205 | |
| 3.0 V6 Turbo | (916) | 11.94 - 03 | | | | | | 553205 | |
| Mito | | | | | | | | | |
| 1.4 (58 kW), 1.4 MultiAir (125 kW) 1.4 BiFuel, 1.4 TJet 1.4 Turbo MultiAir (120 kW) 1.4 Turbo MultiAir (99 kW) 1.3 Multijet (66 kW, 70 kW) 1.6 JTDM Exc. | (955) | 8.08 - 11.10 8.08 - 3.11 10.09 - 11.10 10.09 - 3.11 8.08 - 11.10 8.08 - 3.11 | | 339761 L 339760 R | | | 348025 | | |
| | | | 910200 SM1820 | | | SM9806 L SM9805 R | | | |



| MODEL FAHRZEUG MODELE | YEAR JAHR ANNEE | FRONT/VORNE/AVANT | | | | REAR/HINTEN/ARRIERE | | | |
|--|-----------------------|-----------------------------|--------------------------------|--------------------------------|--|-----------------------------|-----------------------------|--------------------------------|--|
| | | PREMIUM Twin-tube Oil | EXCEL-G Twin-tube Gas | GAS-A-JUST Mono-tube Gas | | PREMIUM Twin-tube Oil | EXCEL-G Twin-tube Gas | GAS-A-JUST Mono-tube Gas | |
| Alfa Romeo (I) | | | | | | | | | |
| Mito | | | | | | | | | |
| 1.4 (70 kW), 1.4 MultiAir (77 kW) Exc. | (955) | 9.08 - 11.10 | 910200 | SM1820 | | | 348025 | SM9806 L SM9805 R | |
| 0.9, 0.9 TwinAir 1.4, 1.4 MultiAir (77 kW) 1.3 Multijet (kW : 59, 62, 70) Exc. | (955) | 12.10 - | 910200 | SM1820 339833 L 339832 R | | | 343459 | SM9806 L SM9805 R | |
| 1.4 MultiAir (125 kW) 1.4 Turbo MultiAir (120 kW) Exc. | (955) | 12.10 - | 910200 | SM1820 339761 L 339760 R | | | 343459 | SM9806 L SM9805 R | |
| 1.4 BiFuel, 1.4 TB, 1.4 TJet 1.4 Turbo MultiAir (99 kW) 1.6 JTDM Exc. , | (955) | 4.11 - | 910200 | SM1820 339831 L 339830 R | | | 3458002 | SM9806 L SM9805 R | |
| Spider | | | | | | | | | |
| 1.8 16V Twin Spark 2.0 16V Twin Spark | (916) | 11.94 - 4.05 | | | | | | 553205 | |
| 3.0 V6, 3.2 V6 | (916) | 11.94 - 4.05 | | | | | | 553205 | |
| 1.8 TBI 2.0 JTDM 2.4 JTDM | (939) | 9.06 - | 910182 | SM1041 341701 | | | 341702 | | |
| 2.2 JTS 3.2 JTS (24V) | (939) | 9.06 - | 910182 | SM1041 341701 | | | | | |
| Stelvio | | | | | | | | | |
| 2.0 (148 kW, 206 kW) 2.2 D, 2.2 JTDM Incl. Sport Setting Exc. Sport sus., Active sus. | (949_) | 12.16 - | | | | | | 5538004 | |
| Audi (D) | | | | | | | | | |
| 50 | | | | | | | | | |
| | (86) | 9.74 - 78 | 663035 ¹⁾ 910088 | SM1703 | | 441019 | 341023▼ 351004▼ | 915412 ²⁾ | |
| 1) 2) 915412 : not for 441019, 341023 and 351004 | | | | | | | | | |
| 80 (72-78) | | | | | | | | | |
| | (80, 82, B1) | 72 - 8.78 | 664001 | | | | | | |



Audi

| MODEL FAHRZEUG MODELE | YEAR JAHR ANNEE | FRONT/VORNE/AVANT | | | Wrench icon | REAR/HINTEN/ARRIERE | | | Wrench icon |
|--|-----------------------|-----------------------------|-----------------------------|--------------------------------|-------------|-----------------------------|-----------------------------|--------------------------------|-------------|
| | | PREMIUM Twin-tube Oil | EXCEL-G Twin-tube Gas | GAS-A-JUST Mono-tube Gas | | PREMIUM Twin-tube Oil | EXCEL-G Twin-tube Gas | GAS-A-JUST Mono-tube Gas | |
| Audi (D) | | | | | | | | | |
| 80 (72-78) | | | | | | | | | |
| Variant (80, 82, B1) | 75 - 87.8 | 664001 | | | ⏏ | | | | ⊕ ⊖ |
| 80/90 , 80 Variant/Avant (78-91) | | | | | | | | | |
| 80 (Exc. Quattro) (81) | 9.78 - 86 | 665030 ¹⁾²⁾ | 365500 | | ⏏ | 441022 ²⁾ | 341003 | | ⊥ ⊖ |
| 90 (Exc. Quattro) (81) | 10.84 - 86 | | 375008 ²⁾ | | | | | | |
| | | 910088 | SM1702 | | | | | | |
| 80 Quattro (81) | 9.83 - 8.86 | 665030 ¹⁾²⁾ | 365500 | | ⏏ | 666002 ¹⁾ | 366006 | | ⏏ |
| 90 Quattro (81) | 9.84 - 12.86 | | 375008 ²⁾ | | | | | | |
| Exc. Sport sus. | | 910088 | SM1702 | | | | | | |
| 80 (89, 8A) | 10.86 - 8.91 | 665030 ¹⁾²⁾ | 365500 | | ⏏ | 441022 ²⁾ | 341003 | | ⊥ ⊖ |
| 90 (89, 8A) | 87 - 8.91 | | 375008 ²⁾ | | | | | | |
| Exc. Quattro, Sport sus., 2.3, 2.3 20V | | 910088 | SM1702 | | | | | | |
| 80 Quattro (89, 8A) | 9.86 - 8.91 | 665030 ¹⁾²⁾ | 365500 | | ⏏ | 666002 ¹⁾ | 366006 | | ⏏ |
| 90 Quattro (89, 8A) | 1.87 - 8.91 | | 375008 ²⁾ | | | | | | |
| Exc. Sport sus., 2.3, 2.3 20V | | 910088 | SM1702 | | | | | | |
| 1) Exc. 2.0, 2.3 2) | | | | | | | | | |
| 80 , 80 Variant/Avant (91-95) | | | | | | | | | |
| 1.6, 2.0, 2.0 E, 2.3 E, (8C, B4) | 9.91 - 95 | 665030 ¹⁾²⁾ | 365500 | | ⏏ | 441083 | 341130 | | ⊥ ⊖ |
| 1.9 TD, 1.9 TDI | | | 375008 ²⁾ | | | | | | |
| Exc. Sport sus., Quattro, | | 910088 | SM1702 | | | | SM9705 | | |
| 2.6 E, 2.8 E (8C, B4) | 9.91 - 95 | | 365500 | | ⏏ | | 341130 | | ⊥ ⊖ |
| Exc. Sport sus., Quattro | | 910088 | 375008 ²⁾ | | | | SM9705 | | |
| Sport sus. (8C, B4) | 9.91 - 95 | | 365500 | | ⏏ | | 341132▼ | | ⊥ ⊖ |
| Exc. Quattro | | | 375008 ²⁾ | | | | SM9705 | | |
| | | | SM1702 | | | | | | |
| Quattro (8C, B4) | 92 - 95 | | 365500 | | ⏏ | | | | |
| Incl. Sport sus. | | | 375008 ²⁾ | | | | | | |
| Exc. SR, RS2 | | | SM1702 | | | | | | |
| 1) Exc. 2.0, 2.3 2) | | | | | | | | | |
| 100 , 100 Avant | | | | | | | | | |
| (43, C2) | 76 - 8.82 | 666001 | 366002 | | ⏏ | | | | ⊥ ⊖ |



| MODEL FAHRZEUG MODELE | YEAR JAHR ANNEE | FRONT/VORNE/AVANT | | | REAR/HINTEN/ARRIERE | PREMIUM Twin-tube Oil | EXCEL-G Twin-tube Gas | GAS-A-JUST Mono-tube Gas |
|--|-----------------------|-----------------------------|---|--------------------------------|----------------------|--|-----------------------------|--------------------------------|
| | | PREMIUM Twin-tube Oil | EXCEL-G Twin-tube Gas | GAS-A-JUST Mono-tube Gas | | | | |
| Audi (D) | | | | | | | | |
| 100 , 100 Avant | | | | | | | | |
| (44, C3) Exc. Quattro | 9.82 - 90 | 666001 | 366002 <u>376001</u> | | 441040 | 341016▼ | | |
| | | | 915702▼ SM1710▼ 910089 | | | SM9701 | | |
| (4A, C4) Exc. Sport sus., Quattro, S4, | 12.90 - 94 | 666001 | 366002 <u>376001</u> | | 441084 ¹⁾ | 341133 ¹⁾ <u>351018¹⁾</u> | | |
| | | | 915703▼ SM5183▼ 910089 | | | 915705 ¹⁾ SM9701 | | |
| (4A, C4) ⊕ Sport sus. Exc. Quattro, S4 | 12.90 - 94 | | 366002 <u>376001</u> | | | 341133 ¹⁾ <u>351018¹⁾</u> | | |
| | | | SM5183▼ | | | SM9701 | | |
| Quattro (4A, C4) Exc. Sport sus., S4, | 10.84 - 94 | 666001 | 366002 | | | 341205 ¹⁾ | | |
| | | | 910089 ²⁾⁴⁾ SM1710 ²⁾ ▼ SM5183 ³⁾ ▼ | | | SM9701 | | |
| Quattro (4A, C4) ⊕ Sport sus. Exc. S4 | 10.84 - 94 | | 366002 | | | 341206 ¹⁾ | | |
| | | | SM1710 ²⁾ ▼ SM5183 ³⁾ ▼ | | | SM9701 | | |
| 1) Exc. 2) 10.84 - 12.90 3) 91- 94 4) Only | | | | | | | | |
| 200 , 200 Avant | | | | | | | | |
| (43, C2) | 80 - 8.83 | 666001 | 366002 | | | | | |
| | | | SM1710▼ | | | | | |
| (44, C3) Exc. Quattro | 9.83 - 90 | 666001 | 366002 <u>376001</u> | | 441040 | 341016▼ | | |
| | | | 915702▼ SM1710▼ 910089 | | | Exc. SM9701 | | |
| Quattro (44, C3) Exc. Sport sus., 2.2 Turbo | 86 - 90 | 666001 | 366002 | | | 341205 | | |
| | | | 910089 ¹⁾ SM1710▼ | | | Exc. SM9701 | | |
| Quattro (44, C3) 2.2 Turbo Incl. Sport sus. | 86 - 90 | | 366002 | | | 341206 | | |
| | | | 910089 ¹⁾ SM1710▼ | | | Exc. SM9701 | | |
| Quattro ⊕ Sport sus. (44, C3) | 86 - 90 | | 366002 | | | 341206 | | |
| | | | SM1710▼ | | | Exc. SM9701 | | |
| 1) Only | | | | | | | | |



| MODEL FAHRZEUG MODELE | YEAR JAHR ANNEE | FRONT/VORNE/AVANT | | | | REAR/HINTEN/ARRIERE | | | |
|--|-----------------------|-----------------------------|-----------------------------|--------------------------------|--|-----------------------------|-----------------------------|--------------------------------|--|
| | | PREMIUM Twin-tube Oil | EXCEL-G Twin-tube Gas | GAS-A-JUST Mono-tube Gas | | PREMIUM Twin-tube Oil | EXCEL-G Twin-tube Gas | GAS-A-JUST Mono-tube Gas | |
| Audi (D) | | | | | | | | | |
| A1 (8X1, 8XK) , A1 Sportback (8XA, 8XF) | | | | | | | | | |
| (8X_) 1.0 TFSi, 1.4 TFSi (92 kW), 1.4 TSi 1.4 TDi, 1.6 TDi (85 kW) Incl. Sport sus. Exc. , | 11.14 - 10.18 | | 339741 | | | | 343824 | | |
| | | 910154 | SM1708 | | | 915400 | SM9703 | | |
| (8X_) 1.0 TFSi, 1.4 TFSi (92 kW), 1.4 TSi 1.4 TDi, 1.6 TDi (85 kW) Exc. | 11.14 - 10.18 | | 339741 | | | | 343348 | | |
| | | 910154 | SM1708 | | | 915400 | SM9703 | | |
| (8X_) 1.2 TFSi, 1.4 TFSi (kW : 90, 103, 136) 1.6 TDi (66 kW, 77 kW), 2.0 Tdi Incl. Sport sus., Exc. 1.4 TFSi (90 kW) , | 5.10 - 4.15 | | 339741 | | | | 343824 | | |
| | | 910154 | SM1708 | | | 915400 | SM9703 | | |
| (8X_) 1.4 TFSi (90 kW) Incl. Sport sus. Exc. , | 11.11 - 4.15 | | 339741 | | | | 343824 | | |
| | | 910154 | SM1708 | | | 915400 | SM9703 | | |
| (8X_) 1.4 TFSi (90 kW) Exc. | 11.11 - 6.13 | | 339741 | | | | 343824 | | |
| | | 910154 | SM1708 | | | 915400 | SM9703 | | |
| (8X_) 1.4 TFSi (90 kW) Exc. | 7.13 - 4.15 | | 339741 | | | | 343348 | | |
| | | 910154 | SM1708 | | | 915400 | SM9703 | | |
| (8X_) 1.8 TFSi Exc. Sport sus., , | 2.15 - 10.18 | | 339741 | | | | 343824 | | |
| | | 910154 | SM1708 | | | 915400 | SM9703 | | |
| (8X_) 1.8 TFSi Sport sus. Exc. | 2.15 - 10.18 | | 3348020 | | | | 343824 | | |
| | | 910154 | SM1708 | | | 915400 | SM9703 | | |
| (8X_) 1.8 TFSi Exc. | 2.15 - 10.18 | | 339741 | | | | 343348 | | |
| | | 910154 | SM1708 | | | 915400 | SM9703 | | |
| (8X_) 2.0 TFSi (4WD) Exc. Sport sus., | 3.12 - 11.12 | | 339741 | | | | | | |
| | | 910154 | SM1708 | | | 910157 | SM9709 | | |
| (8X_) 2.0 TFSi (4WD) Sport sus. Exc. | 3.12 - 11.12 | | 3348020 | | | | | | |
| | | 910154 | SM1708 | | | 910157 | SM9709 | | |



| MODEL FAHRZEUG MODELE | YEAR JAHR ANNEE | FRONT/VORNE/AVANT | | | | REAR/HINTEN/ARRIERE | | | |
|--|-----------------------|--|-----------------------------|--|--|-----------------------------|-----------------------------|--------------------------------|--|
| | | PREMIUM Twin-tube Oil | EXCEL-G Twin-tube Gas | GAS-A-JUST Mono-tube Gas | | PREMIUM Twin-tube Oil | EXCEL-G Twin-tube Gas | GAS-A-JUST Mono-tube Gas | |
| Audi (D) | | | | | | | | | |
| A1 City Carver (GBH) | | | | | | | | | |
| | (GBH) | 7.19 - | | 3348074 ¹⁾ 3348090 ²⁾ | | | | | |
| A1 Sportback (GBA) | | | | | | | | | |
| | (GBA) | 7.18 - | | 3348074 ¹⁾ 3348090 ²⁾ | | | | | |
| <div style="display: flex; justify-content: space-around;"> <div style="text-align: center;"> <p>1)</p> <p>180 mm</p> </div> <div style="text-align: center;"> <p>2)</p> <p>170 mm</p> </div> </div> | | | | | | | | | |
| A2 (8Z0) | | | | | | | | | |
| 1.4 1.2 TDI 1.4 TDI 1.6 FSI Exc. Sport sus., | (8Z0) | 2.00 - 8.05 3.01 - 8.05 2.00 - 8.05 5.02 - 8.05 | | 334835 ¹⁾ <u>324702¹⁾</u> | | | 343328 <u>353025</u> | 552700 | |
| | | | 910084 SM1713 | | | 915400 SM9703 | | | |
| 1) Exc. 1.2 TDI | | | | | | | | | |
| A3 (8L1) | | | | | | | | | |
| 1.6, 1.8, 1.8 Turbo, 1.9 TDI Exc. Sport sus. | (8L1) | 9.96 - 7.99 | 634812 | 334812 <u>324016</u> | | | 343348 | 553206 <u>243037</u> | |
| | | | 915415 SM1708 | | | 915400 SM9704 | | | |
| 1.6, 1.8, 1.8 Turbo, 1.9 TDI Exc. Sport sus. | (8L1) | 8.99 - 4.03 | 634812 | 334812 <u>324016</u> | | | 343348 | 553206 <u>243037</u> | |
| | | | 915415 SM1708 | | | 915400 SM9704 | | | |
| ⊕ Sport sus. | (8L1) | 9.96 - 7.99 | | 334812 <u>324016</u> | | | | 553206 <u>243037</u> | |
| | | | 915415 SM1708 | | | 915400 SM9704 | | | |
| ⊕ Sport sus. | (8L1) | 8.99 - 4.03 | | 334812 <u>324016</u> | | | | 553206 <u>243037</u> | |
| | | | 915415 SM1708 | | | 915400 SM9704 | | | |



Audi

| MODEL FAHRZEUG MODELE | YEAR JAHR ANNEE | FRONT/VORNE/AVANT | | | | REAR/HINTEN/ARRIERE | | | |
|--|-----------------------|--|-----------------------------|--|--|-----------------------------|--|--------------------------------|--|
| | | PREMIUM Twin-tube Oil | EXCEL-G Twin-tube Gas | GAS-A-JUST Mono-tube Gas | | PREMIUM Twin-tube Oil | EXCEL-G Twin-tube Gas | GAS-A-JUST Mono-tube Gas | |
| Audi (D) | | | | | | | | | |
| A3 (8L1) | | | | | | | | | |
| Quattro Exc. Sport sus., S3 | (8L1) | 9.96 - 7.99 | 634812 | 334812 <u>324016</u> | | | 343310 | 553243 | |
| | | | 915415 | SM1708 | | | | | |
| Quattro Exc. Sport sus., S3 | (8L1) | 8.99 - 4.03 | | 334670 | | | | 553243 | |
| | | | 915415 | SM1708 | | | | | |
| Quattro ⊕ Sport sus. Exc. S3 | (8L1) | 9.96 - 7.99 | | 334812 <u>324016</u> | | | | 553243 | |
| | | | 915415 | SM1708 | | | | | |
| Quattro ⊕ Sport sus. Exc. S3 | (8L1) | 8.99 - 4.03 | | 334670 | | | | 553243 | |
| | | | 915415 | SM1708 | | | | | |
| Quattro ⊕ Exc. S3 | (8L1) | 9.96 - 7.99 | | 334812 | | | 344301 | | |
| | | | 915415 | SM1708 | | | | | |
| Quattro ⊕ Exc. S3 | (8L1) | 8.99 - 4.03 | | 334670 | | | 344301 | | |
| | | | 915415 | SM1708 | | | | | |
| A3 (8P1) , A3 (8P7) | | | | | | | | | |
| (2WD) 1.2 TDi, 1.2 TFSi, 1.4 TFSi 1.6 i, 1.6 FSi, 1.6 TDi, 1.6 Epower 1.8 TFSi, 1.9 TDi, 2.0 FSi, 2.0 TDi, 2.0 TFSi Exc. Sport sus., , Quattro | (8P1, 8P7) | 5.03 - 8.12 | | 334834 ¹⁾ 335808 ²⁾ <u>324703¹⁾</u> <u>325700²⁾</u> | | | 344459 <u>354006</u> | | |
| | | | 910004 | SM1714 | | | SM9707 ³⁾⁶⁾ 910002 ⁴⁾⁷⁾ SM9708 ⁴⁾⁷⁾ 910180 ⁵⁾⁷⁾ SM9709 ⁵⁾⁷⁾ | | |
| (4WD) 1.8 TFSi Quattro 2.0 TDi Quattro 2.0 TFSi Quattro 3.2 V6 Quattro Exc. Sport sus., | (8P1) | 7.08 - 8.12 5.03 - 8.12 9.04 - 8.12 7.03 - 8.12 | | 335808 ²⁾ <u>325700²⁾</u> | | | 344459 <u>354006</u> | | |
| | | | 910004 | SM1714 | | | 910002 ⁴⁾ SM9708 ⁴⁾ 910180 ⁵⁾ SM9709 ⁵⁾ | | |
| A3 Sportback (8PA) | | | | | | | | | |
| (2WD) Exc. Sport sus., , Quattro | (8PA) | 9.04 - | | 334834 ¹⁾ 335808 ²⁾ <u>324703¹⁾</u> <u>325700²⁾</u> | | | 344459 <u>354006</u> | | |
| | | | 910004 | SM1714 | | | 910002 ⁴⁾ SM9708 ⁴⁾ 910180 ⁵⁾ SM9709 ⁵⁾ | | |



| MODEL FAHRZEUG MODELE | YEAR JAHR ANNEE | FRONT/VORNE/AVANT | | | REAR/HINTEN/ARRIERE | | |
|-----------------------------|-----------------------|-----------------------------|-----------------------------|--------------------------------|-----------------------------|-----------------------------|--------------------------------|
| | | PREMIUM Twin-tube Oil | EXCEL-G Twin-tube Gas | GAS-A-JUST Mono-tube Gas | PREMIUM Twin-tube Oil | EXCEL-G Twin-tube Gas | GAS-A-JUST Mono-tube Gas |

Audi (D)

A3 Sportback (8PA)

| | | | | | | | |
|---|-------|---------------------------------------|----------------------|------|--------|--|------|
| (4WD) 1.8 TFSI Quattro 2.0 TDi Quattro 2.0 TFSI Quattro 3.2 V6 Quattro Exc. Sport sus., | (8PA) | 7.08 - 11.05 - 9.04 - 9.04 - | 335808 ²⁾ | | 344459 | | |
| | | | 325700 ²⁾ | | 354006 | | |
| | | | 910004 SM1714 | | | 910002 ⁴⁾ SM9708 ⁴⁾ 910180 ⁵⁾ SM9709 ⁵⁾ | |

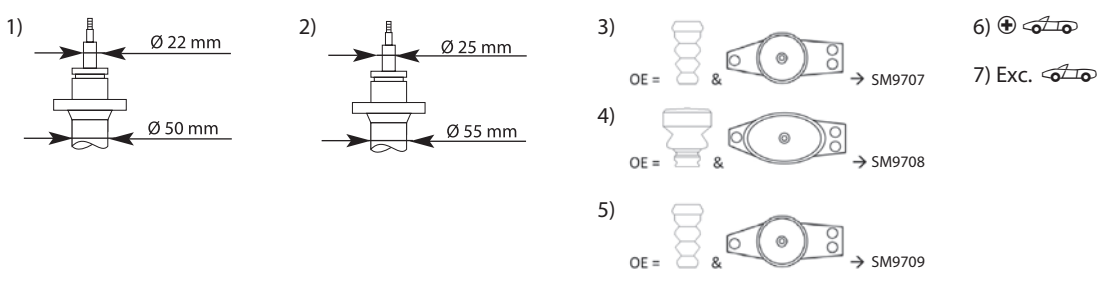

A3 (8V1, 8VK) , A3 Sportback (8VA, 8VF) , A3 Limousine (8VS, 8VM)

| | | | | | | | |
|---|-------|--------|------------------------------|------|-----------------------|--|------|
| (2WD) Incl. Sport sus., Exc. | (8V_) | 4.12 - | 3348039 ¹⁾ | | 3430023 ³⁾ | | |
| | | | 3358015 ²⁾ | | 3448024 ⁴⁾ | | |
| | | | 910255 SM1051 ⁶⁾ | | | 910256 ⁷⁾ SM9924 ⁹⁾ 910257 ⁸⁾ SM9925 ⁹⁾ | |
| (4WD) Incl. Sport sus., Exc. , RS3, S3 | (8V_) | 8.12 - | 3348039 ¹⁾ | | 3448024 ⁴⁾ | | |
| | | | 3358015 ²⁾ | | SM1051 ⁶⁾ | 910256 ⁷⁾ SM9924 ⁹⁾ 910257 ⁸⁾ SM9925 ⁹⁾ | |

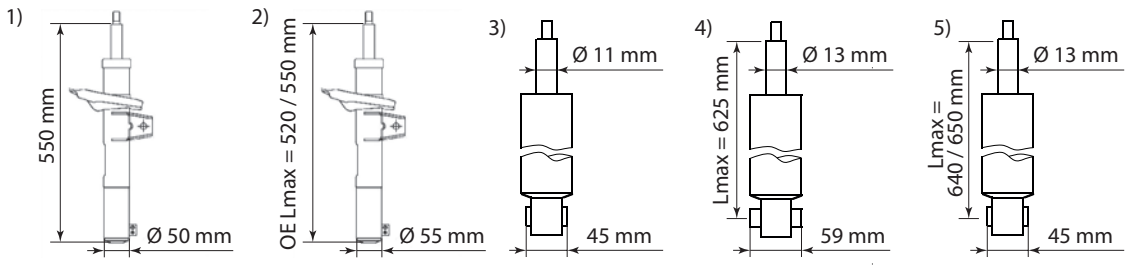

- 6) → 1.17
- 7) Normal sus.
Exc. Sport sus., , , TFSi g-tron
- 8) Sport sus.
Exc. , , TFSi g-tron
- | | | |
|------------------|--|--------------------------------------|
| SM9924 SM9925 | | Standard sus., Sport sus. (exc. CNG) |
| | | Standard sus. (CNG), , S-Line |
| | | exc. |



Audi

| MODEL FAHRZEUG MODELE | YEAR JAHR ANNEE | FRONT/VORNE/AVANT | | | REAR/HINTEN/ARRIERE | | |
|-----------------------------|-----------------------|-----------------------------|-----------------------------|--------------------------------|-----------------------------|-----------------------------|--------------------------------|
| | | PREMIUM Twin-tube Oil | EXCEL-G Twin-tube Gas | GAS-A-JUST Mono-tube Gas | PREMIUM Twin-tube Oil | EXCEL-G Twin-tube Gas | GAS-A-JUST Mono-tube Gas |

Audi (D)

A3 Cabriolet (8V7, 8VE)

| | | | | | | |
|---|--|--|----------------------|--|---|----------------------|
| (8V_) 10.13 - Exc. Sport sus., , 1.5 TFSi, S3 | | 3348039 ¹⁾ 3358015 ²⁾ | SM1051 ⁶⁾ | | | SM9925 ⁷⁾ |
| (8V_) 5.17 - 1.5 TFSi Incl. Sport sus., Exc. | | 3348039 ¹⁾ 3358015 ²⁾ | SM1051 ⁶⁾ | | 3430023 ³⁾ 3448024 ⁴⁾ 3448025 ⁵⁾ | SM9925 ⁷⁾ |

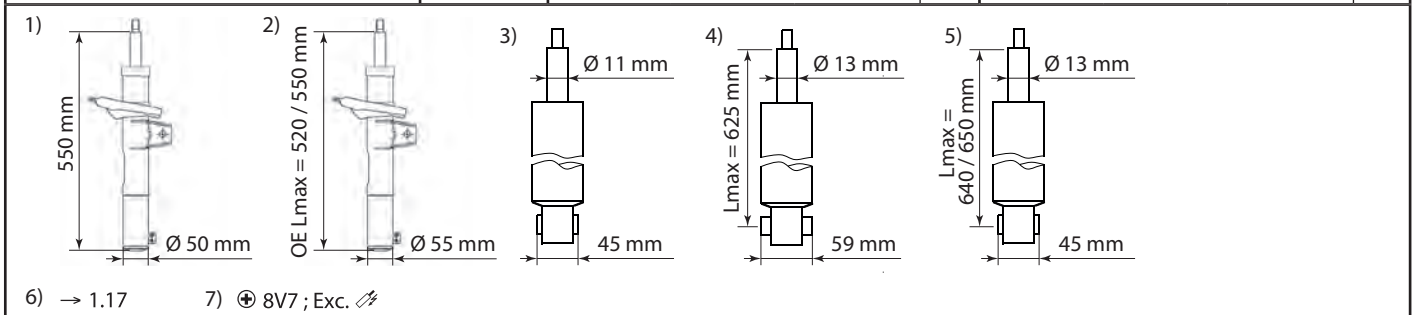

A3 Sportback (8YA)

| | | | | | | |
|--|--|--|--|--|--------|--|
| (8YA) 6.20 - 40 TFSIe, 45 TFSIe Exc. | | | | | 910332 | |
|--|--|--|--|--|--------|--|

A4 (8D2) , A4 Avant (8D5)

| | | | | | | |
|---|--|------------------|--|--|--|----------------------|
| (8D*, B5) 11.94 - 1.99 Exc. Sport sus. | | 341842 351700 | SM1711 ²⁾ ▼ SM5236 ²⁾ | | 343271 ¹⁾ 353014 ¹⁾ | SM5377 ²⁾ |
| (8D*, B5) 11.94 - 1.99 ⊕ Sport sus. | | 351700 | SM1711 ²⁾ ▼ SM5236 ²⁾ | | 343271 ¹⁾ 353014 ¹⁾ | SM5377 ²⁾ |
| (8D*, B5) 11.94 - 1.99 Exc. Sport sus., S4 | | 341842 351700 | SM1711 ²⁾ ▼ SM5236 ²⁾ | | 341909 | |
| (8D*, B5) 11.94 - 1.99 ⊕ Sport sus. Exc. S4 | | 351700 | SM1711 ²⁾ ▼ SM5236 ²⁾ | | 341909 | |

1)

| | | |
|---------------|--|----------------|
| 2) KYB | | |
| SM1711 ▼ | | → 8D-W-012335 |
| SM1712 ▼ | | 8D-W-012335 → |
| SM5236 | | |
| SM5377 | | → 8D-X-199 999 |
| ∅ | | 8D-X-200 001 → |

See pictures in section
suspension mounting type
numerical listing



| MODEL FAHRZEUG MODELE | YEAR JAHR ANNEE | FRONT/VORNE/AVANT | | | | REAR/HINTEN/ARRIERE | | | |
|--------------------------------------|-----------------------|-----------------------------|--|--------------------------------|--|--|-----------------------------|--------------------------------|--|
| | | PREMIUM Twin-tube Oil | EXCEL-G Twin-tube Gas | GAS-A-JUST Mono-tube Gas | | PREMIUM Twin-tube Oil | EXCEL-G Twin-tube Gas | GAS-A-JUST Mono-tube Gas | |
| Audi (D) | | | | | | | | | |
| A4 (8D2) , A4 Avant (8D5) | | | | | | | | | |
| (8D2, B5) Exc. Sport sus., | 2.99 - 11.00 | | 341842 351700 | | | 343302 ¹⁾ 353016 ¹⁾ ▼ | | | |
| | | 915708 | SM1712 ²⁾ ▼ SM5236 ²⁾ | | | SM5377 ²⁾ | | | |
| (8D2, B5) + Sport sus. | 2.99 - 11.00 | | 351700 | | | 343302 ¹⁾ 353016 ¹⁾ ▼ | | | |
| | | 915708 | SM1712 ²⁾ ▼ SM5236 ²⁾ | | | SM5377 ²⁾ | | | |
| (8D2, B5) Exc. Sport sus., S4 | 2.99 - 11.00 | | 341842 351700 | | | 341909 | | | |
| | | 915708 | SM1712 ²⁾ ▼ SM5236 ²⁾ | | | | | | |
| (8D2, B5) + Sport sus. Exc. S4 | 2.99 - 11.00 | | 351700 | | | 341909 | | | |
| | | 915708 | SM1712 ²⁾ ▼ SM5236 ²⁾ | | | | | | |
| (8D5, B5) Exc. Sport sus., | 2.99 - 9.01 | | 341842 351700 | | | 343302 ¹⁾ 353016 ¹⁾ ▼ | | | |
| | | 915708 | SM1712 ²⁾ ▼ SM5236 ²⁾ | | | SM5377 ²⁾ | | | |
| (8D5, B5) + Sport sus. | 2.99 - 9.01 | | 351700 | | | 343302 ¹⁾ 353016 ¹⁾ ▼ | | | |
| | | 915708 | SM1712 ²⁾ ▼ SM5236 ²⁾ | | | SM5377 ²⁾ | | | |
| (8D5, B5) Exc. Sport sus., S4 | 2.99 - 9.01 | | 341842 351700 | | | 341909 | | | |
| | | 915708 | SM1712 ²⁾ ▼ SM5236 ²⁾ | | | | | | |
| (8D5, B5) + Sport sus. Exc. S4 | 2.99 - 9.01 | | 351700 | | | 341909 | | | |
| | | 915708 | SM1712 ²⁾ ▼ SM5236 ²⁾ | | | | | | |

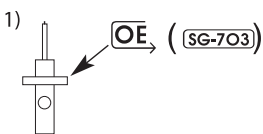

2)

| KYB | | | |
|----------|--|----------------|--|
| SM1711 ▼ | | → 8D-W-012335 | See pictures in section suspension mounting type numerical listing |
| SM1712 ▼ | | 8D-W-012335 → | |
| SM5236 | | | |
| SM5377 | | → 8D-X-199 999 | |
| ø | | 8D-X-200 001 → | |



Audi

| MODEL FAHRZEUG MODELE | YEAR JAHR ANNEE | FRONT/VORNE/AVANT | | | REAR/HINTEN/ARRIERE | | |
|-----------------------------|-----------------------|-----------------------------|-----------------------------|--------------------------------|-----------------------------|-----------------------------|--------------------------------|
| | | PREMIUM Twin-tube Oil | EXCEL-G Twin-tube Gas | GAS-A-JUST Mono-tube Gas | PREMIUM Twin-tube Oil | EXCEL-G Twin-tube Gas | GAS-A-JUST Mono-tube Gas |

Audi (D)

A4 (8E2) , A4 Avant (8E5)

| | | | | | | | | | | |
|---|-----------|---------------|--|--------|----------------|--|--|--------|----------------|--|
| ALL 2WD Exc. Sport sus., , RS4, S4 | (8E*, B6) | 11.00 - 12.04 | | 341845 | | | | 341814 | | |
| ALL 2WD Exc. Sport sus., , RS4, S4 | (8E*, B6) | 11.00 - 12.04 | | 341845 | 910116 SM5446 | | | 341814 | 910224 SM9918 | |
| ALL 2WD Exc. Sport sus., , RS4, S4 | (8E*, B6) | 11.00 - 12.04 | | 341845 | 915708 SM5446 | | | 341814 | 910225 SM9918 | |
| ALL 4WD Exc. Sport sus., , RS4, S4 | (8E*, B6) | 11.00 - 12.04 | | 341845 | 910116 SM5446 | | | 341814 | 910224 SM9918 | |
| ALL 4WD Exc. Sport sus., , RS4, S4 | (8E*, B6) | 11.00 - 12.04 | | 341845 | 915708 SM5446 | | | 341814 | 910225 SM9918 | |

A4 (8EC) , A4 Avant (8ED)

| | | | | | | | | | | |
|---|-----------|--------------|--|--------|----------------|--|--|--------|----------------|--|
| ALL 2WD Exc. Sport sus., , RS4, S4 | (8E*, B7) | 11.04 - 6.08 | | 341845 | 910116 SM5446 | | | 344807 | 910226 SM9918 | |
| ALL 2WD Exc. Sport sus., , RS4, S4 | (8E*, B7) | 11.04 - 6.08 | | | 915708 SM5446 | | | 344808 | 910227 SM9918 | |
| ALL 4WD Exc. Sport sus., , RS4, S4 | (8E*, B7) | 11.04 - 6.08 | | 341845 | 910116 | | | 344807 | 910226 SM9918 | |
| ALL 4WD Exc. Sport sus., , RS4, S4 | (8E*, B7) | 11.04 - 6.08 | | | 915708 | | | 344808 | 910227 SM9918 | |

A4 Cabriolet (8H*)

| | | | | | | | | | | |
|---------------------------------|-------------|-------------|--|--------|--------|--|--|--------|---|--|
| ALL 2WD 4WD Exc. RS4, S4 | (8H*, B6/7) | 4.02 - 3.09 | | 341845 | 915708 | | | 341814 | 910225 ¹⁾ SM9918 910227 ²⁾ | |
|---------------------------------|-------------|-------------|--|--------|--------|--|--|--------|---|--|

1) 8H7 (01 →) 2) 8HE (05 →)

A4 (8K2) , A4 Avant (8K5)

| | | | | | | | | | | |
|---|------------|---------------|--|--------|----------------|--|--|--------|----------------|--|
| ALL 2WD 4WD Exc. Sport sus., , H/D, RS4, S4, | (8K2, 8K5) | 11.07 - 12.15 | | 341717 | 910119 SM5784 | | | 344710 | 910155 SM5666 | |
| ALL 2WD 4WD Exc. Sport sus., , H/D, RS4, S4, | (8K2, 8K5) | 11.07 - 12.15 | | 341719 | 910118 SM5784 | | | 344711 | 910156 SM5666 | |



| MODEL FAHRZEUG MODELE | YEAR JAHR ANNEE | FRONT/VORNE/AVANT | | | | REAR/HINTEN/ARRIERE | | | |
|---|-----------------------|-----------------------------|-----------------------------|--------------------------------|--|-----------------------------|-----------------------------|--------------------------------|--------|
| | | PREMIUM Twin-tube Oil | EXCEL-G Twin-tube Gas | GAS-A-JUST Mono-tube Gas | | PREMIUM Twin-tube Oil | EXCEL-G Twin-tube Gas | GAS-A-JUST Mono-tube Gas | |
| Audi (D) | | | | | | | | | |
| A4 (8K2) , A4 Avant (8K5) | | | | | | | | | |
| (8K2, 8K5) 1.8 TFSi (88 kW, 125 kW) , 2.0 TDi (kW : 88, 100, 105, 120, 125) , 2.0 TDi (kW : 110, 130, 140) , 2.0 TFSi , 2.0 TFSi flexible fuel , 3.0 TDi (150 kW, 180 kW) ⊕ , H/D Exc. Sport sus., RS4, S4, | 11.07 - 12.15 | | 341738 | | | | 3448011 ¹⁾ | | |
| | | | | | | | | | |
| | | | 910119 | | | | | | SM5666 |
| (8K2, 8K5) 1.8 TFSi (118 kW) , 2.0 TDi (105 kW, 125 kW) , 2.7 TDi, 3.0 TDi (176 kW), 3.2 FSi ⊕ , H/D Exc. Sport sus., RS4, S4, | 11.07 - 12.15 | | 341738 | | | | | | |
| | | | | | | | | | |
| | | | 910119 | | | | | | SM5666 |
| 1) 1.8 TFSi (88 kW), 2.0 TDi (100 kW), 2.0 TFSi (132 kW, 155 kW), 2.0 TFSi flexible fuel : 1.12 → 2.0 TDi (88 kW) : ⊕ 2.0 TDi (105 kW) : ⊕ 2.0 TDi (120 kW) : ⊕ | | | | | | | | | |
| A4 Allroad (8KH) | | | | | | | | | |
| (8KH) | 4.09 - 5.16 | | | | | | 3448020 | | |
| | | | | | | | | | |
| | | | 910119 | | | | 910155 | | |
| A4 (8W2, 8WC) , A4 Avant (8W5, 8WD) | | | | | | | | | |
| (8W2, 8WC, 8W5, 8WD) ⊕ H/D Exc. S4, RS4, Sports sus., | 5.15 - | | 3418005 | | | | | | |
| A4 Allroad (8WH, 8WJ) | | | | | | | | | |
| (8WH, 8WJ) ⊕ H/D Exc. | 1.16 - 4.20 | | 3418005 | | | | | | |
| A5 (8T3) | | | | | | | | | |
| (8T3) Exc. Sport sus., , RS5, | 6.07 - | | 341718 | | | | 344711 | | |
| | | | | | | | | | |
| | | | 910118 | | | | 910156 | | SM5666 |
| (8T3) ⊕ Sport sus. Exc. , RS5, | 6.07 - | | 341719 | | | | 344711 | | |
| | | | | | | | | | |
| | | | | | | | 910156 | | SM5666 |
| A5 Cabriolet (8F7) | | | | | | | | | |
| (8F7) Exc. Sport sus., , RS5, | 3.09 - | | 341718 | | | | 344711 | | |
| | | | | | | | | | |
| | | | 910118 | | | | 910156 | | SM5666 |
| (8F7) ⊕ Sport sus. Exc. , RS5, | 3.09 - | | 341719 | | | | 344711 | | |
| | | | | | | | | | |
| | | | | | | | 910156 | | SM5666 |



Audi

| MODEL FAHRZEUG MODELE | YEAR JAHR ANNEE | FRONT/VORNE/AVANT | | | REAR/HINTEN/ARRIERE | | |
|-----------------------------|-----------------------|-----------------------------|-----------------------------|--------------------------------|-----------------------------|-----------------------------|--------------------------------|
| | | PREMIUM Twin-tube Oil | EXCEL-G Twin-tube Gas | GAS-A-JUST Mono-tube Gas | PREMIUM Twin-tube Oil | EXCEL-G Twin-tube Gas | GAS-A-JUST Mono-tube Gas |

Audi (D)

A5 Sportback (8TA)

| | | | | | | | |
|---|--|----------------|--|--|----------------|--|--|
| (8TA) 5.09 - Exc. Sport sus., , RS5, | | 341718 | | | 344711 | | |
| | | 910118 SM5784 | | | 910156 SM5666 | | |
| (8TA) 5.09 - Exc. , Sport sus., RS5, | | 341719 | | | 344711 | | |
| | | SM5784 | | | 910156 SM5666 | | |

A6 (4A) , A6 Avant (4A)

| | | | | | | | |
|---|--|----------------|------------------|--|--|--|--|
| (4A, C4) 6.94 - 12.97 Exc. Sport sus., | | 666001 | 366002 376001 | | 441084 ¹⁾ 341133 ¹⁾ 351018 ¹⁾ | | |
| | | 915703 SM5183 | | | 915705 SM9701 | | |
| (4A, C4) 6.94 - 12.97 Exc. Sport sus. | | | 366002 376001 | | 341133 ¹⁾ 351018 ¹⁾ | | |
| | | | SM5183 | | SM9701 | | |
| (4A, C4) 6.94 - 12.97 Exc. Sport sus., S6, | | 666001 | 366002 | | 341205 ¹⁾ | | |
| | | | SM5183 | | SM9701 | | |
| (4A, C4) 6.94 - 12.97 Exc. Sport sus. | | | 366002 | | 341206 ¹⁾ | | |
| | | | SM5183 | | SM9701 | | |

1) Exc.

A6 (4B2) , A6 Avant (4B5)

| | | | | | | | |
|---|--|--|----------------------|--|--|--|--|
| 1.8 i, 1.8 T, 1.9 TDi (4B*, C5) 97 - 2.4 i V6, 2.8 i V6, 3.0 i V6 → 4B#X#070000 Exc. Sport sus., Quattro, S6, | | | 341842 | | 343281 ¹⁾ 553207 ¹⁾ | | |
| | | | SM1712 ²⁾ | | 910003 | | |
| | | | SM5236 ²⁾ | | | | |
| 1.8 i, 1.8 T, 1.9 TDi (4B*, C5) - 2.4 i V6, 2.8 i V6, 3.0 i V6 4B#X#070000 → 4B#Y#200000 Exc. Sport sus., Quattro, S6, | | | 341843 | | 343281 ¹⁾ 553207 ¹⁾ | | |
| | | | SM1712 ²⁾ | | 910003 | | |
| | | | SM5236 ²⁾ | | | | |
| 1.8 i, 1.8 T, 1.9 TDi, 2.5 TDi (4B*, C5) - 04 2.0 i, 2.4 i V6, 2.8 i V6, 3.0 i V6 4B#1#000001 → Exc. Sport sus., Quattro, S6, | | | 341844 | | 343281 ¹⁾ 553207 ¹⁾ | | |
| | | | SM1712 ²⁾ | | 910003 SM9706 | | |
| | | | SM5236 ²⁾ | | | | |
| Sport sus. (4B*, C5) 97 - 1.8 i, 1.8 T, 1.9 TDi, 2.5 TDi 2.4 i V6, 2.7 T V6, 2.8 i V6 → 4B#Y#200000 Exc. Quattro, S6, | | | 341843 | | 553207 ¹⁾ | | |
| | | | SM1712 ²⁾ | | 910228 | | |
| | | | SM5236 ²⁾ | | | | |

1) Exc.

2)

| | | | | |
|--------|--|--|--|--|
| | | | | |
| SM1712 | | | | See pictures in section |
| SM5236 | | | | suspension mounting type numerical listing |



| MODEL FAHRZEUG MODELE | YEAR JAHR ANNEE | FRONT/VORNE/AVANT | | | | REAR/HINTEN/ARRIERE | | | | | | | | | | | | | |
|---|-----------------------|-----------------------------|-----------------------------|--|--|-----------------------------|-----------------------------|--------------------------------|--|----------|--|--|--|-------------------------|--------|--|--|--|--|
| | | PREMIUM Twin-tube Oil | EXCEL-G Twin-tube Gas | GAS-A-JUST Mono-tube Gas | | PREMIUM Twin-tube Oil | EXCEL-G Twin-tube Gas | GAS-A-JUST Mono-tube Gas | | | | | | | | | | | |
| Audi (D) | | | | | | | | | | | | | | | | | | | |
| A6 (4B2) , A6 Avant (4B5) | | | | | | | | | | | | | | | | | | | |
| ⊕ Sport sus. 1.8 i, 1.8 T, 1.9 TDi, 2.0 i, 2.4 i V6, 2.7 T V6, 2.8 i V6, 3.0 i V6, 2.5 TDi 4B#1#000001 → Exc. Quattro, S6, | (4B*, C5) - 04 | | 341844 | | | | | 553207 ¹⁾ | | | | | | | | | | | |
| | | | | SM1712 ³⁾ ▼ SM5236 ³⁾ | | 910228 | | SM9706 | | | | | | | | | | | |
| Quattro 1.8 i, 1.8 T, 1.9 TDi 2.4 i V6, 2.5 TDi, 2.8 i V6 → 4B#X#070000 Exc. Sport sus., S6, | (4B*, C5) 97 - | | 341842 | | | | | | | | | | | | | | | | |
| | | | | SM1712 ²⁾³⁾ ▼ SM5236 ²⁾³⁾ | | | | | | | | | | | | | | | |
| Quattro 1.8 i, 1.8 T, 1.9 TDi, 2.4 i V6, 2.5 TDi, 2.8 i V6 4B#X#0700011 → 4B#Y#200000 Exc. Sport sus., S6, | (4B*, C5) - | | 341843 | | | | | | | | | | | | | | | | |
| | | | | SM1712 ²⁾³⁾ ▼ SM5236 ²⁾³⁾ | | | | | | | | | | | | | | | |
| Quattro 1.8 i, 1.8 T, 1.9 TDi, 2.4 i V6, 2.5 TDi, 2.7 T V6, 2.8 i V6, 3.0 i V6 4B#1#000001 → 4B#1#200000 Exc. Sport sus., S6, | (4B, C5) - | | 341844 | | | | | | | | | | | | | | | | |
| | | | | SM1712 ²⁾³⁾ ▼ SM5236 ²⁾³⁾ | | | | | | | | | | | | | | | |
| Quattro 1.8 i, 1.8 T, 1.9 TDi, 2.0 i, 2.4 i V6, 2.5 TDi, 2.7 T V6, 2.8 i V6, 3.0 i V6 4B#2#000001 → Exc. Sport sus., S6, | (4B*, C5) - 04 | | 341844 | | | | | | | | | | | | | | | | |
| | | | | SM1712 ²⁾³⁾ ▼ SM5236 ²⁾³⁾ | | | | | | | | | | | | | | | |
| ⊕ Sport sus. 1.8 i, 1.8 T, 1.9 TDi, 2.4 i V6 2.5 TDi, 2.7 T V6, 2.8 i V6 → 4B#Y#200000 Exc. S6, | (4B*, C5) 97 - | | 341843 | | | | | | | | | | | | | | | | |
| | | | | SM1712 ³⁾ ▼ SM5236 ³⁾ | | | | | | | | | | | | | | | |
| Quattro ⊕ Sport sus. 1.8 i, 1.8 T, 1.9 TDi, 2.0 i 2.4 i V6, 2.7 T V6, 2.8 i V6, 3.0 i V6 4B#1#000001 → Exc. S6, | (4B*, C5) - 04 | | 341844 | | | | | | | | | | | | | | | | |
| | | | | SM1712 ³⁾ ▼ SM5236 ³⁾ | | | | | | | | | | | | | | | |
| ⊕ 1.8, 1.8 Turbo, 2.0, 2.4 V6 2.7 Turbo V6, 2.8 V6, 3.0 V6 1.9 TDi, 2.5 TDi 4B#1#000001 → Exc. Quattro, | (4B*, C5) - 04 | | 341301 | | | | 345027 | | | | | | | | | | | | |
| | | | | | | | | | | | | | | | | | | | |
| | | | | 915708 | | | | | | | | | | | | | | | |
| <p>1) Exc. </p> <p>2) Incl. 4.2 Quattro</p> <p>3) </p> <table border="1"> <tr> <td>SM1712 ▼</td> <td></td> <td></td> <td></td> <td>See pictures in section</td> </tr> <tr> <td>SM5236</td> <td></td> <td></td> <td></td> <td>suspension mounting type numerical listing</td> </tr> </table> | | | | | | | | | | SM1712 ▼ | | | | See pictures in section | SM5236 | | | | suspension mounting type numerical listing |
| SM1712 ▼ | | | | See pictures in section | | | | | | | | | | | | | | | |
| SM5236 | | | | suspension mounting type numerical listing | | | | | | | | | | | | | | | |



Audi

| MODEL FAHRZEUG MODELE | YEAR JAHR ANNEE | FRONT/VORNE/AVANT | | | | REAR/HINTEN/ARRIERE | | | |
|---|-----------------------|---|-----------------------------|--------------------------------|--|---------------------------------|-----------------------------|--------------------------------|--|
| | | PREMIUM Twin-tube Oil | EXCEL-G Twin-tube Gas | GAS-A-JUST Mono-tube Gas | | PREMIUM Twin-tube Oil | EXCEL-G Twin-tube Gas | GAS-A-JUST Mono-tube Gas | |
| Audi (D) | | | | | | | | | |
| A6 (4B2) , A6 Avant (4B5) | | | | | | | | | |
| Quattro (4B*, C5) 1.8, 1.8 Turbo, 2.0, 2.4 V6 2.7 Turbo V6, 2.8 V6, 3.0 V6 1.9 TDi, 2.5 TDi 4B#1#000001 → Exc. | - 04 | | 341301 | | | | | | |
| | | ☞☞☞ 915708 | | | | | | | |
| A6 (4F2) , A6 Avant (4F5) | | | | | | | | | |
| (2WD) (4F*, C6) 2.0 TFSi, 2.4, 3.0, 3.2 FSi 2.0 TDi, 2.7 TDi, 2.8 FSi Exc. Sport sus., Quattro, | 5.04 - 8.11 | | 341822 ¹⁾ | | | | 344806 | | |
| | | ☞☞☞ 910116 ²⁾ SM1552 ☞☞☞ 910185 ³⁾⁴⁾ | | | | ☞☞☞ 910226 SM9918 | | | |
| (2WD) (4F*, C6) 2.0 TFSi, 2.4, 3.0, 3.2 FSi 2.0 TDi, 2.7 TDi, 2.8 FSi Sport sus. Exc. Quattro, | 5.04 - 8.11 | | 341823 ¹⁾ | | | | 344806 | | |
| | | ☞☞☞ 915708 ²⁾ SM1552 ⁴⁾ ☞☞☞ 910184 ³⁾⁴⁾ | | | | ☞☞☞ 910227 ⁴⁾ SM9918 | | | |
| Quattro (4WD) (4F*, C6) 2.4, 2.7 TDi, 2.8 FSi, 3.0 3.0 TFSi, 3.0 TDi, 3.2 FSi, 4.2, 4.2 FSi Exc. Sport sus., S6, RS6, | 5.04 - 8.11 | | 341822 ¹⁾ | | | | 344806 | | |
| | | ☞☞☞ 910116 ²⁾ SM1552 ☞☞☞ 910185 ³⁾ | | | | ☞☞☞ 910226 SM9918 | | | |
| <p>1) 2) → 9.08 3) 10.08 → 4) Incl. </p> | | | | | | | | | |
| A6 (4G2) , A6 Avant (4G5) | | | | | | | | | |
| 1.8 TFSi (2WD), 2.0 TDi (2WD) (4G*, C7) 2.0 TFSi (2WD) (4WD), 2.0 TFSi Hybrid 2.8 FSi (2WD) Exc. Sport sus., | 11.10 - | | 341745 | | | | 344711 | | |
| | | ☞☞☞ 910258 | | | | ☞☞☞ 910155 | | | |
| 2.8 FSi (4WD) (4G*, C7) 3.0 TDi (2WD) (4WD), 3.0 TFSi (4WD) Exc. Sport sus., | 11.10 - | | 341743 | | | | 344711 | | |
| | | ☞☞☞ 910258 | | | | ☞☞☞ 910155 | | | |
| (4WD) (4G2) 2.0 TDi, 2.8 FSi, 3.0 TDi, 3.0 TFSi Exc. Sport sus., | 11.10 - 4.11 | | | | | | 3448011 | | |
| | | | | | | | | | |
| 1.8 TFSi (2WD), 2.0 TDi (2WD) (4G*, C7) 2.0 TFSi (2WD) (4WD), 2.0 TFSi Hybrid 2.8 FSi (2WD) Sport sus. | 11.10 - | | 341743 | | | | 344711 | | |
| | | | | | | ☞☞☞ 910156 | | | |
| 2.8 FSi (4WD) (4G*, C7) 3.0 TDi (2WD) (4WD), 3.0 TFSi (4WD) Sport sus. | 11.10 - | | 341744 | | | | 344711 | | |
| | | | | | | ☞☞☞ 910156 | | | |



| MODEL FAHRZEUG MODELE | YEAR JAHR ANNEE | FRONT/VORNE/AVANT | | | | REAR/HINTEN/ARRIERE | | | | | | | | | | | | | | | | | | |
|---|-----------------------|-----------------------------|-----------------------------|--|--|-----------------------------|-----------------------------|--------------------------------|--|--|--|--|--|--|----------|--|--|--|-------------------------|--------|--|--|--|--|
| | | PREMIUM Twin-tube Oil | EXCEL-G Twin-tube Gas | GAS-A-JUST Mono-tube Gas | | PREMIUM Twin-tube Oil | EXCEL-G Twin-tube Gas | GAS-A-JUST Mono-tube Gas | | | | | | | | | | | | | | | | |
| Audi (D) | | | | | | | | | | | | | | | | | | | | | | | | |
| A6 (4A2) , A6 Avant (4A5) , A6 Allroad (4AH) | | | | | | | | | | | | | | | | | | | | | | | | |
| (4WD) 55 TFSI Mild Hybrid 45 TDI Mild Hybrid (155 kW, 170 kW) 50 TDI Mild Hybrid, 55 TDI Mild Hybrid ⊕ H/D Exc. S6, Sport sus., | (4A*, C8) | 2.18 - | | 3418006 | | | | | | | | | | | | | | | | | | | | |
| A7 Sportback | | | | | | | | | | | | | | | | | | | | | | | | |
| (2WD) (4WD) (4GA, 4GF) Exc. RS7, S7 Exc. Sport sus., , H/D, | | 10.10 - | | 341743 | | | | 344711 | | | | | | | | | | | | | | | | |
| (2WD) (4WD) (4GA, 4GF) ⊕ Sport sus. Exc. RS7, , H/D, | | 10.10 - | | 341744 | | | | 344711 | | | | | | | | | | | | | | | | |
| (2WD) (4WD) (4GA, 4GF) ⊕ , H/D Exc. RS7, Sport sus., | | 10.10 - | | 341745 | | | | 910156 | | | | | | | | | | | | | | | | |
| A8 | | | | | | | | | | | | | | | | | | | | | | | | |
| Quattro (AD2, 4D8) | | 03.94 - 10.98 | | | | | | | | | | | | | | | | | | | | | | |
| | | | | | SM1712 ¹⁾ ▼ SM5236 ¹⁾ | | | | | | | | | | | | | | | | | | | |
| Incl. Quattro (AD2, 4D8) | | 10.98 - 9.02 | | | SM1712 ¹⁾ ▼ SM5236 ¹⁾ | | | | | | | | | | | | | | | | | | | |
| 1) <table border="1" style="display: inline-table; vertical-align: middle;"> <tr> <td></td> <td></td> <td></td> <td></td> <td></td> </tr> <tr> <td>SM1712 ▼</td> <td></td> <td></td> <td></td> <td>See pictures in section</td> </tr> <tr> <td>SM5236</td> <td></td> <td></td> <td></td> <td>suspension mounting type numerical listing</td> </tr> </table> | | | | | | | | | | | | | | | SM1712 ▼ | | | | See pictures in section | SM5236 | | | | suspension mounting type numerical listing |
| | | | | | | | | | | | | | | | | | | | | | | | | |
| SM1712 ▼ | | | | See pictures in section | | | | | | | | | | | | | | | | | | | | |
| SM5236 | | | | suspension mounting type numerical listing | | | | | | | | | | | | | | | | | | | | |
| Cabrio (8G) | | | | | | | | | | | | | | | | | | | | | | | | |
| (8G7, B4) | | 6.91 - 8.00 | | 365500 375008 ¹⁾ | | | | 341912 | | | | | | | | | | | | | | | | |
| | | | | SM1702 | | | | | | | | | | | | | | | | | | | | |
| 1) | | | | | | | | | | | | | | | | | | | | | | | | |
| Coupé | | | | | | | | | | | | | | | | | | | | | | | | |
| GT5E GT 1.8, 1.9, 2.0 L | | 8.83 - 9.88 8.81 - 9.88 | 665030 | 365500 375008 ¹⁾ | | | 441022 | 341003 | | | | | | | | | | | | | | | | |
| | | | 910088 | SM1702 | | | | | | | | | | | | | | | | | | | | |
| (4WD) (85) Exc. Sport sus. | | 9.84 - 9.88 | 665030 | 365500 375008 ¹⁾ | | | 666002 | 366006 | | | | | | | | | | | | | | | | |
| | | | 910088 | SM1702 | | | | | | | | | | | | | | | | | | | | |
| 1) | | | | | | | | | | | | | | | | | | | | | | | | |



Audi

| MODEL FAHRZEUG MODELE | YEAR JAHR ANNEE | FRONT/VORNE/AVANT | | | | REAR/HINTEN/ARRIERE | | | |
|--|-----------------------|-----------------------------|--------------------------------|--------------------------------|--|--|-----------------------------|--------------------------------|--|
| | | PREMIUM Twin-tube Oil | EXCEL-G Twin-tube Gas | GAS-A-JUST Mono-tube Gas | | PREMIUM Twin-tube Oil | EXCEL-G Twin-tube Gas | GAS-A-JUST Mono-tube Gas | |
| Audi (D) | | | | | | | | | |
| Coupé | | | | | | | | | |
| (2WD) Incl. Sport sus. | (89) | 10.88 - 12.96 | 365500 375008 ¹⁾ | | | 341153 | | | |
| | | | 910088 SM1702 | | | | | | |
| (4WD) Exc. S2 | (89) | 10.88 - 12.96 | 365500 375008 ¹⁾ | | | 366008 | | | |
| | | | 910088 SM1702 | | | | | | |
| 1) | | | | | | | | | |
| Q2 | | | | | | | | | |
| (GAB, GAG) Incl. Sport sus. Exc. | | 6.16 - | 3358015 | | | 3448027 | | | |
| | | | SM1051 | | | | | | |
| (GAB, GAG) Incl. Sport sus. Exc. | | 7.16 - | 3358015 | | | 3448023 | | | |
| | | | SM1051 | | | | | | |
| Q3 | | | | | | | | | |
| Incl. Sport sus. Exc. | (8U) | 6.11 - | 335808 325700 | | | 349067 ¹⁾ 349235 ²⁾ | | | |
| | | | 910219 SM1714 | | | 910056 ³⁾ SM9709 ³⁾ | | | |
| 1) Incl. Sport sus. OE p/n : 5N0513049AG, 5N0513049AH, 5N0513049AJ, 5N0513049AK | | | | | | | | | |
| 2) Exc. Sport sus. OE p/n : 5ND513049D, 5ND513049E | | | | | | | | | |
| 3) Exc. Sport sus., RS | | | | | | | | | |
| Q3 (F3B), Q3 Sportback (F3N) | | | | | | | | | |
| Incl. Sport sus. Exc. TFSi e, | (F3B, F3N) | 7.18 - | 3358020 | | | 3448024 | | | |
| | | | | | | 910332 ¹⁾²⁾ | | | |
| 1) Bumper height : 127 mm 2) Q3 (F3B) : [With] 35 TFSI, 35 TFSI Mild Hybrid Q3 Sportback (F3N) : [With] 35 TFSI, 35 TFSI Mild Hybrid, 35 TDI | | | | | | | | | |
| Q5 (8RB) | | | | | | | | | |
| 2.0 TFSI, 2.0 TFSI Hybrid 3.0 TFSI, 3.0 SQ5 TFSI, 3.2 FSI 2.0 TDI, 3.0 TDI 3.0 SQ5 TDI (240 kW, 250 kW) Incl. Sport sus. Exc. | (8RB) | 11.08 - 5.17 | 345622▼ 341720 | | | 344712 | | | |
| | | | 910117 SM5784 | | | 910155 ¹⁾ SM5666 | | | |
| 1) Exc. 2.0 TFSi Quattro (162 kW, 169 kW), SQ5 TFSi Quattro, 2.0 TDi Quattro (110 kW, 140 kW), 3.0 TDi Quattro (184 kW, 190 kW), SQ5 TDi Quattro | | | | | | | | | |



| MODEL FAHRZEUG MODELE | YEAR JAHR ANNEE | FRONT/VORNE/AVANT | | | | REAR/HINTEN/ARRIERE | | | | | | | | | | | | | | | |
|--|-----------------------|-----------------------------|--|--|--|-----------------------------|-----------------------------|--------------------------------|--|--|--|--|--|----------|--|--|-------------------------|--------|--|--|--|
| | | PREMIUM Twin-tube Oil | EXCEL-G Twin-tube Gas | GAS-A-JUST Mono-tube Gas | | PREMIUM Twin-tube Oil | EXCEL-G Twin-tube Gas | GAS-A-JUST Mono-tube Gas | | | | | | | | | | | | | |
| Audi (D) | | | | | | | | | | | | | | | | | | | | | |
| Q5 (8RB) | | | | | | | | | | | | | | | | | | | | | |
| 2.0 TDI (2WD) (8RB) 3.0 SQ5 TDI (4WD) (230 kW) Incl. Sport sus. Exc. | 11.10 - 5.17 | | | | | 344712 | | | | | | | | | | | | | | | |
| | | 910117 | SM5784 | | | 910155 ¹⁾ | SM5666 | | | | | | | | | | | | | | |
| 1) Exc. 2.0 TFSi Quattro (162 kW, 169 kW), SQ5 TFSi Quattro, 2.0 TDI Quattro (110 kW, 140 kW), 3.0 TDI Quattro (184 kW, 190 kW), SQ5 TDI Quattro | | | | | | | | | | | | | | | | | | | | | |
| Q5, Q5 Sportback (FY_) | | | | | | | | | | | | | | | | | | | | | |
| (2WD) (4WD) | (FY_) 6.16 - | | 3418006 | | | 3418007 | | | | | | | | | | | | | | | |
| Incl. Hybrid, SQ5, Sport sus. Exc. | | | | | | | | | | | | | | | | | | | | | |
| Q7 | | | | | | | | | | | | | | | | | | | | | |
| | (4MB, 4MG) 1.15 - | | 3318000 | | | | | | | | | | | | | | | | | | |
| Incl. SQ7 Exc. S Line | | | | | | | | | | | | | | | | | | | | | |
| RS3 Sportback (8VA) | | | | | | | | | | | | | | | | | | | | | |
| | (8VA) 3.15 - | | | | | | SM9925 | | | | | | | | | | | | | | |
| Exc. | | | | | | | | | | | | | | | | | | | | | |
| RS4 | | | | | | | | | | | | | | | | | | | | | |
| 2.7 i Quattro 2.8 i Quattro | 6.00 - 9.01 | | | | | | | | | | | | | | | | | | | | |
| | | | | SM1712 ¹⁾ ▼ SM5236 ¹⁾ | | | | | | | | | | | | | | | | | |
| 1) <table border="1"> <tr> <td></td> <td></td> <td></td> <td></td> </tr> <tr> <td>SM1712 ▼</td> <td></td> <td></td> <td>See pictures in section</td> </tr> <tr> <td>SM5236</td> <td></td> <td></td> <td>suspension mounting type numerical listing</td> </tr> </table> | | | | | | | | | | | | | | SM1712 ▼ | | | See pictures in section | SM5236 | | | suspension mounting type numerical listing |
| | | | | | | | | | | | | | | | | | | | | | |
| SM1712 ▼ | | | See pictures in section | | | | | | | | | | | | | | | | | | |
| SM5236 | | | suspension mounting type numerical listing | | | | | | | | | | | | | | | | | | |
| RS5 | | | | | | | | | | | | | | | | | | | | | |
| | (8T3) 3.10 - | | | | | | 910156 | | | | | | | | | | | | | | |
| | | 910118 | | | | | | | | | | | | | | | | | | | |
| RS6 | | | | | | | | | | | | | | | | | | | | | |
| RS6, RS6 plus | (4F*, C6) 7.02 - 9.04 | | | | | | | | | | | | | | | | | | | | |
| | | | | SM1712 ¹⁾ ▼ SM5236 ¹⁾ | | | | | | | | | | | | | | | | | |
| RS6 | (4F*, C6) 4.08 - 8.10 | | | SM1552 | | | | | | | | | | | | | | | | | |
| 1) <table border="1"> <tr> <td></td> <td></td> <td></td> <td></td> </tr> <tr> <td>SM1712 ▼</td> <td></td> <td></td> <td>See pictures in section</td> </tr> <tr> <td>SM5236</td> <td></td> <td></td> <td>suspension mounting type numerical listing</td> </tr> </table> | | | | | | | | | | | | | | SM1712 ▼ | | | See pictures in section | SM5236 | | | suspension mounting type numerical listing |
| | | | | | | | | | | | | | | | | | | | | | |
| SM1712 ▼ | | | See pictures in section | | | | | | | | | | | | | | | | | | |
| SM5236 | | | suspension mounting type numerical listing | | | | | | | | | | | | | | | | | | |
| S2 | | | | | | | | | | | | | | | | | | | | | |
| | (89) 9.90 - 12.96 | | | | | | 366008 | | | | | | | | | | | | | | |
| | | | | | | | | | | | | | | | | | | | | | |



Audi

| MODEL FAHRZEUG MODELE | YEAR JAHR ANNEE | FRONT/VORNE/AVANT | | | REAR/HINTEN/ARRIERE | | | | | | | | | | | | | | | | |
|------------------------------------|-------------------------------------|---|--|--------------------------------|-----------------------------|-----------------------------|--------------------------------|--|--|--------------------------------------|--|--------|---------------------------|--|--|--------|--|--|--------|--|--|
| | | PREMIUM Twin-tube Oil | EXCEL-G Twin-tube Gas | GAS-A-JUST Mono-tube Gas | PREMIUM Twin-tube Oil | EXCEL-G Twin-tube Gas | GAS-A-JUST Mono-tube Gas | | | | | | | | | | | | | | |
| Audi (D) | | | | | | | | | | | | | | | | | | | | | |
| S3 (8L_) | | | | | | | | | | | | | | | | | | | | | |
| 1.8 i | 11.98 - 6.03 | | | | | | | | | | | | | | | | | | | | |
| | | | | | | | | | | | | | | | | | | | | | |
| S3 (8P_) | | | | | | | | | | | | | | | | | | | | | |
| (8P1, 8PA) | 6.08 - 3.13 | | | | | | | | | | | | | | | | | | | | |
| | | | | | | | | | | | | | | | | | | | | | |
| 1) & → SM9708 | 2) & → SM9709 | | | | | | | | | | | | | | | | | | | | |
| S3 (8V_) | | | | | | | | | | | | | | | | | | | | | |
| (8V_) Incl. Sport sus., Exc. | 11.12 - | | | | | | | | | | | | | | | | | | | | |
| | | | | | | | | | | | | | | | | | | | | | |
| (8V_) Exc. Sport sus., | 3.14 - | | | | | | | | | | | | | | | | | | | | |
| | | | | | | | | | | | | | | | | | | | | | |
| 1) 550 mm, Ø 50 mm | 2) OE Lmax = 520 / 550 mm, Ø 55 mm | 3) Lmax = 625 mm, Ø 13 mm, 59 mm | 4) Exc. Sport sus., | | | | | | | | | | | | | | | | | | |
| | | | 5) → 1.17 | | | | | | | | | | | | | | | | | | |
| | | | 6) : | | | | | | | | | | | | | | | | | | |
| | | | <table border="1"> <tr> <td></td> <td></td> <td>Standard sus., Sport sus. (exc. CNG)</td> </tr> <tr> <td></td> <td></td> <td>Standard sus. (, , S-Line</td> </tr> <tr> <td></td> <td></td> <td>exc. </td> </tr> </table> | | | | | | | Standard sus., Sport sus. (exc. CNG) | | | Standard sus. (, , S-Line | | | exc. | | | | | |
| | | Standard sus., Sport sus. (exc. CNG) | | | | | | | | | | | | | | | | | | | |
| | | Standard sus. (, , S-Line | | | | | | | | | | | | | | | | | | | |
| | | exc. | | | | | | | | | | | | | | | | | | | |
| | | | : 8V7 ; Exc. | | | | | | | | | | | | | | | | | | |
| S4 | | | | | | | | | | | | | | | | | | | | | |
| (4A, C4) Sport sus. | 8.91 - 6.94 | | | | | | | | | | | | | | | | | | | | |
| | | | | | | | | | | | | | | | | | | | | | |
| 2.7 i Quattro | 10.97 - 1.99 | | | | | | | | | | | | | | | | | | | | |
| | | | | | | | | | | | | | | | | | | | | | |
| | | | | | | | | | | | | | | | | | | | | | |
| 2.7 i Quattro | 2.99 - 9.01 | | | | | | | | | | | | | | | | | | | | |
| | | | | | | | | | | | | | | | | | | | | | |
| | | | | | | | | | | | | | | | | | | | | | |
| (8K2, 8K5) Exc. Sport sus., | 11.07 - | | | | | | | | | | | | | | | | | | | | |
| | | | | | | | | | | | | | | | | | | | | | |
| 1) | 2) Exc. | <table border="1"> <tr> <td></td> <td></td> <td></td> <td></td> </tr> <tr> <td>SM1711 </td> <td></td> <td></td> <td rowspan="3">See pictures in section suspension mounting type numerical listing</td> </tr> <tr> <td>SM1712 </td> <td></td> <td></td> </tr> <tr> <td>SM5236</td> <td></td> <td></td> </tr> </table> | | | | | | | | | | SM1711 | | | See pictures in section suspension mounting type numerical listing | SM1712 | | | SM5236 | | |
| | | | | | | | | | | | | | | | | | | | | | |
| SM1711 | | | See pictures in section suspension mounting type numerical listing | | | | | | | | | | | | | | | | | | |
| SM1712 | | | | | | | | | | | | | | | | | | | | | |
| SM5236 | | | | | | | | | | | | | | | | | | | | | |



| MODEL FAHRZEUG MODELE | YEAR JAHR ANNEE | FRONT/VORNE/AVANT | | | | REAR/HINTEN/ARRIERE | | | |
|--|-----------------------|-----------------------------|--|--------------------------------|--|-----------------------------|--|--------------------------------|--|
| | | PREMIUM Twin-tube Oil | EXCEL-G Twin-tube Gas | GAS-A-JUST Mono-tube Gas | | PREMIUM Twin-tube Oil | EXCEL-G Twin-tube Gas | GAS-A-JUST Mono-tube Gas | |
| Audi (D) | | | | | | | | | |
| S4 | | | | | | | | | |
| (8K2, 8K5) ⊕ Sport sus. Exc. | 11.07 - | | 341719 | | | | 344711 | | |
| | | ☰ 910118 | | | | ☰ 910156 | | | |
| (8K2, 8K5) ⊕ Exc. Sport sus., | 11.08 - 12.15 | | 341738 | | | | 3448011 ¹⁾ | | |
| (8W2, 8WC, 8W5, 8WD) ⊕ H/D Exc. Sport sus., | 5.16 - | | 3418005 | | | | | | |
| 1) ⊕ CGWC, CGXC | | | | | | | | | |
| S5 | | | | | | | | | |
| (8T3) Exc. | 6.07 - | | 341718 ¹⁾ 341719 ²⁾ | | | | 344710 ¹⁾ 344711 ²⁾ | | |
| | | ☰ 910118 ¹⁾ | | | | ☰ 910156 | | | |
| (8TA) Exc. | 5.09 - | | 341717 ¹⁾ 341719 ²⁾ | | | | 344710 ¹⁾ 344711 ²⁾ | | |
| | | ☰ 910118 ¹⁾ | | | | ☰ 910156 | | | |
| (8F7) Incl. Sport sus. Exc. | 6.09 - | | | | | | 344711 | | |
| | | | | | | | | | |
| 1) Exc. Sport sus. 2) ⊕ Sport sus. | | | | | | | | | |
| S6 | | | | | | | | | |
| (4A, C4) ⊕ Sport sus. | 6.94 - 10.97 | | 376001 | | | | 351020 ¹⁾ | | |
| | | | | | | | | | |
| | 9.00 - 1.05 | | | | | | | | |
| | | | | | | | | | |
| | | | | | | | | | |
| (4G*, C7) Exc. Sport sus., | 11.10 - | | | | | | ☰ 910155 | | |
| (4G*, C7) ⊕ Sport sus. Exc. | 11.10 - | | 341744 | | | | | | |
| | | | | | | ☰ 910156 | | | |
| (4A*, C8) 3.0 TDI Mild Hybrid (257 kW) ⊕ H/D Exc. Sport sus., | 3.19 - | | 3418006 | | | | | | |
| 1) Exc. | | | | | | | | | |
| 2) See pictures in section suspension mounting type numerical listing | | | | | | | | | |



| MODEL FAHRZEUG MODELE | YEAR JAHR ANNEE | FRONT/VORNE/AVANT | | | | REAR/HINTEN/ARRIERE | | | |
|--|-----------------------|-----------------------------|-----------------------------|--|--|-----------------------------|-----------------------------|--------------------------------|--|
| | | PREMIUM Twin-tube Oil | EXCEL-G Twin-tube Gas | GAS-A-JUST Mono-tube Gas | | PREMIUM Twin-tube Oil | EXCEL-G Twin-tube Gas | GAS-A-JUST Mono-tube Gas | |
| Audi (D) | | | | | | | | | |
| S7 Sportback | | | | | | | | | |
| (4GA, 4GF) + Sport sus. Exc. , H/D, | (4GA, 4GF) | 2.12 - | | 341744 | | | | | |
| (4GA, 4GF) + , H/D Exc. Sport sus., | (4GA, 4GF) | 2.12 - | | 341745 | | | | | |
| S8 | | | | | | | | | |
| S8 Quattro | (AD2, 4D8) | 7.96 - 9.02 | | | | | | | |
| | | | | SM1712 ¹⁾ SM5236 ¹⁾ | | | | | |
| 1) SM1712 SM5236 See pictures in section suspension mounting type numerical listing | | | | | | | | | |
| TT Coupé (8N3) | | | | | | | | | |
| 1.8 T Exc. Sport sus. | (8N3) | 10.98 - 9.06 | | | | | | 553206 | |
| | | | | SM1708 | | | SM9704 | | |
| 1.8 T Quattro Exc. Sport sus. | (8N3) | 10.98 - 9.06 | | | | | | 553243 | |
| | | | | SM1708 | | | | | |
| + Sport sus. | (8N3) | 10.98 - 6.06 | | | | | | | |
| | | | | 910154 | | | | | |
| TT Coupé (8J3) | | | | | | | | | |
| 1.8 TFSi , 2.0 TFSi , (8J3) 2.0 S , 2.0 TDi , 3.2 V6 Exc. Sport sus. | | 10.06 - | | 335813 | | | 349048 | | |
| | | | | 910183 SM1714 ¹⁾ | | | SM9709 ¹⁾ | | |
| 1) Incl. 2.5 TFSi RS | | | | | | | | | |
| TT Coupé (FV3) | | | | | | | | | |
| 1.8 TFSi, 2.0 TFSi (169 kW) 40 TFSi, 45 TFSi, 2.0 TTS 2.0 TDi Incl. Sport sus. Exc. , RS | (FV3) | 7.14 - | | 3358021 | | | 3448024 | | |
| | | | | | | | SM9925 | | |
| TT Roadster (8N9) | | | | | | | | | |
| 1.8 T Exc. Sport sus. | (8N9) | 10.98 - 3.07 | | | | | 343348 | 553206 | |
| | | | | SM1708 | | | SM9704 | | |
| 1.8 T Exc. Sport sus. | (8N9) | 10.98 - 3.07 | | | | | | 553243 | |
| | | | | SM1708 ¹⁾ | | | | | |
| + Sport sus. | (8N9) | 10.99 - 6.06 | | | | | | | |
| | | | | 910154 | | | | | |
| 1) Incl. 3.2 VR6 | | | | | | | | | |



| MODEL FAHRZEUG MODELE | YEAR JAHR ANNEE | FRONT/VORNE/AVANT | | | | REAR/HINTEN/ARRIERE | | | |
|---|--|-----------------------------|-----------------------------|--------------------------------|--|-----------------------------|-----------------------------|--------------------------------|--|
| | | PREMIUM Twin-tube Oil | EXCEL-G Twin-tube Gas | GAS-A-JUST Mono-tube Gas | | PREMIUM Twin-tube Oil | EXCEL-G Twin-tube Gas | GAS-A-JUST Mono-tube Gas | |
| Audi (D) | | | | | | | | | |
| TT Roadster (8J9) | | | | | | | | | |
| 1.8 TFSi (2WD), 2.0 TFSi (2WD) (4WD), (8J9) 2.0 TDi (4WD), 2.0 S (4WD), 3.2 V6 (4WD) Exc. Sport sus. | 3.07 - | | 335813 | | | | 349048 | | |
| | | 910183 | SM1714 ¹⁾ | | | | SM9709 ¹⁾ | | |
| 1) Incl. 2.5 TFSi RS (4WD) | | | | | | | | | |
| TT Roadster (FV9) | | | | | | | | | |
| (2WD) (4WD) (FV9) 1.8 TFSi, 2.0 TFSi (169 kW) 40 TFSi, 45 TFSi, 2.0 TTS 2.0 TDi Incl. Sport sus. Exc. , RS | 11.14 - | | 3358021 | | | | 3448024 | | |
| | | | | | | | SM9925 | | |
| V8 | | | | | | | | | |
| 3.6 V8 4.2 V8 | 88 - 94 91 - 94 | | 366002 | | | | 341206 | | |
| | | | SM5183▼ | | | | Exc. | | |
| Austin-Rover Group (GB) | | | | | | | | | |
| Austin, Morris | | | | | | | | | |
| Seven 850, Cooper (S) Mini Car 850, 1000, 1275 GT Mini Clubman Mini-Minor Mini-Cooper Hornet 1000 Mayfair Sport 1000 Mayfair 1100 Special | 59 - 74 76 - 76 - 59 - 76 61 - 64 62 - 64 1.70 - 1.70 - 1.70 - | 442001 | 342001 | 552018 | | 442002 | 342002 | 552019 | |
| Seven 850 Van, Countryman, Pick-up Mini Clubman Estate Mini Countryman Van, Pick-up | 59 - 76 76 - 61 - 69 | 442001 | 342001 | 552018 | | | | | |
| Mini Metro Incl. | 80 - | | 342016 | | | | | | |
| Mini (Denovo tires) [12"] | 5.76 - | 442001 | 342001 | 552018 | | | | | |



Auto Bianchi

| MODEL FAHRZEUG MODELE | YEAR JAHR ANNEE | FRONT/VORNE/AVANT | | | | REAR/HINTEN/ARRIERE | | | |
|-----------------------------|-----------------------|-----------------------------|-----------------------------|--------------------------------|--|-----------------------------|-----------------------------|--------------------------------|--|
| | | PREMIUM Twin-tube Oil | EXCEL-G Twin-tube Gas | GAS-A-JUST Mono-tube Gas | | PREMIUM Twin-tube Oil | EXCEL-G Twin-tube Gas | GAS-A-JUST Mono-tube Gas | |

Austin-Rover Group (GB)

Triumph

| | | | | | | | | | |
|---|--|--|--------|--|--|--|--|--------|--|
| Spitfire Mk IV | 70 - 8.80 | | | | | | | 552016 | |
| 2000 MK I, II Incl. 2.5 P1 2500 TC, S Stag | 63 - 75 68 - 75 74 - 77 70 - 77 | | 365048 | | | | | 554017 | |
| TR 7 TR 8 | 5.76 - 80 80 - 83 | | 363015 | | | | | 554017 | |
| Acclaim | 10.81 - 7.84 | | 333021 | | | | | | |

Auto Bianchi (I)

Bianchina

| | | | | | | | | | |
|------------------------------------|--------------------|--------|---------|--|--|--------|--|--|--|
| Bianchina Bianchina Giardiniera | 57 - 67 68 - 74 | 443005 | 343070▼ | | | 443006 | | | |
|------------------------------------|--------------------|--------|---------|--|--|--------|--|--|--|

Y 10

| | | | | | | | | | |
|-----------------------------|-----------|--------|----------------------|--|--|--------|--------|--|--|
| 1000, 1050, 1300, Turbo | 3.85 - 93 | | 331604 L 331603 R | | | 441077 | 341209 | | |
| | | 913105 | | | | | | | |
| 1000, 1100 | 3.85 - 93 | | 331604 L 331603 R | | | 441094 | 341210 | | |
| | | 913105 | | | | | | | |
| 1000, 1050, 1300, Turbo | 93 - 96 | | 331604 L 331603 R | | | | 341187 | | |
| | | 913105 | | | | | | | |
| 1000, 1100 | 93 - 96 | | 331604 L 331603 R | | | | | | |
| | | 913105 | | | | | | | |



| MODEL FAHRZEUG MODELE | YEAR JAHR ANNEE | FRONT/VORNE/AVANT | | | | REAR/HINTEN/ARRIERE | | | |
|------------------------------------|-----------------------|-----------------------------|-----------------------------|--------------------------------|--|-----------------------------|-----------------------------|--------------------------------|--|
| | | PREMIUM Twin-tube Oil | EXCEL-G Twin-tube Gas | GAS-A-JUST Mono-tube Gas | | PREMIUM Twin-tube Oil | EXCEL-G Twin-tube Gas | GAS-A-JUST Mono-tube Gas | |
| Bedford (GB) | | | | | | | | | |
| Astra, Chevanne, Rascal Van | | | | | | | | | |
| Astra (9 TC, TD 70) | 82 - 91 | 665036 | 365501 | | | 443135 | 343099 | 553137▼ | |
| Astra | 91 - 97 | 665501 | 365504 | | | 443135 | 343099 | 553137▼ | |
| | | | | SM1303 | | | | | |
| Astra Max (9 TC, TD 25) | 9.85 - 93 | 665036 | 365501 | | | 443233 | 343227 | | |
| Chevanne 9 cwt | 76 - 82 | 443026 | 343048▼ | | | 443025 | | | |
| Rascal Van | 86 - 6.90 | | | | | 442028 | | | |
| CF series | | | | | | | | | |
| CF 14, 18, 22, 25, 35 cwt | 10.69 - 76 | H/D 445010 | | | | H/D 445011 | | | |
| CF 220, 250, 280 | 1.76 - 82 | 445010 | | | | 445011 | | | |
| CF 230, 250, 280 | 83 - | 445010 | | | | | | | |
| | | | | OE = 91095938 | | | | | |
| CF 340 | 1.76 - | 445010 | | | | 445011 | | | |
| CF 350 | 1.76 - | 445010 | | | | 445011 | | | |
| CF2 35 cwt (035) | 83 - 2.84 | 445010 | | | | 445011 | | | |
| CF 18, 22, 25 cwt | 2.84 - | 445010 | | | | 445011 | | | |
| | | | | OE = 91095938 | | | | | |
| CF Electric | | 445010 | | | | | | | |
| CF 97370, CF 97170 | 8.69 - 10.87 | 445010 | | | | | | | |
| | | | | OE = 91095938 | | | | | |
| CF 97 K 60, CF 97760 | 8.69 - 10.87 | 445010 | | | | 445011 | | | |
| | | | | OE = 91095938 | | | | | |



BMW

| MODEL FAHRZEUG MODELE | YEAR JAHR ANNEE | FRONT/VORNE/AVANT | | | | REAR/HINTEN/ARRIERE | | | |
|---|------------------------|------------------------------|-----------------------------|--------------------------------|--|---|-----------------------------|--------------------------------|--|
| | | PREMIUM Twin-tube Oil | EXCEL-G Twin-tube Gas | GAS-A-JUST Mono-tube Gas | | PREMIUM Twin-tube Oil | EXCEL-G Twin-tube Gas | GAS-A-JUST Mono-tube Gas | |
| Bedford (GB) | | | | | | | | | |
| Fargo / Midi / Seta | | | | | | | | | |
| (WFR series) | 85 - 88 | 444065 | | | | 444040 | | | |
| (9800 series) | 88 - | 444065 | | | | 444040 | | | |
| (9400 series) | 88 - | | | | | 444025 | | | |
| KB series | | | | | | | | | |
| KB 25/26 (95 G 25, 95 G, D26) | 80 - | 443190 | | 553119 | | 443186 | | 553108 | |
| KB 41 (95 G, D 41) | 82 - | 443188 | | 553087 | | 443186 | | 553108 | |
| BMW (D) | | | | | | | | | |
| 1 Series (E81,E87) Exc. M-Technik sus. | | | | | | | | | |
| 116i, 118i, 120i, 130i 116d, 118d, 120d, 123d Exc. Sport sus. | (E81, E87) 9.04 - 9.12 | | 334626 L 334625 R | | | 349041 | | | |
| | | 910084 SM1003 | | | | 910193 ¹⁾ SM9008▼ 910172 ²⁾ SM5752 910194 ³⁾ | | | |
| 1) E81 : → 12.2007 2) E81 : 12.2007 → 3) E81, E87 : Sport sus. E87 : exc. Sport sus. | | | | | | | | | |
| 1 Series (E82) Exc. M-Technik sus. | | | | | | | | | |
| 120i, 125i, 135i 118d, 120d, 123d Exc. Sport sus. | (E82) 10.06 - | | 334626 L 334625 R | | | 349041 | | | |
| | | 910084 SM1003 ¹⁾ | | | | 910172 SM9008 ¹⁾ ▼ 910193 ²⁾ SM5752 ¹⁾ | | | |
| 1) Incl. M (250 kW) 2) M-technik sus. | | | | | | | | | |
| 1 Series (E88) Exc. M-Technik sus. | | | | | | | | | |
| 118i, 120i, 125i, 135i 118d, 120d, 123d Exc. Sport sus. | (E88) 3.08 - | | 334626 L 334625 R | | | 349041 | | | |
| | | 910084 SM1003 | | | | 910172 SM9008▼ SM5752 | | | |
| 1 Series (F21, F20) Exc. M-Technik sus. | | | | | | | | | |
| (F21, F20) 114d, 116d, 118d, 120d, 125d 114i, 116i, 118i, 120i, 125i Exc. M models, Sport sus., Exc. Adaptive sus., M Performance | 11.10 - | | 3348027 | | | 3448017 | | | |
| | | 910231 | | | | 910234 SM9926 ¹⁾ | | | |
| 1) incl. Sport sus., , M-Technik sus., Adaptive sus., M Performance | | | | | | | | | |



| MODEL FAHRZEUG MODELE | YEAR JAHR ANNEE | FRONT/VORNE/AVANT | | | | REAR/HINTEN/ARRIERE | | | |
|--|--------------------------------------|-----------------------------|-----------------------------|--------------------------------|--|-----------------------------|-----------------------------|--------------------------------|--|
| | | PREMIUM Twin-tube Oil | EXCEL-G Twin-tube Gas | GAS-A-JUST Mono-tube Gas | | PREMIUM Twin-tube Oil | EXCEL-G Twin-tube Gas | GAS-A-JUST Mono-tube Gas | |
| BMW (D) | | | | | | | | | |
| 1 Series (F21, F20) Exc. M-Technik sus. | | | | | | | | | |
| (2WD) M 135i (235 kW) M 135i (240 kW) Exc. Adaptive sus., M Performance | (F21, F20) 11.11 - 3.15 - 6.15 | | 3348028 | | | | 3448018 | | |
| (2WD) M 135i (240 kW) Exc. Adaptive sus., M Performance | (F21, F20) 7.15 - | | 3348027 | | | | 3448018 | | |
| (4WD) 118d, 120d Exc. M models, Sport sus., Exc. Adaptive sus., M Performance | (F20) 1.11 - | | 3348044 L 3348043 R | | | | 3448017 | | |
| | | | 910231 | | | | 910234 | | |
| (4WD) 118d (105 kW) 120d (135 kW, 147 kW) Exc. M models, Sport sus., Exc. Adaptive sus., M Performance | (F21) 1.12 - | | 3348044 L 3348043 R | | | | 3448017 | | |
| | | | 910231 | | | | 910234 | | |
| (4WD) 118d (110 kW) 120d (140 kW) Exc. M models, Sport sus., Exc. Adaptive sus., M Performance | (F21) 1.12 - | | | | | | 3448017 | | |
| | | | 910231 | | | | 910234 | | |
| (4WD) M 135i (235 kW) M 140i Exc. Adaptive sus., M Performance | (F21, F20) 2.12 - 2.15 9.15 - | | 3348046 L 3348045 R | | | | 3448018 | | |
| (4WD) M 135i (235 kW) M 135i (240 kW) Exc. Adaptive sus., M Performance | (F21, F20) 3.15 - 3.15 - 6.15 | | 3348046 L 3348045 R | | | | | | |
| (2WD) (4WD) ⊕ Sport sus. Exc. M models, Adaptive sus., M Performance | (F21, F20) 11.10 - | | | | | | | | |
| | | | | | | | 910235 | | |
| 1) incl. Sport sus., , M-Technik sus., Adaptive sus., M Performance | | | | | | | | | |
| 1 Series (F21, F20) ⊕ M-Technik sus. | | | | | | | | | |
| (2WD) 114d, 116d, 118d, 120d, 125d, 114i, 116i, 118i, 120i, 125i ⊕ Sport sus. Exc. M models, Exc. Adaptive sus., M Performance | (F21, F20) 11.10 - | | 3348027 | | | | | | |
| 1) incl. Sport sus., , M-Technik sus., Adaptive sus., M Performance | | | | | | | | | |



BMW

| MODEL FAHRZEUG MODELE | YEAR JAHR ANNEE | FRONT/VORNE/AVANT | | | | REAR/HINTEN/ARRIERE | | | |
|-----------------------------|-----------------------|-----------------------------|-----------------------------|--------------------------------|--|-----------------------------|-----------------------------|--------------------------------|--|
| | | PREMIUM Twin-tube Oil | EXCEL-G Twin-tube Gas | GAS-A-JUST Mono-tube Gas | | PREMIUM Twin-tube Oil | EXCEL-G Twin-tube Gas | GAS-A-JUST Mono-tube Gas | |

BMW (D)

2 Series (F22) Exc. M-Technik sus.

| | | | | | | | | |
|--|-------|---------|----------|------------------------|--|----------|---------|--|
| (2WD) 218d, 220d, 225d 218i, 220i, 228i, 230i Exc. Sport sus. Exc. Adaptive sus., M Performance | (F22) | 10.13 - | | 3348027 | | | 3448017 | |
| | | | ∞ 910231 | | | ∞ 910234 | | |
| (2WD) M 235i, M 240i Exc. Adaptive sus., M Performance | (F22) | 10.13 - | | 3348028 | | | 3448018 | |
| | | | | | | | | |
| (4WD) 220d Exc. Sport sus. Exc. Adaptive sus., M Performance | (F22) | 6.14 - | | | | | 3448017 | |
| | | | ∞ 910231 | | | ∞ 910234 | | |
| (4WD) M 235i Exc. Adaptive sus., M Performance | (F22) | 7.14 - | | 3348026 L 3348025 R | | | 3448017 | |
| | | | | | | | | |
| (4WD) M 240i Exc. Adaptive sus., M Performance | (F22) | 9.15 - | | 3348046 L 3348045 R | | | 3448018 | |
| | | | | | | | | |
| (2WD) (4WD) ⊕ Sport sus. Exc. M models, Adaptive sus., M Performance | (F22) | 10.13 - | | | | | | |
| | | | | | | ∞ 910235 | | |

1) incl. Sport sus., M-Technik sus., Adaptive sus., M Performance

2 Series (F22) ⊕ M-Technik sus.

| | | | | | | | | |
|---|-------|---------|--|---------|--|--|--|--|
| (2WD) 218d, 220d, 225d 218i, 220i, 228i, 230i ⊕ Sport sus. Exc. Adaptive sus., M Performance | (F22) | 10.13 - | | 3348027 | | | | |
| | | | | | | | | |

1) incl. Sport sus., M-Technik sus., Adaptive sus., M Performance

2 Series (F23) Exc. M-Technik sus.

| | | | | | | | | |
|--|-------|---------|----------|---------|--|----------|---------|--|
| (2WD) 220d (140 kW) 220i (115 kW = N20B20B), 228i Exc. M models, Sport sus. Exc. Adaptive sus., M Performance | (F23) | 3.14 - | | 3348027 | | | 3448017 | |
| | | | ∞ 910231 | | | ∞ 910234 | | |
| (2WD) 218d, 220d (120 kW), 225d 218i, 220i (115 kW = B48B20A), 230i Exc. Sport sus. Exc. Adaptive sus., M Performance | (F23) | 3.14 - | | 3348027 | | | 3448018 | |
| | | | ∞ 910231 | | | ∞ 910234 | | |
| (2WD) M 235i, M 240i Exc. Adaptive sus., M Performance | (F23) | 11.14 - | | 3348028 | | | 3448018 | |
| | | | | | | | | |

1) incl. Sport sus., M-Technik sus., Adaptive sus.



| MODEL FAHRZEUG MODELE | YEAR JAHR ANNEE | FRONT/VORNE/AVANT | | | | REAR/HINTEN/ARRIERE | | | |
|--|-----------------------|-----------------------------|-----------------------------|--------------------------------|--|-----------------------------|-----------------------------|--------------------------------|--|
| | | PREMIUM Twin-tube Oil | EXCEL-G Twin-tube Gas | GAS-A-JUST Mono-tube Gas | | PREMIUM Twin-tube Oil | EXCEL-G Twin-tube Gas | GAS-A-JUST Mono-tube Gas | |
| BMW (D) | | | | | | | | | |
| 2 Series (F23) Exc. M-Technik sus. | | | | | | | | | |
| (4WD) M 235i, M 240i Exc. Adaptive sus., M Performance | (F23) | 7.15 - | | 3348046 L 3348045 R | | | 3448018 | | |
| (2WD) (4WD) ⊕ Sport sus. Exc. M models, Adaptive sus., M Performance | (F23) | 3.14 - | | | | | | | |
| 1) incl. Sport sus., M-Technik sus., Adaptive sus. | | | | | | | | | |
| 2 Series (F23) ⊕ M-Technik sus. | | | | | | | | | |
| (2WD) 218i, 220i (135 kW), 228i, 230i 218d, 220d, 225d ⊕ Sport sus. Exc. Adaptive sus. | (F23) | 3.14 - | | 3348027 | | | | | |
| SM9926 | | | | | | | | | |
| 2 Series Active Tourer (F45) | | | | | | | | | |
| (2WD) (4WD) Incl. Hybrid Exc. Flex, Sport sus., M-Technik sus., | (F45) | 11.13 - | | 3348101 L 3348100 R | | | 3448034 | | |
| 910233 ¹⁾ SM9926 | | | | | | | | | |
| (2WD) (4WD) ⊕ Sport sus., M-Technik sus. Exc. Flex, Hybrid, | (F45) | 11.13 - 12.14 | | 3348101 L 3348100 R | | | 3448034 | | |
| 910231 SM9926 | | | | | | | | | |
| (2WD) (4WD) ⊕ Sport sus., M-Technik sus. Exc. Flex, Hybrid, | (F45) | 1.15 - | | 3348101 L 3348100 R | | | | | |
| 910231 SM9926 | | | | | | | | | |
| 1) Incl. | | | | | | | | | |
| 2 Series Gran Tourer (F46) | | | | | | | | | |
| (2WD) (4WD) Exc. Sport sus., M-Technik sus., | (F46) | 7.14 - | | 3348101 L 3348100 R | | | 3448034 | | |
| 910233 ¹⁾ SM9926 | | | | | | | | | |
| (2WD) (4WD) ⊕ Sport sus., M-Technik sus. Exc. | (F46) | 7.14 - | | 3348101 L 3348100 R | | | | | |
| 910231 SM9926 | | | | | | | | | |
| 1) Incl. | | | | | | | | | |
| 3 Series (E21) | | | | | | | | | |
| 316, 318, 318 A, 320, 320 A, 320i, 320 (6 cyl.) 315, 318i | (E21) | 10.76 - 10.82 80 - 82 | 663002 | | | 441003 | 341015 ▼ | | |
| 910084 SM1002 | | | | | | | | | |



BMW

| MODEL FAHRZEUG MODELE | YEAR JAHR ANNEE | FRONT/VORNE/AVANT | | | | REAR/HINTEN/ARRIERE | | | |
|---|-----------------------|-----------------------------|-----------------------------|--|--|-----------------------------|-----------------------------|--------------------------------|--|
| | | PREMIUM Twin-tube Oil | EXCEL-G Twin-tube Gas | GAS-A-JUST Mono-tube Gas | | PREMIUM Twin-tube Oil | EXCEL-G Twin-tube Gas | GAS-A-JUST Mono-tube Gas | |
| BMW (D) | | | | | | | | | |
| 3 Series (E21) | | | | | | | | | |
| 323i | (E21) | 78 - 10.82 | | 365042 | | 441003 | 341015 ▼ | | |
| | | | 910084 | SM1002 | | | | | |
| 3 Series (E30) Exc. M-Technik sus. | | | | | | | | | |
| 316, 316i, 318i, 318iS, 324d Exc. Sport | (E30) | 82 - 12.90 | 663500 ¹⁾ | 363500 ¹⁾ 373019 ²⁾ | | 443207 | 343184 | 243019 | |
| | | | 910084 | SM1000 | | | SM9000 | | |
| 320i Exc. Sport | (E30) | 82 - 9.87 | 663500 ¹⁾ | 363500 ¹⁾ 373019 ¹⁾ | | 443207 | 343184 | 243019 | |
| | | | 910084 | SM1000 | | | SM9000 | | |
| 320i Exc. Sport | (E30) | 10.87 - 12.90 | | 363500 ¹⁾ 373019 ¹⁾ | | | 343184 | 243019 | |
| | | | 910084 | SM1000 | | | SM9000 | | |
| 316/316i Sport 318i/318iS Sport 320i Sport 324d Sport | (E30) | 82 - 12.90 | | 364021 ²⁾ 374008 ²⁾ | | | 343184 | 243019 | |
| | | | 910084 | SM1000 | | | SM9000 | | |
| 320iS, 323i, 324td, 325e, 325i Incl. Sport Exc. (4WD) (325iX) | (E30) | 82 - 12.90 | | 364021 ²⁾ 374008 ²⁾ | | | 343184 | 243019 | |
| | | | 910084 | SM1000 | | | SM9000 | | |
| 3 Series (E30) Exc. M-Technik sus. | | | | | | | | | |
| 318i, 320i, 325i Incl. Sport Exc. (4WD) (325iX) | (E30) | 85 - 2.93 | | 364021 ²⁾ 374008 ²⁾ | | | 343184 | 243019 | |
| | | | 910084 | SM1000 | | | SM9000 | | |
| 3 Series Touring (E30) Exc. M-Technik sus. | | | | | | | | | |
| 316i, 318i Exc. Sport | (E30) | 3.89 - 9.89 | | 363500 ¹⁾ 373019 ¹⁾ | | | 343184 | 243019 | |
| | | | 910084 | SM1000 | | | SM9000 | | |
| 316i, 318i Exc. Sport | (E30) | 10.89 - 2.94 | | 364021 ²⁾ 374008 ²⁾ | | | 343184 | 243019 | |
| | | | 910084 | SM1000 | | | SM9000 | | |
| <p>1) 2) </p> | | | | | | | | | |



| MODEL FAHRZEUG MODELE | YEAR JAHR ANNEE | FRONT/VORNE/AVANT | | | | REAR/HINTEN/ARRIERE | | | |
|--|-----------------------|--------------------------------------|-----------------------------|--|--|-----------------------------|-----------------------------|--------------------------------|--|
| | | PREMIUM Twin-tube Oil | EXCEL-G Twin-tube Gas | GAS-A-JUST Mono-tube Gas | | PREMIUM Twin-tube Oil | EXCEL-G Twin-tube Gas | GAS-A-JUST Mono-tube Gas | |
| BMW (D) | | | | | | | | | |
| 3 Series Touring (E30) Exc. M-Technik sus. | | | | | | | | | |
| 316i Sport 318i Sport | (E30) | 3.89 - 2.94 | | 364021 ¹⁾ 374008 ¹⁾ | | | 343184 | 243019 | |
| | | | 910084 | SM1000 | | | SM9000 | | |
| 320i, 324td, 325i Incl. Sport Exc. (4WD) (325iX) | (E30) | 88 - 2.94 | | 364021 ¹⁾ 374008 ¹⁾ | | | 343184 | 243019 | |
| | | | 910084 | SM1000 | | | SM9000 | | |
| 3 Series (E30) M-Technik sus. Exc. (4WD) (325iX), M3 | | | | | | | | | |
| ALL | (E30) | 82 - 12.90 85 - 2.93 89 - 2.94 | | 374008 ¹⁾ | | | | 243019 | |
| | | | | SM1000 | | | SM9000 | | |
| <p>1)</p> | | | | | | | | | |
| 3 Series (E30) M3 | | | | | | | | | |
| ALL | (E30) | 87 - 91 | | | | | | | |
| | | | | SM1000 | | | SM9000 | | |
| 3 Series Compact (E36) Exc. M-Technik sus. | | | | | | | | | |
| 316g, 316i, 318ti, 318tds Exc. 323ti, (EU) | (E36) | 4.94 - 01 | | 333910 L 333909 R | | | 343268 | 553192▼ | |
| | | | 910084 | SM1001 | | 915002 | SM9000 | | |
| (EU) 316g, 316i, 318ti, 318tds Exc. 323ti | (E36) | 4.94 - 01 | | | | | 343268 | 553192▼ | |
| | | | OE= 31311 091 624/ 623(R/L) | SM1001 | | 915002 | SM9000 | | |
| 323 ti | | 8.97 - 8.00 | | | | | | | |
| | | | 910084 | SM1001 | | | SM9000 | | |
| 3 Series Compact (E36) M-Technik sus. | | | | | | | | | |
| 316g, 316i, 318ti, 318tds Exc. 323ti, (EU) | (E36) | 4.94 - 01 | | 333933 L▼ 333932 R▼ 333910 L 333909 R | | | | 553192▼ Incl. (EU) | |
| | | | | SM1001 | | | SM9000 | | |
| 323 ti | | 8.97 - 8.00 | | | | | | | |
| | | | | SM1001 | | | SM9000 | | |



BMW

| MODEL FAHRZEUG MODELE | YEAR JAHR ANNEE | FRONT/VORNE/AVANT | | | | REAR/HINTEN/ARRIERE | | | |
|-----------------------------|-----------------------|-----------------------------|-----------------------------|--------------------------------|--|-----------------------------|-----------------------------|--------------------------------|--|
| | | PREMIUM Twin-tube Oil | EXCEL-G Twin-tube Gas | GAS-A-JUST Mono-tube Gas | | PREMIUM Twin-tube Oil | EXCEL-G Twin-tube Gas | GAS-A-JUST Mono-tube Gas | |

BMW (D)

3 Series (E36) Exc. M-Technik sus.

| | | | | | | | | |
|---|--------------|--------|-----------------------------|--|--------|--------|---------|--|
| 316i, 318i (E36) | 90 - 8.91 | | 333916 L 333915 R | | | 343255 | 553180▼ | |
| | | 910084 | SM1001 | | 915002 | SM9000 | | |
| 316i, 318i, 318iS (E36) | 9.91 - 5.92 | | 333918 L 333917 R | | | 343255 | 553180▼ | |
| | | 910084 | SM1001 | | 915002 | SM9000 | | |
| 316i, 318i, 318tds, 318iS Exc. | 6.92 - 3.98 | | 333910 L 333909 R | | | 343255 | 553180▼ | |
| | | 910084 | SM1001 | | 915002 | SM9000 | | |
| 316i, 318i, 318iS, 318tds (E36) | 6.92 - 3.98 | | OE= 31311 091 624/ 623(R/L) | | | 343255 | 553180▼ | |
| | | | SM1001 | | 915002 | SM9000 | | |
| 320i, 325i, 325td (E36) | 90 - 8.91 | | 334924 L 334923 R | | | 343255 | 553180▼ | |
| | | 910084 | SM1001 | | 915002 | SM9000 | | |
| 320i, 325i, 325td (E36) | 9.91 - 5.92 | | 334926 L 334925 R | | | 343255 | 553180▼ | |
| | | 910084 | SM1001 | | 915002 | SM9000 | | |
| 320i, 323i, 325i 328i, 325td, 325tds Exc. | 6.92 - 1.95 | | 334902 L 334901 R | | | 343255 | 553180▼ | |
| | | 910084 | SM1001 | | 915002 | SM9000 | | |
| 320i, 323i, 325i 328i, 325td, 325tds Exc. | 2.95 - 3.98 | | 333920 L 333919 R | | | 343255 | 553180▼ | |
| | | 910084 | SM1001 | | 915002 | SM9000 | | |
| 320i, 323i, 325i, 328i, 325td, 325tds (E36) | 6.92 - 3.98 | | OE= 31311 091 624/ 623(R/L) | | | 343255 | 553180▼ | |
| | | | SM1001 | | 915002 | SM9000 | | |
| M3 (E36) | 10.92 - 4.99 | | | | | | | |
| | | | | | 915002 | | | |

3 Series (E36) M-Technik sus.

| | | | | | | | | |
|-------------------------------------|--|--------|--|--|--------|--------|---------|--|
| 316i 318i (E36) | 3.91 - 8.91 12.90 - 8.91 | | | | | | 553180▼ | |
| | | | SM1001 | | 915002 | SM9000 | | |
| 316i, 318i (E36) | 9.91 - 5.92 | | | | | | 553180▼ | |
| | | 910084 | SM1001 | | 915002 | SM9000 | | |
| 316i, 318i 318iS 318tds (E36) | 6.92 - 98 6.94 - 98 5.94 - 98 | | 333933 L▼ 333932 R▼ 333910 L 333909 R | | | | 553180▼ | |
| | | 910084 | SM1001 | | 915002 | SM9000 | | |
| 320i 325i 325td (E36) | 3.91 - 8.91 12.90 - 8.91 1.91 - 8.91 | | | | | | 553180▼ | |
| | | 910084 | SM1001 | | 915002 | SM9000 | | |



| MODEL FAHRZEUG MODELE | YEAR JAHR ANNEE | FRONT/VORNE/AVANT | | | | REAR/HINTEN/ARRIERE | | | |
|--|-----------------------|---|-----------------------------|--|--|-----------------------------|-----------------------------|--------------------------------|--|
| | | PREMIUM Twin-tube Oil | EXCEL-G Twin-tube Gas | GAS-A-JUST Mono-tube Gas | | PREMIUM Twin-tube Oil | EXCEL-G Twin-tube Gas | GAS-A-JUST Mono-tube Gas | |
| BMW (D) | | | | | | | | | |
| 3 Series (E36) ⊕ M-Technik sus. | | | | | | | | | |
| 320i 325i 325td | (E36) | 9.91 - 5.92 | | | | | | 553180▼ | |
| | | 9.91 - 5.92 | | | | | | | |
| | | 9.91 - 5.92 | 910084 | SM1001 | | 915002 | SM9000 | | |
| M3 | (E36) | 8.94 - 2.98 | | | | | | | |
| | | | | | | 915002 | | | |
| 3 Series (E36) ⊕ M-Technik sus. | | | | | | | | | |
| 318iS | (E36) | 1.92 - 5.92 | | | | | | 553180▼ | |
| | | | 910084 | SM1001 | | | SM9000 | | |
| 320i, 325i | (E36) | 1.92 - 5.92 | | | | | | 553180▼ | |
| | | | 910084 | SM1001 | | | SM9000 | | |
| 316i 318iS | (E36) | 10.93 - 4.99 6.92 - 4.99 | | 333933 L▼ 333932 R▼ 333910 L 333909 R | | | | 553180▼ | |
| | | | 910084 | SM1001 | | | SM9000 | | |
| 320i 323i 325i 328i | (E36) | 6.92 - 99 2.95 - 99 6.92 - 99 10.94 - 99 | | 334938 L 334937 R SM1001 | | | | 553180▼ | |
| | | | | | | | SM9000 | | |
| M3 | (E36) | 10.92 - 4.99 | | | | | | | |
| | | | | | | 915002 | | | |
| 3 Series (E36) Exc. M-Technik sus. | | | | | | | | | |
| 318i 320i, 323i, 325i, 328i Exc. | (E36) | 1.94 - 1.95 3.93 - 3.98 | | 334902 L 334901 R | | | 343255 | 553180▼ | |
| | | | 910084 | SM1001 | | 915002 | SM9000 | | |
| 318i Exc. | (E36) | 2.95 - 3.98 | | 333920 L 333919 R | | | 343255 | 553180▼ | |
| | | | 910084 | SM1001 | | 915002 | SM9000 | | |
| 318i, 320i, 323i, 325i, 328i | (E36) | 3.93 - 3.98 | | OE= 31311 091 624/ 623(R/L) SM1001 | | | 343255 | 553180▼ | |
| | | | | | | | SM9000 | | |
| M3 | (E36) | 1.94 - 4.99 | | | | | | | |
| | | | | | | 915002 | | | |
| 3 Series (E36) ⊕ M-Technik sus. | | | | | | | | | |
| 318i 320i 323i 325i 328i | (E36) | 1.94 - 99 11.93 - 99 2.95 - 99 3.93 - 99 11.94 - 99 | | 334938 L 334937 R SM1001 | | | | 553180▼ | |
| | | | | | | 915002 | SM9000 | | |
| M3 | (E36) | 1.94 - 4.99 | | | | | | | |
| | | | | | | 915002 | | | |



BMW

| MODEL FAHRZEUG MODELE | YEAR JAHR ANNEE | FRONT/VORNE/AVANT | | | REAR/HINTEN/ARRIERE | | |
|---|--|--------------------------------|--|--------------------------------|-----------------------------|-----------------------------|--------------------------------|
| | | PREMIUM Twin-tube Oil | EXCEL-G Twin-tube Gas | GAS-A-JUST Mono-tube Gas | PREMIUM Twin-tube Oil | EXCEL-G Twin-tube Gas | GAS-A-JUST Mono-tube Gas |
| BMW (D) | | | | | | | |
| 3 Series Touring (E36) Exc. M-Technik sus. | | | | | | | |
| 316i, 318i, 320i, 323i, 328i, 318tds Exc. | (E36) 10.94 - 99 | | 333920 L 333919 R | | 343352 | 553239 | |
| | | 910084 | SM1001 | | 915002 | SM9000 | |
| | (E36) 10.94 - 99 | OE = 31311 091 624 / 623 (R/L) | | | | | |
| | | | | | | SM9000 | |
| 3 Series Touring (E36) M-Technik sus. | | | | | | | |
| 318i, 328i 318tds, 320i, 323i, 325tds | (E36) 11.95 - 99 10.94 - 99 | | | | 343352 | 553239 | |
| | | | SM1001 | | 915002 | SM9000 | |
| 3 Series (E46) Exc. M-Technik sus. | | | | | | | |
| 316i (77 kW, 1596 ccm) 316i (77 kW, 1895 ccm) 318i (87 kW) 320d (100 kW) Exc. Sport sus., | (E46) 4.00 - 2.05 9.98 - 2.05 2.98 - 9.01 4.98 - 9.01 | | 339728 L ¹⁾ 339727 R ¹⁾ | | 343352 | 553239 | |
| | | 910084 | SM1003 | | 915002 | SM9000 | |
| 320i 323i 325i 328i Exc. Sport sus., | (E46) 3.98 - 2.05 3.98 - 9.00 9.00 - 2.05 9.98 - 6.00 | | 334946 L ¹⁾ 334945 R ¹⁾ | | 343352 | 553239 | |
| | | 910084 | SM1003 | | 915002 | SM9000 | |
| 330i 330d (135 kW) Exc. Sport sus., | (E46) 6.00 - 2.05 10.99 - 2.05 | | 334946 L ²⁾ 334945 R ²⁾ | | 343352 | 553239 | |
| | | 910084 | SM1003 | | 915002 | SM9000 | |
| 316i (85 kW) 318i (105 kW), 318d, 320d (110 kW) 330d (150 kW) Exc. Sport sus., | (E46) 2.02 - 2.05 9.01 - 2.05 3.03 - 2.05 | | | | 343352 | 553239 | |
| | | 910084 | SM1003 | | 915002 | SM9000 | |
| Sport sus. 316i 318i 320i 323i 325i 328i 318d 320d | (E46) 9.98 - 2.05 2.98 - 2.05 3.98 - 2.05 3.98 - 9.00 9.00 - 2.05 2.98 - 6.00 9.01 - 2.05 2.98 - 4.05 | | | | 343352 | 553239 | |
| | | 910084 | SM1003 | | 915002 | SM9000 | |
| | (E46) 1.00 - 2.05 | | | | | | |
| | | | SM1003 | | | SM9000 | |
| 1) → 9.01 2) → 4.01 | | | | | | | |
| 3 Series (E46) Exc. M-Technik sus. | | | | | | | |
| 316Ci, 318Ci Exc. Sport sus., | (E46) 11.99 - 9.06 | | 334615 L 334614 R | | 343352 | 553239 | |
| | | 910084 | SM1003 | | 915002 | SM9000 | |



| MODEL FAHRZEUG MODELE | YEAR JAHR ANNEE | FRONT/VORNE/AVANT | | | | REAR/HINTEN/ARRIERE | | | |
|--|---|-----------------------------|-----------------------------|--------------------------------|--|-----------------------------|-----------------------------|--------------------------------|--|
| | | PREMIUM Twin-tube Oil | EXCEL-G Twin-tube Gas | GAS-A-JUST Mono-tube Gas | | PREMIUM Twin-tube Oil | EXCEL-G Twin-tube Gas | GAS-A-JUST Mono-tube Gas | |
| BMW (D) | | | | | | | | | |
| 3 Series (E46) Exc. M-Technik sus. | | | | | | | | | |
| ⊕ Sport sus. 316Ci, 318Ci (E46) | 11.99- 9.06 | | 334615 L 334614 R | | | | 343352 | 553239 | |
| | | 910084 | SM1003 | | | 915002 | SM9000 | | |
| 320Ci 323Ci, 328Ci 325Ci 330Ci 320Cd 330Cd Exc. Sport sus., , Xi (E46) | 8.99- 9.06 4.99- 9.00 00- 9.06 6.00- 9.06 11.03- 9.06 3.03- 9.06 | | 334946 L 334945 R | | | | 343352 | 553239 | |
| | | 910084 | SM1003 | | | 915002 | SM9000 | | |
| ⊕ Sport sus. 320Ci 323Ci 325Ci 328Ci 320Cd 330Cd (E46) | 8.99- 9.06 4.99- 9.00 9.01- 9.06 4.99- 6.00 11.03- 9.06 3.03- 9.06 | | 334615 L 334614 R | | | | 343352 | 553239 | |
| | | 910084 | SM1003 | | | 915002 | SM9000 | | |
| 3 Series (E46) Exc. M-Technik sus. | | | | | | | | | |
| 318Ci, 320Ci, 323Ci, 325Ci, 330Ci 320Cd, 330Cd Exc. Sport sus., , M3 (E46) | 4.00- | | 334946 L 334945 R | | | | 343352 | 553239 | |
| | | 910084 | SM1003 | | | 915002 | SM9000 | | |
| 318Ci, 320Ci, 323Ci, 325Ci, 330Ci 320Cd, 330Cd ⊕ Sport sus. Exc. M3 (E46) | 4.00- | | 334615 L 334614 R | | | | 343352 | 553239 | |
| | | 910084 | SM1003 | | | 915002 | SM9000 | | |
| 3 Series Touring (E46) Exc. M-Technik sus. | | | | | | | | | |
| 316i, 318d 318i 320d Exc. Sport sus., (E46) | 3.02- 2.05 10.99- 2.05 3.00- 2.05 | | 339728 L 339727 R | | | | 343352 | 553239 | |
| | | 910084 | SM1003 | | | 915002 | SM9000 | | |
| ⊕ Sport sus. 316i (E46) | 3.02- 2.05 | | 334615 L 334614 R | | | | 343352 | 553239 | |
| | | 910084 | SM1003 | | | 915002 | SM9000 | | |
| 320i 328i Exc. Sport sus., (E46) | 10.99- 2.05 10.99- 6.00 | | 334946 L 334945 R | | | | 343352 | 553239 | |
| | | 910084 | SM1003 | | | 915002 | SM9000 | | |
| 325i 330i 330d Exc. Sport sus., (E46) | 9.00- 2.05 6.00- 2.05 10.99- 2.05 | | | | | | 343352 | 553239 | |
| | | 910084 | SM1003 | | | 915002 | SM9000 | | |
| 318i, 320i, 325i, 328i, 330i 320d, 330d ⊕ Sport sus. (E46) | 10.99- 2.05 | | | | | | 343352 | 553239 | |
| | | 910084 | SM1003 | | | 915002 | SM9000 | | |
| (E46) | 1.00- 5.05 | | | | | | | | |
| | | | SM1003 | | | | SM9000 | | |



BMW

| MODEL FAHRZEUG MODELE | YEAR JAHR ANNEE | FRONT/VORNE/AVANT | | | | REAR/HINTEN/ARRIERE | | | |
|---|----------------------------|-----------------------------|--|--------------------------------|--|-----------------------------|-----------------------------|--------------------------------|--|
| | | PREMIUM Twin-tube Oil | EXCEL-G Twin-tube Gas | GAS-A-JUST Mono-tube Gas | | PREMIUM Twin-tube Oil | EXCEL-G Twin-tube Gas | GAS-A-JUST Mono-tube Gas | |
| BMW (D) | | | | | | | | | |
| 3 Series Compact (E46) | | | | | | | | | |
| 316ti (E46) 318ti Incl. Sport sus. | 6.01 - 2.05 9.01 - 2.05 | | 334615 L 334614 R | | | | 343352 | 553239 | |
| | | 910084 | SM1003 | | | 915002 | SM9000 | | |
| 325ti (E46) 320td Exc. Sport sus. | 6.01 - 2.05 9.01 - 2.05 | | | | | | 343352 | 553239 | |
| | | 910084 | SM1003 | | | 915002 | SM9000 | | |
| 3 Series (E90) Exc. M-Technik sus. | | | | | | | | | |
| (E90) Exc. , Sport sus., M3 | 1.05 - 12.11 | | 339270 L 339269 R | | | | 349041 | | |
| | | 910084 | SM1003 | | | 910172 | SM9008▼ SM5752 | | |
| (E90) Exc. Sport sus., M3 | 1.05 - 12.11 | | 339270 L 339269 R | | | | 349042 | | |
| | | | SM1003 | | | | | | |
| (E90) 320xd, 330xd, 325xi, 330xi, 335xi (225 kW), 320d xDrive, 330d xDrive, 325i xDrive, 330i xDrive, 335i xDrive | 1.05 - 12.11 | | | | | | | | |
| | | | SM1027 ¹⁾ SM1028 ¹⁾ | | | 910172 ²⁾ | SM9008▼ SM5752 | | |
| 1) | | SM1027 | SM1028 | 2) Exc. Sport sus. | | | | | |
| 320xd, 335xi (225 kW), 320d xDrive (120 kW, 130 kW), 330d xDrive, 330i xDrive, 335i xDrive | → 2.10 | | 3.10 → 12.11 | | | | | | |
| 325i xDrive | → 3.10 | | 4.10 → 12.11 | | | | | | |
| 330xd, 325xi, 330xi | → 12.11 | | ∅ | | | | | | |
| 320d xDrive (135 kW) | ∅ | | → 12.11 | | | | | | |
| 3 Series Touring (E91) Exc. M-Technik sus. | | | | | | | | | |
| (E91) 316i, 318i, 320i, 323i, 325i, 330i, 335i 316d, 318d, 320d, 325d, 330d, 335d Exc. Sport sus., | 9.05 - | | 339270 L 339269 R | | | | 349041 | | |
| | | 910084 | SM1003 | | | 910195 | SM9008▼ SM5752 | | |
| (E91) 320xd, 330xd, 325xi, 330xi, 335xi, 320d xDrive, 330d xDrive, 325i xDrive, 330i xDrive, 335i xDrive | 9.05 - 6.12 | | | | | | | | |
| | | | SM1027 ¹⁾ SM1028 ¹⁾ | | | 910195 | SM9008▼ SM5752 | | |
| 1) | | SM1027 | SM1028 | | | | | | |
| 330xi (200 kW), 320d xDrive, 330d xDrive, 325i xDrive, 330i xDrive, 335i xDrive | → 2.10 | | 3.10 → 6.12 | | | | | | |
| 320xd, 330xd, 325xi, 330xi (190 kW), 335xi | → 6.12 | | ∅ | | | | | | |
| 3 Series (E92) Exc. M-Technik sus. | | | | | | | | | |
| (E92) 316i, 318i, 320i, 323i, 325i, 330i, 335i, 320d, 325d, 330d, 335d Exc. Sport sus. | 9.06 - | | 339270 L 339269 R | | | | 349041 | | |
| | | 910084 | SM1003 | | | 910172 | SM9008▼ SM5752 | | |



| MODEL FAHRZEUG MODELE | YEAR JAHR ANNEE | FRONT/VORNE/AVANT | | | REAR/HINTEN/ARRIERE | | | | | | | | | | | | |
|---|-----------------------------|-----------------------------|---------------------------------------|--|---|-----------------------------|-----------------------------|--------------------------------|--|--------|--------------|---|---------|---|----------------------|---|---------|
| | | PREMIUM Twin-tube Oil | EXCEL-G Twin-tube Gas | GAS-A-JUST Mono-tube Gas | | PREMIUM Twin-tube Oil | EXCEL-G Twin-tube Gas | GAS-A-JUST Mono-tube Gas | | | | | | | | | |
| BMW (D) | | | | | | | | | | | | | | | | | |
| 3 Series (E92) Exc. M-Technik sus. | | | | | | | | | | | | | | | | | |
| (4WD) 320xd, 330xd, 325xi, 330xi, 335xi, 320d xDrive, 330d xDrive, 325i xDrive, 330i xDrive, 335i xDrive | (E92) 3.06 - 12.13 | | | SM1027 ¹⁾ SM1028 ¹⁾ | 910172 ²⁾ SM9008▼ SM5752 | | | | | | | | | | | | |
| 1) <table border="1"> <thead> <tr> <th></th> <th>SM1027</th> <th>SM1028</th> </tr> </thead> <tbody> <tr> <td>330xd (180 kW), 320d xDrive (130 kW), 330d xDrive, 325i xDrive, 330i xDrive, 335i xDrive</td> <td>→ 3.10</td> <td>4.10 → 12.13</td> </tr> <tr> <td>320xd, 330xd (170 kW), 325xi, 330xi, 335xi</td> <td>→ 12.13</td> <td>∅</td> </tr> <tr> <td>320d xDrive (135 kW)</td> <td>∅</td> <td>→ 12.13</td> </tr> </tbody> </table> 2) Exc. Sport sus. | | | | | | | SM1027 | SM1028 | 330xd (180 kW), 320d xDrive (130 kW), 330d xDrive, 325i xDrive, 330i xDrive, 335i xDrive | → 3.10 | 4.10 → 12.13 | 320xd, 330xd (170 kW), 325xi, 330xi, 335xi | → 12.13 | ∅ | 320d xDrive (135 kW) | ∅ | → 12.13 |
| | SM1027 | SM1028 | | | | | | | | | | | | | | | |
| 330xd (180 kW), 320d xDrive (130 kW), 330d xDrive, 325i xDrive, 330i xDrive, 335i xDrive | → 3.10 | 4.10 → 12.13 | | | | | | | | | | | | | | | |
| 320xd, 330xd (170 kW), 325xi, 330xi, 335xi | → 12.13 | ∅ | | | | | | | | | | | | | | | |
| 320d xDrive (135 kW) | ∅ | → 12.13 | | | | | | | | | | | | | | | |
| 3 Series (E93) Exc. M-Technik sus. | | | | | | | | | | | | | | | | | |
| 318i, 320i, 325i, 330i, 335i 320d, 325d, 330d Exc. Sport sus., | (E93) 3.07 - | | 339270 L 339269 R 910084 SM1003 | 349041 910195 SM9008▼ SM5752 | | | | | | | | | | | | | |
| 3 Series (F30, F80) | | | | | | | | | | | | | | | | | |
| (2WD) Exc. M3, Sport sus., M-Technik sus. Exc. Adaptive sus., , M Performance | (F30, F80) 11.11 - 10.18 | | 3348027 910231 | 3448017 910234 SM9926 | | | | | | | | | | | | | |
| (2WD) 316i, 318i, 320i, 328i, 330i, 340i (240 kW), 335i 316d, 318d, 320d, 325d 330e ⊕ Sport sus., M-Technik sus. Exc. Adaptive sus., , M Performance | (F30, F80) 11.11 - 10.18 | | 3348028 | 3448017 910236 SM9926 | | | | | | | | | | | | | |
| (2WD) 340i (265 kW) 330d ⊕ Sport sus., M-Technik sus. Exc. Adaptive sus., , M Performance | (F30, F80) 7.12 - 10.18 | | 3348027 | 3448017 910236 SM9926 | | | | | | | | | | | | | |
| (2WD) Adaptive sus., M-Technik sus. Exc. Sport sus., , M Performance | (F30, F80) 11.11 - 10.18 | | 3348028 | 3448017 SM9926 | | | | | | | | | | | | | |
| (4WD) 320i, 328i, 330i, 335i, 340i 318d (105 kW), 320d, 330d, 335d Exc. Adaptive sus., M-Technik sus., | (F30, F80) 7.12 - 10.18 | | 3348026 L 3348025 R | 3448017 910234 SM9926 | | | | | | | | | | | | | |
| (4WD) 318d (110 kW) ⊕ Exc. Sport sus., Adaptive sus., M-Technik sus., | (F30, F80) 7.15 - 2.18 | | 3348026 L 3348025 R | 3448017 910234 SM9926 | | | | | | | | | | | | | |



BMW

| MODEL FAHRZEUG MODELE | YEAR JAHR ANNEE | FRONT/VORNE/AVANT | | | | REAR/HINTEN/ARRIERE | | | |
|---|-----------------------|-----------------------------|-----------------------------|--------------------------------|--|-----------------------------|-----------------------------|--------------------------------|--|
| | | PREMIUM Twin-tube Oil | EXCEL-G Twin-tube Gas | GAS-A-JUST Mono-tube Gas | | PREMIUM Twin-tube Oil | EXCEL-G Twin-tube Gas | GAS-A-JUST Mono-tube Gas | |
| BMW (D) | | | | | | | | | |
| 3 Series (F30, F80) | | | | | | | | | |
| (4WD) (F30, F80) 318d (110 kW) ⊕ AT Exc. Sport sus., Adaptive sus., M-Technik sus., | 7.15 - 2.18 | | 3348027 | | | | 3448017 | | |
| | | | | | | 910234 | SM9926 | | |
| (4WD) (F30, F80) 318d (110 kW) ⊕ Sport sus., M-Technik sus. Exc. Adaptive sus., | 7.15 - 2.18 | | 3348028 | | | | 3448017 | | |
| | | | | | | | SM9926 | | |
| 3 Series Touring (F31) | | | | | | | | | |
| (2WD) (F31) Exc. 325d (165 kW), Sport sus. Exc. Adaptive sus., M-Technik sus., | 7.12 - 6.19 | | 3348027 | | | | 3448017 | | |
| | | 910231 | | | | 910234 | SM9926 | | |
| (2WD) (F31) 325d (165 kW) Exc. Sport sus., Adaptive sus., M-Technik sus., | 3.16 - 2.18 | | 3348028 | | | | 3448017 | | |
| | | 910231 | | | | 910234 | SM9926 | | |
| (2WD) (F31) 316i, 320i (= N20 B20 B) 328i, 330i, 335i, 340i 316d, 318d (100 kW, 105 kW) 318d (110 kW) ⊕ , 320d, 330d ⊕ Sport sus., M-Technik sus. Exc. Adaptive sus., | 7.12 - 6.19 | | 3348027 | | | | 3448018 | | |
| | | | | | | 910236 | SM9926 | | |
| (2WD) (F31) 318i 318d (110 kW) ⊕ AT , 325d (155 kW, 160 kW) ⊕ Sport sus., M-Technik sus. Exc. Adaptive sus., | 3.13 - 6.19 | | 3348028 | | | | 3448018 | | |
| | | | | | | 910236 | SM9926 | | |
| (2WD) (F31) 320i (= B48 B20 A) ⊕ Sport sus., M-Technik sus. Exc. Adaptive sus., | 7.15 - 6.19 | | 3348027 | | | | 3448017 | | |
| | | | | | | 910236 | SM9926 | | |
| (2WD) (F31) 325d (165 kW) ⊕ Sport sus., M-Technik sus. Exc. Adaptive sus., | 3.16 - 2.18 | | 3348028 | | | | 3448017 | | |
| | | | | | | 910236 | SM9926 | | |
| (2WD) (F31) ⊕ Adaptive sus., M-Technik sus. Exc. Sport sus., | 7.12 - 6.19 | | 3348027 | | | | 3448018 | | |
| | | | | | | | SM9926 | | |
| (4WD) (F31) Exc. Adaptive sus., M-Technik sus., | 3.13 - 6.19 | | 3348026 L 3348025 R | | | | 3448017 | | |
| | | | | | | 910234 | SM9926 | | |



| MODEL FAHRZEUG MODELE | YEAR JAHR ANNEE | FRONT/VORNE/AVANT | | | | REAR/HINTEN/ARRIERE | | | |
|---|-----------------------|-----------------------------|-----------------------------|--------------------------------|--|-----------------------------|-----------------------------|--------------------------------|--|
| | | PREMIUM Twin-tube Oil | EXCEL-G Twin-tube Gas | GAS-A-JUST Mono-tube Gas | | PREMIUM Twin-tube Oil | EXCEL-G Twin-tube Gas | GAS-A-JUST Mono-tube Gas | |
| BMW (D) | | | | | | | | | |
| 3 Series Gran Turismo (F34) | | | | | | | | | |
| Exc. Sport sus., Adaptive sus., M-Technik sus., | (F34) | 3.13 - | | 3348027 | | | 3448017 | | |
| | | | ☞☞☞☞ 910231 | | | | ☞☞☞☞ 910234 | | |
| ⊕ Sport sus., M-Technik sus. Exc. Adaptive sus., | (F34) | 3.13 - | | 3348027 | | | 3448018 | | |
| | | | | | | | ☞☞☞☞ 910235 | | |
| Exc. Adaptive sus., M-Technik sus., | (F34) | 11.12 - | | 3348044 L 3348043 R | | | 3448018 | | |
| | | | ☞☞☞☞ 910231 | | | | ☞☞☞☞ 910234 | | |
| 4 Series (F32) | | | | | | | | | |
| 418d, 420d, 425d, 430d, 418i, 420i, 428i, 430i, 435i, 440i Exc. M-Technik sus., M Performance | (F32) | 7.13 - | | 3348027 | | | 3448017 | | |
| | | | | | | | ☞☞☞☞ 910235 ¹⁾ | | |
| 430d, 435i, 440i Incl. M Performance Exc. M-Technik sus. | (F32) | 7.13 - | | | | | 3448017 | | |
| | | | | | | | ☞☞☞☞ 910235 ¹⁾ | | |
| 418d, 420d, 425d, 430d, 418i, 420i, 428i, 430i, 435i ⊕ M-Technik sus., Sport sus. Exc. M Performance | (F32) | 7.13 - | | 3348028 | | | 3448018 | | |
| | | | | | | | | | |
| 440i ⊕ M-Technik sus., Sport sus. Exc. M Performance | (F32) | 3.16 - | | | | | 3448018 | | |
| | | | | | | | | | |
| 430d, 435i, 440i ⊕ M-Technik sus., Sport sus. ⊕ M Performance | (F32) | 7.13 - | | | | | 3448018 | | |
| | | | | | | | | | |
| 418d, 420d (140 kW) ⊕ M-Technik sus., Adaptive sus. Exc. M Performance | (F32) | 7.13 - | | 3348028 | | | 3448018 | | |
| | | | | | | | | | |
| 420d (120 kW, 135 kW) ⊕ M-Technik sus., Adaptive sus. Exc. M Performance | (F32) | 7.13 - | | | | | 3448018 | | |
| | | | | | | | | | |
| 425d, 440i ⊕ M-Technik sus., Adaptive sus. Exc. M Performance | (F32) | 7.13 - | | | | | 3448017 | | |
| | | | | | | | | | |

1) Exc. Sport sus., M Performance, Adaptive sus., M-Technik sus.

2) incl. Sport sus., M-Technik sus., M Performance, Adaptive sus.



BMW

| MODEL FAHRZEUG MODELE | YEAR JAHR ANNEE | FRONT/VORNE/AVANT | | | | REAR/HINTEN/ARRIERE | | | |
|---|-----------------------|-----------------------------|-----------------------------|--------------------------------|--|-----------------------------|-----------------------------|--------------------------------|--|
| | | PREMIUM Twin-tube Oil | EXCEL-G Twin-tube Gas | GAS-A-JUST Mono-tube Gas | | PREMIUM Twin-tube Oil | EXCEL-G Twin-tube Gas | GAS-A-JUST Mono-tube Gas | |
| BMW (D) | | | | | | | | | |
| 4 Series (F32) | | | | | | | | | |
| (4WD) 420d xDrive, 430d xDrive, 435d xDrive 420i xDrive, 428i xDrive, 430i xDrive 435i xDrive, 440i xDrive Incl. M Performance Exc. M-Technic sus., Adaptive sus. | (F32) 7.13 - | | 3348044 L 3348043 R | | | | 3448018 | | |
| SM9926 ¹⁾ | | | | | | | | | |
| 1) incl. Sport sus., M-Technik sus., M Performance, Adaptive sus. | | | | | | | | | |
| 4 Series (F33) | | | | | | | | | |
| (2WD) 420d, 425d, 420i, 428i, 430i, 435i, 440i Exc. M-Technik sus., M Performance | (F33) 10.13 - | | 3348027 | | | | 3448018 | | |
| SM9926 ³⁾ 910234 ¹⁾ 910236 ²⁾ | | | | | | | | | |
| (2WD) 430d Exc. M-Technik sus., M Performance | (F33) 10.13 - | | 3348027 | | | | 3448017 | | |
| SM9926 ³⁾ 910234 ¹⁾ 910236 ²⁾ | | | | | | | | | |
| (2WD) 420d, 435i, 440i Incl. M Performance Exc. M-Technik sus. | (F33) 10.13 - | | | | | | 3448018 | | |
| SM9926 ³⁾ 910234 ¹⁾ 910236 ²⁾ | | | | | | | | | |
| (2WD) 430d Incl. M Performance Exc. M-Technik sus. | (F33) 10.13 - | | | | | | 3448017 | | |
| SM9926 ³⁾ 910234 ¹⁾ 910236 ²⁾ | | | | | | | | | |
| (2WD) 420d, 425d, 420i, 428i, 430i M-Technik sus., Sport sus. Exc. M Performance | (F33) 10.13 - | | 3348027 | | | | 3448018 | | |
| SM9926 ³⁾ 910234 ¹⁾ 910236 ²⁾ | | | | | | | | | |
| (2WD) 430d, 435i, 440i M-Technik sus., Sport sus. Exc. M Performance | (F33) 10.13 - | | 3348028 | | | | 3448018 | | |
| SM9926 ³⁾ 910234 ¹⁾ 910236 ²⁾ | | | | | | | | | |
| (2WD) 420d, 430d, 435i, 440i M-Technik sus., Sport sus. M Performance | (F33) 10.13 - | | | | | | 3448018 | | |
| SM9926 ³⁾ 910234 ¹⁾ 910236 ²⁾ | | | | | | | | | |
| (4WD) 428i xDrive, 435i xDrive Incl. M Performance Exc. Sport sus., M-Technik sus., Adaptive sus. | (F33) 1.14 - | | 3348044 L 3348043 R | | | | 3448018 | | |
| SM9926 ³⁾ | | | | | | | | | |
| (4WD) 435d xDrive Exc. M-Technik sus., Adaptive sus. | (F33) 7.14 - | | 3348044 L 3348043 R | | | | | | |
| SM9926 ³⁾ | | | | | | | | | |
| (4WD) 430i xDrive, 440i xDrive Incl. M Performance | (F33) 3.16 - | | | | | | 3448018 | | |
| SM9926 ³⁾ | | | | | | | | | |
| 1) Sport sus. Exc. M-Technik sus., Adaptive sus., M Performance, (4WD) | | | | | | | | | |
| 2) Exc. M-Technik sus., Sport sus., Adaptive sus., M Performance, (4WD) | | | | | | | | | |
| 3) incl. Sport sus., M-Technik sus., M Performance, Adaptive sus. | | | | | | | | | |



| MODEL FAHRZEUG MODELE | YEAR JAHR ANNEE | FRONT/VORNE/AVANT | | | | REAR/HINTEN/ARRIERE | | | |
|--|-----------------------|-----------------------------|-----------------------------|--------------------------------|--|-----------------------------|-----------------------------|--------------------------------|--|
| | | PREMIUM Twin-tube Oil | EXCEL-G Twin-tube Gas | GAS-A-JUST Mono-tube Gas | | PREMIUM Twin-tube Oil | EXCEL-G Twin-tube Gas | GAS-A-JUST Mono-tube Gas | |
| BMW (D) | | | | | | | | | |
| 4 Series Gran Coupe (F36) | | | | | | | | | |
| (2WD) 418d (100 kW, 105 kW) 420d (kW : 120, 135, 147), 430d 420i (AT = N20B20B), 435i Incl. M Performance Exc. M-Technik sus. | (F36) | 3.14 - | | 3348027 | | | 3448017 | | |
| | | | | 910232 ¹⁾ | | | 910236 ¹⁾ | | |
| (2WD) 428i Exc. M-Technik sus. | (F36) | 3.14 - | | 3348027 | | | 3448018 | | |
| | | | | 910232 ¹⁾ | | | 910236 ¹⁾ | | |
| (2WD) 420d (140 kW), 418i, 440i (240 kW) Exc. Sport sus., Exc. M-Technik sus., Adaptive sus. | (F36) | 3.15 - | | 3348027 | | | | | |
| | | | | 910232 ¹⁾ | | | 910236 ¹⁾ | | |
| (2WD) 418d, 420d, 425d, 430d 418i, 420i, 428i, 430i, 435i, 440i Sport sus., M-Technik sus. Exc. , Adaptive sus. | (F36) | 3.14 - | | 3348028 | | | 3448018 | | |
| | | | | 910232 ¹⁾ | | | 910236 ¹⁾ | | |
| (2WD) 418d (110 kW), 420i (120 kW, 135 kW) M-Technik sus., Adaptive sus. Exc. Sport sus., | (F36) | 3.14 - | | 3348028 | | | 3448018 | | |
| | | | | 910232 ¹⁾ | | | 910236 ¹⁾ | | |
| (4WD) 430d xDrive Exc. , M-Technik sus., Adaptive sus. | (F36) | 7.14 - | | 3348044 L 3348043 R | | | 3448017 | | |
| | | | | | | | 910237 ²⁾ | | |
| (4WD) 435i xDrive, 435d xDrive Exc. , M-Technik sus., Adaptive sus. | (F36) | 7.14 - | | 3348044 L 3348043 R | | | 3448018 | | |
| | | | | | | | 910237 ²⁾ | | |
| (4WD) 420i xDrive (AT = B48B20A) 430i xDrive, 440i xDrive 420d xDrive (140 kW) Exc. , M-Technik sus., Adaptive sus. | (F36) | 7.15 - | | 3348044 L 3348043 R | | | | | |
| | | | | | | | 910237 ²⁾ | | |
| (4WD) 420i xDrive (AT = N20B20A), 428i xDrive 420d xDrive (kW : 120, 135, 147) Exc. , M-Technik sus., Adaptive sus. | (F36) | 3.14 - | | | | | 3448018 | | |
| | | | | | | | 910237 ²⁾ | | |
| (4WD) 420i xDrive (AT = N20B20B) Exc. , M-Technik sus., Adaptive sus. | (F36) | 3.14 - | | | | | | | |
| | | | | | | | 910237 ²⁾ | | |
| 1) Exc.Sport sus., , Adaptive sus., M Performance, | | | | | | | | | |
| 2) Exc. Sport sus., , M-Technik sus., M Performance, Adaptive sus. | | | | | | | | | |
| 3) incl. Sport sus., M-Technik sus., M Performance, Adaptive sus. | | | | | | | | | |
| 5 Series (E12) | | | | | | | | | |
| 518 | (E12) | 74- 76 | 665001 | | | | | | |
| 520 | | 72- 76 | | | | | | | |
| 520 | | 72- 76 | | | | | | | |
| 520i | | 72- 76 | | | | | | | |



BMW

| MODEL FAHRZEUG MODELE | YEAR JAHR ANNEE | FRONT/VORNE/AVANT | | | | REAR/HINTEN/ARRIERE | | | |
|--|-----------------------|--|-----------------------------|--------------------------------|--------|-----------------------------|-----------------------------|--------------------------------|--|
| | | PREMIUM Twin-tube Oil | EXCEL-G Twin-tube Gas | GAS-A-JUST Mono-tube Gas | | PREMIUM Twin-tube Oil | EXCEL-G Twin-tube Gas | GAS-A-JUST Mono-tube Gas | |
| BMW (D) | | | | | | | | | |
| 5 Series (E12) | | | | | | | | | |
| 518 4632974 → 520 4717726 → 520 4413737 → 520i 4454063 → | (E12) | 76 - 5.81 | 665001 | | | | | | |
| | | | 910084 | | | | | | |
| 520 (6 cyl.), 528 i | (E12) | 9.77 - 6.81 | | 365024 | | | | | |
| | | | 910084 | | | | | | |
| 525 4829406 → 525 4516704 → 528 4757067 → 528 4551948 → 530i 5012010 → 530i 5031674 → | (E12) | 73 - 7.76 | 665001 | | | | | | |
| | | | 910084 | | | | | | |
| 525 4829407 → 525 4516705 → 528 4757068 → 528 4551949 → 530i 5012011 → 530i 5031675 → | (E12) | 8.76 - 6.81 8.76 - 6.81 8.76 - 80 8.76 - 80 8.76 - 80 8.76 - 80 | 665001 | | | | | | |
| | | | 910084 | | | | | | |
| 5 Series (E28) | | | | | | | | | |
| 518, 518i, 524d 525i, 525e 525i ABS 525i ABS 524 TD | (E28) | 7.81 - 12.87 7.81 - 3.86 7.81 - 3.86 3.82 - 3.86 3.83 - 3.86 | | 365043 | | 441089 | | | |
| | | | 910084 | SM1000 | | | | | |
| 520i, 525e, 524td 525i ABS 525i ABS 528i, 535i | (E28) | 4.86 - 12.87 4.86 - 12.87 8.81 - 12.87 4.86 - 12.87 | | 365043 | | 341080 | | | |
| | | | 910084 | SM1000 | | | | | |
| 5 Series (E28) M5 | | | | | | | | | |
| | (E28) | 88 - 90 | | | | | | | |
| | | | | | SM1000 | | | | |
| 5 Series (E34) Exc. M-Technik sus., EDC , | | | | | | | | | |
| 518i, 520i Exc. Sport sus. | (E34) | 1.88 - 7.90 | | 365069 | | | 341081 | | |
| | | | 910084 | SM1000 | | 910006 | SM9005 | | |
| 518i, 520i Exc. Sport sus. | (E34) | 8.90 - 12.94 | | 365505 | | | 341081 | | |
| | | | 910084 | SM1000 | | 910006 | SM9005 | | |
| 518i, 520i Exc. Sport sus. | (E34) | 1.95 - 12.95 | | 365505 | | | 341081 | | |
| | | | 910084 | SM1000 | | 910006 | SM9005 | | |
| 518i, 520i Sport sus. | (E34) | 1.88 - 7.90 | | 366005 | | | 341081 | | |
| | | | | | | 910006 | SM9005 | | |
| 518i, 520i Sport sus. | (E34) | 8.90 - 9.92 | | 366007 | | | 341081 | | |
| | | | | | | 910006 | SM9005 | | |
| 518i, 520i Sport sus. | (E34) | 10.92 - 12.95 | | 365505 | | | 341081 | | |
| | | | | SM1000 | | 910006 | SM9005 | | |

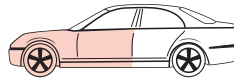

| MODEL FAHRZEUG MODELE | YEAR JAHR ANNEE | FRONT/VORNE/AVANT | | | | REAR/HINTEN/ARRIERE | | | |
|--|-----------------------|-----------------------------|-----------------------------|--------------------------------|--|-----------------------------|-----------------------------|--------------------------------|--|
| | | PREMIUM Twin-tube Oil | EXCEL-G Twin-tube Gas | GAS-A-JUST Mono-tube Gas | | PREMIUM Twin-tube Oil | EXCEL-G Twin-tube Gas | GAS-A-JUST Mono-tube Gas | |
| BMW (D) | | | | | | | | | |
| 5 Series (E34) Exc. M-Technik sus., EDC (⚡), | | | | | | | | | |
| 525i Incl. Sport sus. | (E34) | 11.87 - 7.90 | | 366005 | | | 341081 | | |
| | | | 910084 ¹⁾ SM1000 | | | 910006 SM9005 | | | |
| 525i Incl. Sport sus. | (E34) | 8.90 - 9.92 | | 366007 | | | 341081 | | |
| | | | 910084 ¹⁾ SM1000 | | | 910006 SM9005 | | | |
| 525i Incl. Sport sus. | (E34) | 10.92 - 12.95 | | 365505 | | | 341081 | | |
| | | | 910084 ¹⁾ SM1000 | | | 910006 SM9005 | | | |
| 525iX (4WD) Incl. Sport sus. | (E34) | 1.88 - 12.94 | | | | | 341081 | | |
| | | | SM1000 | | | 910006 SM9005 | | | |
| 530i, 535i, 524td Incl. Sport sus. | (E34) | 11.87 - 7.90 | | 366005 | | | 341081 | | |
| | | | 910084 ¹⁾ SM1000 | | | 910006 SM9005 | | | |
| 524td, 525tds 530i, 535i, 540i Incl. Sport sus. | (E34) | 8.90 - 9.92 8.90 - 12.95 | | 366007 | | | 341081 | | |
| | | | 910084 ¹⁾ SM1000 | | | 910006 SM9005 | | | |
| 525td, 525tds Incl. Sport sus. | (E34) | 10.92 - 12.95 | | 365505 | | | 341081 | | |
| | | | 910084 ¹⁾ SM1000 | | | 910006 SM9005 | | | |
| 1) Exc. Sport sus. | | | | | | | | | |
| 5 Series Touring (E34) Exc. M-Technik sus., EDC (⚡), | | | | | | | | | |
| 518i, 520i Exc. Sport sus. | (E34) | 91 - 12.94 | | 365505 | | | 341146 | | |
| | | | 910084 SM1000 | | | 910006 SM9005 | | | |
| 518i, 518d, 520i Exc. Sport sus. | (E34) | 1.95 - 9.97 | | 365505 | | | 341146 | | |
| | | | 910084 SM1000 | | | 910006 SM9005 | | | |
| 518i, 520i, 518d Sport sus. | (E34) | 91 - 3.97 | | 366007 | | | 341146 | | |
| | | | 910084 SM1000 | | | 910006 SM9005 | | | |
| 525td Exc. Sport sus. | (E34) | 91 - 3.97 | | 365505 | | | 341146 | | |
| | | | 910084 SM1000 | | | 910006 SM9005 | | | |
| 525td Sport sus. | (E34) | 91 - 3.97 | | 366007 | | | 341146 | | |
| | | | 910084 SM1000 | | | 910006 SM9005 | | | |
| 525tds Exc. Sport sus. | (E34) | 91 - 3.97 | | 366007 | | | 341146 | | |
| | | | 910084 | | | 910006 SM9005 | | | |
| 525i, 530i, 540i Incl. Sport sus. | (E34) | 91 - 3.97 | | 366007 | | | | | |
| | | | 910084 | | | | | | |
| 5 Series (E39) Exc. M-Technik sus., EDC (⚡), | | | | | | | | | |
| 520i, 523i, 525i, 528i, 530i 520d, 525d, 525td, 525tds, 530d Exc. Sport sus. | (E39) | 11.95 - 6.03 | | 335812 L 335811 R | | | 341840 | | |
| | | | 910005 SM1003 | | | SM5251 | | | |
| 535i, 540i Exc. Sport sus. | (E39) | 11.95 - 6.03 | | | | | 341840 | | |
| | | | 910005 SM1003 | | | SM5251 | | | |



| MODEL FAHRZEUG MODELE | YEAR JAHR ANNEE | FRONT/VORNE/AVANT | | | REAR/HINTEN/ARRIERE | | |
|---|-----------------------|-----------------------------|---|--------------------------------|-----------------------------|---|--------------------------------|
| | | PREMIUM Twin-tube Oil | EXCEL-G Twin-tube Gas | GAS-A-JUST Mono-tube Gas | PREMIUM Twin-tube Oil | EXCEL-G Twin-tube Gas | GAS-A-JUST Mono-tube Gas |
| BMW (D) | | | | | | | |
| 5 Series Touring (E39) Exc. M-Technik sus., EDC , | | | | | | | |
| 520i, 523i, 525i, 528i, 530i 520d, 525d, 525tds, 530d = Exc. Sport sus. | (E39) | 1.97 - 5.04 | | 335812 L 335811 R | | 344700 | |
| | | | 910005 SM1003 | | | SM9002 | |
| 520i, 523i, 525i, 528i, 530i 520d, 525d, 525tds, 530d = Exc. Sport sus. | (E39) | 1.97 - 5.04 | | 335812 L 335811 R | | 344701 | |
| | | | 910005 SM1003 | | | SM9002 | |
| 540i = Exc. Sport sus. | (E39) | 1.97 - 5.04 | | | | 344701 | |
| | | | 910005 SM1003 | | | SM9002 | |
| 5 Series (E60) Exc. , M-Technik sus. | | | | | | | |
| Exc. Sport sus. | (E60) | 7.03 - 3.10 | | 335816 L 335815 R | | 341704 | |
| | | | 910239 ¹⁾ SM1003 ²⁾ | | | 910122 ²⁾ SM5667 ²⁾ | |
| 1) Exc. M models 2) Incl. | | | | | | | |
| 5 Series Touring (E61) Exc. , M-Technik sus. | | | | | | | |
| Exc. Sport sus. | (E61) | 6.04 - | | 335818 L 335817 R | | 344702 | |
| | | | 910239 ¹⁾ SM1003 ²⁾ | | | 910122 ²⁾ SM5835 ²⁾ | |
| 1) Exc. M models 2) Incl. | | | | | | | |
| 5 Series Gran Turismo (F07) Exc. M-Technik sus. | | | | | | | |
| 530d, 535d, 535i, 550i Exc. Sport sus., , Adaptive sus. | (F07) | 1.09 - 2.17 | | 341733 L 341732 R | | 341734 | |
| | | | | | | SM9927 | |
| 520d, 528i Exc. Sport sus., , Adaptive sus. | (F07) | 4.11 - 2.17 | | | | 341734 | |
| | | | | | | SM9927 | |
| 530d xDrive, 535d xDrive 535i xDrive, 550i xDrive Exc. Sport sus., , Adaptive sus. | (F07) | 10.09 - 2.17 | | | | 341734 | |
| | | | | | | SM9927 | |
| 5 Series (F10, F18) Exc. | | | | | | | |
| 520i (120 kW, 135 kW), 523i, 528i 530i, 535i (225 kW) 520d (kW : 120, 135, 147) 525d, 530d, 535d Incl. Sport sus., M-Technik sus. Exc. Adaptive sus. | (F10, F18) | 1.09 - 10.16 | | 341707 L 341706 R | | 341710 | |
| | | | 910190 SM1004 ¹⁾ | | | 935314 SM9929 | |
| 1) Exc. 550i (330 kW) | | | | | | | |



| MODEL FAHRZEUG MODELE | YEAR JAHR ANNEE | FRONT/VORNE/AVANT | | | | REAR/HINTEN/ARRIERE | | | |
|--|-----------------------|-----------------------------|-----------------------------|--------------------------------|--|-----------------------------|-----------------------------|--------------------------------|--|
| | | PREMIUM Twin-tube Oil | EXCEL-G Twin-tube Gas | GAS-A-JUST Mono-tube Gas | | PREMIUM Twin-tube Oil | EXCEL-G Twin-tube Gas | GAS-A-JUST Mono-tube Gas | |
| BMW (D) | | | | | | | | | |
| 5 Series (F10, F18) Exc. | | | | | | | | | |
| (2WD) (F10, F18) 520i (125 kW), 535i (240 kW), 550i 518d, 520d (kW : 100, 140, 151, 155) ActiveHybrid Incl. Sport sus., M-Technic sus. Exc. Adaptive sus. | 1.09 - 10.16 | | | | | | 341710 | | |
| | | 910190 | SM1004 ¹⁾ | | | 935314 | SM9929 | | |
| (4WD) (F10, F18) Incl. Sport sus., M-Technic sus. Exc. Adaptive sus. | 8.10 - 10.16 | | | | | | 341710 | | |
| | | 910190 | SM1004 ¹⁾ | | | 935315 | SM9929 | | |
| 1) Exc. 550i (330 kW) | | | | | | | | | |
| 5 Series Touring (F11) | | | | | | | | | |
| (2WD) (F11) Incl. Sport sus. Exc. , M model | 11.09 - | | 341709 L 341708 R | | | | 341735 ¹⁾ | | |
| | | | SM1004 | | | 910196 | SM9927 | | |
| (4WD) (F11) Incl. Sport sus. Exc. , M model | 11.09 - | | | | | | 341735 | | |
| | | | | | | 910196 | SM9927 | | |
| 1) Exc. 550i (2WD) Sport sus. | | | | | | | | | |
| 6 Series (E24) | | | | | | | | | |
| 628CSi, 630CS, 633CSi (E24) | 76 - 6.78 | 665001 | | | | | | | |
| | | 910084 | | | | | | | |
| 628CSi, 630CS, 633CSi, 635CSi (E24) | 7.78 - 5.82 | | 365024 | | | | | | |
| | | 910084 | | | | | | | |
| 628CSi, 633CSi, 635CSi (E24) | 6.82 - 90 | | 365043 | | | 441089 | | | |
| | | 910084 | SM1000 | | | | | | |
| 630CSi (E24) | 6.82 - 90 | | 365043 | | | 441089 | | | |
| | | 910084 | | | | | | | |
| 6 Series (E24) M6 | | | | | | | | | |
| (E24) | 86 - 90 | | | | | | | | |
| | | | SM1000 | | | | | | |
| 6 Series (E63) Exc. | | | | | | | | | |
| (E63) | 9.03 - | | | | | | | | |
| | | | SM1003 | | | | SM5667 | | |
| 6 Series (E64) Exc. | | | | | | | | | |
| (E64) | 4.04 - | | | | | | | | |
| | | | SM1003 | | | | SM5667 | | |
| 6 Series Gran Coupé (F06) Exc. | | | | | | | | | |
| (F06) Exc. M model | 9.11 - | | | | | | | | |
| | | 910190 | SM1004 | | | | | | |



BMW

| MODEL FAHRZEUG MODELE | YEAR JAHR ANNEE | FRONT/VORNE/AVANT | | | | REAR/HINTEN/ARRIERE | | | |
|--|-----------------------|-----------------------------|-----------------------------|--------------------------------|--|-----------------------------|-----------------------------|--------------------------------|--|
| | | PREMIUM Twin-tube Oil | EXCEL-G Twin-tube Gas | GAS-A-JUST Mono-tube Gas | | PREMIUM Twin-tube Oil | EXCEL-G Twin-tube Gas | GAS-A-JUST Mono-tube Gas | |
| BMW (D) | | | | | | | | | |
| 6 Series (F12) Exc. | | | | | | | | | |
| (2WD) 640i, 650i 640d Exc. M model | (F12) | 3.11 - 9.11 - | | 341709 L 341708 R | | | 341711 | | |
| | | | 910190 | | | | SM9929 | | |
| (4WD) 640i xDrive, 650i xDrive, 640d xDrive Exc. M model | (F12) | 6.11 - | | | | | | | |
| | | | 910190 | | | | SM9929 | | |
| 6 Series (F13) Exc. | | | | | | | | | |
| (2WD) 640i, 650i, 640d Exc. M model | (F13) | 6.11 - | | 341709 L 341708 R | | | 341711 | | |
| | | | | | | | SM9929 | | |
| (4WD) 640i xDrive, 650i xDrive, 640d xDrive Exc. M model | (F13) | 6.11 - | | | | | | | |
| | | | | | | | SM9929 | | |
| 7 Series (E23) | | | | | | | | | |
| 728, 728i, 730, 733i → 3035000 | (E23) | 77 - 8.79 | | 365024 | | | | | |
| | | | 910084 | | | | | | |
| 728i, 732i, 735i 3035001 → | (E23) | 9.79 - 9.81 | | 365024 | | | | | |
| | | | 910084 | | | | | | |
| 728i, 732i, 735i | (E23) | 10.81 - 8.84 | | 365024 | | | | | |
| | | | 910084 | | | | | | |
| 745i | (E23) | 7.79 - 8.84 | | 365024 | | | | | |
| | | | 910084 | | | | | | |
| 728i, 732i, 735i | (E23) | 9.84 - 8.86 | | 365024 | | | | | |
| | | | 910084 | | | | | | |
| 745i | (E23) | 9.84 - 8.86 | | 365024 | | | | | |
| | | | 910084 | | | | | | |
| 7 Series (E32) Exc. M-Technik sus., EDC | | | | | | | | | |
| 730i, 730iL, 735i, 735iL Incl. Sport sus. | (E32) | 9.86 - 2.88 | | 365082 | | | 341129 | | |
| | | | 910084 | | | | Exc. 910006 SM9006 | | |
| 730i, 730iL, 735i, 735iL Incl. Sport sus. | (E32) | 3.88 - 7.90 | | 366005 | | | 341129 | | |
| | | | 910084 | | | | Exc. 910006 SM9006 | | |
| 730i, 730iL 735i, 735iL Incl. Sport sus. | (E32) | 8.90 - 1.92 8.90 - 94 | | 366007 | | | 341129 | | |
| | | | 910084 | | | | Exc. 910006 SM9006 | | |



| MODEL FAHRZEUG MODELE | YEAR JAHR ANNEE | FRONT/VORNE/AVANT | | | | REAR/HINTEN/ARRIERE | | | |
|---|-----------------------|--|-----------------------------|---|--|-----------------------------|---|--------------------------------|--|
| | | PREMIUM Twin-tube Oil | EXCEL-G Twin-tube Gas | GAS-A-JUST Mono-tube Gas | | PREMIUM Twin-tube Oil | EXCEL-G Twin-tube Gas | GAS-A-JUST Mono-tube Gas | |
| BMW (D) | | | | | | | | | |
| 7 Series (E38) Exc. M-Technik sus., EDC | | | | | | | | | |
| 725tds, 728i, 730i, 740i Exc. | (E38) | 4.94 - 01 | | | | | 341211 | | |
| | | | | SM5252 | | | Exc. | SM9004 | |
| | (E38) | 4.94 - 01 | | | | | 341211 | | |
| 725tds, 728i, 730i, 740i | | | | SM5252 | | | Exc. | SM9004 | |
| 728iL, 730iL, 740iL, 750iL | (E38) | 4.94 - 01 | | | | | | | |
| | | | | SM5252 | | | | | |
| 7 Series (E65, E66) | | | | | | | | | |
| | (E65, E66) | 11.01 - 10.08 | | | | | | | |
| | | | | | | | | SM5667 | |
| E 10 Series | | | | | | | | | |
| 1502 1600-2 Ti 2002 Ti 1602, 1802, 2000 Tii, 2002 Tii Touring 1600, 1800, 2000 Touring 1602, 1802, 2002 | (E10) | 75 - 77 66 - 71 67 - 75 71 - 75 71 - 75 71 - 75 | 663001 | | | 443004 | | | |
| | | | | SM1002 | | | | | |
| Series 2.5, 2.8, 3.0, 3.3 (E3) | | | | | | | | | |
| 2500, 2500 A, 2.8i, 2.8 LA 3.0 S, 3.0 SA, 3.0 Si, 3.0 SiA 3.0 L, 3.0 LA, 3.3 L, 3.3 LA | (E3) | 9.75 - 76 | | 365024 | | | | | |
| | | | | | | | | | |
| X1 | | | | | | | | | |
| (E84) sDrive 16i, sDrive 18i, sDrive 20i sDrive 18d, sDrive 20d (120 kW, 130 kW) Incl. Sport sus. Exc. Efficient Dynamics | (E84) | 3.09 - | | 3358002 L 3358001 R | | | 349200 | | |
| | | | | 910238 ¹⁾ SM1003 910239 ²⁾ | | | 910194 ¹⁾ SM9008▼ 910193 ²⁾ SM5752 | | |
| (E84) sDrive 16d, sDrive 20d (135 kW) Incl. Sport sus. | (E84) | 4.12 - | | | | | 349200 | | |
| | | | | 910238 ¹⁾ SM1003 910239 ²⁾ | | | 910194 ¹⁾ SM9008▼ 910193 ²⁾ SM5752 | | |
| (E84) xDrive 20i, xDrive 25i, xDrive 28i xDrive 18d, xDrive 20d, xDrive 23d xDrive 25d Incl. Sport sus. | (E84) | 3.09 - | | 3358004 L 3358003 R | | | 349200 | | |
| | | | | 910240 SM1003 | | | 910194 ¹⁾ SM9008▼ 910193 ²⁾ SM5752 | | |
| (F48) Exc. sDrive 28i, ActiveFlex, Hybrid Exc. Sport sus., M-Technik sus., | (F48) | 11.14 - | | 3348101 L◇ 3348100 R◇ | | | 3448034 | | |
| | | | | 910233 | | | SM9926 | | |
| (F48) Sport sus., M-Technik sus. Exc. sDrive 28i, ActiveFlex, Hybrid, | (F48) | 11.14 - | | 3348101 L◇ 3348100 R◇ | | | 3448034 | | |
| | | | | 910231 | | | SM9926 | | |

1) Exc. Sport sus

2) Sport sus



BMW

| MODEL FAHRZEUG MODELE | YEAR JAHR ANNEE | FRONT/VORNE/AVANT | | | | REAR/HINTEN/ARRIERE | | | |
|---|-----------------------|-----------------------------|-----------------------------|--|--|-----------------------------|-----------------------------|--------------------------------|--|
| | | PREMIUM Twin-tube Oil | EXCEL-G Twin-tube Gas | GAS-A-JUST Mono-tube Gas | | PREMIUM Twin-tube Oil | EXCEL-G Twin-tube Gas | GAS-A-JUST Mono-tube Gas | |
| BMW (D) | | | | | | | | | |
| X2 | | | | | | | | | |
| Incl. Sport sus., M-Technik sus. Exc. 28i, ActiveFlex, Hybrid, | (F39) | 11.17 - | | | | | 3448034 | | |
| Hybrid | (F39) | 3.20 - | | 3348101 L 3348100 R | | | 3448034 | | |
| X3 | | | | | | | | | |
| Incl. xDrive, Sport sus. | (E83) | 1.03 - | | 335834 L 335833 R 910241 ¹⁾ | | | 344487 | | |
| | (F25) | 9.10 - | | 910242 | | | | | |
| 1) Exc. , Sport sus. | | | | | | | | | |
| X4 | | | | | | | | | |
| | (F26) | 5.13 - | | 910242 | | | | | |
| X5 (E53) | | | | | | | | | |
| 3.0i, 4.4i, 4.6is 3.0d Exc. Sport sus. | (E53) | 5.00 - 07 | | 335925 L 335924 R 910218 | | | | 555608 | |
| 910192 | | | | | | | | | |
| X5 (E70) | | | | | | | | | |
| 3.0d, 3.0sd, 3.0si xDrive 30d, xDrive 35d, xDrive 40d, xDrive 30i, xDrive 35i, xDrive 50i Incl. Sport sus. Exc. , M model | (E70) | 2.06 - | | 339787 910187 | | | 341728 L 341727 R | | |
| 3.0d, 3.0sd, 3.0si, 4.8i xDrive 30d, xDrive 35d, xDrive 40d, xDrive 30i, xDrive 35i, xDrive 48i, xDrive 50i Incl. Sport sus, 3rd seat row Exc. M model | (E70) | 2.06 - | | 910188 | | | 341730 L 341729 R | | |
| M 50d | (E70) | 8.11 - | | 339787 | | | 341730 L 341729 R | | |
| X5 (F15) | | | | | | | | | |
| Incl. 3rd seat row Exc. M model, Hybrid, Comfort sus. Exc. , M-Technics, Adaptive sus. | (F15) | 8.13 - 7.18 | | 3418001 | | | 3418003 L 3418002 R | | |



| MODEL FAHRZEUG MODELE | YEAR JAHR ANNEE | FRONT/VORNE/AVANT | | | | REAR/HINTEN/ARRIERE | | | |
|---|-----------------------|-----------------------------|-----------------------------|--------------------------------|--|-----------------------------|-----------------------------|--------------------------------|--|
| | | PREMIUM Twin-tube Oil | EXCEL-G Twin-tube Gas | GAS-A-JUST Mono-tube Gas | | PREMIUM Twin-tube Oil | EXCEL-G Twin-tube Gas | GAS-A-JUST Mono-tube Gas | |
| BMW (D) | | | | | | | | | |
| X5 (F15) | | | | | | | | | |
| xDrive 35i xDrive 25d, xDrive 30d, xDrive 40d ⊕ Adaptive sus. Exc. Comfort sus., M-Technics, | (F15) | 8.13 - 7.18 | | | | | | 3418003 L 3418002 R | |
| xDrive 50i ⊕ Adaptive sus. Exc. Comfort sus., M-Technics, | (F15) | 8.13 - 7.18 | | 3418001 | | | | 3418003 L 3418002 R | |
| X6 (E71, E72) | | | | | | | | | |
| 50i, xDrive 50i | (E71, E72) | 6.07 - | | 339787 | | | | | |
| | | | | SM1033 | | | | SM5810 | |
| 30d, 35d, 35i, 50i xDrive 30d, xDrive 35d, xDrive 40d, xDrive 35i, xDrive 50i ⊕ | (E71, E72) | 6.07 - | | | | | | 341730 L 341729 R | |
| | | | | 910188 SM1033 | | | | SM5810 | |
| X6 (F16) | | | | | | | | | |
| Incl. 3rd seat row Exc. M model, Comfort sus., Exc. M-Technics, Adaptive sus. | (F16) | 8.14 - | | 3418001 | | | | 3418003 L 3418002 R | |
| xDrive 35i xDrive 30d, xDrive 40d ⊕ Adaptive sus. Exc. Comfort sus., M-Technics, | (F16) | 8.14 - | | | | | | 3418003 L 3418002 R | |
| xDrive 50i ⊕ Adaptive sus. Exc. Comfort sus., M-Technics, | (F16) | 8.14 - | | 3418001 | | | | 3418003 L 3418002 R | |
| Z1 | | | | | | | | | |
| | | 10.88 - 2.91 | | | | | | | |
| | | | | SM1000 | | | | SM9000 | |
| Z3 Exc. M-Technik sus. | | | | | | | | | |
| 1.8, 1.9, 2.0, 2.2, 2.8 Exc. Sport sus. | (E36) | 10.95 - 1.03 | | 334605 L 334604 R | | | | 343330 | |
| | | | | 910186 SM1001 | | | | SM9000 | |
| 3.0 M3.2 | | 6.00 - 3.97 - 6.01 | | | | | | | |
| | | | | SM1001 | | | | SM9000 | |
| Z4 | | | | | | | | | |
| | | 03 - 07 | | | | | | | |
| | | | | 910084 SM1001 | | | | SM9000 | |
| Z4 Roadster | | | | | | | | | |
| sDrive 18i, sDrive 20i, sDrive 23i, sDrive 28i, sDrive 30i (190 kW), sDrive 35i, sDrive 35is (250 kW) | (E89) | 5.09 - | | | | | | | |
| | | | | SM1028 | | | | | |



Chevrolet

| MODEL FAHRZEUG MODELE | YEAR JAHR ANNEE | FRONT/VORNE/AVANT | | | | REAR/HINTEN/ARRIERE | | | |
|-----------------------------|-----------------------|-----------------------------|-----------------------------|--------------------------------|--|-----------------------------|-----------------------------|--------------------------------|--|
| | | PREMIUM Twin-tube Oil | EXCEL-G Twin-tube Gas | GAS-A-JUST Mono-tube Gas | | PREMIUM Twin-tube Oil | EXCEL-G Twin-tube Gas | GAS-A-JUST Mono-tube Gas | |

Buick (US) → General Motors (US)

Chevrolet - Daewoo (KO)

Aveo

| | | | | | | | | |
|---|---------|------------|------------------------|--|--|------------|--|--|
| 1.2, 1.4 (74 kW) (T300) 1.3 D (55 kW), 1.3 D (70 kW) ⊕ ⊗ 6-speed Exc. Sport sus. | 3.11 - | | 3330040 L 3330039 R | | | 343459 | | |
| | | ☞☞☞ 910316 | | | | ☞☞☞ 910223 | | |
| 1.2 LPG (T300) Exc. Sport sus. | 11.12 - | | | | | | | |
| | | ☞☞☞ 910316 | | | | ☞☞☞ 910223 | | |
| 1.4 Turbo (T300) | 8.13 - | | 3330040 L 3330039 R | | | | | |
| | | | | | | ☞☞☞ 910223 | | |
| 1.6 (85 kW) (T300) Exc. Sport sus. | 3.11 - | | 3330040 L 3330039 R | | | 349228 | | |
| | | ☞☞☞ 910316 | | | | ☞☞☞ 910223 | | |
| 1.3 D (70 kW) ⊕ ⊗ 5-speed (T300) Exc. Sport sus. | 7.11 - | | 3330040 L 3330039 R | | | | | |
| | | ☞☞☞ 910316 | | | | ☞☞☞ 910223 | | |
| 1.2, 1.4 (74 kW) ⊕ Sport sus. (T300) | 3.11 - | | 3330042 L 3330041 R | | | 343459 | | |
| | | ☞☞☞ 910327 | | | | ☞☞☞ 910223 | | |
| 1.2 LPG ⊕ Sport sus. (T300) | 11.12 - | | | | | | | |
| | | ☞☞☞ 910327 | | | | ☞☞☞ 910223 | | |
| 1.6 (85 kW), 1.3 D ⊕ Sport sus. (T300) | 3.11 - | | 3330042 L 3330041 R | | | 349228 | | |
| | | ☞☞☞ 910327 | | | | ☞☞☞ 910223 | | |

Captiva

| | | | | | | | | |
|---|---------|------------|----------------------|--|--|--------|--|--|
| <u>2WD</u> <u>4WD</u> (C100, C400) 2.4 (100 kW), 2.4 LPG, 3.2 2.0 D (93 kW, 110 kW) | 6.06 - | | 335845 L 335844 R | | | 345084 | | |
| | | ☞☞☞ 910285 | | | | Exc. | | |
| <u>2WD</u> <u>4WD</u> (C100, C400) 2.4 (123 kW), 2.0 D (120 kW) | 1.11 - | | | | | 345084 | | |
| | | ☞☞☞ 910285 | | | | Exc. | | |
| <u>2WD</u> <u>4WD</u> (C100, C400) 3.0, 2.2 D | 11.10 - | | | | | | | |
| | | ☞☞☞ 910285 | | | | | | |

Cobalt II

| | | | | | | | | |
|-------------------------|--------|------------|------------------------|--|--|--|--|--|
| 1.5 <u>2WD</u> ⊕ ⊗ (69) | 1.13 - | | 3330042 L 3330041 R | | | | | |
| | | ☞☞☞ 910327 | | | | | | |

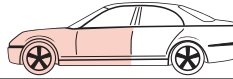

| MODEL FAHRZEUG MODELE | YEAR JAHR ANNEE | FRONT/VORNE/AVANT | | | | REAR/HINTEN/ARRIERE | | | | | | | | | |
|--|-----------------------|--|-----------------------------|--------------------------------|--|-----------------------------|-----------------------------|--------------------------------|--|--------------|--------|-------------------|--------|--------------|---------|
| | | PREMIUM Twin-tube Oil | EXCEL-G Twin-tube Gas | GAS-A-JUST Mono-tube Gas | | PREMIUM Twin-tube Oil | EXCEL-G Twin-tube Gas | GAS-A-JUST Mono-tube Gas | | | | | | | |
| Chevrolet - Daewoo (KO) | | | | | | | | | | | | | | | |
| Cruze (J300) | | | | | | | | | | | | | | | |
| 1.6 (80 kW, 91 kW) 1.6 (83 kW) 1.8, 1.8 LPG | (J300) | 5.09 - 4.12 5.09 - 5.09 - 4.12 | | 339382 L 339381 R | | | 348032 ¹⁾ | | | | | | | | |
| | | | 910222 ²⁾ | SM5729▼ SM1008 | | 910205 | | | | | | | | | |
| 1.4, 1.6 (86 kW) 1.6 (80 kW, 91 kW) 1.7 D, 1.7 TD 1.8, 1.8 LPG 2.0 CDi (kW : 92, 110, 120) | (J300) | 9.10 - 5.12 - 1.12 - 5.12 - 5.09 - | | 339419 L 339418 R | | | 348032 ¹⁾ | | | | | | | | |
| | | | 910222 ²⁾ | SM5729▼ SM1008 | | 910205 | | | | | | | | | |
| 1) Exc. CE = p/n 13412142 2) 11.12 → | | | | | | | | | | | | | | | |
| Cruze (J305) | | | | | | | | | | | | | | | |
| 1.6 (80 kW, 91 kW) 1.8, 1.8 LPG | (J305) | 6.11 - 4.12 | | 339382 L 339381 R | | | 348032 ¹⁾ | | | | | | | | |
| | | | 910222 ²⁾ | SM5729▼ SM1008 | | 910205 | | | | | | | | | |
| 1.4, 1.6 (86 kW) 1.6 (80 kW, 91 kW) 1.7 D, 1.7 TD 1.8, 1.8 LPG 2.0 CDi | (J305) | 6.12 - 5.12 - 1.12 - 5.12 - 6.11 - | | 339419 L 339418 R | | | 348032 ¹⁾ | | | | | | | | |
| | | | 910222 ²⁾ | SM5729▼ SM1008 | | 910205 | | | | | | | | | |
| 1) Exc. 2) 10.12 → | | | | | | | | | | | | | | | |
| Cruze Station Wagon (J308) | | | | | | | | | | | | | | | |
| | (J308) | 8.12 - | | 339419 L 339418 R | | | 348032 | | | | | | | | |
| | | | 910222 ¹⁾ | SM5729▼ SM1008 | | 910205 | | | | | | | | | |
| 1) | | | | | | | | | | | | | | | |
| Epica | | | | | | | | | | | | | | | |
| 1.8, 2.0, 2.0 D, 2.5 | (KL1) | 1.05 - | | 339791 L 339790 R | | | 341737 L 341731 R | | | | | | | | |
| | | | | SM1039 | | | SM5795 ¹⁾ ▼ | | | | | | | | |
| 1) <table border="1"> <tr><td>2.0 (105 kW)</td><td>→ 7.09</td></tr> <tr><td>2.0 TDCi (110 kW)</td><td>→ 7.09</td></tr> <tr><td>2.5 (115 kW)</td><td>→ 12.09</td></tr> </table> | | | | | | | | | | 2.0 (105 kW) | → 7.09 | 2.0 TDCi (110 kW) | → 7.09 | 2.5 (115 kW) | → 12.09 |
| 2.0 (105 kW) | → 7.09 | | | | | | | | | | | | | | |
| 2.0 TDCi (110 kW) | → 7.09 | | | | | | | | | | | | | | |
| 2.5 (115 kW) | → 12.09 | | | | | | | | | | | | | | |



Chevrolet

| MODEL FAHRZEUG MODELE | YEAR JAHR ANNEE | FRONT/VORNE/AVANT | | | | REAR/HINTEN/ARRIERE | | | |
|---|----------------------------|-----------------------------|--|--------------------------------|--|-----------------------------|-----------------------------|--------------------------------|--|
| | | PREMIUM Twin-tube Oil | EXCEL-G Twin-tube Gas | GAS-A-JUST Mono-tube Gas | | PREMIUM Twin-tube Oil | EXCEL-G Twin-tube Gas | GAS-A-JUST Mono-tube Gas | |
| Chevrolet - Daewoo (KO) | | | | | | | | | |
| Espero / Aranos | | | | | | | | | |
| (KLEJ) | 10.91 - 9.99 | 665036 | 365501 375009 | | | 443134 | 343047 | 553075▼ 243014 | |
| | | 910083 | SM1307▼ | | | | | | |
| Kalos / Aveo | | | | | | | | | |
| 1.2 i, 1.2 LPG, 1.4 i, 1.5 i (KLAS, T2_) | 9.02 - 12.10 | | 333418 L 333417 R | | | 443399 | 343423 | | |
| | | 910010 | SM5451 | | | 915400 | SM5452 | | |
| Lacetti / Optra / Gentra | | | | | | | | | |
| 1.4, 1.6, 1.8, 2.0 D (KLAN, J200) | 2.04 - | | 339030 L 339029 R | | | | 333420 L 333419 R | | |
| | | 910063 | SM5721 | | | 910065 | SM9010 | | |
| Lanos / Sens | | | | | | | | | |
| (KLAT) | 5.97 - | 665036 | 365501 375009 | | | 443134 | 343047 | 553075▼ 243014 | |
| | | 910083 | SM1020 L SM1021 R | | | | | | |
| Leganza | | | | | | | | | |
| 2.0 16V, 2.2 16V Incl. ABS (KLAV) | 6.97 - 4.04 | 634096 L 634095 R | | | | 634098 L 634097 R | 334214 L▼ 334213 R▼ | | |
| Matiz / Spark | | | | | | | | | |
| 0.8 (M100, M150, KYLA) 1.0 Incl. ABS | 9.98 - 3.05 1.03 - 3.05 | 632117 L 632116 R | 332101 L 332100 R | | | 443301 | 343304 | | |
| | | 910083 | | | | | | | |
| 0.8, 0.8 LPG (M200, M250) 1.0, 1.0 LPG | 3.05 - 12.08 | | 332505 L▼ 332504 R▼ 3320036 L 3320035 R | | | | 343478 | | |
| | | SM5451 | | | | | | | |
| (M300) | 3.10 - | | 3330080 L 3330079 R | | | | 348036 | | |
| | | SM1054 | | | | SM5843 | | | |
| Matiz (UzDaewoo) | | | | | | | | | |
| 0.8, 1.0 Incl. ABS (M150) | 8.01 - | 632117 L 632116 R | 332101 L 332100 R | | | 443301 | 343304 | | |
| | | 910083 | | | | | | | |
| Musso → SsangYong | | | | | | | | | |



| MODEL FAHRZEUG MODELE | YEAR JAHR ANNEE | FRONT/VORNE/AVANT | | | Wrench icon | REAR/HINTEN/ARRIERE | | | Wrench icon |
|---|-----------------------|-----------------------------|-----------------------------|--------------------------------|-------------|-----------------------------|--|--------------------------------|-------------|
| | | PREMIUM Twin-tube Oil | EXCEL-G Twin-tube Gas | GAS-A-JUST Mono-tube Gas | | PREMIUM Twin-tube Oil | EXCEL-G Twin-tube Gas | GAS-A-JUST Mono-tube Gas | |
| Chevrolet - Daewoo (KO) | | | | | | | | | |
| Nexia / Cielo | | | | | | | | | |
| (KLETN) Incl. Nexia II (UzDaewoo) | 2.95 - 3.01 | 665036 | 365501 375009 | | | 443134 | 343047 | 553075▼ 243014 | |
| 910083 SM1307▼ | | | | | | | | | |
| Nubira | | | | | | | | | |
| 1.6 16V, 2.0 16V KLAJ ****EV Incl. ABS | (KLAJ) 97 - 7.97 | 634092 L▼ 634091 R▼ | 334208 L▼ 334207 R▼ | | | 633203 L 633202 R | 333255 L 333254 R | | |
| 1.6 16V, 1.8, 2.0 16V KLAJ ****EW,EX,EY,... Incl. ABS | (KLAJ) 8.97 - 5.99 | | 334210 L 334209 R | | | 633203 L 633202 R | 333255 L 333254 R | | |
| Nubira II | | | | | | | | | |
| 1.6 16V, 2.0 16V Incl. ABS | (KLAJ) 6.99 - 6.03 | | 334210 L 334209 R | | | 633203 L 633202 R | 333255 L 333254 R | | |
| Nubira III | | | | | | | | | |
| 1.4, 1.6, 1.8 Incl. ABS | (KLAN) 7.03 - | | 339030 L 339029 R | | | | 333420 L ¹⁾ 333419 R ¹⁾ | | |
| 910063 SM5721 910065 SM9010 | | | | | | | | | |
| 1) : →12.04 | | | | | | | | | |
| Rezzo / Tacuma | | | | | | | | | |
| 1.6i, 1.8i, 2.0i | (KLAU) 4.00 - | | | | | | | 553339 | |
| MB1901 | | | | | | | | | |
| Tico | | | | | | | | | |
| (KLY3) | 96 - | 632094 L 632093 R | | | | | 342018 | | |
| Trax | | | | | | | | | |
| | 12.12 - | | 3340214 L 3340213 R | | | | 3440008▼ 3440035 | | |
| 912049 ¹⁾ 912048 ²⁾ | | | | | | | | | |
| 1) : 12.12 → 2) 1.4, 1.8: →12.12 1.4, 1.8: 1.18 → 1.6 D, 1.7 TD: 12.12 → | | | | | | | | | |
| Chevrolet (US) → General Motors (US) | | | | | | | | | |
| Chrysler - Dodge - Plymouth (US) | | | | | | | | | |
| 300C | | | | | | | | | |
| 2.7, 3.5, 3.0 CRD, 3.0 V6 Exc. , | 9.04 - 12.10 | | 341609 L 341608 R | | | | 349065 | | |
| SM1040 ¹⁾ | | | | | | | | | |
| 1) → 12.09 | | | | | | | | | |



Chrysler

| MODEL FAHRZEUG MODELE | YEAR JAHR ANNEE | FRONT/VORNE/AVANT | | | | REAR/HINTEN/ARRIERE | | | |
|--|-----------------------|-----------------------------|-----------------------------|--------------------------------|--|-----------------------------|-----------------------------|--------------------------------|--|
| | | PREMIUM Twin-tube Oil | EXCEL-G Twin-tube Gas | GAS-A-JUST Mono-tube Gas | | PREMIUM Twin-tube Oil | EXCEL-G Twin-tube Gas | GAS-A-JUST Mono-tube Gas | |
| Chrysler - Dodge - Plymouth (US) | | | | | | | | | |
| 300C | | | | | | | | | |
| 2.7, 3.5, 5.7, 3.0 CRD Exc. , | 9.04 - 12.10 | | 341609 L 341608 R | | | 349065 | | | |
| SM1040 ¹⁾ | | | | | | | | | |
| 1) → 12.09 | | | | | | | | | |
| Caliber | | | | | | | | | |
| 1.8, 2.0, 2.0 CRD, 2.2 CRD 2.4, 2.4 Turbo , SXT Exc. SRT4 | 6.06 - | | 334643 L 334642 R | | | 340076 | | | |
| SM5601 | | | | | | | | | |
| 2.4 SRT4 | 10.06 - | | | | | | | | |
| SM5601 | | | | | | | | | |
| Crossfire | | | | | | | | | |
| 3.2 i V6 18V 3.2 Auto V6 18V SRT-6 3.2 i Auto V6 18V | 7.03 - | | | 553363 | | | | 553364 | |
| Journey | | | | | | | | | |
| | 6.08 - | | 339250 L 339249 R | | | | | | |
| Le Baron, Saratoga | | | | | | | | | |
| Incl. GTS, GTC Exc. | 86 - 95 | | 235902 | | | 343164 | | | |
| Neon | | | | | | | | | |
| Exc. Sport sus. | 95 - 99 | | 234902 | | | 234901 | | | |
| SM5135▼ | | | | | | | | | |
| | 00 - 05 | | 235627 | | | 235629 L 235628 R | | | |
| SM5199 SM5198 | | | | | | | | | |
| PT-Cruiser | | | | | | | | | |
| | 01 - | | 235626 | | | 343385 | 553333 | | |
| SM5199 | | | | | | | | | |
| Sebring | | | | | | | | | |
| | 95 - 96 | | | | | | | | |
| SM5262 SM5137 | | | | | | | | | |
| | 97 - 00 | | | | | | | | |
| SM5262 | | | | | | | | | |
| | 01 - 06 | | | | | | | | |
| SM5263 | | | | | | | | | |



| MODEL FAHRZEUG MODELE | YEAR JAHR ANNEE | FRONT/VORNE/AVANT | | | | REAR/HINTEN/ARRIERE | | | |
|---|---|-----------------------------|-----------------------------|--------------------------------|--|-----------------------------|-----------------------------|--------------------------------|--|
| | | PREMIUM Twin-tube Oil | EXCEL-G Twin-tube Gas | GAS-A-JUST Mono-tube Gas | | PREMIUM Twin-tube Oil | EXCEL-G Twin-tube Gas | GAS-A-JUST Mono-tube Gas | |
| Chrysler - Dodge - Plymouth (US) | | | | | | | | | |
| Sebring | | | | | | | | | |
| | 95 - 00 | | | | | | | | |
| | | | | | | | | | |
| | 01 - 05 | | | | | | | | |
| Sebring | | | | | | | | | |
| | 01 - 06 | | | | | | | | |
| 2.0 (115 kW) 2.7 (137 kW) 3.5 (175 kW) Exc. Incl. Sport sus. | (JS) 7.07 - 5.11 7.07 - 9.10 7.07 - 9.10 | | 339248 L 339247 R | | | | 340068 | | |
| 2.0 (103 kW) 2.4 (128 kW) Exc. Incl. Sport sus. | (JS) 7.07 - 9.10 10.06 - 12.10 | | 339248 L 339247 R | | | | 340068 ¹⁾ | | |
| 1) Exc. | | | | | | | | | |
| Stratus, Cirrus, Breeze | | | | | | | | | |
| | 95 - 98 | | 344609 | | | | 344610 | | |
| | | | | | | | | | |
| | 99 - 00 | | 344609 | | | | 344610 | | |
| | | | | | | | | | |
| Stratus | | | | | | | | | |
| | 01 - 05 | | | | | | | | |
| Voyager / Mini-Van, Town & Country, Caravan | | | | | | | | | |
| Voyager I | (AS) 8.84 - 9.90 | | | | | | 344080 | | |
| Voyager II Incl. Grand Voyager, Grand Caravan | (ES) 8.90 - 9.95 | | 235901 | | | | 344080 | | |
| | | | | | | | | | |
| | | | | | | | | | |
| | | | | | | | | | |
| | | | | | | | | | |
| Voyager III Incl. Grand Voyager, Grand Caravan Exc. | (GS) 2.95 - 3.01 | | 334188 | | | | 344080 ²⁾ | | |
| | | | | | | | | | |
| | | | | | | | | | |
| | | | | | | | | | |
| | | | | | | | | | |
| Voyager IV Incl. Grand Voyager, Grand Caravan Exc. | (RG) 2.00 - 12.08 | | 334335 | | | | 344080 ²⁾ | | |
| | | | | | | | | | |
| | | | | | | | | | |
| | | | | | | | | | |
| Voyager V/Grand Voyager V | (RT) 10.07 - | | 339271 | | | | 349117 | | |
| | | | | | | | | | |
| 1) Incl. 2) Exc. | | | | | | | | | |



Citroën

| MODEL FAHRZEUG MODELE | YEAR JAHR ANNEE | FRONT/VORNE/AVANT | | | | REAR/HINTEN/ARRIERE | | | |
|-----------------------------|-----------------------|-----------------------------|-----------------------------|--------------------------------|--|-----------------------------|-----------------------------|--------------------------------|--|
| | | PREMIUM Twin-tube Oil | EXCEL-G Twin-tube Gas | GAS-A-JUST Mono-tube Gas | | PREMIUM Twin-tube Oil | EXCEL-G Twin-tube Gas | GAS-A-JUST Mono-tube Gas | |

Chrysler - Dodge - Plymouth (US)

Ypsilon

| | | | | | | | | | |
|----------------------------------|-------------|----------------------|------------------------|--|--|--|--------|--|--|
| 0.9 Twinair, 1.2 1.3 Multijet | 5.11 - 8.12 | | 3348006 L 3348005 R | | | | 348035 | | |
| | | SM1820 ¹⁾ | | | | | | | |

1) 5.11 →

Citroën (F)

2CV, Dyane, Mehari Exc. Acadiane

| | | | | | | | | | |
|--|---|--------|--|--|--|--------|--|--|--|
| 2 CV AZU 250 GA Dyane 4, Dyane 6 Mehari (2WD) Dyane Mehari Piste | 66 - 6.75 3.70 - 6.75 66 - 6.75 68 - 6.75 5.69 - 6.75 | | | | | 441023 | | | |
| 2 CV 4, 2 CV 6 Dyane 4, Dyane 6 AZU 250, 250 GA Mehari (2WD) | 3.70 - 6.79 7.75 - 6.79 7.75 - 7.75 - | 441024 | | | | 441023 | | | |
| 2 CV F.A.F., Mehari (4WD) AKS 400 Ami Super Berline & Break | 7.79 - 7.76 - 12.72 - | 441025 | | | | 441026 | | | |

AX

| | | | | | | | | | |
|---|------------|------------------|------------------|--|--|--------|--------|--------|--|
| 10 E/RE, 11 E/RE, 11 TRE (ZA) 1.3 Sport, 1.4 RE Sport 14 TRS, 14 TZS, 14 D/RD/TRD, GT 1.4 Allure 15 D Electric | 86 - 12.98 | 665502 | 365506 375036 | | | 441065 | 341101 | 241006 | |
| | | MB1901 SM1902 | | | | | | | |

Berlingo → Citroën Commercial

| | | | | | | | | | |
|--|--|--|--|--|--|--|--|--|--|
| | | | | | | | | | |
|--|--|--|--|--|--|--|--|--|--|

C1

| | | | | | | | | | |
|----------------|--------|----------------|----------------------|--|----------------|--|--------|--|--|
| 1.0 i 1.4 D | 6.05 - | | 332808 L 332807 R | | | | 343808 | | |
| | | 910123 SM1930 | | | 912023 SM9913 | | | | |

C1 II

| | | | | | | | | | |
|-----------------------------|--------|----------------|----------------------|--|----------------|--|--------|--|--|
| Incl. Panorama Sunroof, | 4.14 - | | 332808 L 332807 R | | | | 343808 | | |
| | | 910123 SM1930 | | | 912023 SM9913 | | | | |

C2

| | | | | | | | | | |
|---|--------|--|----------------------|--|--|--|--------|--|--|
| 1.1 i, 1.4 i, 1.6 i (J) 1.4 HDi, 1.6 HDi Exc. | 9.03 - | | 334826 L 334827 R | | | | 343396 | | |
| | | 910008 MB1901 ³⁾ SM1922 ¹⁾ SM1931 ²⁾³⁾ | | | | | | | |

1) 9.03 - 8.04

2) 8.04-

3) Incl. 1.6 VTS



| MODEL FAHRZEUG MODELE | YEAR JAHR ANNEE | FRONT/VORNE/AVANT | | | | REAR/HINTEN/ARRIERE | | | |
|--|-----------------------|-----------------------------|-----------------------------|--|--|-----------------------------|---|--------------------------------|--|
| | | PREMIUM Twin-tube Oil | EXCEL-G Twin-tube Gas | GAS-A-JUST Mono-tube Gas | | PREMIUM Twin-tube Oil | EXCEL-G Twin-tube Gas | GAS-A-JUST Mono-tube Gas | |
| Citroën (F) | | | | | | | | | |
| C3 I | | | | | | | | | |
| 1.1 i 1.4 i Exclusive 1.4 HDi Exc. 1.4 HDi-16V, , Entreprise | (F) | 4.02 - | | 334826 L 334827 R | | | 343396 | | |
| | | | 910008 | MB1901 SM1922 ¹⁾ SM1931 ²⁾ | | | | | |
| 1.4 i Exclusive 1.4 HDi- 16V 1.6 i-16V 1.6 HDi-16V Exc. , Entreprise | (F) | 4.02 - | | 334828 L 334829 R | | | 343396 | | |
| | | | 910008 | MB1901 SM1922 ¹⁾ SM1931 ²⁾ | | | | | |
| 1.1 i Entreprise 1.4 HDi Entreprise Exc. | (F) | 4.02 - | | 334826 L 334827 R | | | 343404 | | |
| | | | 910008 | MB1901 SM1922 ¹⁾ SM1931 ²⁾ | | | | | |
| | (F) | 4.02 - | | 334826 L 334827 R | | | 343404 | | |
| | | | 910008 | MB1901 SM1922 ¹⁾ SM1931 ²⁾ | | | | | |
| 1) 4.02 - 8.04 | | 2) 8.04 - | | | | | | | |
| C3 II | | | | | | | | | |
| 1.0 VTi 68, 1.1 i, 1.1 BiFuel (SC_) 1.2 THP 110, 1.2 VTi 82, 1.4, 1.4 LPG 1.6 BlueHDi 75, 1.6 BlueHDi 100 Incl. | (SC_) | 9.09 - | | 339805 L 339804 R | | | 348031 ¹⁾ 3448000 ²⁾ | | |
| | | | 910197 | MB1901 SM1553 | | | | | |
| 1.4 VTi 95 (70 kW), 1.4 VTi (72 kW) (SC_) Exc. | (SC_) | 11.09 - 9.12 | | 339803 L 339802 R | | | 348031 ¹⁾ 3448000 ²⁾ | | |
| | | | 910197 | MB1901 SM1553 | | | | | |
| 1.4 VTi 95 (70 kW), 1.4 VTi (72 kW) (SC_) Exc. | (SC_) | 10.12 - | | 339805 L 339804 R | | | 348031 ¹⁾ 3448000 ²⁾ | | |
| | | | 910197 | MB1901 SM1553 | | | | | |
| 1.4 VTi 95 (70 kW), 1.4 VTi (72 kW) (SC_) | (SC_) | 11.09 - | | 339805 L 339804 R | | | 348031 ¹⁾ 3448000 ²⁾ | | |
| | | | 910197 | MB1901 SM1553 | | | | | |
| 1) | | 2) | | | | | | | |



Citroën

| MODEL FAHRZEUG MODELE | YEAR JAHR ANNEE | FRONT/VORNE/AVANT | | | | REAR/HINTEN/ARRIERE | | | |
|-----------------------------|-----------------------|-----------------------------|-----------------------------|--------------------------------|--|-----------------------------|-----------------------------|--------------------------------|--|
| | | PREMIUM Twin-tube Oil | EXCEL-G Twin-tube Gas | GAS-A-JUST Mono-tube Gas | | PREMIUM Twin-tube Oil | EXCEL-G Twin-tube Gas | GAS-A-JUST Mono-tube Gas | |

Citroën (F)

C3 II

| | | | | | | | | |
|------------------------|--------------|--|--|--|--|---|--|--|
| 1.6 VTi 120 (SC_) | 11.09 - | | 339803 L ¹⁾ 339802 R ¹⁾ 339795 L ²⁾ 339794 R ²⁾ | | | 348031 ³⁾ 3448000 ⁴⁾ | | |
| 1.4 HDi 70 Exc. | 11.09 - 1.12 | | 339805 L 339804 R | | | 348031 | | |
| 1.4 HDi 70 Exc. | 11.09 - 1.12 | | 339803 L 339802 R | | | 348031 | | |
| 1.4 HDi 70 Exc. | 2.12 - | | 339805 L 339804 R | | | 348031 | | |
| 1.4 HDi 70 | 11.09 - | | 339805 L 339804 R | | | 348031 | | |
| 1.6 HDi 90 (66 kW) | 11.09 - | | 339803 L 339802 R | | | 348031 | | |
| 1.6 HDi (68 kW) | 11.09 - 9.12 | | 339803 L ¹⁾ 339802 R ¹⁾ 339795 L ²⁾ 339794 R ²⁾ | | | 348031 ³⁾ 3448000 ⁴⁾ | | |
| 1.6 HDi (68 kW) | 10.12 - 9.16 | | 339805 L ¹⁾ 339804 R ¹⁾ 339795 L ²⁾ 339794 R ²⁾ | | | 348031 ³⁾ 3448000 ⁴⁾ | | |

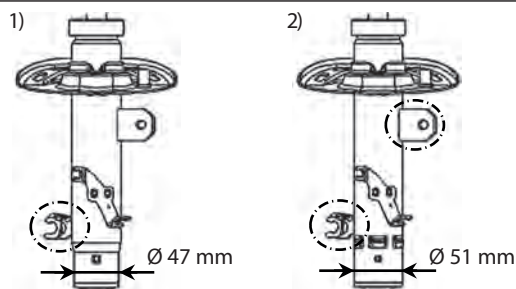



| MODEL FAHRZEUG MODELE | YEAR JAHR ANNEE | FRONT/VORNE/AVANT | | | | REAR/HINTEN/ARRIERE | | | |
|--|-----------------------|--|--|--------------------------------|--|---|-----------------------------|--------------------------------|--|
| | | PREMIUM Twin-tube Oil | EXCEL-G Twin-tube Gas | GAS-A-JUST Mono-tube Gas | | PREMIUM Twin-tube Oil | EXCEL-G Twin-tube Gas | GAS-A-JUST Mono-tube Gas | |
| Citroën (F) | | | | | | | | | |
| C3 II | | | | | | | | | |
| 1.6 HDi 110 (82 kW) 1.6 HDi 115 (84 kW) | (SC_) 11.09- | | 339795 L 339794 R | | | 348031 ¹⁾ 3448000 ²⁾ | | | |
| | | 910197 | MB1901 SM1553 | | | | | | |
| 1) L max. = 468 mm 2) L max. = 436 mm | | | | | | | | | |
| C3 III | | | | | | | | | |
| | (SX_, SY_) 7.16- | | 3338058 L ¹⁾ 3338057 R ¹⁾ 3348099 L ²⁾ 3348098 R ²⁾ | | | 3438000 | | | |
| | | 910260 ³⁾ 910261 ⁴⁾ | | | | | | | |
| 1) Ø 20 mm Ø 51 mm 2) Ø 20 mm Ø 47 mm 3) 86 mm Exc. H/D, 4) 76 mm Exc. H/D, | | | | | | | | | |
| C3 Picasso | | | | | | | | | |
| 1.4 VTi 95, 1.4 VTi 95 LPG 1.6 VTi 120 (88 kW) 1.6 HDi 90 (68 kW), 1.6 HDi 110 (82 kW) 1.6 HDi 115 (84 kW), 1.6 HDi (90 kW, 110 kW) | (SH_) 2.09- | | 333777 L 333776 R | | | 349019 | | | |
| | | | MB1901 SM1553 | | | | | | |
| 1.6 VTi (84 kW) | (SH_) 7.09- 2.14 | | 333777 L 333776 R | | | 349019 | | | |
| | | | MB1901 SM1553 | | | | | | |
| 1.6 VTi (84 kW) | (SH_) 3.14- | | | | | 349019 | | | |
| | | | MB1901 SM1553 | | | | | | |
| 1.2 THP 110 1.6 BlueHDi 100 | (SH_) 1.15- | | | | | 349019 | | | |
| | | | MB1901 SM1553 | | | | | | |



| MODEL FAHRZEUG MODELE | YEAR JAHR ANNEE | FRONT/VORNE/AVANT | | | | REAR/HINTEN/ARRIERE | | | |
|---|-----------------------|-----------------------------|--|--------------------------------|--|-----------------------------|-----------------------------|--------------------------------|--|
| | | PREMIUM Twin-tube Oil | EXCEL-G Twin-tube Gas | GAS-A-JUST Mono-tube Gas | | PREMIUM Twin-tube Oil | EXCEL-G Twin-tube Gas | GAS-A-JUST Mono-tube Gas | |
| Citroën (F) | | | | | | | | | |
| C3 Pluriel | | | | | | | | | |
| 1.4, 1.4 HDi, 1.4 Hybrid, 1.6 (HB) | 5.03 - | | 334826 L 334827 R | | | | 343404 | | |
| | | 910008 | MB1901 SM1922 ¹⁾ SM1931 ²⁾ | | | | | | |
| 1) 4.02 - 8.04 | 2) 8.04- | | | | | | | | |
| C3 Aircross II | | | | | | | | | |
| (2R_, 2C_) Exc. 1.2 PureTech 82 (60 kW) | 6.17 - | | 3338052 L 3338051 R | | | | 3438001 | | |
| 1.2 PureTech 82 (60 kW) | 6.17 - | | 3338050 L 3338049 R | | | | 3438001 | | |
| C4 | | | | | | | | | |
| 1.4 i, 1.6 i, 1.6 THP, 1.6 VTi, 1.6 HDi 1.6 16V Bio-Flex, 2.0 i, 2.0 HDi Exc. Sport sus., | 11.04 - 7.11 | | 333758 L 333757 R | | | | 344407 | | |
| | | 910067 | MB1901 SM1923 | | | 910095 | SM9902 | | |
| C4 II | | | | | | | | | |
| 1.2 THP 110, 1.2 THP 130, 1.4 VTi 95 (B7) 1.6 THP 155, 1.6 VTi 120, 1.6 VTi 120 LPG 1.6 BlueHDi 100, 1.6 BlueHDi 115 1.6 BlueHDi 120 1.6 HDi 90, 1.6 HDi 110, 1.6 HDi 115 2.0 HDi / BlueHDi 150 Exc. H/D, | 11.09 - | | 339807 L 339806 R | | | | 344408 | | |
| | | 910067 | MB1901 SM1933 | | | 910095 | SM9903▼ SM9901 | | |
| 2.0 HDi / BlueHDi 160 (B7) Exc. H/D, | 10.10 - | | 339807 L 339806 R | | | | 345085 | | |
| | | 910067 | MB1901 SM1933 | | | 910095 | SM9903▼ SM9901 | | |
| 1.2 THP 110, 1.2 THP 130, 1.6 VTi 120 (B7) 1.6 BlueHDi 100, 1.6 BlueHDi 115 1.6 BlueHDi 120, 1.6 HDi 110, 1.6 HDi 115 2.0 HDi / BlueHDi 150 (= DW10FD) H/D Exc. | 11.09 - | | 3348059 L 3348058 R | | | | 344408 | | |
| | | 910067 | MB1901 SM1933 | | | 910095 | SM9903▼ SM9901 | | |
| 1.2 THP 110, 1.2 THP 130 (B7) 1.6 BlueHDi 100 1.6 BlueHDi 115 (= DV6FC) 1.6 BlueHDi 120 H/D Exc. H/D | 4.14 - | | 339807 L 339806 R | | | | 344408 | | |
| | | 910067 | MB1901 SM1933 | | | 910095 | SM9903▼ SM9901 | | |
| 1.6 BlueHDi 115 (= DV6C) (B7) 1.6 HDi 90, 1.6 HDi 110, 1.6 HDi 115 H/D Exc. H/D | 11.09 - | | 339829 L 339828 R | | | | 344408 | | |
| | | 910067 | MB1901 SM1933 | | | 910095 | SM9903▼ SM9901 | | |



| MODEL FAHRZEUG MODELE | YEAR JAHR ANNEE | FRONT/VORNE/AVANT | | | | REAR/HINTEN/ARRIERE | | | |
|-----------------------------|-----------------------|-----------------------------|-----------------------------|--------------------------------|--|-----------------------------|-----------------------------|--------------------------------|--|
| | | PREMIUM Twin-tube Oil | EXCEL-G Twin-tube Gas | GAS-A-JUST Mono-tube Gas | | PREMIUM Twin-tube Oil | EXCEL-G Twin-tube Gas | GAS-A-JUST Mono-tube Gas | |

Citroën (F)

C4 Aircross

| | | | | | | | |
|------|--------|----------------------------|----------------------|--|--------|--------|--|
| | 4.12 - | | 339254 L 339253 R | | | 340060 | |
| | | 935304 ▼ SM5657 912053 | | | 910349 | | |

C4 Cactus

| | | | | | | | |
|---|-------------|----------------|--|--|--|-----------------------|--|
| 1.2 PureTech 130, 1.2 THP 110 1.2 VTi 75 / PureTech 75, 1.2 VTi 82 1.6 BlueHDi 100, 1.6 HDi 90 | 9.14 - 1.18 | | 339803 L ¹⁾ 339802 R ¹⁾ | | | 3438010 | |
| | | 910197 SM1553 | | | | | |
| 1.2 PureTech 82, 1.2 PureTech 110 1.2 PureTech 130, 1.2 THP 110 1.2 VTi 75 / PureTech 75, 1.2 VTi 82 1.5 BlueHDi 100, 1.5 BlueHDi 120 1.6 BlueHDi 100, 1.6 HDi 90 | 2.18 - | | 3338058 L ²⁾ 3338057 R ²⁾ 3348099 L ³⁾ 3348098 R ³⁾ | | | 3438001 ⁴⁾ | |
| | | 910197 SM1553 | | | | | |

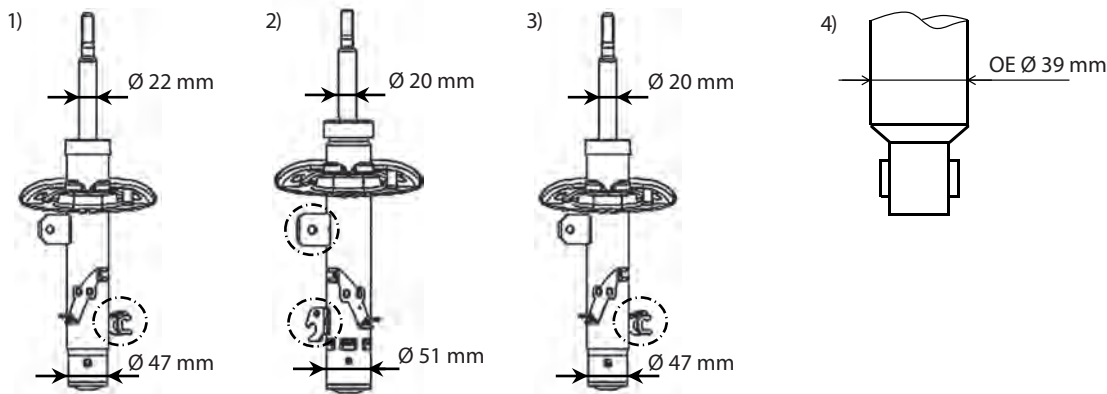

C4 Picasso I, C4 Grand Picasso I

| | | | | | | | |
|--|--------|--|----------------------|--|--|---------|--|
| | 9.06 - | | 333773 L 333772 R | | | 3450005 | |
| | | 910067 MB1901 SM1923 ¹⁾ SM1061 ¹⁾ | | | | | |

1)

| | C4 Picasso I / C4 Grand Picasso I | | →RPO 13110 →30.09.2012 | RPO 13111→ 01.10.2012→ |
|-----------|--------------------------------------|----------------|---------------------------|---------------------------|
| DV6C | 1.6 HDi, 1.6 e-HDi | 82 kW | SM1923 | SM1061 |
| DV6TED4 | 1.6 HDi, 1.6 e-HDi | 80 kW | SM1923 | SM1923 |
| DW10BTED4 | 2.0 HDi | 100 kW | SM1923 | SM1923 |
| DW10CTED4 | 2.0 HDi | 110kW, 120 kW | SM1923 | SM1061 |
| EP6 | 1.6 VTi | 88 kW | SM1923 | SM1923 |
| EP6C | 1.6 VTi | 88 kW | SM1923 | ∅ |
| EP6CDT | 1.6 THP | 115 kW | SM1923 | ∅ |
| EP6DT | 1.6 THP | 103 kW, 110 kW | SM1923 | SM1923 |
| EW10A | 2.0 | 103 kW | SM1923 | SM1061 |
| EW7A | 1.8 i, 1.8 Flex, 1.8 BiFuel, 1.8 CNG | 86 kW, 92 kW | SM1923 | SM1923 |



Citroën

| MODEL FAHRZEUG MODELE | YEAR JAHR ANNEE | FRONT/VORNE/AVANT | | | | REAR/HINTEN/ARRIERE | | | |
|--|-----------------------|-----------------------------|--------------------------------|--------------------------------|--|-----------------------------|-----------------------------|--------------------------------|--|
| | | PREMIUM Twin-tube Oil | EXCEL-G Twin-tube Gas | GAS-A-JUST Mono-tube Gas | | PREMIUM Twin-tube Oil | EXCEL-G Twin-tube Gas | GAS-A-JUST Mono-tube Gas | |
| Citroën (F) | | | | | | | | | |
| C4 Picasso II, C4 Grand Picasso II | | | | | | | | | |
| C4 Picasso II Exc. H/D, , | 2.13 - 10.15 | | 3348002 | | | | 3448001 | | |
| | | 910279 ¹⁾ | SM1055 ²⁾ | | | | | | |
| C4 Picasso II Exc. H/D, , | 11.15 - 6.17 | | 3348002 | | | | | | |
| | | 910279 ¹⁾ | SM1055 ²⁾ | | | | | | |
| C4 Grand Picasso II Exc. H/D, , | 9.13 - 6.17 | | 3348002 | | | | | | |
| | | 910279 ¹⁾ | SM1055 ²⁾ | | | | | | |
| 1) 2.13 → 2) 2.13 → Incl. H/D, | | | | | | | | | |
| C4 Spacetourer | | | | | | | | | |
| (3D_) | 4.18 - | | | | | | | | |
| | | | | SM1055 | | | | | |
| C5 III Exc. Hydractive | | | | | | | | | |
| (RD) Exc. | 2.08 - | | 341850 | | | | 341851 | | |
| | | 910161 | SM1929 | | | 917004 | | | |
| C5 III Exc. Hydractive | | | | | | | | | |
| (TD) Exc. | 2.08 - | | 341850 | | | | 341852 | | |
| | | 910161 | SM1929 | | | 917004 | | | |
| C5 Aircross | | | | | | | | | |
| 1.2 PureTech 130, 1.6 PureTech 180 1.6 THP 150, 1.6 THP 165 1.5 BlueHDi 130, 2.0 BlueHDi 180 Exc. Active sus. | 11.18 - | | 3348095 | | | | 3448001 | | |
| | | | | | | | | | |
| 1.2 PureTech 130, 1.6 PureTech 180 1.6 THP 150, 1.6 THP 165 1.5 BlueHDi 130, 2.0 BlueHDi 180 Active sus. | 11.18 - | | 3348095 | | | | 3448033 | | |
| | | | | | | | | | |
| C8 | | | | | | | | | |
| 2.0, 2.0 16V, 2.0 HDi, 2.2, 2.2 HDi, 3.0 V6 | 7.02 - | | 335934 L 335933 R | | | 443303 | 343321 | | |
| | | 910124 | MB1907 SM1916 L SM1917 R | | | | | | |
| C-Crosser | | | | | | | | | |
| 2.2 HDi, 2.4 16V (EP) | 2.07 - | | 339081 L 339080 R | | | | 349040 | | |
| | | 935304 ▼ 912053 | SM5657 | | | 910349 | SM5091 | | |



| MODEL FAHRZEUG MODELE | YEAR JAHR ANNEE | FRONT/VORNE/AVANT | | | | REAR/HINTEN/ARRIERE | | | |
|---|----------------------------|-----------------------------|--|--------------------------------|--|-----------------------------|-----------------------------|--------------------------------|--|
| | | PREMIUM Twin-tube Oil | EXCEL-G Twin-tube Gas | GAS-A-JUST Mono-tube Gas | | PREMIUM Twin-tube Oil | EXCEL-G Twin-tube Gas | GAS-A-JUST Mono-tube Gas | |
| Citroën (F) | | | | | | | | | |
| C-Elysée | | | | | | | | | |
| (DD_) 11.12- 10.17 | | | 3338001 L ¹⁾ 3338000 R ¹⁾ | | | | 3438000 | | |
| | | 910261 ²⁾ | MB1901 SM1553 | | | | | | |
| (DD_) 11.17- | | | | | | | 3438000 | | |
| | | | MB1901 SM1553 | | | | | | |
| 1) Ø 47 mm 2) → 1.13 | | | | | | | | | |
| DS3 | | | | | | | | | |
| 1.4 VTi (70 kW), 1.4 HDi 1.4 VTi (72 kW) Exc. | 4.10- 12.12 11.09- 7.15 | | 339801 L ¹⁾ 339800 R ¹⁾ | | | | 3448000 | | |
| | | 910259 | MB1901 SM1553 | | | | | | |
| 1.4 VTi (70 kW), 1.4 HDi 1.4 VTi (72 kW) | 4.10- 12.12 11.09- 7.15 | | 339805 L ¹⁾ 339804 R ¹⁾ | | | | 3448000 | | |
| | | 910259 | MB1901 SM1553 | | | | | | |
| 1.4 VTi (70 kW), 1.4 HDi | 1.13- 7.15 | | 339801 L ¹⁾ 339800 R ¹⁾ 339795 L ²⁾ 339794 R ²⁾ | | | | 3448000 | | |
| | | 910259 | MB1901 SM1553 | | | | | | |
| 1.4 VTi 95 LPG | 8.12- 12.12 | | 339801 L ¹⁾ 339800 R ¹⁾ | | | | 3448000 | | |
| | | 910259 | MB1901 SM1553 | | | | | | |
| 1.6, 1.6 THP (110 kW, 115 kW) 1.6 HDi (82 kW, 84 kW) Exc. 1.6 Racing | 11.09- 12.12 | | 339795 L ²⁾ 339794 R ²⁾ | | | | 3448000 | | |
| | | 910259 | MB1901 SM1553 | | | | | | |
| 1.2 THP, 1.2 VTi, 1.4 VTi 95 LPG 1.6, 1.6 THP 1.6 BlueHDi, 1.6 HDi (kW : 82, 84, 85) Exc. 1.6 Racing | 1.13- 7.15 | | 339801 L ¹⁾ 339800 R ¹⁾ 339795 L ²⁾ 339794 R ²⁾ | | | | 3448000 | | |
| | | 910259 | MB1901 SM1553 | | | | | | |
| 1) Ø 47 mm 2) Ø 51 mm | | | | | | | | | |



Citroën

| MODEL FAHRZEUG MODELE | YEAR JAHR ANNEE | FRONT/VORNE/AVANT | | | | REAR/HINTEN/ARRIERE | | | |
|-----------------------------|-----------------------|-----------------------------|-----------------------------|--------------------------------|--|-----------------------------|-----------------------------|--------------------------------|--|
| | | PREMIUM Twin-tube Oil | EXCEL-G Twin-tube Gas | GAS-A-JUST Mono-tube Gas | | PREMIUM Twin-tube Oil | EXCEL-G Twin-tube Gas | GAS-A-JUST Mono-tube Gas | |

Citroën (F)

DS3

| | | | | | | | | |
|---|-------------------------------|--------|--|--|--|---------|--|--|
| 1.6 VTi, 1.6 HDi (68 kW) Exc. 1.6 Racing | 11.09 - 12.12 | | 339801 L ¹⁾ 339800 R ¹⁾ | | | 3448000 | | |
| | | 910259 | MB1901 SM1553 | | | | | |
| 1.6 VTi Exc. 1.6 Racing | 4.10 - 4.11 | | 339795 L ²⁾ 339794 R ²⁾ | | | 348031 | | |
| | | 910259 | MB1901 SM1553 | | | | | |
| 1.6 VTi 1.6 HDi (68 kW) Exc. 1.6 Racing | 5.11 - 12.12 11.09 - 12.12 | | 339795 L ²⁾ 339794 R ²⁾ | | | 3448000 | | |
| | | 910259 | MB1901 SM1553 | | | | | |
| 1.6 VTi, 1.6 HDi (68 kW) Exc. 1.6 Racing | 1.13 - 7.15 | | 339801 L ¹⁾ 339800 R ¹⁾ 339795 L ²⁾ 339794 R ²⁾ | | | 3448000 | | |
| | | 910259 | MB1901 SM1553 | | | | | |
| 1.6 Racing | 2.11 - 7.15 | | | | | | | |
| | | 910259 | MB1901 SM1553 | | | | | |

DS3

| | | | | | | | | |
|---------------------|-------------|--------|--|--|--|---------|--|--|
| Exc. 1.6 Racing | 1.13 - 7.15 | | 339801 L ¹⁾ 339800 R ¹⁾ 339795 L ²⁾ 339794 R ²⁾ 339708 L ³⁾ 339707 R ³⁾ | | | 3448000 | | |
| | | 910259 | MB1901 SM1553 | | | | | |
| 1.6 Racing | 3.14 - 7.15 | | | | | | | |
| | | 910259 | MB1901 SM1553 | | | | | |

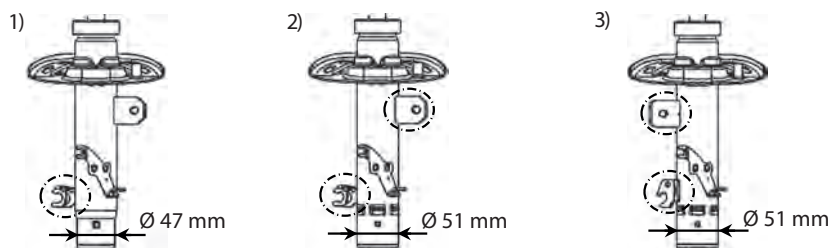



| MODEL FAHRZEUG MODELE | YEAR JAHR ANNEE | FRONT/VORNE/AVANT | | | | REAR/HINTEN/ARRIERE | | | |
|-----------------------------|-----------------------|-----------------------------|-----------------------------|--------------------------------|--|-----------------------------|-----------------------------|--------------------------------|--|
| | | PREMIUM Twin-tube Oil | EXCEL-G Twin-tube Gas | GAS-A-JUST Mono-tube Gas | | PREMIUM Twin-tube Oil | EXCEL-G Twin-tube Gas | GAS-A-JUST Mono-tube Gas | |

Citroën (F)

DS4

| | | | | | | | | | |
|--|-------------|--|----------------------|--|--|----------------|--------|--|--|
| 1.2 THP 130, 1.6 THP 165 1.6 BlueHDi 115, 1.6 BlueHDi 120 | 1.12 - 7.15 | | | | | | 345085 | | |
| | | 910067 ¹⁾ MB1901 910314 ¹⁾ SM1933 | | | | 910095 SM9901 | | | |
| 1.6 THP 150, 1.6 THP 160, 1.6 VTi 120 1.6 HDi 90, 1.6 HDi 110, 1.6 HDi 115 Incl. | 4.11 - 2.14 | | 339829 L 339828 R | | | | 345085 | | |
| | | 910067 ¹⁾ MB1901 910314 ¹⁾ SM1933 | | | | 910095 SM9901 | | | |
| 1.6 THP 150, 1.6 THP 160, 1.6 VTi 120 1.6 HDi 90, 1.6 HDi 110, 1.6 HDi 115 Incl. | 3.14 - 7.15 | | | | | | 345085 | | |
| | | 910067 ¹⁾ MB1901 910314 ¹⁾ SM1933 | | | | 910095 SM9901 | | | |
| 1.6 THP 155, 1.6 THP 200 2.0 HDi / BlueHDi 135, 2.0 BlueHDi 150 2.0 BlueHDi 165, 2.0 BlueHDi 180 | 4.11 - 7.15 | | 339829 L 339828 R | | | | 345085 | | |
| | | 910067 ¹⁾ MB1901 910314 ¹⁾ SM1933 | | | | 910095 SM9901 | | | |

1)

| Engine Type | Engine Code | |
|-------------|--|--------|
| Diesel | DV6C, DV6F, DV6DTED, DW10C_, DW10F_ | 910314 |
| | DV6DTED M, DW10C | 910067 |
| Petrol | EB2DT, EP6C (exc. 88 kW), EP6CDT, EP6CDT_, EP6FDT, EP6FDT_ | 910314 |
| | EP3C, EP6C (88 kW), EW10A, TU5JP4 | 910067 |

DS5

| | | | | | | | | | |
|---|--------------|---|------------------------|--|--|--|--------|--|--|
| Exc. Hybrid | 11.11 - 7.15 | | 3348038 L 3348037 R | | | | 349156 | | |
| | | 910198 ¹⁾ MB1901 SM1062 ²⁾ SM1063 ³⁾ | | | | | | | |
| 1.6 THP 165 Hybrid 2.0 HDi 165 Hybrid, 2.0 HDi 200 Hybrid Incl. | 12.11 - 7.15 | | 3348038 L 3348037 R | | | | | | |
| | | 910198 ¹⁾ MB1901 SM1062 ²⁾ SM1063 ³⁾ | | | | | | | |

1) OE = 5033C8 2) → 13103 3) 13104 →
Bumper height : 87 mm

Evasion / Synergie

| | | | | | | | | | |
|--|-------------|--|--------|--|--|----------------------|------------------------|--|--|
| | 94 - 1.98 | 634927 | 334927 | | | 443277 ¹⁾ | 343296 ¹⁾ ▼ | | |
| | | 910124 MB1907 SM1916 L SM1917 R | | | | | | | |
| | 1.98 - 8.00 | 634927 | 334927 | | | 443303 ²⁾ | 343321 ²⁾ | | |
| | | 910124 MB1907 SM1916 L SM1917 R | | | | | | | |

1) L max. = 370mm 2) L max. = 400 mm



| MODEL FAHRZEUG MODELE | YEAR JAHR ANNEE | FRONT/VORNE/AVANT | | | | REAR/HINTEN/ARRIERE | | | |
|--|-----------------------|-----------------------------|--------------------------------|--------------------------------|--|-----------------------------|-----------------------------|--------------------------------|--|
| | | PREMIUM Twin-tube Oil | EXCEL-G Twin-tube Gas | GAS-A-JUST Mono-tube Gas | | PREMIUM Twin-tube Oil | EXCEL-G Twin-tube Gas | GAS-A-JUST Mono-tube Gas | |
| Citroën (F) | | | | | | | | | |
| Evasion / Synergie | | | | | | | | | |
| ALL | 9.00 - 5.02 | 634927 | 334927 | | | 443303 ¹⁾ | 343321 ¹⁾ | | |
| | | 910124 | MB1907 SM1916 L SM1917 R | | | | | | |
| 1) L max. = 400 mm | | | | | | | | | |
| LN, LNA | | | | | | | | | |
| LN 602 cc | - 4.77 | 664004 | | | | | | | |
| LN 602 cc, 652 cc | 5.77 - 80 | 664004 | | | | 441041 | | | |
| LNA 652 cc, 1124 cc | 11.78 - 86 | | | | | 441041 | | | |
| | | 913112 | | | | | | | |
| Saxo | | | | | | | | | |
| 1.0, 1.1, 1.4, 1.5 D Exc. 1.6 16V | (S) 2.96 - 4.04 | 665502 | 365506 375036 | | | 441065 | 341101 | 241006 | |
| | | | MB1901 SM1903 | | | | | | |
| 1.6 16V | (S) 2.96 - 4.04 | | 365506 375036 | | | | 341101 | 241006 | |
| | | | MB1901 SM1903 | | | | | | |
| Electric | (S) 11.96 - 6.03 | | | | | | | | |
| | | | MB1901 SM1903 | | | | | | |
| Visa | | | | | | | | | |
| Visa & Visa II 0.6 Club 11E, 11RE 1.4, 1.4 RS, 1.4 TRS Exc. GT, Challenger, Chrono | 9.78 - 91 | | | | | 441027 | | | |
| | | 913112 | | | | | | | |
| Visa 1.4, 1.4 GT | 3.82 - 3.91 | | | | | | | | |
| | | 913112 | MB1901 SM1900 | | | | | | |
| Visa 1.0 Visa II Super X | 7.80 - 6.88 | | | | | | | | |
| | | 913112 | | | | | | | |
| Visa 17 D, 17 RD, 1.8 Diesel | 4.84 - 91 | 633828 | 333828 | | | | | | |
| | | 913112 | MB1901 SM1900 | | | | | | |



| MODEL FAHRZEUG MODELE | YEAR JAHR ANNEE | FRONT/VORNE/AVANT | | | | REAR/HINTEN/ARRIERE | | | |
|--|--|-----------------------------|--|--------------------------------|--|-----------------------------|-----------------------------|--------------------------------|--|
| | | PREMIUM Twin-tube Oil | EXCEL-G Twin-tube Gas | GAS-A-JUST Mono-tube Gas | | PREMIUM Twin-tube Oil | EXCEL-G Twin-tube Gas | GAS-A-JUST Mono-tube Gas | |
| Citroën (F) | | | | | | | | | |
| Visa | | | | | | | | | |
| Visa 1.6 GTI | 84- 91 | 634011 L 634010 R | 334023 L 334022 R | | | | | | |
| | | 913112 | MB1901 SM1900 | | | | | | |
| Xsara (N1/N0) | | | | | | | | | |
| 1.4, 1.6, 2.0 16V 1.5 D, 1.8 D, 1.9 D, 1.9 TD 2.0 HDi Exc. | 97- 9.00 | 633839 L 633838 R | 333839 L 333838 R 323839 L 323838 R | | | 441092 H/D 441093 | 341166 | 241008 | |
| | | 913112 | MB1901 SM1905 ¹⁾ SM1906 ²⁾ | | | | | | |
| 1.8 1.8 16V Exc. | 97- 9.00 | 633839 L 633838 R | 333839 L 333838 R 323839 L 323838 R | | | 441093 | 341166 | 241008 | |
| | | 913112 | MB1901 SM1905 ¹⁾ SM1906 ²⁾ | | | | | | |
| 1.4 i Exc. | 9.00- 3.05 | | 333733 L 333732 R MB1901 | | | 441092 H/D 441093 | 341166 | | |
| 1.4 HDi 1.6 16V 1.9 D 1.8 VTS Coupe 2.0 i 2.0 HDi Exc. , 2.0 VTS 16V | 1.03- 3.05 9.00- 3.05 9.00- 3.05 9.00- 3.05 9.00- 3.05 9.00- 3.05 | | 333735 L 333734 R 323735 L 323734 R MB1901 | | | 441093 | 341166 | 241008 | |
| 1) | | 2) | | | | | | | |
| Xsara (N2) | | | | | | | | | |
| 1.4, 1.6, 1.8, 2.0 1.5 D, 1.8 D, 1.9 D, 1.9 TD 2.0 HDi Exc. | 97- 9.00 | 633839 L 633838 R | 333839 L 333838 R 323839 L 323838 R | | | 441093 | 341166 | 241008 | |
| | | 913112 | MB1901 SM1905 ¹⁾ SM1906 ²⁾ | | | | | | |
| 1.4 i Exc. | 9.00- 8.05 | | 333733 L 333732 R MB1901 | | | 441092 H/D 441093 | 341166 | | |
| 1) | | 2) | | | | | | | |



Citroën

| MODEL FAHRZEUG MODELE | YEAR JAHR ANNEE | FRONT/VORNE/AVANT | | | | REAR/HINTEN/ARRIERE | | | |
|---|---|-----------------------------|------------------------------------|--|--|-----------------------------|-----------------------------|--------------------------------|--|
| | | PREMIUM Twin-tube Oil | EXCEL-G Twin-tube Gas | GAS-A-JUST Mono-tube Gas | | PREMIUM Twin-tube Oil | EXCEL-G Twin-tube Gas | GAS-A-JUST Mono-tube Gas | |
| Citroën (F) | | | | | | | | | |
| Xsara (N2) | | | | | | | | | |
| 1.4 HDI 1.6 i 1.9 D 2.0 i 2.0 HDi Exc. | 1.03 - 8.05 9.00 - 8.05 9.00 - 8.05 9.00 - 8.05 9.00 - 8.05 | | 333735 L 333734 R | | | 441093 | 341166 | | |
| | | | <u>323735 L</u> <u>323734 R</u> | | | | | 241008 | |
| | | | | MB1901 | | | | | |
| Xsara Picasso | | | | | | | | | |
| 1.6, 1.8 16V, 2.0 16V 1.6 HDI, 2.0 HDI | (N68) 10.99 - 2.07 | | 333737 L 333736 R | | | 441066 | 341102 | 551053▼ | |
| | | | 913112 | MB1901 SM1906 | | | | | |
| ZX | | | | | | | | | |
| 1.1, 1.4 1.7 Diesel 1.9 Diesel → 5683 Exc. Turbo Diesel | (N2) 91 - 7.97 92 - 7.97 91 - 5.92 | 633837 L 633836 R | 333837 L▼ 333836 R▼ | | | 441092 | 341166 | | |
| | | | 913112 | MB1901 SM1905 ¹⁾ SM1906 ²⁾ | | H/D 441093 | | | |
| 1.6, 1.8 | (N2) 91 - 7.97 | 633839 L 633838 R | 333839 L 333838 R | | | 441092 | 341166 | | |
| | | | <u>323839 L</u> <u>323838 R</u> | | | H/D 441093 | | 241008 | |
| | | | 913112 | MB1901 SM1905 ¹⁾ SM1906 ²⁾ | | | | | |
| 1.9 Diesel ⊖ ABS 5684 → Exc. Turbo Diesel | (N2) 6.92 - 7.97 | 633837 L 633836 R | 333837 L▼ 333836 R▼ | | | 441092 | 341166 | | |
| | | | 913112 | MB1901 SM1905 ¹⁾ SM1906 ²⁾ | | H/D 441093 | | | |
| 1.9 Diesel ⊕ ABS 5684 → Exc. Turbo Diesel | (N2) 6.92 - 7.97 | 633839 L 633838 R | 333839 L 333838 R | | | 441092 | 341166 | | |
| | | | <u>323839 L</u> <u>323838 R</u> | | | H/D 441093 | | 241008 | |
| | | | 913112 | MB1901 SM1905 ¹⁾ SM1906 ²⁾ | | | | | |
| 1.9 Turbo Diesel Exc. Volcane | (N2) 91 - 7.97 | 633839 L 633838 R | 333839 L 333838 R | | | 441092 | 341166 | | |
| | | | <u>323839 L</u> <u>323838 R</u> | | | H/D 441093 | | 241008 | |
| | | | 913112 | MB1901 SM1905 ¹⁾ SM1906 ²⁾ | | | | | |
| 1) | | | | | | | | | |
| 2) | | | | | | | | | |



| MODEL FAHRZEUG MODELE | YEAR JAHR ANNEE | FRONT/VORNE/AVANT | | | | REAR/HINTEN/ARRIERE | | | |
|---|-----------------------|---|-----------------------------|---|--|-----------------------------|-----------------------------|--------------------------------|--|
| | | PREMIUM Twin-tube Oil | EXCEL-G Twin-tube Gas | GAS-A-JUST Mono-tube Gas | | PREMIUM Twin-tube Oil | EXCEL-G Twin-tube Gas | GAS-A-JUST Mono-tube Gas | |
| Citroën (F) | | | | | | | | | |
| ZX | | | | | | | | | |
| 1.9i → 5683 2.0i → 5683 Exc. 16V | (N2) | 91 - 5.92 91 - 5.92 | | | | | | | |
| | | | | | | 441093 | 341166 | | |
| | | | | MB1901 SM1905 ¹⁾ SM1906 ²⁾ | | | | | |
| 1.9 Turbo Diesel Volcane 1.9i 5684 → 2.0i 5684 → Exc. 16V | (N2) | 91 - 7.97 5.92 - 7.97 5.92 - 7.97 | 633839 L 633838 R | 333839 L 333838 R 323839 L 323838 R | | | | | |
| | | | | | | 441093 | 341166 | 241008 | |
| | | | | 913112 MB1901 SM1905 ¹⁾ SM1906 ²⁾ | | | | | |
| 2.0 i 16V | (N2) | 92 - 7.97 | | 333839 L 333838 R 323839 L 323838 R | | | | | |
| | | | | | | | 341166 | 241008 | |
| | | | | 913112 MB1901 SM1905 ¹⁾ SM1906 ²⁾ | | | | | |
| 1) | | 2) | | | | | | | |
| ZX | | | | | | | | | |
| 1.4i, 1.6i, 1.8i 1.9 Diesel, 1.9 Turbo Diesel | (N2) | 94 - 7.97 | 633839 L 633838 R | 333839 L 333838 R 323839 L 323838 R | | | | | |
| | | | | | | 441093 | 341166 | 241008 | |
| | | | | 913112 MB1901 SM1905 ¹⁾ SM1906 ²⁾ | | | | | |
| 1) | | 2) | | | | | | | |
| Citroën Commercial (F) | | | | | | | | | |
| Berlingo | | | | | | | | | |
| ALL | (M) | 96 - 12.02 | 633839 L 633838 R | 333839 L 333838 R | | | | | |
| | | | | | | 441105 | 341237 | | |
| | | | | 913112 MB1901 SM1905 ¹⁾ SM1906 ²⁾ | | | | | |
| ALL | (M) | 96 - 12.02 | | 333839 L 333838 R | | | | | |
| | | | | | | 441105 | 341237 | | |
| | | | | 913112 MB1901 SM1905 ¹⁾ SM1906 ²⁾ | | | | | |
| 1) | | 2) | | | | | | | |



Citroën

| MODEL FAHRZEUG MODELE | YEAR JAHR ANNEE | FRONT/VORNE/AVANT | | | REAR/HINTEN/ARRIERE | | |
|-----------------------------|-----------------------|-----------------------------|-----------------------------|--------------------------------|-----------------------------|-----------------------------|--------------------------------|
| | | PREMIUM Twin-tube Oil | EXCEL-G Twin-tube Gas | GAS-A-JUST Mono-tube Gas | PREMIUM Twin-tube Oil | EXCEL-G Twin-tube Gas | GAS-A-JUST Mono-tube Gas |

Citroën Commercial (F)

Berlingo

| | | | | | | | |
|------------------------------------|-----------------------|--|--|--|--------|----------------------|--|
| (G/M/MF) | 12.02 - 5.08 | | 333730 L 333729 R | | 441105 | 341237 | |
| 913112 | | | MB1901 SM1905 ¹⁾ SM1906 ²⁾ | | | | |
| (B9) Exc. H/D, 3rd seat row | 6.08 - | | 910067 | | | 349155 ⁴⁾ | |
| 910067 | | | MB1901 SM1061 ³⁾ | | | | |
| (B9) ⊕ 3rd seat row Exc. H/D | 4.08 - | | 338734 L 338733 R | | | 349155 ⁴⁾ | |
| 910067 | | | MB1901 SM1061 ³⁾ | | | | |
| (B9) ⊕ H/D | 4.08 - | | 338736 L 338735 R | | | 349156 | |
| 910067 | | | MB1901 SM1061 ³⁾ | | | | |
| (B9) LONG | 4.08 - | | 338734 L 338733 R | | | 349155 ⁴⁾ | |
| 910067 | | | MB1901 SM1061 ³⁾ | | | | |
| (B9) Exc. LONG | 2.08 - 6.08 2.08 - | | 910067 | | | 349157 | |
| 910067 | | | MB1901 SM1061 ³⁾ | | | | |
| (B9) Exc. LONG | 6.08 - | | 910067 | | | 349155 ⁴⁾ | |
| 910067 | | | MB1901 SM1061 ³⁾ | | | | |

- 1)
- 2)

3)

| | Application | kW | | →13145 →10.2012 | 13146→ 11.2012→ |
|---------------------|--------------|--------|--------|--------------------|--------------------|
| DV6ATED4 | 1.6 HDi | 66 | SM1061 | ∅ | ∅ |
| DV6ATED4/DV6TED4B | 1.6 HDi | 66 | ∅ | ∅ | SM1061 |
| DV6AUTED4/DV6TED4BU | 1.6 HDi | 66 | ∅ | ∅ | SM1061 |
| DV6BTED4 | 1.6 HDi | 55 | ∅ | ∅ | SM1061 |
| DV6BTED4/DV6BUTED4 | 1.6 HDi | 55 | ∅ | ∅ | SM1061 |
| DV6C | 1.6 HDi | 82, 84 | ∅ | ∅ | SM1061 |
| DV6C/DV6CTED | 1.6 HDi | 84 | ∅ | ∅ | SM1061 |
| DV6DTED | 1.6 HDi | 66, 68 | ∅ | ∅ | SM1061 |
| DV6DTED/DV6DTEDM | 1.6 HDi | 68 | ∅ | ∅ | SM1061 |
| DV6ETED/DV6FE | 1.6 HDi | 55 | ∅ | ∅ | SM1061 |
| DV6FC | 1.6 HDi | 88 | SM1061 | ∅ | ∅ |
| DV6FD | 1.6 HDi | 73 | SM1061 | ∅ | ∅ |
| DV6TED4 | 1.6 HDi | 80 | ∅ | ∅ | SM1061 |
| EB2DT | 1.2 | 81 | SM1061 | ∅ | ∅ |
| EP6C | 1.6, 1.6 VTi | 88 | ∅ | ∅ | SM1061 |
| EP6CB | 1.6 VTi | 72 | ∅ | ∅ | SM1061 |
| EP6CB | 1.6 | 115 | ∅ | ∅ | ∅ |
| TU5JP4 | 1.6 | 80 | ∅ | ∅ | SM1061 |
| TU5JP4B | 1.6 | 66 | ∅ | ∅ | SM1061 |
| Y4F1 | Electric | 49, 35 | ∅ | ∅ | ∅ |

4) 6.08 →

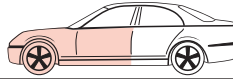

| MODEL FAHRZEUG MODELE | YEAR JAHR ANNEE | FRONT/VORNE/AVANT | | | | REAR/HINTEN/ARRIERE | | | |
|-----------------------------|-----------------------|-----------------------------|-----------------------------|--------------------------------|--|-----------------------------|-----------------------------|--------------------------------|--|
| | | PREMIUM Twin-tube Oil | EXCEL-G Twin-tube Gas | GAS-A-JUST Mono-tube Gas | | PREMIUM Twin-tube Oil | EXCEL-G Twin-tube Gas | GAS-A-JUST Mono-tube Gas | |

Citroën Commercial (F)

Berlingo

| | | | | | | | | | | |
|---------------------------------|----------|--------|--|--|--|--|--|---------|--|--|
| 2WD Exc. e-Berlingo | (ER, EC) | 6.18 - | | | | | | | | |
| | | | | | | | | | | |
| 2WD / Exc. e-Berlingo | (K9) | 6.18 - | | | | | | 3418008 | | |
| | | | | | | | | | | |

C 15

| | | | | | | | | | | |
|---------------------|------|--------------|--------|--------|--|--|--|--------|--|--|
| C15 e | (VD) | 10.84 - 5.88 | | | | | | 441962 | | |
| | | | | | | | | | | |
| C15 Diesel C15 e | (VD) | 5.88 - 12.00 | 633828 | 333828 | | | | 441962 | | |
| | | | | | | | | | | |

1) Exc. 1.1 (40 kW)

C 25

| | | | | | | | | | | |
|----------|--|------------|--------|--|--|--|--|--------|--|--|
| Exc. | | 81 - 12.85 | 635850 | | | | | 445022 | | |
| | | | | | | | | | | |
| | | 81 - 12.85 | 635850 | | | | | 445092 | | |
| | | | | | | | | | | |
| Exc. | | 1.86 - 94 | 635851 | | | | | 445022 | | |
| | | | | | | | | | | |
| Exc. | | 1.86 - 94 | 635851 | | | | | 445092 | | |
| | | | | | | | | | | |

Jumper / Relay

| | | | | | | | | | | |
|------------------------------------|-------|------------|--------|--|--|--|--|--------|--|--|
| Incl. Exc. H/D, Camping Car | (230) | 94 - 12.01 | 635806 | | | | | 344283 | | |
| | | | | | | | | | | |
| | | | | | | | | | | |
| Incl. Exc. H/D, Camping Car | (230) | 94 - 12.01 | 635806 | | | | | 344284 | | |
| | | | | | | | | | | |
| | | | | | | | | | | |

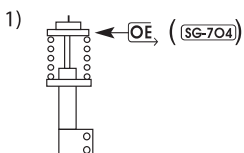

2)

| | |
|----------|----------|
| 15616153 | 15616153 |
| | |
| | |



| MODEL FAHRZEUG MODELE | YEAR JAHR ANNEE | FRONT/VORNE/AVANT | | | | REAR/HINTEN/ARRIERE | | | |
|-----------------------------|-----------------------|-----------------------------|-----------------------------|--------------------------------|--|-----------------------------|-----------------------------|--------------------------------|--|
| | | PREMIUM Twin-tube Oil | EXCEL-G Twin-tube Gas | GAS-A-JUST Mono-tube Gas | | PREMIUM Twin-tube Oil | EXCEL-G Twin-tube Gas | GAS-A-JUST Mono-tube Gas | |

Citroën Commercial (F)

Jumper / Relay 2WD 4WD

| | | | | | | | | | |
|--------------------------------------|-------|-------------|--------|----------------------|--|--|--|--|--|
| 35 Incl. Exc. H/D, Camping Car | (230) | 94 - 12.01 | 635807 | | | | 345021 | | |
| Exc. H/D | (244) | 1.02 - 6.06 | 635806 | | | | 344283 | | |
| 35 Exc. H/D | (244) | 1.02 - 6.06 | 635807 | | | | 345041 | | |
| Incl. H/D, , , Exc. | | 4.06 - | | 335827 ²⁾ | | | 345700 ³⁾ 345701 ⁴⁾ | | |

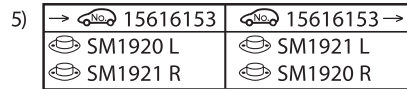
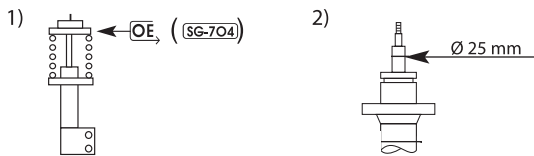

6) → 2.14

3) 345700 : OE p/n = 5206TS, 5206TW, 5206LT, 5206VA, 5206VS, 5206VT, 5206LY

4) 345701 : OE p/n = 5206TR, 5206TT, 5206TX, 5206LW, 5206VC, 5206VF, 5206PA, 5206VG, 5206VH, 5206PG, 5206TV, 5206NA

Jumpy / Dispatch

| | | | | | | | | | | |
|---------|-------|-------------|--------|--------|--|--|----------------------|-----------------------|--|--|
| → 7608 | (U6U) | 6.94 - 8.97 | 634928 | 334928 | | | 441106 ¹⁾ | 341238 ^{1)▼} | | |
| 7609 → | (U6U) | 9.97 - 8.00 | 634928 | 334928 | | | 441107 ²⁾ | 341239 ²⁾ | | |
| → 09792 | (U6U) | 9.00 - | 634928 | 334928 | | | 441107 ²⁾ | 341239 ²⁾ | | |

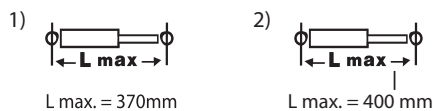



| MODEL FAHRZEUG MODELE | YEAR JAHR ANNEE | FRONT/VORNE/AVANT | | | | REAR/HINTEN/ARRIERE | | | |
|--|-----------------------|-----------------------------|--|--------------------------------|--|-----------------------------|-----------------------------|--------------------------------|--|
| | | PREMIUM Twin-tube Oil | EXCEL-G Twin-tube Gas | GAS-A-JUST Mono-tube Gas | | PREMIUM Twin-tube Oil | EXCEL-G Twin-tube Gas | GAS-A-JUST Mono-tube Gas | |
| Citroën Commercial (F) | | | | | | | | | |
| Jumpy / Dispatch | | | | | | | | | |
| Incl. Exc. H/D | 1.07 - 2.09 | | 339772 L 339771 R | | | | 345078 | | |
| | | 910124 | MB1907 SM1916 L SM1917 R | | | | | | |
| Exc. | 1.07 - 2.09 | | 339772 L 339771 R | | | | 345079 | | |
| | | 910124 | MB1907 SM1916 L SM1917 R | | | | | | |
| Incl. H/D, Exc. | 1.07 - 9.07 | | 339772 L 339771 R | | | | 345079 | | |
| | | 910124 | MB1907 SM1916 L SM1917 R | | | | | | |
| Incl. H/D, | 1.07 - 2.09 | | 339772 L 339771 R | | | | 345079 | | |
| | | 910124 | MB1907 SM1916 L SM1917 R | | | | | | |
| Incl. | 2.09 - | | 339772 L 339771 R | | | | 3448003 | | |
| | | 910124 | MB1907 SM1916 L SM1917 R | | | | | | |
| Jumpy / Dispatch / Spacetourer | | | | | | | | | |
| | (V_) 4.16 - | | 3348085 ¹⁾ 3348084 ²⁾ | | | | 3458001 | | |
| <div style="display: flex; justify-content: space-around;"> <div style="text-align: center;"> <p>1)</p> <p>282 mm</p> </div> <div style="text-align: center;"> <p>2)</p> <p>299 mm</p> </div> </div> | | | | | | | | | |
| Nemo combi , Nemo | | | | | | | | | |
| | 2.08 - 6.12 | | 334968 L ▼ 334967 R ▼ 339809 L 339808 R | | | | 349145 | | |
| | | 910112 | SM1821 L SM1822 R | | | | | | |



Cupra

| MODEL FAHRZEUG MODELE | YEAR JAHR ANNEE | FRONT/VORNE/AVANT | | | | REAR/HINTEN/ARRIERE | | | |
|--|-----------------------|-----------------------------|--|--------------------------------|--|-----------------------------|--|--------------------------------|--|
| | | PREMIUM Twin-tube Oil | EXCEL-G Twin-tube Gas | GAS-A-JUST Mono-tube Gas | | PREMIUM Twin-tube Oil | EXCEL-G Twin-tube Gas | GAS-A-JUST Mono-tube Gas | |
| Citroën Commercial (F) | | | | | | | | | |
| Nemo combi , Nemo | | | | | | | | | |
| | 7.12 - | | 334968 L ▼ 334967 R ▼ 339809 L 339808 R | | | | | | |
| | | | 910112 SM1821 L SM1822 R | | | | | | |
| Cupra (E) | | | | | | | | | |
| Formentor | | | | | | | | | |
| (KM7) 1.5 TSI, 2.0 TSI Bumper height : 127 mm, | 7.20 - | | | | | | | | |
| | | | | | | | 910332 | | |
| Dacia (R) | | | | | | | | | |
| Dokker , Dokker Express | | | | | | | | | |
| Incl. Stepway, H/D | 11.12 - | | 3338034 MB1504 SM1528 | | | | 344709 | | |
| Exc. | 12.12 - | | 3338034 MB1504 SM1528 | | | | 344709 | | |
| | 12.12 - | | 3338034 MB1504 SM1528 | | | | | | |
| Duster (HS) | | | | | | | | | |
| | 4.10 - 1.18 | | 338737 910009 MB1504 SM1528 | | | | 343827 ¹⁾ 910229 SM9916 | | |
| | 6.10 - 1.18 | | 338737 910009 MB1504 SM1528 | | | | 338738 SM1528 | | |
| 1) OE Ø 38,5 mm | | | | | | | | | |
| Duster (HM) | | | | | | | | | |
| 1.0 TCe 100, 1.2 TCe 125 1.3 TCe 130, 1.3 TCe 150 1.6 SCe 115, 1.6 SCe 115 LPG 1.5 dCi 90, 1.5 dCi 95, 1.5 dCi 110 1.5 dCi 155 | (HM) 10.17 - | | 338737 | | | | 343827 | | |



| MODEL FAHRZEUG MODELE | YEAR JAHR ANNEE | FRONT/VORNE/AVANT | | | | REAR/HINTEN/ARRIERE | | | |
|--|-----------------------|-----------------------------|-----------------------------|--------------------------------|------|-----------------------------|-----------------------------|--------------------------------|--|
| | | PREMIUM Twin-tube Oil | EXCEL-G Twin-tube Gas | GAS-A-JUST Mono-tube Gas | | PREMIUM Twin-tube Oil | EXCEL-G Twin-tube Gas | GAS-A-JUST Mono-tube Gas | |
| Dacia (R) | | | | | | | | | |
| Duster (HM) | | | | | | | | | |
| (4WD) 1.0 TCe 100, 1.2 TCe 125 1.3 TCe 130, 1.3 TCe 150, 1.6 SCe 115 1.5 dCi 110, 1.5 dCi 155 | (HM) | 10.17 - | | 338737 | | | 338738 | | |
| Lodgy | | | | | | | | | |
| ⊕ 5 Seater, 7 Seater Incl. Stepway Exc. | | 3.12 - | | 3338023 | | | 3448005 | | |
| | | | | | | | | | |
| ⊕ Incl. Stepway | | 3.12 - | | 3338034 | | | | | |
| | | | | | | | | | |
| Logan | | | | | | | | | |
| 1.2, 1.4, 1.4 MPI LPG 1.6, 1.6 MPI, 1.6 Bifuel, 1.6 Flexifuel 1.5 dCi | (LS) | 9.04 - | | 338112 | | | 343418 | | |
| | | | | | | | | | |
| Logan II | | | | | | | | | |
| Exc. | | 10.12 - | | 338759 | | | 343833 | | |
| | | | | | | | | | |
| 1.2, 1.5 dCi ⊕ | | 10.12 - | | 338749 | | | | | |
| | | | | | | | | | |
| Logan MCV I | | | | | | | | | |
| 1.6 1.4 MPI, 1.6 MPI, 1.6 MPI 16 V 1.6 Bifuel, 1.6 Flexifuel 1.5 dCi | (FS, KS, US) | 2.07 - | | 338713 | | | 343482 | | |
| | | | | | | | | | |
| Logan MCV II | | | | | | | | | |
| 0.9, 1.2, 1.5 dCi Exc. | | 2.13 - | | 338759 | | | 343836 | | |
| | | | | | | | | | |
| 1.2 LPG Exc. | | 2.13 - | | | | | 343418 | | |
| | | | | | | | | | |
| 0.9 1.5 dCi 1.2 | | 2.13 - | | 338749 | | | 343418 | | |
| | | | | | | | | | |
| Sandero | | | | | | | | | |
| 1.2 16V, 1.2 16V LPG, 1.4, 1.4 MPI LPG 1.5 dCi, 1.6, 1.6 16V Bifuel, 1.6 MPI Incl. Stepway | | 6.08 - | | 338713 | | | 348008▼ 343418 | | |
| | | | | | | | | | |



Dacia

| MODEL FAHRZEUG MODELE | YEAR JAHR ANNEE | FRONT/VORNE/AVANT | | | REAR/HINTEN/ARRIERE | | |
|-----------------------------|-----------------------|-----------------------------|-----------------------------|--------------------------------|-----------------------------|-----------------------------|--------------------------------|
| | | PREMIUM Twin-tube Oil | EXCEL-G Twin-tube Gas | GAS-A-JUST Mono-tube Gas | PREMIUM Twin-tube Oil | EXCEL-G Twin-tube Gas | GAS-A-JUST Mono-tube Gas |

Dacia (R)

Sandero II

| | | | | | | | | |
|--|---------|--|--|--------------------------|--|--|----------------|--|
| TCe 90, 1.2 1.5 dCi, 1.5 dCi 75 1.5 Blue dCi 75, 1.5 Blue dCi 95 Exc. Stepway, H/D, | 10.12 - | | 338759 | 910009 MB1504 SM1528 | | 343833 | 910229 SM9916 | |
| TCe 90 LPG Exc. Stepway | 9.15 - | | 338759 | 910009 MB1504 SM1528 | | 343836 | 910229 SM9916 | |
| 1.0 SCe 75 Exc. Stepway | 12.16 - | | 338749 | 910009 MB1504 SM1528 | | 343833 | 910229 SM9916 | |
| 1.2 LPG Exc. Stepway | 10.12 - | | 338759 | 910009 MB1504 SM1528 | | 343833 ³⁾ 343836 ⁴⁾ | 910229 SM9916 | |
| 1.2 1.5 dCi, 1.5 dCi 75 1.5 Blue dCi 75, 1.5 Blue dCi 95 H/D Exc. Stepway, | 10.12 - | | 338759 ¹⁾ 338749 ²⁾ | 910009 MB1504 SM1528 | | 343833 | SM9916 | |
| 1.2 1.5 dCi, 1.5 dCi 75 1.5 Blue dCi 75, 1.5 Blue dCi 95 Exc. Stepway, H/D | 10.12 - | | 338749 | 910009 MB1504 SM1528 | | 343833 | SM9916 | |

Sandero Stepway II

| | | | | | | | | |
|--|---------|--|--|--------------------------|--|--------|--|--|
| TCe 90, TCe 90 LPG 1.2 (55 kW), 1.2 LPG 1.5 dCi, 1.5 dCi 75, 1.5 Blue dCi 75 | 10.12 - | | 3338042 | 910009 MB1504 SM1528 | | 343834 | | |
| 1.5 Blue dCi 95 Exc. H/D, | 8.18 - | | 338759 | 910009 MB1504 SM1528 | | 343833 | | |
| 1.5 Blue dCi 95 H/D Exc. | 8.18 - | | 338759 ¹⁾ 338749 ²⁾ | 910009 MB1504 SM1528 | | 343833 | | |

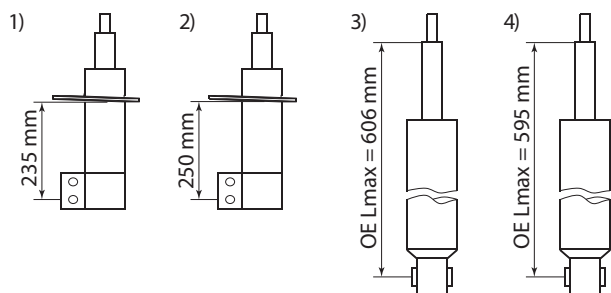



| MODEL FAHRZEUG MODELE | YEAR JAHR ANNEE | FRONT/VORNE/AVANT | | | | REAR/HINTEN/ARRIERE | | | |
|--|---|--|-----------------------------|--------------------------------|--|-----------------------------|-----------------------------|--------------------------------|--------|
| | | PREMIUM Twin-tube Oil | EXCEL-G Twin-tube Gas | GAS-A-JUST Mono-tube Gas | | PREMIUM Twin-tube Oil | EXCEL-G Twin-tube Gas | GAS-A-JUST Mono-tube Gas | |
| Daewoo (KO) → Chevrolet - Daewoo (KO) | | | | | | | | | |
| Daihatsu (J) | | | | | | | | | |
| Sander Stepway II | | | | | | | | | |
| 1.5 Blue dCi 95 Exc. H/D | 8.18 - | | 338749 | | | | 343833 | | |
| | | ☺☺☺☺ 910009 | ☺ MB1504 ☺ SM1528 | | | | | | ⊥ ○ |
| Applause | | | | | | | | | |
| 1.6 (2WD) Incl. Hard sus., Auto adjust sus. | (A 101) 6.89 - 7.97 | | 333171 L▼ 333170 R▼ | | | | 333173 L 333172 R | | |
| 1.6 (4WD) Incl. Hard sus., Auto adjust sus. | (A 111) 6.89 - 7.97 | | 333171 L▼ 333170 R▼ | | | | | | |
| Charade | | | | | | | | | |
| 1000 Exc. Turbo, GT-ti (G100) 1000 Diesel, Turbo Diesel (G101) 1300 ⊖ R-Grade Package (G102) | 1.87 - 2.93 1.87 - 2.93 9.88 - 2.93 | 632045 L 632044 R | 332044 L 332043 R | | | 632090 L 632089 R | 332067 L▼ 332066 R▼ | | |
| | | | | | | ☺☺☺☺ 913138▼ | | | |
| 1000 Turbo Exc. GT-ti (G100) 1300 ⊕ R-Grade Package (G102) | 1.87 - 8.88 9.88 - 2.93 | | 332044 L 332043 R | | | | 332067 L▼ 332066 R▼ | | |
| | | | | | | ☺☺☺☺ 913138▼ | | | |
| 1300 (2WD) (G102) | 5.89 - 2.93 | 632045 L 632044 R | 332044 L 332043 R | | | 633132 L▼ 633131 R▼ | | | |
| 1000 GT-ti (2WD) (G100) | 1.87 - 2.93 | | 332044 L 332043 R | | | | | | |
| 1000 (G202) 1300 (G200) 1500 (G203) Incl. ABS | 5.93 - 6.96 3.93 - 6.96 6.94 - 6.96 | | 332079 L▼ 332078 R▼ | | | 633176 L▼ 633175 R▼ | 333200 L▼ 333199 R▼ | | |
| 1000 (G202) 1300 (G200) Incl. ABS | 6.96 - | | 333245 L 333244 R | | | | 333247 L 333246 R | | |
| 1500 (G203) Incl. ABS | 6.96 - | | 333245 L 333244 R | | | | 333247 L 333246 R | | |
| 1600 GTI (G201) Incl. ABS | 3.93 - | | 332079 L▼ 332078 R▼ | | | | 333200 L▼ 333199 R▼ | | |
| Charmant | | | | | | | | | |
| | (A 10, 20) (A 30, 40) | 11.74 - 2.78 2.77 - 7.81 | 663031 | 363018 | | | | | |
| 1300 1500 | (A 35) (A 55) | 10.81 - 8.83 | 663032 | | | | 343036 | | ⊥ ○ |
| 1600 1300 1600 | (A 45) (A 35) (A 60) | 10.81 - 8.83 9.83 - 88 9.83 - 88 | 665022▼ | 365015 | | | 343036 | | ⊥ ○ |





| MODEL FAHRZEUG MODELE | YEAR JAHR ANNEE | FRONT/VORNE/AVANT | | | | REAR/HINTEN/ARRIERE | | | |
|---|-----------------------|-----------------------------|-----------------------------|--------------------------------|--|-----------------------------|-----------------------------|--------------------------------|--|
| | | PREMIUM Twin-tube Oil | EXCEL-G Twin-tube Gas | GAS-A-JUST Mono-tube Gas | | PREMIUM Twin-tube Oil | EXCEL-G Twin-tube Gas | GAS-A-JUST Mono-tube Gas | |
| Daihatsu (J) | | | | | | | | | |
| Charmant | | | | | | | | | |
| ALL (A 10V, 20V, 30V) | 12.74 - 2.78 | 663031 | | | | | | | |
| 1300 (A 30V) 1600 (A 40V) | 8.79 - 7.81 | 663031 | | | | | | | |
| Cuore / Domino | | | | | | | | | |
| 840 cc (L80) Exc. | 8.85 - 7.90 | | | | | 442032 | | | |
| 850 cc (L201) | 8.90 - 8.94 | 632098 L 632097 R | | | | 442033 | | | |
| 850 cc (L501) | 8.94 - 10.98 | 632100 L 632099 R | | | | 442034 | | | |
| 1000 cc Incl. ABS (L701) | 10.98 - 5.03 | | 332103 L 332102 R | | | 442038▼ | 342022 | | |
| 1.0 Charade (L251S) | (L251) 5.03 - 12.03 | | 332119 L 332118 R | | | | 342028 | | |
| 1.0 Charade (L251S) | (L251) 12.03 - | | 332119 L 332118 R | | | | 343428 | | |
| 1.0 Incl. | 4.07 - | | 332138 L 332137 R | | | | 342032 | | |
| Delta (Truck) | | | | | | | | | |
| Delta (V 10T) | 8.77 - 9.84 | 444064 | | | | 444061 | | | |
| Feroza / Sportrak | | | | | | | | | |
| F 300 Exc. | 10.88 - 12.97 | | 344105 | | | | 343238 | 553156▼ | |
| F 310 Exc. | 5.92 - 12.97 | | 344105 | | | | 343275 | | |
| Gran Move | | | | | | | | | |
| 1500 (G303) 1600 (G301) Incl. ABS | 8.95 - 7.98 7.98 - | | 333245 L 333244 R | | | | 333247 L 333246 R | | |
| Hijet | | | | | | | | | |
| 1000 (S86) | 7.86 - 12.92 | 633118 L 633117 R | | | | 443307 | | | |
| 1.0, 1.0 i (S85) | 12.92 - | 633118 L 633117 R | | | | | | | |
| Materia | | | | | | | | | |
| 1.3 1.5 Exc. | 10.06 - 10.06 - | | 338016 L 338015 R | | | | 343406 | | |



| MODEL FAHRZEUG MODELE | YEAR JAHR ANNEE | FRONT/VORNE/AVANT | | | | REAR/HINTEN/ARRIERE | | | |
|---|-----------------------|-----------------------------|-----------------------------|--------------------------------|--|-----------------------------|-----------------------------|--------------------------------|--|
| | | PREMIUM Twin-tube Oil | EXCEL-G Twin-tube Gas | GAS-A-JUST Mono-tube Gas | | PREMIUM Twin-tube Oil | EXCEL-G Twin-tube Gas | GAS-A-JUST Mono-tube Gas | |
| Daihatsu (J) | | | | | | | | | |
| Move | | | | | | | | | |
| 850 cc (L601) | 8.95 - 10.98 | | 333249 L 333248 R | | | | 342021 | | |
| 1000 cc (L901) | 10.98 - | | 332103 L 332102 R | | | | 342022 | | |
| Sirion / Storia | | | | | | | | | |
| (2WD) 1.0 (M100) | 1.98 - 4.99 | | 332105 L 332104 R | | | | 342022 | | |
| (2WD) 1.0 → M100-538945 (M100) | 4.99 - | | 332105 L 332104 R | | | | 342022 | | |
| (2WD) 1.0 M100-538946 → 1.3 (M100) (M101) | - 5.00 - 3.05 | | 332111 L 332110 R | | | | 342022 | | |
| (4WD) 1.0 (M110) | 1.98 - 4.99 | | 332105 L 332104 R | | | | 342023 | | |
| (4WD) 1.0 → M110-542039 (M110) | 4.99 - | | 332105 L 332104 R | | | | 342023 | | |
| (4WD) 1.0 M110-542040 → 1.3 (M110) (M111) | - 5.00 - 3.05 | | 332111 L 332110 R | | | | 342023 | | |
| 1.0 i (2WD) 1.3 i (2WD) 1.5 i (2WD) (M300) (M301) | 4.05 - | | 332120 | | | | 343406 | | |
| Taft / Rocky / Wild Cat / Four Track | | | | | | | | | |
| (F 10, 20, 50) | 8.78 - 84 | 443152 | | | | 443150 | | 553143 | |
| (F 25, 55) | 11.79 - 84 | 443152 | | | | | | 553096 | |
| (F 60) | 10.82 - 84 | 443177 | | 553145▼ | | 443150 | | 553143 | |
| Exc. (F 70, F 75, F 80, F 85) | 4.84 - 4.93 | | 343186 | 553113▼ | | | 343186 | 553113▼ | |
| Exc. (F 77, F 87) | 4.84 - 4.93 | | 343186 | 553113▼ | | | | 553096 | |
| 2.2 l (F 98) 2.8 D, 2.8 TD (F 73) 2.8 D, 2.8 TD (F 78) Exc. | 5.93 - | | 344257 | | | | 344258 | | |
| Terios | | | | | | | | | |
| 1300 (4WD) Incl. ABS (J100) | 3.97 - 9.98 | 634111 L 634110 R | 339022 L 339021 R | | | | 342024 | | |



DS

| MODEL FAHRZEUG MODELE | YEAR JAHR ANNEE | FRONT/VORNE/AVANT | | | | REAR/HINTEN/ARRIERE | | | |
|-----------------------------|-----------------------|-----------------------------|-----------------------------|--------------------------------|--|-----------------------------|-----------------------------|--------------------------------|--|
| | | PREMIUM Twin-tube Oil | EXCEL-G Twin-tube Gas | GAS-A-JUST Mono-tube Gas | | PREMIUM Twin-tube Oil | EXCEL-G Twin-tube Gas | GAS-A-JUST Mono-tube Gas | |

Daihatsu (J)

| Terios | | | | | | | | | | |
|-----------|--------|---------------|----------|----------|--|--|--|--------|--|--|
| 1300 | (J100) | 9.98 - 5.00 | 634111 L | 339022 L | | | | 343483 | | |
| 1300 | (J102) | 5.00 - 12.00 | 634110 R | 339021 R | | | | | | |
| 1300 | (J122) | 5.00 - 12.01 | | | | | | | | |
| Incl. ABS | | | | | | | | | | |
| | | 12.01 - 12.05 | 633266 L | 333434 L | | | | 343483 | | |
| 1300 | | | 633265 R | 333433 R | | | | | | |
| Incl. ABS | | | | | | | | | | |

| Terios II | | | | | | | | | | |
|-----------|--------|--------------|--|--------|--|--|--|--------|--|--|
| 1.3 VVT | (J211) | 5.06 - 10.08 | | 333496 | | | | 343441 | | |
| 1.5 VVT | (J200) | | | | | | | | | |
| 1.5 VVT | (J210) | | | | | | | | | |
| Incl. ABS | | | | | | | | | | |

| Trevis | | | | | | | | | | |
|--------|--|--------|--|----------|--|--|--|--------|--|--|
| 1.0 | | 6.06 - | | 332140 L | | | | 348026 | | |
| | | | | 332139 R | | | | | | |

| YRV | | | | | | | | | | |
|----------|------|---------|--|----------|--|--|--|--------|--|--|
| | (M2) | 10.00 - | | 332111 L | | | | 342022 | | |
| 1.0, 1.3 | | | | 332110 R | | | | | | |
| | (M2) | 10.00 - | | 332111 L | | | | 342023 | | |
| 1.3 | | | | 332110 R | | | | | | |

Dodge (US) → Chrysler (US)

| | | | | | | | | | | |
|--|--|--|--|--|--|--|--|--|--|--|
| | | | | | | | | | | |
|--|--|--|--|--|--|--|--|--|--|--|

DS (F)

| DS 3 | | | | | | | | | | |
|------------------------|------------|-------------|--|------------------------|--|--|--|---------|--|--|
| | (SA_, SB_) | 4.15 - 7.19 | | 339801 L ¹⁾ | | | | 3448000 | | |
| Incl. Performance Line | | | | 339800 R ¹⁾ | | | | | | |
| Exc. Performance | | | | 339795 L ²⁾ | | | | | | |
| | | | | 339794 R ²⁾ | | | | | | |
| | | | | 339708 L ³⁾ | | | | | | |
| | | | | 339707 R ³⁾ | | | | | | |
| | | | | 910259 | | | | | | |
| | | | | MB1901 | | | | | | |
| | | | | SM1553 | | | | | | |

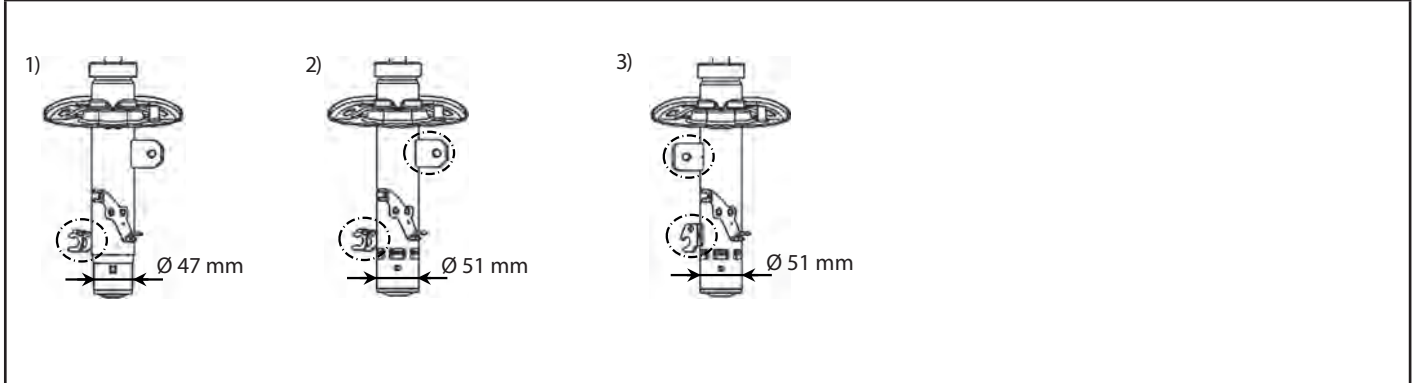



| MODEL FAHRZEUG MODELE | YEAR JAHR ANNEE | FRONT/VORNE/AVANT | | | | REAR/HINTEN/ARRIERE | | | |
|--|-----------------------|-----------------------------|-----------------------------|--------------------------------|--|-----------------------------|-----------------------------|--------------------------------|--|
| | | PREMIUM Twin-tube Oil | EXCEL-G Twin-tube Gas | GAS-A-JUST Mono-tube Gas | | PREMIUM Twin-tube Oil | EXCEL-G Twin-tube Gas | GAS-A-JUST Mono-tube Gas | |
| DS (F) | | | | | | | | | |
| DS 3 | | | | | | | | | |
| (SA_, SB_) ⊕ Performance Exc. Performance Line | 7.15 - 7.19 | | 3348013 L 3348012 R | | | | | | |
| | | 910259 | | | | | | | |
| DS 4 | | | | | | | | | |
| Incl. Sport sus., H/D, Crossback Exc. 2.0 BlueHDi | 7.15 - | | 339829 L 339828 R | | | | 345085 | | |
| | | 910067 | | | | 910095 | | | |
| 2.0 BlueHDi Incl. Sport sus., H/D, Crossback | 7.15 - | | | | | | 345085 | | |
| | | 910067 | | | | 910095 | | | |
| DS 5 | | | | | | | | | |
| | 4.15 - | | 3348038 L 3348037 R | | | | 349156 ¹⁾ | | |
| | | 910198 ²⁾ | | | | | | | |

1) Exc. Hybrid 2) OE = 5033C8 3) → 13103 4) 13104 →
 Bumper height : 87 mm

Fiat (I)

124, 125, 126

| | | | | | | | | | |
|-----------------|-----------|--------|---------|--|--|--------|--------|---------|--|
| 124 S, T | 68 - 76 | 443007 | 343072 | | | | 343017 | | |
| 124 Familiare | 66 - 2.75 | 443007 | 343072 | | | 443123 | 343098 | 553005▼ | |
| 126 Exc. Bis | 72 - | 443005 | 343070▼ | | | 443006 | | | |

131

| | | | | | | | | | |
|---------------------|--------------|--|--|--|--|--|--------|--|--|
| → 4214186 | 74 - 2.78 | | | | | | 343017 | | |
| 4214186 → | 3.78 - 2.81 | | | | | | 343017 | | |
| | 3.81 - 12.83 | | | | | | 343017 | | |
| Diesel → 1012811 | 7.78 - 2.81 | | | | | | 343017 | | |
| Diesel 1012811 → | 3.81 - 12.83 | | | | | | 343017 | | |



| MODEL FAHRZEUG MODELE | YEAR JAHR ANNEE | FRONT/VORNE/AVANT | | | | REAR/HINTEN/ARRIERE | | | | | | | | | | | | | | | |
|--|---|-----------------------------|-----------------------------|--------------------------------|--|-----------------------------|-----------------------------|--------------------------------|--|-----|-------|--------|---------------|----------------|-------|--------|---------------|-----|-------|--------|---------------|
| | | PREMIUM Twin-tube Oil | EXCEL-G Twin-tube Gas | GAS-A-JUST Mono-tube Gas | | PREMIUM Twin-tube Oil | EXCEL-G Twin-tube Gas | GAS-A-JUST Mono-tube Gas | | | | | | | | | | | | | |
| Fiat (I) | | | | | | | | | | | | | | | | | | | | | |
| 132 / Argenta | | | | | | | | | | | | | | | | | | | | | |
| 132 Argenta | 72 - 86 81 - 86 | 443013 | | | | | | | | | | | | | | | | | | | |
| 500, D, F, L, Nuova | | | | | | | | | | | | | | | | | | | | | |
| 500, D, F, L, Nuova | 59 - 76 | 443005 | 343070 ▼ | | | 443006 | | | | | | | | | | | | | | | |
| 500, 500 C | | | | | | | | | | | | | | | | | | | | | |
| 0.9 (312) 1.2, 1.2 LPG 1.4 16V 1.3 D Multijet Exc. Abarth | 9.09 - 10.07 - 10.07 - 10.07 - | | 333767 L 333766 R | | | | 343488 | | | | | | | | | | | | | | |
| 1.4 Abarth (2WD) | 8.08 - | | | | | | | | | | | | | | | | | | | | |
| <p>1) <table border="1"> <tr> <td>1.2</td> <td>51 kW</td> <td>10.07-</td> <td>→ TEL 418096</td> </tr> <tr> <td>1.3 D Multijet</td> <td>55 kW</td> <td>10.07-</td> <td>→ TEL 418096</td> </tr> <tr> <td>1.4</td> <td>74 kW</td> <td>10.07-</td> <td>→ TEL 418096</td> </tr> </table> </p> <p>2) 500</p> <p>3) 500 C Exc. 0.9 (48 kW, 59 kW)</p> | | | | | | | | | | 1.2 | 51 kW | 10.07- | → TEL 418096 | 1.3 D Multijet | 55 kW | 10.07- | → TEL 418096 | 1.4 | 74 kW | 10.07- | → TEL 418096 |
| 1.2 | 51 kW | 10.07- | → TEL 418096 | | | | | | | | | | | | | | | | | | |
| 1.3 D Multijet | 55 kW | 10.07- | → TEL 418096 | | | | | | | | | | | | | | | | | | |
| 1.4 | 74 kW | 10.07- | → TEL 418096 | | | | | | | | | | | | | | | | | | |
| 500 L | | | | | | | | | | | | | | | | | | | | | |
| 0.9, 0.9 Natural Power (351_, 352_) 1.4 (70 kW, 88 kW), 1.4 LPG 1.3 D Multijet, 1.6 D Multijet Exc. 7 seater | 9.12 - | | 3348097 L 3348096 R | | | | 5538000 | | | | | | | | | | | | | | |
| | | | | | | | | | | | | | | | | | | | | | |
| 0.9, 0.9 Natural Power (351_, 352_) 1.4 (70 kW, 88 kW), 1.4 LPG 1.3 D Multijet, 1.6 D Multijet ⊕ 7 seater | 9.12 - | | 3348097 L 3348096 R | | | | 3458002 | | | | | | | | | | | | | | |
| | | | | | | | | | | | | | | | | | | | | | |
| 500X | | | | | | | | | | | | | | | | | | | | | |
| (2WD) (334_) 1.0 (88 kW), 1.4 (100 kW, 103 kW) 1.4 LPG, 1.6 1.3 D Multijet, 1.6 D Multijet | 9.14 - | | 3348077 L 3348076 R | | | | 3348079 L 3348078 R | | | | | | | | | | | | | | |
| | | | | | | | | | | | | | | | | | | | | | |
| (2WD) (334_) 1.3 (110 kW) | 9.18 - | | | | | | 3348079 L 3348078 R | | | | | | | | | | | | | | |
| | | | | | | | | | | | | | | | | | | | | | |
| (4WD) (334_) | 9.14 - | | | | | | | | | | | | | | | | | | | | |
| | | | | | | | | | | | | | | | | | | | | | |
| Barchetta (183) | | | | | | | | | | | | | | | | | | | | | |
| 1.8 (183) | 3.95 - | | 334697 | | | | | 554086 | | | | | | | | | | | | | |



| MODEL FAHRZEUG MODELE | YEAR JAHR ANNEE | FRONT/VORNE/AVANT | | | | REAR/HINTEN/ARRIERE | | | |
|--|-----------------------|------------------------------|--|--------------------------------|--|-----------------------------|-----------------------------|--------------------------------|--|
| | | PREMIUM Twin-tube Oil | EXCEL-G Twin-tube Gas | GAS-A-JUST Mono-tube Gas | | PREMIUM Twin-tube Oil | EXCEL-G Twin-tube Gas | GAS-A-JUST Mono-tube Gas | |
| Fiat (I) | | | | | | | | | |
| Bravo, Brava (182) | | | | | | | | | |
| 1.4 → 4085697 | (182) | 95 - 96 | | 333749 | | | 344115 | 554077 | |
| | | | 913112 SM1806 | | | | | | |
| 1.4 4085698 → | (182) | 1.96 - 01 | | 333750 | | | 344115 | 554077 | |
| | | | 913112 SM1806 | | | | | | |
| 1.2, 1.6 | (182) | 95 - 01 | | 333750 | | | 344115 | 554077 | |
| | | | 913112 SM1806 ¹⁾ SM1802 L ²⁾ ▼ SM1803 R ²⁾ ▼ | | | | | | |
| 1.9 D, 2.0 D | (182) | 95 - 01 | | 333750 | | | 344115 | 554077 | |
| | | | 913112 SM1806 | | | | | | |
| 1.8, 1.9 TD, 1.9 JTD | (182) | 95 - 01 | | 334849 | | | 344115 | 554077 | |
| | | | 913112 SM1806 | | | | | | |
| 2.0 20V Exc. Sport sus. | (182) | 95 - 01 | | 334696▼ | | | | 554077 | |
| | | | 913112 SM1806 | | | | | | |
| 2.0 20V ⊕ Sport sus. | (182) | 95 - 01 | | | | | | 554077 | |
| | | | 913112 SM1802 L▼ SM1803 R▼ | | | | | | |
| 1) Bravo | | 2) Brava | | | | | | | |
| Bravo II | | | | | | | | | |
| 1.4, 1.4 T-Jet, 1.4 LPG 1.6 JTD, 1.9 JTD 8V 1.9 JTD 16V, 2.0 JTD | (198) | 4.07 - 11.06 - 12.08 - | | 339731 | | | 343397 | | |
| | | | 910092 SM1816 | | | | 910013 SM9807 | | |
| 1.9 JTD 16V, 2.0 JTD | (198) | 4.07 - 11.08 | | 339732 | | | 343397 | | |
| | | | SM1816 | | | | 910013 SM9807 | | |
| Cinquecento (170) | | | | | | | | | |
| 0.7, 0.9 | (170) | 92 - 3.98 | 633731 | 333731 | | 441098 | 341189 | | |
| | | | | 323731 | | | 351019 | | |
| | | | 915809▼ SM1813 913268 | | | | | | |
| 1.1 Incl. Sporting | (170) | 94 - 3.98 | | 333731 | | | 341189 | | |
| | | | | 323731 | | | 351019 | | |
| | | | 915809▼ SM1813 913268 | | | | | | |
| Coupé (175) | | | | | | | | | |
| 1.8 16V, 2.0 16V, 2.0 20V | (175) | 94 - 02 | | 334667 | | | 344115 | 554077 | |
| | | | | | | | | | |
| 2.0 Turbo | (175) | 94 - 02 | | | | | 344115 | 554077 | |
| | | | | | | | | | |



Fiat

| MODEL FAHRZEUG MODELE | YEAR JAHR ANNEE | FRONT/VORNE/AVANT | | | | REAR/HINTEN/ARRIERE | | | |
|--|-----------------------|-------------------------------------|-----------------------------|--------------------------------|--|-----------------------------|-----------------------------|--------------------------------|--|
| | | PREMIUM Twin-tube Oil | EXCEL-G Twin-tube Gas | GAS-A-JUST Mono-tube Gas | | PREMIUM Twin-tube Oil | EXCEL-G Twin-tube Gas | GAS-A-JUST Mono-tube Gas | |
| Fiat (I) | | | | | | | | | |
| Croma (154) | | | | | | | | | |
| 1.6, 2.0 1.9 TD, 2.5 D, 2.5 TD | (154) | 12.85 - 10.86 | 334804 | | | | | | |
| | | | 913113 ▼ 910085 | | | | | | |
| | | | SM1807 ▼ | | | | | | |
| 2.0 i.e., 2.0 i.e. Turbo | (154) | 12.85 - 10.86 | 334804 | | | | | | |
| | | | 913113 ▼ 910085 | | | | | | |
| | | | | | | | | | |
| 1.6, 2.0 1.9 TD, 2.5 D, 2.5 TD 2.0 TD | (154) | 11.86 - 96 11.86 - 96 88 - 96 | 334804 | | | 334801 | | | |
| | | | 913113 ▼ 910085 | | | 913113 ▼ 910085 | | SM9803 | |
| | | | | | | | | | |
| 2.0 i.e. 2.0 i.e. Turbo | (154) | 11.86 - 96 | 334804 | | | 334801 | | | |
| | | | 913113 ▼ 910085 | | | 913113 ▼ 910085 | | SM9803 | |
| | | | | | | | | | |
| Croma II (194) | | | | | | | | | |
| 1.8 16V, 2.2 16V 1.9 JTD, 2.4 JTD | (194) | 6.05 - | 334633 L ▼ 334632 R ▼ | | | | | 553357 | |
| | | | 3348050 L 3348049 R | | | | | | |
| | | | 910069 | | | | | | |
| | | | SM1311 | | | | | | |
| Doblo → Fiat Commercial | | | | | | | | | |
| | | | | | | | | | |
| Freemont (JC) | | | | | | | | | |
| | (JC) | 8.11 - | 339250 L 339249 R | | | 340093 | | | |
| | | | | | | | | | |
| | (JC) | 8.11 - | 339250 L 339249 R | | | | | | |
| | | | | | | | | | |
| Idea (135) | | | | | | | | | |
| 1.2 16V, 1.4 8V, 1.4 16V, 1.4 LPG 1.3 JTD, 1.6 JTD, 1.9 JTD | (135) | 03 - | 334691 | | | 343414 | | | |
| | | | 910014 | | | | | | |
| | | | SM1811 | | | | | | |
| Linea (323) | | | | | | | | | |
| 1.3 D Multijet, 1.4 8V | (323) | 6.07 - | 339775 L 339774 R | | | 348034 | | | |
| | | | 910112 | | | | | | |
| | | | | | | | | | |
| | | | SM1821 L SM1822 R | | | | | | |
| 1.4 T-Jet, 1.6 D Multijet | (323) | 6.07 - | | | | 348034 | | | |
| | | | 910112 | | | | | | |
| | | | | | | | | | |
| | | | SM1821 L SM1822 R | | | | | | |
| Marea (185) | | | | | | | | | |
| 1.2 16V, 1.4, 1.6, 1.8 1.9 TD -75, 100 1.9 JTD | (185) | 9.96 - 12.07 | 334861 | | | 344115 | | 554077 | |
| | | | 913116 | | | | | | |
| | | | SM1806 | | | | | | |



| MODEL FAHRZEUG MODELE | YEAR JAHR ANNEE | FRONT/VORNE/AVANT | | | | REAR/HINTEN/ARRIERE | | | |
|--|--|-----------------------------|-----------------------------|--------------------------------|--|-----------------------------|-----------------------------|--------------------------------|--|
| | | PREMIUM Twin-tube Oil | EXCEL-G Twin-tube Gas | GAS-A-JUST Mono-tube Gas | | PREMIUM Twin-tube Oil | EXCEL-G Twin-tube Gas | GAS-A-JUST Mono-tube Gas | |
| Fiat (I) | | | | | | | | | |
| Marea (185) | | | | | | | | | |
| 2.0 20V, 2.4 TD, 2.4 JTD (185) | 9.96 - 12.07 | | 334862 | | | | | 554077 | |
| | | 913116 | SM1806 | | | | | | |
| Multipla (186) | | | | | | | | | |
| 1.6, 1.9 TD, 1.9 JTD Exc. Bi power, Blu power (186) | 10.98 - | | 334863 | | | | 344115 | 554077 | |
| | | 910011 | MB1907 SM1819 | | | | | | |
| Bi power Blu power (186) | 10.98 - | | | | | | 344115 | 554077 | |
| | | 910011 | MB1907 SM1819 | | | | | | |
| Palio , Siena (178) | | | | | | | | | |
| Incl. ABS | 4.96 - 01 | | 333942 | | | | 349052 | | |
| | | 910201 | SM1815 L SM1814 R | | | | | | |
| | 3.01 - | | | | | | 349052 | | |
| | | 910201 | SM1815 L SM1814 R | | | | | | |
| Palio Weekend | | | | | | | | | |
| 1.2 (44 kW) (178DYA1A) 1.2 (54 kW) (178DX_) 1.4 (178DX_) 1.6 16V (74 kW) (178DX_) 1.6 16V (76 kW) (178DYC1A_) 1.7 TD (178DX_) Incl. Stability Control System (ESP/DSC) | 7.97 - 10.04 4.96 - 2.01 7.97 - 8.01 4.96 - 2.01 2.01 - 4.96 - 3.01 | | 333942 | | | | 344115 | 554077 | |
| | | 910201 | SM1815 L SM1814 R | | | | | | |
| 1.2 (44 kW) (178AYA1A08) 1.2 (50 kW) (178BX_) Incl. Stability Control System (ESP/DSC) | 7.97 - 10.04 6.99 - 10.02 | | 333942 | | | | | | |
| | | 910201 | SM1815 L SM1814 R | | | | | | |
| 1.9 D (178DY_) | 3.01 - | | | | | | 344115 | 554077 | |
| | | 910201 | SM1815 L SM1814 R | | | | | | |
| 1.2 (59 kW) (178DY_) 1.5 exc. , Adventure (178DY_) 1.6 16V (76 kW) (178DYC1A_) 1.9 JTD (178DY_) | 9.01 - 2.02 - 2.01 - 9.01 - | | | | | | 345088 | | |
| | | 910201 | SM1815 L SM1814 R | | | | | | |
| Panda (141) | | | | | | | | | |
| | (141) 2.80 - 1.86 | 633951 | 333951 | | | 441038 | 341212 | | |
| | | 910084 | SM1804 | | | | | | |
| | (141) 2.86 - 8.03 | 633951 | 333951 | | | 441077 | 341209 | | |
| | | 910084 | SM1804 | | | | | | |
| | (141) 87 - 8.03 | 631600 | | | | 441094 | 341210 | | |
| | | 910084 | SM1804 | | | | | | |



| MODEL FAHRZEUG MODELE | YEAR JAHR ANNEE | FRONT/VORNE/AVANT | | | | REAR/HINTEN/ARRIERE | | | |
|-----------------------------|-----------------------|-----------------------------|-----------------------------|--------------------------------|--|-----------------------------|-----------------------------|--------------------------------|--|
| | | PREMIUM Twin-tube Oil | EXCEL-G Twin-tube Gas | GAS-A-JUST Mono-tube Gas | | PREMIUM Twin-tube Oil | EXCEL-G Twin-tube Gas | GAS-A-JUST Mono-tube Gas | |

Fiat (I)

Panda, Panda Classic (169)

| | | | | | | | | | |
|---|-------|-------------|--------|--|--|--|--------|--|--|
| [2WD] 1.1, 1.2 (44 kW), 1.2 LPG (51 kW) 1.3 D Multijet (51 kW) | (169) | 9.03 - | | 333764 L 333763 R | | | 343415 | | |
| | | | 910014 | SM1810 ¹⁾ SM1811 ¹⁾ SM1812 ¹⁾ ▼ | | | | | |
| [2WD] 1.2 (51 kW) Exc. | (169) | 3.10 - 8.13 | | 333764 L 333763 R | | | 343415 | | |
| | | | 910014 | SM1810 ¹⁾ SM1811 ¹⁾ SM1812 ¹⁾ ▼ | | | | | |
| [2WD] 1.2 (51 kW) ⊕ | (169) | 3.10 - 8.13 | | 333764 L 333763 R | | | 348005 | | |
| | | | 910014 | SM1810 ¹⁾ SM1811 ¹⁾ SM1812 ¹⁾ ▼ | | | | | |
| [2WD] 1.2 LPG (44 kW), 1.2 Natural Power | (169) | 1.07 - | | 339740 L 339739 R | | | 348005 | | |
| | | | 910014 | SM1810 ¹⁾ SM1811 ¹⁾ SM1812 ¹⁾ ▼ | | | | | |
| [2WD] 1.4 | (169) | 10.06 - | | 339738 L 339737 R | | | 343486 | | |
| | | | 910014 | SM1810 ¹⁾ SM1811 ¹⁾ SM1812 ¹⁾ ▼ | | | | | |
| [2WD] 1.4 Natural Power | (169) | 9.10 - 8.13 | | 333764 L 333763 R | | | 348005 | | |
| | | | 910014 | SM1810 ¹⁾ SM1811 ¹⁾ SM1812 ¹⁾ ▼ | | | | | |
| [2WD] 1.3 D Multijet (55 kW) Exc. Reduced Capacity | (169) | 6.06 - 8.13 | | 333764 L 333763 R | | | 348005 | | |
| | | | 910014 | SM1810 ¹⁾ SM1811 ¹⁾ SM1812 ¹⁾ ▼ | | | | | |
| [2WD] 1.3 D Multijet (55 kW) ⊕ Reduced Capacity | (169) | 6.06 - 8.13 | | 333764 L 333763 R | | | 343415 | | |
| | | | 910014 | SM1810 ¹⁾ SM1811 ¹⁾ SM1812 ¹⁾ ▼ | | | | | |

1)

| | KYB |
|--|-------------------|
| 1.1, 1.2 (44 kW), 1.4, 1.3 D Multijet | SM1810 |
| 1.2 (51 kW), 1.2 4x4, 1.2 LPG, 1.3 D Multijet 4x4, 1.3 JTD Multijet 4x4 | SM1811 |
| 1.2 Bipower, 1.2 Natural Power, 1.4 Natural Power | SM1812▼ SM1810 |

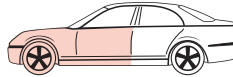

| MODEL FAHRZEUG MODELE | YEAR JAHR ANNEE | FRONT/VORNE/AVANT | | | | REAR/HINTEN/ARRIERE | | | | | | | | | | | |
|---|-----------------------|-------------------------------------|-----------------------------|--|--|-----------------------------|--|--------------------------------|--|--|------------|---------------------------------------|--------|--|--------|--|-------------------|
| | | PREMIUM Twin-tube Oil | EXCEL-G Twin-tube Gas | GAS-A-JUST Mono-tube Gas | | PREMIUM Twin-tube Oil | EXCEL-G Twin-tube Gas | GAS-A-JUST Mono-tube Gas | | | | | | | | | |
| Fiat (I) | | | | | | | | | | | | | | | | | |
| Panda, Panda Classic (169) | | | | | | | | | | | | | | | | | |
| (4WD) 1.2, 1.3 JTD Multijet (55 kW) | (169) | 9.10 - | | 339740 L 339739 R | | | 348005 | | | | | | | | | | |
| | | | 910014 | SM1810 ¹⁾ SM1811 ¹⁾ SM1812 ¹⁾ ▼ | | | | | | | | | | | | | |
| (4WD) 1.3 D Multijet (51 kW) | (169) | 10.04 - | | 339740 L 339739 R | | | 343415 | | | | | | | | | | |
| | | | 910014 | SM1810 ¹⁾ SM1811 ¹⁾ SM1812 ¹⁾ ▼ | | | | | | | | | | | | | |
| 1) <table border="1"> <tr> <td></td> <td>KYB</td> </tr> <tr> <td>1.1, 1.2 (44 kW), 1.4, 1.3 D Multijet</td> <td> SM1810</td> </tr> <tr> <td>1.2 (51 kW), 1.2 4x4, 1.2 LPG, 1.3 D Multijet 4x4, 1.3 JTD Multijet 4x4</td> <td> SM1811</td> </tr> <tr> <td>1.2 Bipower, 1.2 Natural Power, 1.4 Natural Power</td> <td> SM1812▼ SM1810</td> </tr> </table> | | | | | | | | | | | KYB | 1.1, 1.2 (44 kW), 1.4, 1.3 D Multijet | SM1810 | 1.2 (51 kW), 1.2 4x4, 1.2 LPG, 1.3 D Multijet 4x4, 1.3 JTD Multijet 4x4 | SM1811 | 1.2 Bipower, 1.2 Natural Power, 1.4 Natural Power | SM1812▼ SM1810 |
| | KYB | | | | | | | | | | | | | | | | |
| 1.1, 1.2 (44 kW), 1.4, 1.3 D Multijet | SM1810 | | | | | | | | | | | | | | | | |
| 1.2 (51 kW), 1.2 4x4, 1.2 LPG, 1.3 D Multijet 4x4, 1.3 JTD Multijet 4x4 | SM1811 | | | | | | | | | | | | | | | | |
| 1.2 Bipower, 1.2 Natural Power, 1.4 Natural Power | SM1812▼ SM1810 | | | | | | | | | | | | | | | | |
| Panda (312_, 319_) | | | | | | | | | | | | | | | | | |
| (2WD) 0.9, 0.9 Natural Power (59 kW) 1.2, 1.2 LPG 1.3 D Multijet Exc. Trekking | (312_, 319_) | 2.12 - | | 3348053 L 3348052 R | | | 348058 | | | | | | | | | | |
| (2WD) 0.9 (59 kW), 0.9 Natural Power (59 kW) ⊕ Trekking | (312_, 319_) | 12.13 - | | 3348067 L 3348066 R | | | 348058 | | | | | | | | | | |
| 0.9 (4WD) 0.9 Natural Power (63 kW) (2WD) 1.3 D Multijet (70 kW) (2WD) ⊕ Trekking 1.3 D Multijet (4WD) | (312_, 319_) | 6.12 - | | 3348067 L 3348066 R | | | 3430021 | | | | | | | | | | |
| Punto (176) | | | | | | | | | | | | | | | | | |
| 1.1 i 55 1.2 i 60, 75, 85 1.6 i 90 Exc. 1.2 85 Sporting, 1.6 90 Sporting | (176) | 93 - 9.99 | | 333843 324805 | | | 343269 | 554086 244039▼ | | | | | | | | | |
| | | | 910088 | SM1805 | | | | | | | | | | | | | |
| 1.7 Diesel 1.7 Turbo Diesel | (176) | 93 - 9.99 | | 334805 324805 | | | 343269 | 554086 244039▼ | | | | | | | | | |
| | | | 910088 | SM1805 | | | | | | | | | | | | | |
| 1.4 i GT Turbo 1.2 85 Sporting 1.6 90 Sporting | (176) | 93 - 9.99 97 - 9.99 95 - 9.99 | | 334805 324805 | | | | 554086 244039▼ | | | | | | | | | |
| | | | 910088 | SM1805 | | | | | | | | | | | | | |
| Punto (188) | | | | | | | | | | | | | | | | | |
| 1.2, 1.2 16V, 1.2 Bifuel 1.4, 1.3 JTD Exc. 1.2 16V Sporting | (188) | 9.99 - 6.03 - | | 334864 | | | 343329 ¹⁾ 343828 ²⁾ | | | | | | | | | | |
| | | | 910014 | SM1810 | | | | | | | | | | | | | |
| 1) ⊕ Sport sus. 2) ⊕ Normal sus. | | | | | | | | | | | | | | | | | |



Fiat

| MODEL FAHRZEUG MODELE | YEAR JAHR ANNEE | FRONT/VORNE/AVANT | | | | REAR/HINTEN/ARRIERE | | | |
|--|-----------------------|-----------------------------------|-----------------------------|--------------------------------|--|-----------------------------|--|--------------------------------|--|
| | | PREMIUM Twin-tube Oil | EXCEL-G Twin-tube Gas | GAS-A-JUST Mono-tube Gas | | PREMIUM Twin-tube Oil | EXCEL-G Twin-tube Gas | GAS-A-JUST Mono-tube Gas | |
| Fiat (I) | | | | | | | | | |
| Punto (188) | | | | | | | | | |
| 1.9 JTD 1.9 DS | (188) | 9.99 - | | 334865 | | | 343329 ¹⁾ 343828 ²⁾ | | |
| | | | 910014 | SM1811 | | | | | |
| 1.2 16V Sporting 1.8 16V | (188) | 9.99 - | | 334866 | | | 343329 | | |
| | | | 910014 | SM1812▼ SM1810 | | | | | |
| 1) Sport sus. 2) Normal sus. | | | | | | | | | |
| Punto (199) | | | | | | | | | |
| ALL Exc. Abarth | (199) | 3.12 - | | 3348004 L 3348003 R | | | 343459 | | |
| | | | 910112 | SM1820 ¹⁾ | | | 913121 | SM9806 L SM9805 R | |
| 1) Incl. 1.4 Abarth | | | | | | | | | |
| Grande Punto (199) | | | | | | | | | |
| ALL Incl. Sport sus. | (199) | 10.05 - | | 3348004 L 3348003 R | | | 343459 | | |
| | | | 910112 | SM1820 | | | 913121 | SM9806 L SM9805 R | |
| Punto Evo (199) | | | | | | | | | |
| ALL Exc. Abarth | (199) | 7.08 - | | 3348004 L 3348003 R | | | 343459 | | |
| | | | 910112 | SM1820 ¹⁾ | | | 913121 | SM9806 L SM9805 R | |
| 1) Incl. 1.4 Abarth | | | | | | | | | |
| Regata (138) | | | | | | | | | |
| 60, 70, 70 S, 70 ES, 75, 75 S 75 i.e., 75 S i.e. 85, 85 S, 100 S | (138) | 9.83 - 90 85 - 90 9.83 - 90 | 633048▼ | | | 633044 | | | |
| | | | 915812 | | | | | | |
| Diesel Diesel Super, Turbo Diesel | (138) | 9.83 - 90 9.84 - 90 | | | | 633044 | | | |
| | | | 915812 | | | | | | |
| Regata Weekend (138) | | | | | | | | | |
| 70, 70 S, 70 ES, 100 S Exc. Diesel | (138) | 9.84 - 90 | 633048▼ | | | | | | |
| | | | 915812 | | | | | | |
| Ritmo / Strada (138) | | | | | | | | | |
| 60, 65, 75, 85 Diesel | (138) | 78 - 9.82 79 - 9.82 | | | | 633044 | | | |
| | | | 913105 | SM1804 | | | | | |
| Super 75, 85 105 TC | (138) | 81 - 9.82 | | | | 633815 | 333815 | | |
| | | | 913105 | SM1804 | | | | | |
| 125 TC | (138) | 81 - 9.82 | | | | 633815 | 333815 | | |
| | | | | SM1804 | | | | | |



| MODEL FAHRZEUG MODELE | YEAR JAHR ANNEE | FRONT/VORNE/AVANT | | | | REAR/HINTEN/ARRIERE | | | |
|--|-----------------------|---|--|---|--------------|-----------------------------|---|---------------------------------------|--------------|
| | | PREMIUM Twin-tube Oil | EXCEL-G Twin-tube Gas | GAS-A-JUST Mono-tube Gas | | PREMIUM Twin-tube Oil | EXCEL-G Twin-tube Gas | GAS-A-JUST Mono-tube Gas | |
| Fiat (I) | | | | | | | | | |
| Ritmo / Strada (138) | | | | | | | | | |
| 60, 60 ES, Super 60 70, Super 70, 75, Super 75 85, Super 85 (1E No. 4378022-) 75 i.e., 75 S i.e. | (138) | 10.82- 88 10.82- 88 10.82- 88 6.85- 88 | 633048▼ ☞☞☞☞ 915812 | | | 633044 | | | |
| Diesel Turbo Diesel | (138) | 10.82- 88 85- 88 | ☞☞☞☞ 915812 | | | 633044 | | | |
| Sedici | | | | | | | | | |
| (2WD) 1.6 16V, 1.9 JTD, 2.0 JTD | | 6.06- | ☞☞☞☞ 910125 | 333752 L 333751 R ☞☞☞☞ SM5736 | | | 343811 | | |
| (4WD) 1.6 16V, 1.9 JTD, 2.0 D | | 6.06- | ☞☞☞☞ 910125 | 333754 L 333753 R ☞☞☞☞ SM5736 | | | 343812 | | |
| Seicento (187) | | | | | | | | | |
| 0.9, 1.1 Incl. Sporting Exc. Elektra | (187) | 98- 10 | ☞☞☞☞ 915809▼ ☞☞☞☞ 913268 | 333870 ☞☞☞☞ SM1813 ¹⁾ | | 441098 | 341189 | | |
| 1) ⊖ ⊕ | | | | | | | | | |
| Seicento Van (287) | | | | | | | | | |
| 0.9, 1.1 Exc. Elektra | (287) | 98- 10 | ☞☞☞☞ 913268 | 333731 323731 ☞☞☞☞ SM1813 ¹⁾ | | 441098 | 341189 | | |
| 1) ⊖ ⊕ | | | | | | | | | |
| Siena | | | | | | | | | |
| ALL | | 4.96- 01 | ☞☞☞☞ SM1815 L ☞☞☞☞ SM1814 R | 333942 | | | 349052 | | |
| ALL | | 01- 10.07 | | | | | 349052 | | |
| Stilo (192) | | | | | | | | | |
| 1.2 16V 1.4 16V 1.6 16V, 1.8 16V, 1.9 JTD (85 kW) 1.9 JTD (59 kW) 1.9 JTD (66 kW), 1.9 JTD (74 kW) | (192) | 9.01- 11.06 1.04- 11.06 9.01- 11.06 9.01- 11.06 9.04- 11.06 | ☞☞☞☞ 913112 ¹⁾ | 339730 ☞☞☞☞ SM1816 ¹⁾ | | | 343397 ☞☞☞☞ 910013 ¹⁾ | ☞☞☞☞ SM9807 ¹⁾ | |
| 1.9 JTD (93 kW) 1.9 JTD (100 kW) 1.9 JTD (103 kW) 1.9 JTD (110 kW) 2.4 20V | (192) | 1.04- 11.06 1.04- 11.06 1.04- 11.06 1.04- 11.06 9.01- 11.06 | ☞☞☞☞ 913112 ¹⁾ | 339729 ☞☞☞☞ SM1816 ¹⁾ | | | 343397 ☞☞☞☞ 910013 ¹⁾ | ☞☞☞☞ SM9807 ¹⁾ | |
| 1) Incl. 1.9 JTD (88 kW) | | | | | | | | | |



| MODEL FAHRZEUG MODELE | YEAR JAHR ANNEE | FRONT/VORNE/AVANT | | | | REAR/HINTEN/ARRIERE | | | | | | | | | | | | | | | | | | | |
|---|-----------------------|---|-----------------------------|--|--|-----------------------------|-----------------------------|--------------------------------|--|-------------|--------|--------|--------|-------------|--------|-------|--------|-----------------|-------------|---------|--------|-----------------|--------|--|--|
| | | PREMIUM Twin-tube Oil | EXCEL-G Twin-tube Gas | GAS-A-JUST Mono-tube Gas | | PREMIUM Twin-tube Oil | EXCEL-G Twin-tube Gas | GAS-A-JUST Mono-tube Gas | | | | | | | | | | | | | | | | | |
| Fiat (I) | | | | | | | | | | | | | | | | | | | | | | | | | |
| Stilo Multi Wagon (192) | | | | | | | | | | | | | | | | | | | | | | | | | |
| 1.4 16V 1.6 16V, 1.8 16V 1.9 JTD (kW : 59, 74, 85, 88) | (192) | 1.04 - 8.08 1.03 - 8.08 1.03 - 8.08 | | 339730 | | | 344452 | | | | | | | | | | | | | | | | | | |
| | | | 913112 | SM1816 | | | | | | | | | | | | | | | | | | | | | |
| 1.9 JTD (66 kW) 1.9 JTD (kW : 93, 100, 103, 110) | (192) | 9.04 - 8.08 1.04 - 8.08 | | 339729 | | | 344452 ¹⁾ | | | | | | | | | | | | | | | | | | |
| | | | 913112 | SM1816 | | | | | | | | | | | | | | | | | | | | | |
| 1) Exc. 1.9 JTD (66 kW) | | | | | | | | | | | | | | | | | | | | | | | | | |
| Strada | | | | | | | | | | | | | | | | | | | | | | | | | |
| 1.2, 1.7 TD Incl. ABS | (178E) | 6.99 - | | 333942 | | | | | | | | | | | | | | | | | | | | | |
| | | | | SM1815 L ¹⁾ SM1814 R ¹⁾ | | | | | | | | | | | | | | | | | | | | | |
| 1) <table border="1"> <tr> <td>1.2 (44 kW)</td> <td>- 5.06</td> <td>1.7 TD</td> <td>- 3.03</td> </tr> <tr> <td>1.2 (54 kW)</td> <td>- 3.03</td> <td>1.9 D</td> <td>- 1.06</td> </tr> <tr> <td>1.3 JTD (62 kW)</td> <td>6.06 - 6.11</td> <td>1.9 JTD</td> <td>- 5.06</td> </tr> <tr> <td>1.3 JTD (70 kW)</td> <td>5.11 -</td> <td></td> <td></td> </tr> </table> | | | | | | | | | | 1.2 (44 kW) | - 5.06 | 1.7 TD | - 3.03 | 1.2 (54 kW) | - 3.03 | 1.9 D | - 1.06 | 1.3 JTD (62 kW) | 6.06 - 6.11 | 1.9 JTD | - 5.06 | 1.3 JTD (70 kW) | 5.11 - | | |
| 1.2 (44 kW) | - 5.06 | 1.7 TD | - 3.03 | | | | | | | | | | | | | | | | | | | | | | |
| 1.2 (54 kW) | - 3.03 | 1.9 D | - 1.06 | | | | | | | | | | | | | | | | | | | | | | |
| 1.3 JTD (62 kW) | 6.06 - 6.11 | 1.9 JTD | - 5.06 | | | | | | | | | | | | | | | | | | | | | | |
| 1.3 JTD (70 kW) | 5.11 - | | | | | | | | | | | | | | | | | | | | | | | | |
| Tempra (159) | | | | | | | | | | | | | | | | | | | | | | | | | |
| 1.4, 1.6, 1.6 ie | (159) | 90 - 96 | | 333749 324848 | | 444100▼ | 344115 | 554077 | | | | | | | | | | | | | | | | | |
| | | | 915803▼ 910086▼ | SM1802 L▼ SM1803 R▼ | | | | | | | | | | | | | | | | | | | | | |
| 1.8, 1.8 ie, 2.0, 2.0 ie 1.9 Diesel, 1.9 Turbo Diesel | (159) | 90 - 96 | | 334848 324848 | | | 344115 | 554077 | | | | | | | | | | | | | | | | | |
| | | | 916002▼ 910086▼ | SM1802 L▼ SM1803 R▼ | | | | | | | | | | | | | | | | | | | | | |
| Tempra Station Wagon / Familia (159) | | | | | | | | | | | | | | | | | | | | | | | | | |
| 1.4, 1.6, 1.6 ie Exc. | (159) | 90 - 96 | | 333749 324848 | | | 344115 | 554077 | | | | | | | | | | | | | | | | | |
| | | | 915803▼ 910086▼ | SM1802 L▼ SM1803 R▼ | | | | | | | | | | | | | | | | | | | | | |
| 1.8, 2.0 ie, 1.9 Diesel, 1.9 Turbo Diesel Exc. | (159) | 90 - 96 | | 334848 324848 | | | 344115 | 554077 | | | | | | | | | | | | | | | | | |
| | | | 916002▼ 910086▼ | SM1802 L▼ SM1803 R▼ | | | | | | | | | | | | | | | | | | | | | |
| Tipo (160) | | | | | | | | | | | | | | | | | | | | | | | | | |
| 1.1, 1.4, 1.6, 1.6 ie 1.7 D, 1.9 D | (160) | 4.88 - 95 | | 333749 324848 | | 444100▼ | 344115 | 554077 | | | | | | | | | | | | | | | | | |
| | | | 915803▼ 910086▼ | SM1802 L▼ SM1803 R▼ | | | | | | | | | | | | | | | | | | | | | |



| MODEL FAHRZEUG MODELE | YEAR JAHR ANNEE | FRONT/VORNE/AVANT | | | Wrench icon | REAR/HINTEN/ARRIERE | | | Wrench icon |
|---|-----------------------|-----------------------------|--|--------------------------------|-------------|-----------------------------|-----------------------------|--------------------------------|-------------|
| | | PREMIUM Twin-tube Oil | EXCEL-G Twin-tube Gas | GAS-A-JUST Mono-tube Gas | | PREMIUM Twin-tube Oil | EXCEL-G Twin-tube Gas | GAS-A-JUST Mono-tube Gas | |
| Fiat (I) | | | | | | | | | |
| Tipo (160) | | | | | | | | | |
| 1.8, 1.8 ie, 1.8 ie 16V, 1.9 TD 2.0 ie, 2.0 ie 16V | (160) | 1.88 - 95 90 - 95 | | 334848 324848 | | | 344115 | 554077 | |
| | | | 916002 ▼ SM1802 L ▼ 910086 ▼ SM1803 R ▼ | | | | | | |
| Tipo (356) | | | | | | | | | |
| 1.4, 1.4 LPG, 1.6 1.3 D, 1.6 D Exc. | (356) | 3.16 - | | | | | 3458002 | | |
| | | | | | | | SM9806 L SM9805 R | | |
| Tipo (356) | | | | | | | | | |
| | (356) | 10.15 - | | | | | | | |
| | | | | | | | SM9806 L SM9805 R | | |
| Tipo (356) | | | | | | | | | |
| 1.4, 1.4 LPG, 1.6 1.3 D, 1.6 D Incl. | (356) | 3.16 - | | | | | 3458002 | | |
| | | | | | | | SM9806 L SM9805 R | | |
| Ulysse | | | | | | | | | |
| | (220) | 94 - 1.98 | 634927 | 334927 | | 443277 ¹⁾ | 343296 ¹⁾ ▼ | | |
| | | | 910124 MB1907 SM1916 L SM1917 R | | | | | | |
| | (220) | 1.98 - 8.02 | 634927 | 334927 | | 443303 ²⁾ | 343321 ²⁾ | | |
| | | | 910124 MB1907 SM1916 L SM1917 R | | | | | | |
| 2.0 16V, 2.0 JTD, 2.2 JTD, 3.0 V6 (179AX) | (179AX) | 8.02 - 6.11 | | 335934 L 335933 R | | 443303 ²⁾ | 343321 ²⁾ | | |
| | | | 910124 MB1907 SM1916 L SM1917 R | | | | | | |
| 1) L max. = 370mm 2) L max. = 400 mm | | | | | | | | | |
| Uno (146) Exc. CS | | | | | | | | | |
| | (146) | 83 - 95 | 633833 | 333833 | | 443271 | 353010 ▼ | | |
| | | | 915812 SM1800 ▼ | | | | SM9801 ▼ | | |
| X 1/9 (128 AS) | | | | | | | | | |
| 1300 | (128 AS) | 72 - 78 | | 363017 | | | 363017 | | |
| 1500 | (128 AS) | 78 - 82 | | 363017 | | | | | |



| MODEL FAHRZEUG MODELE | YEAR JAHR ANNEE | FRONT/VORNE/AVANT | | | REAR/HINTEN/ARRIERE |
|--|-------------------------|-----------------------------|---|--------------------------------|---------------------|
| | | PREMIUM Twin-tube Oil | EXCEL-G Twin-tube Gas | GAS-A-JUST Mono-tube Gas | |
| Fiat Commercial (I) | | | | | |
| Doblo, Doblo Cargo Exc. | | | | | |
| 1.2, 1.4, 1.6 1.3 JTD 1.9 D, 1.9 DS, 1.9 JTD Exc. | (119, 223) 3.01 - | | 334631 | | 345031 |
| | | 910126 | SM1815 L SM1814 R | | |
| Doblo, Doblo Cargo | | | | | |
| 1.9 DS Fourgon base, Fourgon elegant | (119, 223) 3.01 - | | 334631 | | 345032 |
| | | 910126 | SM1815 L SM1814 R | | |
| Doblo (263) | | | | | |
| Incl. H/D, , Natural Power | (263) 11.09 - | | 339789 L 339788 R | | 349148 |
| | | | SM1822 L SM1821 R | | |
| Doblo Cargo (263) | | | | | |
| Exc. H/D, , Natural Power | (263) 2.10 - | | 339789 L 339788 R | | 349149 |
| | | | SM1822 L SM1821 R | | |
| Incl. H/D, , Natural Power | (263) 2.10 - | | 339789 L 339788 R | | |
| | | | SM1822 L SM1821 R | | |
| Ducato | | | | | |
| 0284193 Exc. | (280) 81 - 4.84 | 635850 | | | 445022 |
| | | | | | |
| 0284194 Exc. | (280) 5.84 - 5.86 | 635851 | | | 445022 |
| | | 910091 | | | |
| | (280) 81 - 4.84 | 635850 | | | 445092 |
| | | | | | |
| Exc. Maxi , | (280, 290) 6.86 - 94 | 635851 | | | 445022 |
| | | 910091 | | | |
| Exc. Maxi | (280, 290) 5.84 - 94 | 635851 | | | 445092 |
| | | 910091 | | | |
| Express 10-13-15 | (280, 290) 6.86 - 94 | 635851 | | | 445022 |
| | | 910091 | | | |
| 10Q Incl. Exc. H/D, Camping Car | (230) 94 - 12.01 | 635806 ²⁾ | | | 344283 |
| | | 910091 | MB1905 SM1920 ⁷⁾ SM1921 ⁷⁾ ¹⁾ | | |

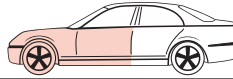

| MODEL FAHRZEUG MODELE | YEAR JAHR ANNEE | FRONT/VORNE/AVANT | | | | REAR/HINTEN/ARRIERE | | | | | | | | | |
|--|-----------------------|-----------------------------|--------------------------------|---|--|-----------------------------|--|--------------------------------|--|---------|---------|----------|----------|----------|----------|
| | | PREMIUM Twin-tube Oil | EXCEL-G Twin-tube Gas | GAS-A-JUST Mono-tube Gas | | PREMIUM Twin-tube Oil | EXCEL-G Twin-tube Gas | GAS-A-JUST Mono-tube Gas | | | | | | | |
| Fiat Commercial (I) | | | | | | | | | | | | | | | |
| Ducato | | | | | | | | | | | | | | | |
| 14Q Incl. Exc. H/D, Camping Car | (230) | 94 - 12.01 | 635806 ²⁾ 910091 | MB1905 SM1920 ⁷⁾ SM1921 ⁷⁾ (SG-704) ¹⁾ | | | 344284 | | | | | | | | |
| 18Q Incl. Exc. H/D, Camping Car | (230) | 94 - 12.01 | 635807 ³⁾ 910096 | MB1905 SM1920 ⁷⁾ SM1921 ⁷⁾ (SG-704) ¹⁾ | | | 345021 | | | | | | | | |
| 18Q Camping Car Grand Export Exc. H/D | (230) | 94 - 12.01 | 635807 ³⁾ 910096 | MB1905 SM1920 ⁷⁾ SM1921 ⁷⁾ (SG-704) ¹⁾ | | | | | | | | | | | |
| Exc. H/D ⊕ Cars built in Russia | (244) | 1.02 - 6.06 | 635806 ²⁾ 910091 | MB1905 SM1926 L ⁸⁾ SM1927 R ⁸⁾ | | | 344283 | | | | | | | | |
| Exc. H/D ⊕ Cars built in Russia | (244) | 1.02 - 6.06 | 635807 ³⁾ 910096 | MB1905 SM1926 L ⁸⁾ SM1927 R ⁸⁾ | | | 345041 | | | | | | | | |
| Incl. H/D, , , Camping Car Exc. | (250) | 4.06 - | 910159 | 335827 ⁴⁾ MB1905 SM1926 L ⁸⁾ SM1927 R ⁸⁾ | | | 345700 ⁵⁾ 345701 ⁶⁾ | | | | | | | | |
| <p>1) 2) 3) 4) </p> <p>5) 345700 : OE p/n = 1355822080, 1362579080, 1357402080, 1362557080, 1355826080, 1362551080, 1356966080, 1362578080</p> <p>6) 345701 : OE p/n = 1355821080, 1362548080, 1356967080, 1362546080, 1355827080, 1362547080, 1355824080, 1362549080, 1368970080, 1355829080, 1362577080, 1368970080</p> <p>7) <table border="1"> <tr> <td> 5616154</td> <td> 5616154</td> </tr> <tr> <td> SM1920 L</td> <td> SM1921 L</td> </tr> <tr> <td> SM1921 R</td> <td> SM1920 R</td> </tr> </table></p> <p>8) → 2.14</p> | | | | | | | | | | 5616154 | 5616154 | SM1920 L | SM1921 L | SM1921 R | SM1920 R |
| 5616154 | 5616154 | | | | | | | | | | | | | | |
| SM1920 L | SM1921 L | | | | | | | | | | | | | | |
| SM1921 R | SM1920 R | | | | | | | | | | | | | | |
| Fiorino Qubo , Fiorino | | | | | | | | | | | | | | | |
| ⊖ ABS | (146) | 93 - | 631601 | | | | 341324 | | | | | | | | |
| ⊕ ABS | (146) | 93 - | 631601 | | | | 341324 | | | | | | | | |



| MODEL FAHRZEUG MODELE | YEAR JAHR ANNEE | FRONT/VORNE/AVANT | | | | REAR/HINTEN/ARRIERE | | | |
|-----------------------------|-----------------------|-----------------------------|-----------------------------|--------------------------------|--|-----------------------------|-----------------------------|--------------------------------|--|
| | | PREMIUM Twin-tube Oil | EXCEL-G Twin-tube Gas | GAS-A-JUST Mono-tube Gas | | PREMIUM Twin-tube Oil | EXCEL-G Twin-tube Gas | GAS-A-JUST Mono-tube Gas | |

Fiat Commercial (I)

Fiorino Qubo , Fiorino

| | | | | | | | | | | |
|---|-------|---------|--------|--|--|--|--|--------|--|--|
| 1.3 D Multijet (55 kW, 70 kW) 1.4 (54 kW), 1.4 Natural Power | (225) | 11.07 - | | 334968 L▼ 334967 R▼ 339809 L 339808 R | | | | 349145 | | |
| | | | 910112 | SM1821 L SM1822 R | | | | | | |
| 1.3 D Multijet (59 kW) | (225) | 3.15 - | | 334968 L▼ 334967 R▼ 339809 L 339808 R | | | | 349145 | | |
| | | | 910112 | SM1821 L SM1822 R | | | | | | |

Scudo (220)

| | | | | | | | | | | |
|---------|-------|--------------|--------|--------------------------------|--|--|----------------------|-----------------------|--|--|
| → 7608 | (220) | 6.94 - 8.97 | 634928 | 334928 | | | 441106 ¹⁾ | 341238 ^{1)▼} | | |
| | | | 910124 | MB1907 SM1916 L SM1917 R | | | | | | |
| 7609 → | (220) | 9.97 - 8.00 | 634928 | 334928 | | | 441107 ²⁾ | 341239 ²⁾ | | |
| | | | 910124 | MB1907 SM1916 L SM1917 R | | | | | | |
| → 09792 | (220) | 9.00 - 12.06 | 634928 | 334928 | | | 441107 ²⁾ | 341239 ²⁾ | | |
| | | | 910124 | MB1907 SM1916 L SM1917 R | | | | | | |

1) L max. = 370mm 2) L max. = 400 mm

Scudo (270)

| | | | | | | | | | | |
|-------------------------|-------|-------------|--------|--------------------------------|--|--|--|--------|--|--|
| Incl. , Exc. H/D | (270) | 1.07 - 2.09 | | 339772 L 339771 R | | | | 345078 | | |
| | | | 910124 | MB1907 SM1916 L SM1917 R | | | | | | |
| , H/D Exc. | (270) | 1.07 - 2.09 | | 339772 L 339771 R | | | | 345079 | | |
| | | | 910124 | MB1907 SM1916 L SM1917 R | | | | | | |
| Incl. H/D, Exc. | (270) | 1.07 - 9.07 | | 339772 L 339771 R | | | | 345079 | | |
| | | | 910124 | MB1907 SM1916 L SM1917 R | | | | | | |



| MODEL FAHRZEUG MODELE | YEAR JAHR ANNEE | FRONT/VORNE/AVANT | | | | REAR/HINTEN/ARRIERE | | | |
|--|---|-----------------------------|--------------------------------|--------------------------------|--|-----------------------------|-----------------------------|--------------------------------|--|
| | | PREMIUM Twin-tube Oil | EXCEL-G Twin-tube Gas | GAS-A-JUST Mono-tube Gas | | PREMIUM Twin-tube Oil | EXCEL-G Twin-tube Gas | GAS-A-JUST Mono-tube Gas | |
| Fiat Commercial (I) | | | | | | | | | |
| Scudo (270) | | | | | | | | | |
| (270) Incl. H/D, | 1.07 - 2.09 | | 339772 L 339771 R | | | | 345079 | | |
| | | 910124 | MB1907 SM1916 L SM1917 R | | | | | | |
| (270) Incl. , H/D, | 2.09 - 3.13 | | 339772 L 339771 R | | | | 3448003 | | |
| | | 910124 | MB1907 SM1916 L SM1917 R | | | | | | |
| Talento | | | | | | | | | |
| (290) Exc. | 88 - 94 | 635851 | | | | | | | |
| | | 910091 | | | | | | | |
| (290) | 88 - 94 | 635851 | | | | 445092 | | | |
| | | 910091 | | | | | | | |
| (296) | 6.16 - | | 335803 | | | | 344803 | | |
| Fiat Polski (PL) | | | | | | | | | |
| 125 P, 126 P, 132 P, Polonez 1500 | | | | | | | | | |
| 126 P | 74 - | 443005 | 343070 ▼ | | | 443006 | | | |
| 132 P | 74 - | 443013 | | | | | | | |
| Polonez 1500 | 79 - 83 | 443013 | | | | 443204 | | | |
| Ford (Europe) | | | | | | | | | |
| B-Max | | | | | | | | | |
| (JK) | 10.12 - | | 3348033 L 3348032 R | | | | 3438002 | | |
| | | | | | | | SM5802 | | |
| Capri | | | | | | | | | |
| Capri I 1.3, 1.6, 2.0, 2.3 Capri II 1.3, 1.6, 2.0, 2.3, 2.6 Capri III 1.6, 2.0, 2.3, 3.0 Exc. 2.8i | 7.72 - 2.74 12.73 - 3.78 4.78 - 12.86 | 665004 | | | | 443022 | | | |
| C-Max | | | | | | | | | |
| 1.6 | 2.07 - | | 334839 L 334838 R | | | | 343413 | | |
| | | 910026 | SM5589 | | | 910099 | SM9203 ▼ | | |
| 1.6 TDCi, 1.8, 1.8 Flexifuel, 1.8 TDCi 2.0, 2.0 CNG, 2.0 LPG, 2.0 TDCi | 2.07 - | | 334841 L 334840 R | | | | 343413 | | |
| | | 910026 | SM5589 | | | 910099 | SM9203 ▼ | | |



| MODEL FAHRZEUG MODELE | YEAR JAHR ANNEE | FRONT/VORNE/AVANT | | | | REAR/HINTEN/ARRIERE | | | |
|---|-----------------------|---------------------------------------|-----------------------------|--------------------------------|--|------------------------------|-----------------------------|--------------------------------|--|
| | | PREMIUM Twin-tube Oil | EXCEL-G Twin-tube Gas | GAS-A-JUST Mono-tube Gas | | PREMIUM Twin-tube Oil | EXCEL-G Twin-tube Gas | GAS-A-JUST Mono-tube Gas | |
| Ford (Europe) | | | | | | | | | |
| C-Max II | | | | | | | | | |
| 1.0 EcoBoost (DXA/CB7, DXA/CEU) 1.6 CNG, 1.6 EcoBoost, 1.6 Flexifuel, 1.6 LPG 1.6 TDCi, 1.6 Ti (kW : 63, 77, 92) 2.0 TDCi (kW : 85, 100, 103, 120) | 4.10 - | | 3348015 L 3348014 R | | | | 349194 | | |
| | | 910245 ¹⁾ SM5589 | | | | 910246 ²⁾ SM9203▼ | | | |
| 1.6 Ti (88 kW) (DXA/CB7, DXA/CEU) | 2.12 - 1.15 | | 3348015 L 3348014 R | | | | 349194 | | |
| | | 910245 ¹⁾ SM5589 | | | | 910246 ²⁾ SM9203▼ | | | |
| 1.5 EcoBoost (DXA/CB7, DXA/CEU) 1.5 TDCi, 1.5 TDCi ECONetic, 1.6 Ti (88 kW) 2.0 TDCi (110 kW, 125 kW) | 1.15 - | | | | | | 349194 | | |
| | | 910245 ¹⁾ SM5589 | | | | 910246 ²⁾ SM9203▼ | | | |
| 2.0 Energi (DXA/CB7, DXA/CEU) | 1.15 - | | | | | | | 554402 | |
| | | 910245 ¹⁾ | | | | 910246 ²⁾ SM9203▼ | | | |
| 1)Phase 1 : 1.10-7.14 Phase 2 : 1.15- | | 2) Exc. C-Max II Van, Grand C-Max Van | | | | | | | |
| Grand C-Max, Grand C-Max Van | | | | | | | | | |
| 1.0 EcoBoost (DXA) 1.6 EcoBoost, 1.6 TDCi, 1.6 Ti 2.0 TDCi (kW : 85, 100, 103, 120) | 12.10 - | | 3348015 L 3348014 R | | | | 349194 | | |
| | | 910245 ¹⁾ SM5589 | | | | 910246 ²⁾ SM9203▼ | | | |
| 1.5 EcoBoost, 1.5 TDCi (DXA) 2.0 TDCi (110 kW, 125 kW) | 3.15 - | | | | | | | | |
| | | 910245 ¹⁾ SM5589 | | | | 910246 ²⁾ SM9203▼ | | | |
| 1)Phase 1 : 1.10-7.14 Phase 2 : 1.15- | | 2) Exc. C-Max II Van, Grand C-Max Van | | | | | | | |
| Consul | | | | | | | | | |
| 1.7, 2.0, 2.3, 2.5, 3.0 | 71 - 9.75 | 443018 | 343003 | | | | 343004 | | |
| Cortina | | | | | | | | | |
| Mk III, Mk IV 1.3, 1.6, 2.0, 2.3 | 71 - 82 | 443016 | | | | 443017 | | | |
| Cougar | | | | | | | | | |
| | (EC) | 8.98 - 2.01 | 335918 | | | | 335919 | | |
| | | | SM1205 | | | SM9201 | | | |
| Ecosport | | | | | | | | | |
| 1.0 EcoBoost, 1.5 Ti, 1.5 TDCi (66 kW, 70 kW) | (KB) | 10.13 - | | | | | | SM5802 | |
| Escort Mk. I, II (68-80) | | | | | | | | | |
| Mk. I 0.9, 1.1, 1.3, GT | (BA) | 8.68 - 9.73 | 663003 | | | 443020 | | | |
| Mk. I 0.9, 1.1, 1.3 Incl. Sport | (BA) | 10.73 - 74 | 663004 | | | 443021 | | | |

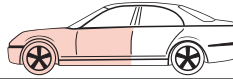

| MODEL FAHRZEUG MODELE | YEAR JAHR ANNEE | FRONT/VORNE/AVANT | | | | REAR/HINTEN/ARRIERE | | | | |
|--|-----------------------|-----------------------------|-----------------------------|--------------------------------|--|-----------------------------|-----------------------------|--------------------------------|--|--|
| | | PREMIUM Twin-tube Oil | EXCEL-G Twin-tube Gas | GAS-A-JUST Mono-tube Gas | | PREMIUM Twin-tube Oil | EXCEL-G Twin-tube Gas | GAS-A-JUST Mono-tube Gas | | |
| Ford (Europe) | | | | | | | | | | |
| Escort Mk. I, II (68-80) | | | | | | | | | | |
| Mk. I 0.9, 1.1, 1.3 | (BA) | 10.73 - 74 | 663004 | | | | 443020 | | | |
| Mk. II 0.9, 1.1, 1.3, 1.6 Incl. Sport | (BA, CA, GA) | 1.75 - 8.80 | 663004 | | | | 443021 | | | |
| Mk. II 0.9, 1.1, 1.3, 1.6 | (BA, CA, GA) | 1.75 - 8.80 | 663004 | | | | | | | |
| Escort Mk. III, IV, XR-3 (80-90) | | | | | | | | | | |
| Mk. III 1.1, 1.3, 1.6 Exc. XR-3 | (GAA, AWA, ABFT) | 9.80 - 4.83 | 633801 | | | | 632801 | 332801▼ | | |
| | | | 915201 | | | | 915204 | | | |
| Mk. III 1.1, 1.3, 1.4, 1.6 1.6 Diesel Exc. XR-3 | (GAA, AWA, ABFT) | 5.83 - 12.84 | 633802 | 333802 | | | 632801 | 332801▼ | | |
| | | | 915201 | SM1203▼ | | | 915204 | | | |
| Mk. III 1.6 Diesel Exc. XR-3 | (GAA, AWA, ABFT) | 1.85 - 12.85 | 633802 | 333802 | | | 632801 | 332801▼ | | |
| | | | 915201 | SM1200 | | | 915204 | | | |
| Mk. III 1.3/1.6 | (GAA, AWA, ABFT) | 5.84 - 12.84 | 633834▼ 633802 | 333802 | | | 632801 | 332801▼ | | |
| | | | 915201 | SM1203▼ | | | 915204 | | | |
| Mk. III 1.3/1.6 | (GAA, AWA, ABFT) | 1.85 - 12.85 | 633834▼ 633802 | 333802 | | | 632801 | 332801▼ | | |
| | | | 915201 | SM1200 | | | 915204 | | | |
| Mk. III XR-3 RS Turbo | (GAA, AWA, ABFT) | 5.83 - 12.84 | | 333802 | | | | 333079 | | |
| | | | 915201 | SM1203▼ | | | 915204 | | | |
| Mk. IV 1.1, 1.3, 1.4, 1.6 Exc. XR-3 | (GAF, AWF, ABFT) | 1.85 - 7.90 | 633802 | 333802 | | | 632801 | 332801▼ | | |
| | | | 915201 | SM1200 | | | 915204 | | | |
| Mk. IV 1.6 Diesel, 1.8 Diesel | (GAF, AWF, ABFT) | 1.86 - 7.90 | 633834▼ 633802 | 333802 | | | 632801 | 332801▼ | | |
| | | | 915201 | SM1200 | | | 915204 | | | |
| Mk. IV XR-3 RS Turbo | (GAF, AWF, ABFT) | 1.85 - 7.90 | | 333802 | | | | 333079 | | |
| | | | 915201 | SM1200 | | | 915204 | | | |
| Mk. IV 1.4, 1.6, XR-3 | (ALF) | 1.86 - 7.90 | | 333802 | | | | 333079 | | |
| | | | 915201 | SM1200 | | | 915204 | | | |



| MODEL FAHRZEUG MODELE | YEAR JAHR ANNEE | FRONT/VORNE/AVANT | | | | REAR/HINTEN/ARRIERE | | | |
|-----------------------------|-----------------------|-----------------------------|-----------------------------|--------------------------------|--|-----------------------------|-----------------------------|--------------------------------|--|
| | | PREMIUM Twin-tube Oil | EXCEL-G Twin-tube Gas | GAS-A-JUST Mono-tube Gas | | PREMIUM Twin-tube Oil | EXCEL-G Twin-tube Gas | GAS-A-JUST Mono-tube Gas | |

Ford (Europe)

Escort Mk. V, VI, XR-3, RS (90-95)

| | | | | | | | | | |
|---|---|--------|--------|--|--|--------------------|--------------------|--------|--|
| Mk. V, VI (GAL) 1.1, 1.3 1.4, 1.4 i Exc. 1.4 iS 1.8 D | 8.90 - 1.95 8.90 - 10.90 8.90 - 11.90 | 633820 | 333820 | | | 441803▼ 441900▼ | 341705▼ 341900▼ | | |
| Mk. V, VI (2WD) (GAL) 1.4, 1.4 i 1.6, 1.6i, 1.8 i 1.8 D, 1.8 TD Exc. 1.4 iS, 1.6 iS, 1.8 iS, XR-3i | 10.90 - 1.95 8.90 - 1.95 11.90 - 1.95 | 633821 | 333821 | | | 441803▼ 441900▼ | 341705▼ 341900▼ | | |
| Mk. V, VI (2WD) (GAL) 1.4 iS, 1.6 iS, 1.8 iS 1.4 i, 1.6 i, 1.8 i Exc. XR-3i | 8.90 - 1.95 | | 333821 | | | | 341705▼ 341900▼ | | |
| Mk. V, VI (4WD) (GAL) 1.8 i RS 2000 16V Exc. Cosworth | 1.92 - 1.95 1.92 - 1.95 | | 333821 | | | | | | |
| Mk. V, VI (2WD) (GAL) XR-3i | 1.92 - 1.95 | | 333821 | | | | 341705▼ 341900▼ | | |
| RS Cosworth (GAL) | 4.92 - 1.95 | | 324015 | | | | | 243034 | |

Escort Mk. VII, XR-3, RS (95- 2.99)

| | | | | | | | | | |
|--|-------------|--|--------|--|--|---------|--------|--|--|
| Mk. VII (GAL, AAL, ABL, AFL) 1.3, 1.4 | 1.95 - 2.99 | | 333826 | | | 441951▼ | 341951 | | |
| Mk. VII (2WD) (GAL, AAL, ABL, AFL) 1.6, 1.8, 1.8 D, 1.8 TD/TDi Exc. Si, XR-3i | 1.95 - 2.99 | | 333826 | | | | 341951 | | |
| Mk. VII (2WD) (GAL, AAL, ABL, AFL) 1.6 Si, 1.8 Si, XR-3i | 1.95 - 2.99 | | 333841 | | | | | | |
| Mk. VII (ALL) 1.6 Si, 1.8 Si, XR-3i | 1.95 - 2.99 | | 333826 | | | | | | |



| MODEL FAHRZEUG MODELE | YEAR JAHR ANNEE | FRONT/VORNE/AVANT | | | | REAR/HINTEN/ARRIERE | | | |
|--|-----------------------|---|-----------------------------|--------------------------------|-----------------------|-----------------------------|-----------------------------|--------------------------------|--|
| | | PREMIUM Twin-tube Oil | EXCEL-G Twin-tube Gas | GAS-A-JUST Mono-tube Gas | | PREMIUM Twin-tube Oil | EXCEL-G Twin-tube Gas | GAS-A-JUST Mono-tube Gas | |
| Ford (Europe) | | | | | | | | | |
| Escort Mk. VII, XR-3, RS (95- 2.99) | | | | | | | | | |
| Mk. VII RS 2000, 1.6 16V Exc. Cosworth | (GAL, AAL, ABL, AFL) | 1.95 - 2.99 | | 333841 | | | | | |
| | | | | | | | | | |
| Escort Turnier / Clipper Mk. V, VI, VII (90-2.99) | | | | | | | | | |
| Mk. V, VI | (GAL, AVL) | 8.90 - 1.95 8.90 - 10.90 8.90 - 11.90 | 633820 | 333820 | | | 343257 | 553181 ▼ | |
| | | | | | | | | | |
| Mk. V, VI | (GAL, AVL) | 10.90 - 1.95 | 633821 | 333821 | | | 343257 | 553181 ▼ | |
| | | | | | | | | | |
| Mk. V, VI | (GAL, AVL) | 10.90 - 1.95 | | 333821 | | | 343257 | 553181 ▼ | |
| | | | | | | | | | |
| Mk. VII 1.3, 1.4, 1.8 TD/TDi | (GAL, ANL) | 1.95 - 8.95 | | 333826 | | | 343257 | 553181 ▼ | |
| | | | | | O.E. = 95 AB-18080-## | | | | |
| Mk. VII 1.3, 1.4, 1.8 TD/TDi | (GAL, ANL) | 8.95 - 2.99 | | 333826 | | | 343276 | 553201 ▼ | |
| | | | | | O.E. = 96 AB-18080-## | | | | |
| Mk. VII | (GAL, ANL) | 1.95 - 8.95 | | 333841 | | | 343257 | 553181 ▼ | |
| | | | | | O.E. = 95 AB-18080-## | | | | |
| Mk. VII | (GAL, ANL) | 8.95 - 2.99 | | 333841 | | | 343276 | 553201 ▼ | |
| | | | | | O.E. = 96 AB-18080-## | | | | |
| Mk. VII | (GAL, ANL) | 2.99 - 7.00 | | 333841 | | | 343276 | 553201 ▼ | |
| | | | | | O.E. = 96 AB-18080-## | | | | |
| Fiesta, XR-2 (-96) | | | | | | | | | |
| Mk. I 1.0, 1.1, 1.3, 1.6 Exc. XR-2 | (GFBT) | 76 - 8.83 | | | | | 332004 | | |
| | | | | | | | | | |
| Mk. I XR-2 | (GFBT) | 81 - 8.83 | | 333044 | | | 332004 | | |
| | | | | | | | | | |
| Mk. II 1.0, 1.1, 1.3, 1.4, 1.6, 1.6 Diesel Exc. XR-2 | (FBD) | 9.83 - 12.84 | 633803 | 333803 | | | 332004 | | |
| | | | | | | | | | |
| Mk. II 1.0, 1.1, 1.3, 1.4, 1.6 Exc. XR-2, Diesel | (FBD) | 1.85 - 89 | 633803 | 333803 | | | 332004 | | |
| | | | | | | | | | |
| Mk. II 1.6 Diesel | (FBD) | 1.85 - 89 | 633803 | 333803 | | | 332004 | | |
| | | | | | | | | | |



| MODEL FAHRZEUG MODELE | YEAR JAHR ANNEE | FRONT/VORNE/AVANT | | | | REAR/HINTEN/ARRIERE | | | |
|--|-----------------------|-----------------------------|-----------------------------|--------------------------------|--|-----------------------------|-----------------------------|--------------------------------|--|
| | | PREMIUM Twin-tube Oil | EXCEL-G Twin-tube Gas | GAS-A-JUST Mono-tube Gas | | PREMIUM Twin-tube Oil | EXCEL-G Twin-tube Gas | GAS-A-JUST Mono-tube Gas | |
| Ford (Europe) | | | | | | | | | |
| Fiesta, XR-2 🚗 (-96) | | | | | | | | | |
| Mk. II XR-2 (FBD) | 9.83 - 12.84 | | | | | | 332004 | | |
| | | 915201 | SM1203▼ | | | | | | |
| Mk. II XR-2 (FBD) | 1.85 - 89 | | 333803 | | | | 332004 | | |
| | | 915201 | SM1200 | | | | | | |
| Mk. III 1.0, 1.1, 1.1 S/iS, 1.3, 1.4, 1.4 S/iS 1.8 D ⊕ Exc. XR-2 (FAJ, FBJ, GFJ) | 1.89 - 12.89 | | 333817 | | | | | | |
| | | 915205▼ | SM1200 | | | | | | |
| | | 910081 | | | | | | | |
| Mk. III XR-2i (FAJ, FBJ, GFJ) | 8.89 - 12.93 | | 333817 | | | | | | |
| | | 910081 | SM1200 | | | | | | |
| Mk. III 1.0, 1.1, 1.3, 1.4, 1.8 D ⊖ Exc. S, iS, XR-2 (FAJ, FBJ, GFJ) | 1.90 - 12.93 | 633818 | 333818▼ | | | | | | |
| | | 915205▼ | SM1200 | | | | | | |
| | | 910081 | | | | | | | |
| Mk. III 1.1 S/iS, 1.4 S/iS, 1.6 ⊕ (FAJ, FBJ, GFJ) | 1.90 - 12.93 | | 333817 | | | | | | |
| | | 915205▼ | SM1200 | | | | | | |
| | | 910081 | | | | | | | |
| Mk. III 1.1, 1.3, 1.4, 1.8 D ⊖ (FAJ, FBJ, GFJ) | 1.94 - 96 | 633822 | 333822 | | | | | | |
| | | | SM1200 | | | | | | |
| Mk. III 1.1, 1.3, 1.4, 1.6 ⊕ (FAJ, FBJ, GFJ) | 1.94 - 96 | | 333823 | | | | | | |
| | | | SM1200 | | | | | | |
| Fiesta IV 🚗 (96-2.02) | | | | | | | | | |
| 1.0, 1.25, 1.3, 1.4, 1.6 ⊖ ⊕ (JA, JB) | 8.95 - 10.98 | | 333701 | | | | 341712 | | |
| | | 910081 | SM1204 | | | | SM9200 | | |
| 1.0, 1.25, 1.3, 1.4, 1.6 ⊖ ⊕ (JA, JB) | 11.98 - 2.02 | | 333701 | | | | 341953 | | |
| | | 910081 | SM1204 | | | | SM9200 | | |
| 1.0, 1.25, 1.3, 1.4, 1.6 ⊕ ⊕ (JA, JB) | 8.95 - 10.98 | | 333702 | | | | 341712 | | |
| | | 910081 | SM1204 | | | | SM9200 | | |
| 1.0, 1.25, 1.3, 1.4, 1.6 ⊕ ⊕ (JA, JB) | 11.98 - 2.02 | | 333702 | | | | 341953 | | |
| | | 910081 | SM1204 | | | | SM9200 | | |
| 1.8 D ⊖ ⊕ (JA, JB) | 8.95 - 10.98 | | 333703 | | | | 341712 | | |
| | | 910081 | SM1204 | | | | SM9200 | | |
| 1.8 D ⊖ ⊕ (JA, JB) | 11.98 - 2.02 | | 333703 | | | | 341953 | | |
| | | 910081 | SM1204 | | | | SM9200 | | |
| 1.8 D ⊕ ⊕ (JA, JB) | 8.95 - 10.98 | | 333704 | | | | 341712 | | |
| | | 910081 | SM1204 | | | | SM9200 | | |
| 1.8 D ⊕ ⊕ (JA, JB) | 11.98 - 2.02 | | 333704 | | | | 341953 | | |
| | | 910081 | SM1204 | | | | SM9200 | | |



| MODEL FAHRZEUG MODELE | YEAR JAHR ANNEE | FRONT/VORNE/AVANT | | | | REAR/HINTEN/ARRIERE | | | | | | | | | | | | | | | | | | | | | | | | | | | |
|--|-----------------------|-----------------------------|-----------------------------|--------------------------------|--|-----------------------------|---|--------------------------------|--|-----------|--|------|----------|-----|----------------------------|---------------|---------|--|--------|--|-------------------|---------------|--------------|----------------|--------|--------|----------------|---|--|--|--|-----------|---|
| | | PREMIUM Twin-tube Oil | EXCEL-G Twin-tube Gas | GAS-A-JUST Mono-tube Gas | | PREMIUM Twin-tube Oil | EXCEL-G Twin-tube Gas | GAS-A-JUST Mono-tube Gas | | | | | | | | | | | | | | | | | | | | | | | | | |
| Ford (Europe) | | | | | | | | | | | | | | | | | | | | | | | | | | | | | | | | | |
| Fiesta V | | | | | | | | | | | | | | | | | | | | | | | | | | | | | | | | | |
| With round spring seat (JH, JD) | 3.02 - 1.04 | | 333401 L 333400 R | | | | | 553308 | | | | | | | | | | | | | | | | | | | | | | | | | |
| | | 910017 | SM1210 | | | 915400 | SM9202 | | | | | | | | | | | | | | | | | | | | | | | | | | |
| With oval spring seat (JH, JD) | 1.04 - 9.08 | | 333384 L 333383 R | | | | | 553308 | | | | | | | | | | | | | | | | | | | | | | | | | |
| | | 910017 | SM1210 | | | 915400 | SM9202 | | | | | | | | | | | | | | | | | | | | | | | | | | |
| Fiesta VI | | | | | | | | | | | | | | | | | | | | | | | | | | | | | | | | | |
| 1.25, 1.4, 1.4 LPG (68 kW) (CB1, CCN) 1.6 Ti (88 kW, 99 kW) 1.4 TDCi, 1.6 TDCi Incl. Sport sus., Comfort sus. | 6.08 - | | 338732 L 338731 R | | | | 3438002 | | | | | | | | | | | | | | | | | | | | | | | | | | |
| | | 910130 ¹⁾²⁾ | SM1550 ³⁾ | | | 915400 ¹⁾ | SM5802 | | | | | | | | | | | | | | | | | | | | | | | | | | |
| 1.0, 1.0 EcoBoost, 1.0 Sport (CB1, CCN) 1.4 LPG (71 kW), 1.6 (62 kW) 1.6 Ti (77 kW) 1.5 TDCi Incl. Sport sus., Comfort sus. | 1.09 - | | 3348042 L 3348041 R | | | | 3438002 | | | | | | | | | | | | | | | | | | | | | | | | | | |
| | | 910130 ¹⁾²⁾ | SM1550 ³⁾ | | | 915400 ¹⁾ | SM5802 | | | | | | | | | | | | | | | | | | | | | | | | | | |
| 1.6 ST, 1.6 ST200 (CB1, CCN) | 3.13 - | | 3348057 L 3348056 R | | | | | | | | | | | | | | | | | | | | | | | | | | | | | | |
| | | | SM1550 ³⁾ | | | | SM5802 | | | | | | | | | | | | | | | | | | | | | | | | | | |
| 1) 7.08 → 11.12 2) Normal sus. 3) <table border="1" style="margin-left: auto; margin-right: auto;"> <thead> <tr> <th colspan="2">Car Model</th> <th>Date</th> <th>Criteria</th> <th>KYB</th> </tr> </thead> <tbody> <tr> <td rowspan="4">Fiesta VI Fiesta VI Van</td> <td rowspan="2">Phase 1 (CB1)</td> <td rowspan="2">- 11.12</td> <td></td> <td>SM1550</td> </tr> <tr> <td></td> <td>SM1214▼ SM1550</td> </tr> <tr> <td rowspan="2">Phase 2 (CCN)</td> <td>11.12 - 3.13</td> <td> exc. ST, ST200</td> <td>SM1550</td> </tr> <tr> <td>3.13 -</td> <td> exc. ST, ST200</td> <td>∅</td> </tr> <tr> <td colspan="2"></td> <td></td> <td>ST, ST200</td> <td>∅</td> </tr> </tbody> </table> | | | | | | | | | | Car Model | | Date | Criteria | KYB | Fiesta VI Fiesta VI Van | Phase 1 (CB1) | - 11.12 | | SM1550 | | SM1214▼ SM1550 | Phase 2 (CCN) | 11.12 - 3.13 | exc. ST, ST200 | SM1550 | 3.13 - | exc. ST, ST200 | ∅ | | | | ST, ST200 | ∅ |
| Car Model | | Date | Criteria | KYB | | | | | | | | | | | | | | | | | | | | | | | | | | | | | |
| Fiesta VI Fiesta VI Van | Phase 1 (CB1) | - 11.12 | | SM1550 | | | | | | | | | | | | | | | | | | | | | | | | | | | | | |
| | | | | SM1214▼ SM1550 | | | | | | | | | | | | | | | | | | | | | | | | | | | | | |
| | Phase 2 (CCN) | 11.12 - 3.13 | exc. ST, ST200 | SM1550 | | | | | | | | | | | | | | | | | | | | | | | | | | | | | |
| | | 3.13 - | exc. ST, ST200 | ∅ | | | | | | | | | | | | | | | | | | | | | | | | | | | | | |
| | | | ST, ST200 | ∅ | | | | | | | | | | | | | | | | | | | | | | | | | | | | | |
| Fiesta | | | | | | | | | | | | | | | | | | | | | | | | | | | | | | | | | |
| 1.6 (62 kW), 1.6 Ti Incl. Sport sus., Comfort sus. | 4.10 - | | 3348042 L 3348041 R | | | | 3438002 | | | | | | | | | | | | | | | | | | | | | | | | | | |
| | | | | | | | SM5802 | | | | | | | | | | | | | | | | | | | | | | | | | | |
| Focus | | | | | | | | | | | | | | | | | | | | | | | | | | | | | | | | | |
| Exc. RS (DAW, DBW, DFW) | 10.98 - 11.04 | | 333710 L 333709 R | | | | 343290 | | | | | | | | | | | | | | | | | | | | | | | | | | |
| | | | 323057 L 323056 R | | | | 353022 | | | | | | | | | | | | | | | | | | | | | | | | | | |
| | | 915208 | SM1209 | | | 910313 | SM5206 ^{1)▼} SM9942 ²⁾ | | | | | | | | | | | | | | | | | | | | | | | | | | |
| 1) Incl. 910313 2) Exc. 910313 | | | | | | | | | | | | | | | | | | | | | | | | | | | | | | | | | |
| Focus | | | | | | | | | | | | | | | | | | | | | | | | | | | | | | | | | |
| (DNW) | 2.99 - 11.04 | | 333710 L 333709 R | | | | 343291 | | | | | | | | | | | | | | | | | | | | | | | | | | |
| | | | 323057 L 323056 R | | | | 353023 | | | | | | | | | | | | | | | | | | | | | | | | | | |
| | | 915208 | SM1209 | | | | | | | | | | | | | | | | | | | | | | | | | | | | | | |

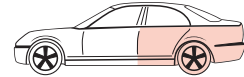
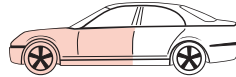

| MODEL FAHRZEUG MODELE | YEAR JAHR ANNEE | FRONT/VORNE/AVANT | | | REAR/HINTEN/ARRIERE | | |
|-----------------------------|-----------------------|-----------------------------|-----------------------------|--------------------------------|-----------------------------|-----------------------------|--------------------------------|
| | | PREMIUM Twin-tube Oil | EXCEL-G Twin-tube Gas | GAS-A-JUST Mono-tube Gas | PREMIUM Twin-tube Oil | EXCEL-G Twin-tube Gas | GAS-A-JUST Mono-tube Gas |

Ford (Europe)

Focus II

| | | | | | | | | | |
|---|------|---------|----------------|----------------------|--|-----------------|--------|--|--|
| 1.4, 1.6, 1.6 LPG 1.6 Ti | (DA) | 11.04 - | | 334839 L 334838 R | | | 343413 | | |
| | | | 910026 SM5589 | | | 910097 SM9203▼ | | | |
| 1.8, 2.0, 2.0 LPG, 2.0 CNG 1.6 TDCi, 1.8 TDCi, 2.0 TDCi Exc. 2.5 ST | (DA) | 11.04 - | | 334841 L 334840 R | | | 343413 | | |
| | | | 910026 SM5589 | | | 910097 SM9203▼ | | | |
| 2.5 RS, 2.5 ST | (DA) | 10.05 - | | | | | | | |
| | | | 910026 SM5589 | | | 910097 SM9203▼ | | | |

Focus II Turnier

| | | | | | | | | | |
|---|-----------|---------|----------------|----------------------|--|--|--|--------|--|
| 1.4, 1.6, 1.6 LPG 1.6 Flexifuel, 1.6 Ti | (DA, DAW) | 11.04 - | | 334839 L 334838 R | | | | 553358 | |
| | | | 910026 SM5589 | | | | | | |
| 1.8, 2.0, ST170 1.6 TDCi, 1.6 LPG 1.8 TDCi, 1.8 Flexifuel, 2.0 TDCi | (DA, DAW) | 11.04 - | | 334841 L 334840 R | | | | 553358 | |
| | | | 910026 SM5589 | | | | | | |

Focus II Cabrio

| | | | | | | | | | |
|-----------------------------------|------|--------------|----------------|----------------------|--|-----------------|--|--|--|
| 1.6, 2.0 TDCi Incl. Sport sus. | (DA) | 10.06 - 7.11 | | 334839 L 334838 R | | | | | |
| | | | 910026 SM5589 | | | 910099 SM9203▼ | | | |
| 2.0 Exc. Sport sus. | (DA) | 10.06 - 7.11 | | 334839 L 334838 R | | | | | |
| | | | 910026 SM5589 | | | 910099 SM9203▼ | | | |

Focus III

| | | | | | | | | | |
|---|--|-------------|---|------------------------|--|-----------------|--------|--|--|
| Incl. Sport sus., H/D, , , , Exc. Electric, RS, ST | | 7.10 - 9.14 | | 3348015 L 3348014 R | | | 349194 | | |
| | | | 910245 ¹⁾ SM5589 ²⁾ | | | 910202 SM9203▼ | | | |
| Incl. Sport sus., , , Exc. Electric, RS, ST | | 9.14 - | | | | | 349194 | | |
| | | | 910245 ¹⁾ SM5589 ²⁾ | | | 910202 SM9203▼ | | | |
| 2.0 ST | | 7.12 - 9.14 | | 3348015 L 3348014 R | | | | | |
| | | | SM5589 ²⁾ | | | SM9203▼ | | | |

1) Exc. Sport sus., H/D,

2)

| Sus. | | Date | | Exc. |
|--------|--|-----------------------|-------|---------|
| Normal | 1.0 EcoBoost, 1.5 EcoBoost, 1.5 TDCi, 1.5 TDCi ECONetic, 1.6 Flexifuel, 1.6 LPG, 1.6 TDCi (70 kW), 1.6 TDCi ECONetic, 1.6 Ti, 2.0 TDCi (110 kW), 2.0 Ti-GDi | 7.10 → 2.15 | - | H/D |
| | 1.6 EcoBoost, 1.6 TDCi (77 kW, 85 kW), 2.0 TDCi (kW : 85, 100, 103, 120, 136) | 7.10 → | - | |
| Sport | 1.0 EcoBoost, 1.5 TDCi (70 kW), 1.5 TDCi ECONetic, 1.6 EcoBoost, 1.6 Flexifuel, 1.6 LPG, 1.6 TDCi, 1.6 TDCi ECONetic, 1.6 Ti (63 kW, 88 kW), 2.0 TDCi (kW : 85, 100, 103, 120, 136), 2.0 Ti-GDi | 7.10 → | - | |
| | 1.5 EcoBoost, 1.5 TDCi (88 kW), 1.6 Ti (77 kW, 92 kW), 2.0 TDCi (110 kW) | 7.10 → 2.15 3.15 → | - | |



| MODEL FAHRZEUG MODELE | YEAR JAHR ANNEE | FRONT/VORNE/AVANT | | | | REAR/HINTEN/ARRIERE | | | |
|-----------------------------|-----------------------|-----------------------------|-----------------------------|--------------------------------|--|-----------------------------|-----------------------------|--------------------------------|--|
| | | PREMIUM Twin-tube Oil | EXCEL-G Twin-tube Gas | GAS-A-JUST Mono-tube Gas | | PREMIUM Twin-tube Oil | EXCEL-G Twin-tube Gas | GAS-A-JUST Mono-tube Gas | |

Ford (Europe)

Focus III

| | | | | | | | | | |
|----------|--------------|--|------------------------|--|--|--|---------|--|--|
| Electric | 7.13 - 10.14 | | 3348015 L 3348014 R | | | | 349194 | | |
| | | | SM5589 ¹⁾ | | | | SM9203▼ | | |
| Electric | 11.14 - | | | | | | 349194 | | |
| | | | SM5589 ¹⁾ | | | | SM9203▼ | | |

1)

| Sus. | | Date | ⊕ | Exc. |
|--------|---|-----------------------|-------|---------|
| Normal | 1.0 EcoBoost, 1.5 EcoBoost, 1.5 TDCi, 1.5 TDCi ECONetic, 1.6 Flexifuel, 1.6 LPG, 1.6 TDCi (70 kW), 1.6 TDCi ECONetic, 1.6 Ti, 2.0 TDCi (110 kW), 2.0 Ti-GDi | 7.10 → 2.15 | - | H/D |
| | 1.6 EcoBoost, 1.6 TDCi (77 kW, 85 kW), 2.0 TDCi (kW : 85, 100, 103, 120, 136) | 7.10 → | - | |
| Sport | 1.0 EcoBoost, 1.5 TDCi (70 kW), 1.5 TDCi ECONetic, 1.6 EcoBoost, 1.6 Flexifuel, 1.6 LPG, 1.6 TDCi, 1.6 TDCi ECONetic, 1.6 Ti (63 kW, 88 kW), 2.0 TDCi (kW : 85, 100, 103, 120, 136), 2.0 Ti-GDi | 7.10 → | - | |
| | 1.5 EcoBoost, 1.5 TDCi (88 kW), 1.6 Ti (77 kW, 92 kW), 2.0 TDCi (110 kW) | 7.10 → 2.15 3.15 → | - | |

Focus III Turnier

| | | | | | | | | | |
|--|---|--|------------------------|--|--|--|--|--------|--|
| 1.0 EcoBoost, 1.6 Flexifuel 1.6 LPG, 1.6 TDCi (70 kW) 1.6 TDCi ECONetic, 1.6 Ti 1.6 EcoBoost, 1.6 TDCi (85 kW) 2.0 TDCi (kW : 85, 100, 103, 120) Incl. , Exc. Sport sus., H/D | 7.10 - 9.14 7.10 - 9.14 7.10 - 9.14 7.10 - 7.10 - | | 3348015 L 3348014 R | | | | | 553358 | |
| | | | SM5589 ¹⁾ | | | | | | |
| 1.0 EcoBoost, 1.6 Flexifuel 1.6 LPG, 1.6 TDCi (70 kW) 1.6 TDCi ECONetic, 1.6 Ti 1.5 EcoBoost, 1.5 TDCi 1.5 TDCi ECONetic 2.0 TDCi (110 kW, 136 kW) Incl. , Exc. Sport sus., H/D | 10.14 - 10.14 - 10.14 - 9.14 - 9.14 - 9.14 - | | | | | | | 553358 | |
| | | | SM5589 ¹⁾ | | | | | | |
| 1.0 EcoBoost, 1.6 Flexifuel 1.6 LPG, 1.6 TDCi (70 kW) 1.6 TDCi ECONetic, 1.6 Ti 1.6 EcoBoost, 1.6 TDCi (85 kW) 2.0 TDCi (kW : 85, 100, 103, 120) ⊕ Sport sus., H/D Incl. , | 7.10 - 9.14 7.10 - 9.14 7.10 - 9.14 7.10 - 7.10 - | | 3348015 L 3348014 R | | | | | | |
| | | | SM5589 ¹⁾ | | | | | | |
| 2.0 ST | 7.12 - 9.14 | | 3348015 L 3348014 R | | | | | | |
| | | | SM5589 ¹⁾ | | | | | | |
| 1.5 EcoBoost, 1.5 TDCi 1.5 TDCi ECONetic 2.0 TDCi (110 kW, 136 kW) Incl. Sport sus. | 9.14 - | | | | | | | | |
| | | | SM5589 ¹⁾ | | | | | | |

1) Exc. H/D,
→ 2.15



Ford

| MODEL FAHRZEUG MODELE | YEAR JAHR ANNEE | FRONT/VORNE/AVANT | | | | REAR/HINTEN/ARRIERE | | | |
|---|-----------------------|-----------------------------|-----------------------------|--------------------------------|--|-----------------------------|-----------------------------|--------------------------------|--|
| | | PREMIUM Twin-tube Oil | EXCEL-G Twin-tube Gas | GAS-A-JUST Mono-tube Gas | | PREMIUM Twin-tube Oil | EXCEL-G Twin-tube Gas | GAS-A-JUST Mono-tube Gas | |
| Ford (Europe) | | | | | | | | | |
| Focus C-Max | | | | | | | | | |
| 1.6 i 16V | 10.03 - 3.07 | | 334839 L 334838 R | | | | 343413 | | |
| | | 910026 | SM5589 | | | 910099 | SM9203 ▼ | | |
| 1.6 TDCi, 1.6 TDCi 16V 1.8 TDCi, 2.0 TDCi 16V 1.8 16V, 2.0 | 10.03 - 3.07 | | 334841 L 334840 R | | | | 343413 | | |
| | | 910026 | SM5589 | | | 910099 | SM9203 ▼ | | |
| Fusion | | | | | | | | | |
| with round spring (JU) | 8.02 - 1.04 | | 333399 L 333398 R | | | | | 553309 | |
| | | 910127 | SM1210 | | | 915400 | SM9202 | | |
| with oval spring (JU) | 1.04 - | | 333380 L 333379 R | | | | | 553309 | |
| | | 910127 | SM1210 | | | 915400 | SM9202 | | |
| Galaxy | | | | | | | | | |
| (WGR) Exc. | 5.95 - 4.06 | | 334947 | | | | 343319 | 553244 | |
| | | 910090 | SM1704 | | | | | | |
| 1.6, 1.6 EcoBoost, 1.6 TDCi 1.8 TDCi, 2.0, 2.0 Bio petrol 2.0 EcoBoost (149 kW) 2.0 TDCi, 2.2 TDCi, 2.3 Incl. Sport sus., ESP (WA6) | 4.06 - | | 339721 L 339720 R | | | | 349021 | | |
| | | 910128 | SM1014 | | | 935311 | SM9909 | | |
| Granada | | | | | | | | | |
| 1.6, 1.7, 2.0, (GGTL, GGFL, GGNL) 2.3, 2.6, 3.0 | 71 - 8.77 | 443018 | 343003 | | | | 343004 | | |
| | | | | | | | | | |
| 1.6, 1.7, 2.0, 2.3, 2.6, 2.8 (GU, GNU) 1.9 D, 2.1 D, 2.5 D | 9.77 - 4.85 | | 343003 | | | | 343004 | | |
| | | | | | | | | | |
| Ka, Sport Ka, Street Ka | | | | | | | | | |
| 1.0 i, 1.3 i (RB) | 9.96 - 10.98 | | 333700 | | | | 341712 | | |
| | | 910138 ▼ 910081 | SM1204 | | | | SM9200 | | |
| 1.0 i, 1.3 i (RB) | 10.98 - 3.00 | | 333700 | | | | 341953 | | |
| | | 910138 ▼ 910081 | SM1204 | | | | SM9200 | | |
| 1.0 i, 1.3 i (RB) | 4.00 - 4.03 | | 333700 | | | | 341817 | | |
| | | 910138 ▼ 910081 | SM1204 | | | | SM9200 | | |
| 1.6 i Sport Ka (RB) | 2.01 - 4.03 | | 333700 | | | | 341817 | | |
| | | 910282 | SM1204 | | | | SM9200 | | |



| MODEL FAHRZEUG MODELE | YEAR JAHR ANNEE | FRONT/VORNE/AVANT | | | | REAR/HINTEN/ARRIERE | | | |
|---|-----------------------|-----------------------------|--|--------------------------------|--|-----------------------------|-----------------------------|--------------------------------|--|
| | | PREMIUM Twin-tube Oil | EXCEL-G Twin-tube Gas | GAS-A-JUST Mono-tube Gas | | PREMIUM Twin-tube Oil | EXCEL-G Twin-tube Gas | GAS-A-JUST Mono-tube Gas | |
| Ford (Europe) | | | | | | | | | |
| Ka, Sport Ka, Street Ka | | | | | | | | | |
| 1.3 i (RB) | 4.03 - 11.08 | | 333760 L 333759 R | | | | 341817 | | |
| | | 910138 ▼ SM1204 910081 | | | | | SM9200 | | |
| 1.6 i (RB) | 7.03 - 11.08 | | 333760 L 333759 R | | | | | | |
| | | 910138 ▼ SM1204 910081 | | | | | SM9200 | | |
| 1.6 i Sport Ka (RB, RL2) 1.6 i Street Ka | 4.03 - 11.08 | | 333762 L 333761 R | | | | 341817 | | |
| | | 910282 SM1204 | | | | | SM9200 | | |
| Ka II 1.2, 1.3 TDCi (RU8) | 10.08 - | | 333775 L 333774 R | | | | 343486 | | |
| | | 910014 SM1213 ▼ SM1811 | | | | | | | |
| Kuga I | | | | | | | | | |
| | 3.08 - | | 335613 L ▼ 335612 R ▼ 339736 L 339735 R | | | | 349106 | | |
| | | 910262 SM5589 | | | | 910099 SM9203 ▼ | | | |
| Kuga II | | | | | | | | | |
| | (DM2) 10.12 - 9.14 | | 3348048 L 3348047 R | | | | 349106 | | |
| | | 910263 | | | | 910264 SM9203 ▼ | | | |
| | (DM2) 10.14 - | | | | | | 349106 | | |
| | | 910263 | | | | 910264 SM9203 ▼ | | | |
| Maverick | | | | | | | | | |
| | (R20) 93 - 4.96 | 444102 | 344200 | 554070 ▼ | | 443295 | 343355 | 553230 | |
| | (UDS/UNS) 9.96 - 4.98 | 444102 | 344200 | 554070 ▼ | | 443295 | 343355 | 553230 | |
| | (1EZ) 12.00 - | | 334334 L 334333 R | | | | 344356 | | |
| Mondeo Exc. | | | | | | | | | |
| 1.6, 1.8, 2.0, 2.5, 1.8 TD Exc. Sport sus. | 1.93 - 9.94 | | 334822 | | | | 334823 | | |
| | | 915200 ▼ SM1205 | | | | 915203 ▼ SM9201 | | | |
| 2.0, 2.5 ⊕ Sport sus. | 6.93 - 9.94 | | 334822 | | | | 334823 | | |
| | | 915200 ▼ SM1205 | | | | 915203 ▼ SM9201 | | | |



| MODEL FAHRZEUG MODELE | YEAR JAHR ANNEE | FRONT/VORNE/AVANT | | | REAR/HINTEN/ARRIERE | | |
|-----------------------------|-----------------------|-----------------------------|-----------------------------|--------------------------------|-----------------------------|-----------------------------|--------------------------------|
| | | PREMIUM Twin-tube Oil | EXCEL-G Twin-tube Gas | GAS-A-JUST Mono-tube Gas | PREMIUM Twin-tube Oil | EXCEL-G Twin-tube Gas | GAS-A-JUST Mono-tube Gas |

Ford (Europe)

Mondeo Exc.

| | | | | | | | | | |
|--|--------------|--|----------------------|---|--|--|------------------|------------------------|--|
| (2WD) 1.6, 1.8, 2.0, 2.5, 1.8 TD Incl. Sport sus. | 10.94 - 7.96 | | 334822 | 915200 SM1205 | | | 334823 | 915203 SM9201 | |
| (4WD) 1.8, 2.0, 1.8 TD | 1.93 - 7.96 | | 334822 | 915200 SM1205 | | | 915203 | | |
| Mondeo II (BAP, BFP) (2WD) 1.6, 1.8, 2.0, 2.5, 1.8 TD Exc. Sport sus. | 8.96 - 11.00 | | 334824 | 915200 SM1205 | | | 334825 | 915203 SM9201 | |
| Mondeo III (B4Y, B5Y) ALL Exc. H/D, Sport sus., ST 220 | 11.00 - 8.07 | | 339758 | 910104 SM1211 | | | 335923 339759 | 910016 SM9204 | |
| Mondeo III (B5Y) ALL ⊕ H/D Exc. Sport sus., ST 220 | 11.00 - 8.07 | | 339758 | 910104 SM1211 | | | 335923 339759 | 910016 SM9204 | |
| Mondeo IV (BA7) 1.6 Ti, 1.6 EcoBoost, 1.6 TDCi 1.8 TDCi, 2.0, 2.0 SCTi, 2.0 TDCi 2.0 LPG, 2.0 Flexifuel, 2.0 EcoBoost 2.2 TDCi, 2.3, 2.5 Incl. Sport sus. | 3.07 - | | 339719 L 339718 R | 910170 ¹⁾ SM1014 910171 ²⁾ | | | 349021 | Exc. 935310 SM9909 | |

1) Exc. Sport sus. 2) ⊕ Sport sus.

Mondeo Turnier

| | | | | | | | | | |
|--|--------------|--|----------------------|---|--|--|--------|----------------|--|
| (2WD) (4WD) 1.6, 1.8, 2.0, 2.5, 1.8 TD | 1.93 - 7.96 | | 334822 | 915200 SM1205 | | | | 554078 Exc. | |
| Mondeo II Turnier (BNP) (2WD) 1.6, 1.8, 1.8 TD, 2.0, 2.5, 2.5 ST 200 Exc. Sport sus. | 8.96 - 11.00 | | 334824 | 915200 SM1205 | | | | 553217 Exc. | |
| Mondeo III Turnier (BWY) ALL Exc. H/D, Sport sus., , ST 220 | 11.00 - 8.07 | | 339758 | 910104 SM1211 | | | | 553217 Exc. | |
| Mondeo IV Turnier (BA7) 1.6 Ti, 1.6 EcoBoost, 1.6 TDCi 1.8 TDCi, 2.0, 2.0 SCTi, 2.0 TDCi 2.0 LPG, 2.0 Flexifuel, 2.0 EcoBoost 2.2 TDCi, 2.3, 2.5 Incl. Sport sus. Exc. , | 3.07 - | | 339719 L 339718 R | 910170 ¹⁾ SM1014 910171 ²⁾ | | | 349021 | 935311 SM9909 | |

1) Exc. Sport sus. 2) ⊕ Sport sus.



| MODEL FAHRZEUG MODELE | YEAR JAHR ANNEE | FRONT/VORNE/AVANT | | | | REAR/HINTEN/ARRIERE | | | |
|---|--|-----------------------------|-----------------------------|--------------------------------|--|-----------------------------|-----------------------------|--------------------------------|--|
| | | PREMIUM Twin-tube Oil | EXCEL-G Twin-tube Gas | GAS-A-JUST Mono-tube Gas | | PREMIUM Twin-tube Oil | EXCEL-G Twin-tube Gas | GAS-A-JUST Mono-tube Gas | |
| Ford (Europe) | | | | | | | | | |
| Mondeo V | | | | | | | | | |
| (CE, CD, CF) ⊕ Sport sus. Exc. | 9.12 - | | | | | | 3440125 | | |
| Orion | | | | | | | | | |
| 1.3, 1.4, 1.6, 1.6 Diesel Exc. 1.6 i | 5.83 - 12.84 | 633802 | 333802 | | | 632801 | 332801▼ | | |
| | | 915201 | SM1203▼ | | | 915204 | | | |
| 1.6 i | 5.83 - 12.84 | | 333802 | | | | 333079 | | |
| | | 915201 | SM1203▼ | | | | | | |
| 1.3, 1.4, 1.6 Exc. 1.6 i | 1.85 - 7.90 | 633802 | 333802 | | | 632801 | 332801▼ | | |
| | | 915201 | SM1200 | | | 915204 | | | |
| 1.6 Diesel | 1.85 - 12.85 | 633802 | 333802 | | | 632801 | 332801▼ | | |
| | | 915201 | SM1200 | | | 915204 | | | |
| 1.6 Diesel, 1.8 Diesel Exc. Ghia (Portugal) | 1.86 - 7.90 | 633834▼ 633802 | 333802 | | | 632801 | 332801▼ | | |
| | | 915201 | SM1200 | | | 915204 | | | |
| 1.6 i | 1.85 - 7.90 | | 333802 | | | | 333079 | | |
| | | 915201 | SM1200 | | | | | | |
| 1.6 Diesel Ghia (Portugal) | 1.86 - 7.90 | | 333802 | | | | 333079 | | |
| | | 915201 | SM1200 | | | | | | |
| 1.1, 1.3 1.4, 1.4 i, 1.8 Diesel Exc. S, Ghia | 8.90 - 1.95 8.90 - 10.90 | 633820 | 333820 | | | 441803▼ 441900▼ | 341705▼ 341900▼ | | |
| | | 910081 | SM1202 | | | | | | |
| 1.4, 1.4 i, 1.8 Diesel 1.6, 1.6 i, 1.8 i, 1.8 TD Exc. S, Ghia | 11.90 - 1.95 8.90 - 10.90 | 633821 | 333821 | | | 441803▼ 441900▼ | 341705▼ 341900▼ | | |
| | | 910081 | SM1202 | | | | | | |
| 1.4 iS, 1.6 iS, 1.8 iS Ghia | 8.90 - 1.95 | | 333821 | | | | 341705▼ 341900▼ | | |
| | | 910081 | SM1202 | | | | | | |
| Puma | | | | | | | | | |
| 1.4 i 16V 1.7 i 16V | 11.97 - 9.98 3.97 - 12.98 | | 333943 | | | | 341916 | | |
| | | | SM1204 | | | | SM9200 | | |
| 1.4 i 16V 1.6 i 16V 1.7 i 16V ST 160 | 10.98 - 10.00 9.00 - 12.98 - 6.99 - | | 333943 | | | | | | |
| | | | SM1204 | | | | SM9200 | | |
| Scorpio | | | | | | | | | |
| 2.0, 2.3, 2.9 V6, 2.5 TD Incl. 16V, 24V | (GFR) 10.94 - 8.98 | | | | | | 343205 | | |
| | | | | | | | Exc. | | |



| MODEL FAHRZEUG MODELE | YEAR JAHR ANNEE | FRONT/VORNE/AVANT | | | | REAR/HINTEN/ARRIERE | | | |
|---|-----------------------|-----------------------------|-----------------------------|--------------------------------|--|-----------------------------|-----------------------------|--------------------------------|--|
| | | PREMIUM Twin-tube Oil | EXCEL-G Twin-tube Gas | GAS-A-JUST Mono-tube Gas | | PREMIUM Twin-tube Oil | EXCEL-G Twin-tube Gas | GAS-A-JUST Mono-tube Gas | |
| Ford (Europe) | | | | | | | | | |
| Scorpio/ Granada (GAE/GGE) | | | | | | | | | |
| (2WD) 1.8, 2.0, 2.0 i, 2.4 i, 2.8 i, 2.9 i 2.5 D, 2.5 TD Exc. (4WD), 2.9 i 24V | (GAE) | 5.85 - 1.92 | 634015 | 334018 | | | 343205 | | |
| | | | 915209▼ SM1207▼ 910090 | | | | Exc. | | |
| (2WD) 2.0, 2.4, 2.9, 2.9 24V, 2.5 TD | (GAE) | 2.92 - 9.94 | | 334018 | | | 343205 | | |
| | | | 915209▼ SM1207▼ 910090 | | | | Exc. | | |
| (2WD) 2.0, 2.4, 2.9, 2.9 24V, 2.5 TD | (GGE) | 2.92 - 9.94 | | 334018 | | | | | |
| | | | 915209▼ SM1207▼ 910090 | | | | | | |
| Sierra, XR-4, Cosworth | | | | | | | | | |
| 1.3, 1.6, 2.0, 2.3, 2.3 D | | 12.82 - 5.84 | 633038▼ | | | 441048 | 341044 | | |
| | | | 915210▼ SM1203▼ | | | | | | |
| XR-4 i | | 12.82 - 5.84 | | | | | 341044 | | |
| | | | 915210▼ SM1203▼ | | | | | | |
| (2WD) 1.3, 1.6, 1.8, 2.0, 2.3, 1.8 D | | 6.84 - 93 | 633832 | 333832 | | 441048 | 341044 | | |
| | | | 915210▼ SM1200 | | | | | | |
| (2WD) 2.3 D | | 6.84 - 93 | 633832 | 333832 | | 441048 | 341044 | | |
| | | | 915210▼ SM1200 | | | | | | |
| (2WD) XR-4 i Exc. Cosworth 2.8 i, 2.9 i | | 6.84 - 93 | | 333832 | | | 341044 | | |
| | | | 915210▼ SM1200 | | | | | | |
| (2WD) Cosworth | | 86 - 90 | | | | | | 553226 | |
| | | | 915210▼ SM1200 | | | | | 243034 | |
| Sierra | | | | | | | | | |
| (4WD) Exc. Cosworth | | 85 - 93 | | 334219 | | | | 553226 | |
| | | | 915210▼ SM1200 | | | | | 243034 | |
| | | | | 324015 | | | | | |
| (4WD) Cosworth | | 90 - 93 | | 334219 | | | | 553226 | |
| | | | 915210▼ SM1200 | | | | | 243034 | |
| | | | | 324015 | | | | | |
| Sierra | | | | | | | | | |
| (2WD) 1.3, 1.6, 1.8, 2.0, 2.3, 2.3 D, 2.9 | | 12.82 - 5.84 | 633038▼ | | | 443208 | 343187▼ | | |
| | | | 915210▼ | | | | Exc. | | |
| (2WD) 1.3, 1.6, 1.8, 2.0, 2.3, 2.9 | | 6.84 - 93 | 633832 | 333832 | | 443208 | 343187▼ | | |
| | | | 915210▼ SM1200 | | | | Exc. | | |
| (2WD) 2.3 D | | 6.84 - 93 | 633832 | 333832 | | 443208 | 343187▼ | | |
| | | | 915210▼ SM1200 | | | | Exc. | | |



| MODEL FAHRZEUG MODELE | YEAR JAHR ANNEE | FRONT/VORNE/AVANT | | | | REAR/HINTEN/ARRIERE | | | |
|--|---------------------------------|-----------------------------|-----------------------------|--------------------------------|---------|-----------------------------|-----------------------------|--------------------------------|--|
| | | PREMIUM Twin-tube Oil | EXCEL-G Twin-tube Gas | GAS-A-JUST Mono-tube Gas | | PREMIUM Twin-tube Oil | EXCEL-G Twin-tube Gas | GAS-A-JUST Mono-tube Gas | |
| Ford (Europe) | | | | | | | | | |
| Sierra | | | | | | | | | |
| | 85 - 93 | | 334219 | | | 443208 | 343187▼ | | |
| | | | 915210▼ | | SM1200 | | Exc. | | |
| S-Max | | | | | | | | | |
| 1.6 EcoBoost, 1.6 TDCi, 1.8 TDCi, (WA6) 2.0, 2.0 Bio-petrol, 2.0 EcoBoost, 2.0 TDCi, 2.2 TDCi, 2.3, 2.5 Incl. Sport sus Exc. | 3.06 - | | 339721 L 339720 R | | | | 349021 | | |
| | | | 910128 | | SM1014 | | | SM9909 | |
| Taurus | | | | | | | | | |
| 17 M, 20 M (P5) 17 M, 20 M (P7) 26M | 8.64 - 66 67 - 70 69 - 70 | 665002 | | | | 443015 | | | |
| | | | | | | | | | |
| 1.3, 1.6, 2.0, 2.3 | 70 - 11.82 | 443016 | | | | 443017 | | | |
| | | | | | | | | | |
| Ford Commercial (Europe) | | | | | | | | | |
| Escort Van, Express | | | | | | | | | |
| 20, 40, 50 | 1.75 - 7.80 | 663004 | | | | | | | |
| | | | | | | | 343228 | | |
| 35, 55 Exc. | 80 - 5.83 | | | | | | 343228 | | |
| | | | 915201 | | | | 343228 | | |
| 35, 55 Exc. | 6.83 - 7.90 | | | | | | 343228 | | |
| | | | 915201 | | | | 343228 | | |
| | 8.90 - 95 | 633820 | 333820 | | | 443278 | | | |
| | | | 910081 | | SM1202 | | | | |
| Escort Van, Express | | | | | | | | | |
| | 8.90 - 95 | 633821 | 333821 | | | 443278 | | | |
| | | | 910081 | | SM1202 | | | | |
| | 1.95 - | | 333826 | | | 443278 | | | |
| | | | | | | | | | |
| | | | | | | | | | |
| Fiesta Van, Courier | | | | | | | | | |
| Van 7 cwt 1.3 | 76 - 8.83 | | | | | | 332004 | | |
| | | | 915201 | | | | 332004 | | |
| Van 7 cwt 1.3, 1.6, Diesel | 9.83 - 12.84 | 633803 | 333803 | | | | 332004 | | |
| | | | 915201 | | SM1203▼ | | 332004 | | |
| Van 7 cwt 1.3 | 1.85 - 89 | 633803 | 333803 | | | | 332004 | | |
| | | | 915201 | | SM1200 | | 332004 | | |
| Van 7 cwt 1.6, Diesel | 1.85 - 89 | 633803 | 333803 | | | | 332004 | | |
| | | | 915201 | | SM1200 | | 332004 | | |



Ford

| MODEL FAHRZEUG MODELE | YEAR JAHR ANNEE | FRONT/VORNE/AVANT | | | | REAR/HINTEN/ARRIERE | | | |
|------------------------------------|-----------------------|-----------------------------|-----------------------------|--------------------------------|--|-----------------------------|-----------------------------|--------------------------------|--|
| | | PREMIUM Twin-tube Oil | EXCEL-G Twin-tube Gas | GAS-A-JUST Mono-tube Gas | | PREMIUM Twin-tube Oil | EXCEL-G Twin-tube Gas | GAS-A-JUST Mono-tube Gas | |
| Ford Commercial (Europe) | | | | | | | | | |
| Fiesta Van, Courier | | | | | | | | | |
| Van (FVJ) Exc. Diesel, Courier | 89 - 12.93 | 633818 | 333818▼ | | | | | | |
| | | 915205▼ SM1200 | | | | | | | |
| | | 910081 | | | | | | | |
| Van Diesel (FVJ) Exc. Courier | 89 - 12.93 | 633818 | 333818▼ | | | | | | |
| | | 915205▼ SM1200 | | | | | | | |
| | | 910081 | | | | | | | |
| Courier 1.3 (F3, F5) | 89 - 12.93 | | 333817 | | | | 343273 | | |
| | | 915205▼ SM1200 | | | | | | | |
| | | 910081 | | | | | | | |
| Courier 1.8 Diesel (F3, F5) | 89 - 12.93 | | 333817 | | | | 343273 | | |
| | | 915205▼ SM1200 | | | | | | | |
| | | 910081 | | | | | | | |
| Courier 1.3 (F3, F5) | 94 - 96 | | 333823 | | | | 343273 | | |
| | | | SM1200 | | | | | | |
| Courier 1.8 Diesel (F3, F5) | 94 - 96 | | 333823 | | | | 343273 | | |
| | | | SM1200 | | | | | | |
| 1.0, 1.25, 1.3, 1.4 (JV) | 8.95 - 10.98 | | 333701 | | | | 341712 | | |
| | | 910081 SM1204 | | | | | | | |
| 1.0, 1.25, 1.3, 1.4 (JV) | 11.98 - | | 333701 | | | | 341953 | | |
| | | 910081 SM1204 | | | | | | | |
| 1.0, 1.25, 1.3, 1.4 (JV) | 8.95 - 10.98 | | 333702 | | | | 341712 | | |
| | | 910081 SM1204 | | | | | | | |
| 1.0, 1.25, 1.3, 1.4 (JV) | 11.98 - | | 333702 | | | | 341953 | | |
| | | 910081 SM1204 | | | | | | | |
| 1.8 D (JV) | 8.95 - 10.98 | | 333703 | | | | 341712 | | |
| | | 910081 SM1204 | | | | | | | |
| 1.8 D (JV) | 11.98 - | | 333703 | | | | 341953 | | |
| | | 910081 SM1204 | | | | | SM9200 | | |
| 1.8 D (JV) | 8.95 - 10.98 | | 333704 | | | | 341712 | | |
| | | 910081 SM1204 | | | | | | | |
| 1.8 D (JV) | 11.98 - | | 333704 | | | | 341953 | | |
| | | 910081 SM1204 | | | | | SM9200 | | |
| 1.8 TD (JV) | 3.00 - | | | | | | 341953 | | |
| | | 910081 SM1204 | | | | | SM9200 | | |
| Courier 1.3, 1.4 (J3, J5) | 96 - | | 333701 | | | | 343273 | | |
| | | 910081 SM1204 | | | | | | | |
| Courier 1.3, 1.4 (J3, J5) | 96 - | | 333702 | | | | 343273 | | |
| | | 910081 SM1204 | | | | | | | |
| Courier 1.8 D (J3, J5) | 96 - | | 333703 | | | | 343273 | | |
| | | 910081 SM1204 | | | | | | | |



| MODEL FAHRZEUG MODELE | YEAR JAHR ANNEE | FRONT/VORNE/AVANT | | | | REAR/HINTEN/ARRIERE | | | |
|--|----------------------------|-----------------------------|-----------------------------|--------------------------------|---------|-----------------------------|-----------------------------|--------------------------------|--|
| | | PREMIUM Twin-tube Oil | EXCEL-G Twin-tube Gas | GAS-A-JUST Mono-tube Gas | | PREMIUM Twin-tube Oil | EXCEL-G Twin-tube Gas | GAS-A-JUST Mono-tube Gas | |
| Ford Commercial (Europe) | | | | | | | | | |
| Fiesta Van, Courier | | | | | | | | | |
| Courier 1.8 D ⊕ ⊕ | (J3, J5) | 96 - | | 333704 | | | 343273 | | |
| | | | 910081 | SM1204 | | | | | |
| Courier 1.8 DI | (J3, J5) | 9.00 - | | | | | | | |
| | | | 910081 | SM1204 | | | | | |
| Fiesta Van (10.03-) → Ford Fiesta V | | | | | | | | | |
| Sierra | | | | | | | | | |
| PE 45 | | 88 - | | | | 444134 | | | |
| | | | 915201 | SM1200 | | | | | |
| Tourneo Connect / Transit Connect | | | | | | | | | |
| 1.8 i 1.8 Di 1.8 TDCi | 9.02 - 9.02 - 9.02 - | | | 334630 L 334629 R | | | 344486 | | |
| | | | 910104 | SM5581 | | | | | |
| Tourneo Connect, Grand Tourneo Connect (14-) | | | | | | | | | |
| 1.5 TDCi Incl. Ecolite serie | 5.15 - | | | | | | 3450002 | | |
| | | | | SM5589 ¹⁾ | | | | | |
| 1.6 EcoBoost, 1.6 TDCi ⊕ SHORT ⊕ 105V/115V series Exc. 95V/100V/110V/130V series | 9.13 - | | | | | | 3450002 | | |
| | | | | SM5589 ¹⁾ | | | | | |
| 1.0 EcoBoost, 1.6 EcoBoost, 1.6 TDCi ⊕ LONG | 9.13 - | | | | | | 3450002 | | |
| | | | | SM5589 ¹⁾ | | | | | |
| 1) Exc. 6-speed | | | | | | | | | |
| Tourneo Courier | | | | | | | | | |
| | (B460) | 2.14 - | | 3348033 L 3348032 R | | | 3438002 | | |
| | | | | | | | SM5802 | | |
| Tourneo Custom (13-) | | | | | | | | | |
| | | 4.12 - | | | | | 3440045 | | |
| | | | | | | | | | |
| Transit = 2.69m (106") | | | | | | | | | |
| 75, 100 | 9.70 - | 77 | 444029 | | 554048▼ | | 444030 | 344033▼ | |
| | | | | | | | | | |
| 75, 100, 125 | 9.70 - | 77 | 444029 | | 554048▼ | | 444030 | 344033▼ | |
| | | | | | | | | | |
| 80, 100, 120 | 78 - | 10.85 | 444029 | | 554048▼ | | 444030 | 344033▼ | |
| | | | | | | | | | |
| 100 100, 125 | 78 - | 10.85 78 - 10.85 | 444029 | | 554048▼ | | 444030 | 344033▼ | |
| | | | | | | | | | |
| Transit = 3.02m (118") | | | | | | | | | |
| 125, 130, 150, 160, 175 | 9.70 - | 77 | 444029 | | 554048▼ | | 444030 | 344033▼ | |
| | | | | | | | | | |



Ford

| MODEL FAHRZEUG MODELE | YEAR JAHR ANNEE | FRONT/VORNE/AVANT | | | | REAR/HINTEN/ARRIERE | | | |
|--|----------------------------|-----------------------------|-----------------------------|--------------------------------|--|-----------------------------|-----------------------------|--------------------------------|--|
| | | PREMIUM Twin-tube Oil | EXCEL-G Twin-tube Gas | GAS-A-JUST Mono-tube Gas | | PREMIUM Twin-tube Oil | EXCEL-G Twin-tube Gas | GAS-A-JUST Mono-tube Gas | |
| Ford Commercial (Europe) | | | | | | | | | |
| Transit = 3.02m (118") | | | | | | | | | |
| 100 L, 130, 150, 160, 190 | 78 - 10.85 | 444029 | | 554048▼ | | 444030 | 344033▼ | | |
| ALL | 78 - 10.85 | 444029 | | 554048▼ | | 444030 | 344033▼ | | |
| Transit = 2.82m | | | | | | | | | |
| 80, 100, 115, 120 | 11.85 - 9.91 | 635001 | | | | 444094 | | 554064▼ | |
| Transit = 3.02 m, 3.47 m | | | | | | | | | |
| 100 L, 130, 160, 190 | 11.85 - 9.91 | 443243 | | 553164▼ | | 444094 | | 554064▼ | |
| Transit = 2.835 m (Incl. Transit Tourneo) | | | | | | | | | |
| 100, 115 80, 120 | 9.91 - 7.94 8.91 - 7.95 | 635800 | 335800 | | | 444124 | | | |
| | | | SM1208 | | | | | | |
| 80, 120 Incl. Transit Tourneo | 8.95 - 00 | 635800 | 335800 | | | 444124 | | | |
| | | | SM1208 | | | | | | |
| 150 S | 9.91 - 7.95 | 635800 | 335800 | | | 444124 | | | |
| | | | SM1208 | | | | | | |
| 150 S Incl. Transit Tourneo | 8.95 - 00 | 635800 | 335800 | | | 444124 | | | |
| | | | SM1208 | | | | | | |
| Transit = 3.570m (Incl. Transit Tourneo) | | | | | | | | | |
| 130 | 9.91 - 7.95 | 635800 | 335800 | | | 444125 | | 554085▼ | |
| | | | SM1208 | | | | | | |
| 130 Incl. Transit Tourneo | 8.95 - 00 | 635800 | 335800 | | | 444125 | | 554085▼ | |
| | | | SM1208 | | | | | | |
| 190 190 EF | 9.91 - 7.95 8.94 - 7.95 | 635800 | 335800 | | | 444124 | | | |
| | | | SM1208 | | | | | | |
| 190 190 EF Incl. Transit Tourneo | 8.95 - 00 | 635800 | 335800 | | | 444124 | | | |
| | | | SM1208 | | | | | | |
| 100L, 150L, 190L | 9.91 - 7.95 | 635800 | 335800 | | | 444124 | | | |
| | | | SM1208 | | | | | | |
| 100L, 150L, 190L Incl. Transit Tourneo | 8.95 - 00 | 635800 | 335800 | | | 444124 | | | |
| | | | SM1208 | | | | | | |
| Transit (00- 06) | | | | | | | | | |
| 2.0 D, 2.0 TD Exc. | 3.00 - 6.06 | | 335804 | | | | 343393 | | |
| | | 910015 | SM1212 | | | | | | |
| 2.0 D, 2.0 TD Exc. | 3.00 - 6.06 | | 335804 | | | | 343399 | | |
| | | 910015 | SM1212 | | | | | | |



| MODEL FAHRZEUG MODELE | YEAR JAHR ANNEE | FRONT/VORNE/AVANT | | | | REAR/HINTEN/ARRIERE | | | |
|-----------------------------|-----------------------|-----------------------------|-----------------------------|--------------------------------|--|-----------------------------|-----------------------------|--------------------------------|--|
| | | PREMIUM Twin-tube Oil | EXCEL-G Twin-tube Gas | GAS-A-JUST Mono-tube Gas | | PREMIUM Twin-tube Oil | EXCEL-G Twin-tube Gas | GAS-A-JUST Mono-tube Gas | |

Ford Commercial (Europe)

Transit (00-06)

| | | | | | | | | | |
|---|-------------|--|--------|--------|--|--|--------|--|--|
| 2.4 D, 2.4 TD Exc. | 3.00 - 6.06 | | 335804 | | | | 343392 | | |
| | | | 910015 | | | | | | |
| | | | | SM1212 | | | | | |
| 2.4 TD, 2.4 TDi 2.4 D, 2.4 TD Exc. | 3.00 - 6.06 | | 335804 | | | | 343391 | | |
| | | | 910015 | | | | | | |
| | | | | SM1212 | | | | | |
| 2.3 i 16V | 1.01 - 6.06 | | 335805 | | | | | | |
| | | | 910015 | | | | | | |

Transit (06-)

| | | | | | | | | | |
|---|--------|--|--------|--------|--|--|--|--|--|
| 260S, 280S, 280M, 300L, 300M, 300S 300M, 300S | 4.06 - | | 335819 | | | | | | |
| | | | 910129 | | | | | | |
| | | | | SM5671 | | | | | |
| 330L, 330M, 350L, 350M | 4.06 - | | 335820 | | | | | | |
| | | | 910129 | | | | | | |
| | | | | SM5671 | | | | | |
| 300S, 330S, 350E, 350L, 350M 300L, 300M, 330L, 330M, 430E 430E, 430L, 430M, 460E, 460L, 460M | 4.06 - | | 335820 | | | | | | |
| | | | 910129 | | | | | | |
| | | | | SM5671 | | | | | |
| 430E, 430L, 430M 3.2 TDCi | 4.06 - | | 335820 | | | | | | |
| | | | 910129 | | | | | | |
| | | | | SM5671 | | | | | |
| 350E, 350L 3.2 TDCi | 4.06 - | | 335820 | | | | | | |
| | | | 910129 | | | | | | |
| | | | | SM5671 | | | | | |

Transit (06-)

| | | | | | | | | | |
|---|--------|--|--|--|--|--|----------------------|--|--|
| 260S, 280S, 300S, 280M, 300M, 300L 2.2 TDCi (63 kW, 81 kW, 103 kW) | 7.06 - | | | | | | 349080 ¹⁾ | | |
| | | | | | | | | | |
| 330M, 350M, 330L, 350L 2.2 TDCi (63 kW, 81 kW, 103 kW) | 7.06 - | | | | | | 349080 ¹⁾ | | |
| | | | | | | | | | |
| 300S, 330S 2.2 TDCi (81 kW, 103 kW) | 7.06 - | | | | | | 349083 ¹⁾ | | |
| | | | | | | | | | |
| 370 L 2.4 TDCi (74 kW, 85 kW, 103 kW) | 7.06 - | | | | | | 349082 ¹⁾ | | |
| | | | | | | | | | |
| 370 EL 2.4 TDCi (74 kW, 85 kW, 103 kW) | 7.06 - | | | | | | 349082 ¹⁾ | | |
| | | | | | | | | | |



| KYB | Lmax |
|--------|--------|
| 349080 | 480 mm |
| 349083 | 578 mm |
| 349081 | 610 mm |
| 349082 | 635 mm |



Ford

| MODEL FAHRZEUG MODELE | YEAR JAHR ANNEE | FRONT/VORNE/AVANT | | | | REAR/HINTEN/ARRIERE | | | |
|-----------------------------|-----------------------|-----------------------------|-----------------------------|--------------------------------|--|-----------------------------|-----------------------------|--------------------------------|--|
| | | PREMIUM Twin-tube Oil | EXCEL-G Twin-tube Gas | GAS-A-JUST Mono-tube Gas | | PREMIUM Twin-tube Oil | EXCEL-G Twin-tube Gas | GAS-A-JUST Mono-tube Gas | |

Ford Commercial (Europe)

Transit (06-)

| | | | | | | | | | |
|---|------------------|--|--|--|--|--|----------------------|--|--|
| 330S 2.4 TDCi (74 kW, 85 kW, 103 kW) 2.3 | 7.06 - 7.06 - | | | | | | 349081 ¹⁾ | | |
| 300M, 330M, 350M, 300L 330L, 350L, 350EL 2.3, 2.4 TDCi (kW : 74, 85, 103) | 7.06 - | | | | | | 349081 ¹⁾ | | |
| 330S 2.3, 2.4 TDCi (kW : 74, 85, 103) | 7.06 - | | | | | | 349081 ¹⁾ | | |
| 350M 2.4 TDCi (kW : 74, 85, 103) | 7.06 - | | | | | | 349082 ¹⁾ | | |
| 350L, 460EF 2.4 TDCi (kW : 74, 85, 103) | 7.06 - | | | | | | 349082 ¹⁾ | | |



| KYB | Lmax |
|--------|--------|
| 349080 | 480 mm |
| 349083 | 578 mm |
| 349081 | 610 mm |
| 349082 | 635 mm |

Transit Tourneo (06- 14)

| | | | | | | | | | |
|----------|--------|--|--|--|--|--|--------|--|--|
| 2.2 TDCi | 7.06 - | | | | | | 349114 | | |
|----------|--------|--|--|--|--|--|--------|--|--|

910129 SM5671

Transit (14-)

| | | | | | | | | | |
|--|--------|--|--|--|--|--|---------|--|--|
| 350 2.0 TDCi, 2.2 TDCi Exc. Special purpose vehicle, premier series | 8.13 - | | | | | | 3440045 | | |
| 310, 350, 410 2.0 EcoBlue mHEV | 5.19 - | | | | | | 3440045 | | |
| 310, 330 2.2 TDCi | 8.13 - | | | | | | 3440074 | | |
| 350 2.2 TDCi Exc. Stripped chassis | 8.13 - | | | | | | 3440074 | | |
| 350 2.2 TDCi Stripped chassis | 8.13 - | | | | | | 3440045 | | |



| MODEL FAHRZEUG MODELE | YEAR JAHR ANNEE | FRONT/VORNE/AVANT | | | | REAR/HINTEN/ARRIERE | | | |
|--|-----------------------|-----------------------------|-----------------------------|--------------------------------|--|-----------------------------|-----------------------------|--------------------------------|--|
| | | PREMIUM Twin-tube Oil | EXCEL-G Twin-tube Gas | GAS-A-JUST Mono-tube Gas | | PREMIUM Twin-tube Oil | EXCEL-G Twin-tube Gas | GAS-A-JUST Mono-tube Gas | |
| Ford Commercial (Europe) | | | | | | | | | |
| Transit Connect (14-) | | | | | | | | | |
| 1.0 EcoBoost, 1.5 TDCi, 1.6 EcoBoost (110 kW), 1.6 TDCi | 2.13 - | | | | | | 3450002 | | |
| 1) Exc. 6-speed | | | | | | | | | |
| Transit Courier | | | | | | | | | |
| (B460) | 2.14 - | | 3348033 L 3348032 R | | | | 3438002 | | |
| (B460) | 2.14 - 7.16 | | 3348033 L 3348032 R | | | | 3438002 | | |
| (B460) | 8.16 - | | 3348033 L 3348032 R | | | | | | |
| (B460) | 2.14 - | | 3348033 L 3348032 R | | | | 3438002 | | |
| Transit Custom (13-) | | | | | | | | | |
| 300, 310, 330, 340 2.0 TDCi, 2.2 TDCi | 4.12 - | | | | | | 3440045 | | |
| 250, 270, 290, 310, 330 2.2 TDCi | 4.12 - | | | | | | 3440045 | | |
| 340 2.0 TDCi (96 kW, 125 kW) | 12.15 - | | | | | | 3440045 | | |
| Ford-Mercury (US) | | | | | | | | | |
| Aerostar Mini Van | | | | | | | | | |
| | 89 - 97 | | 344083 ▼ | | | | 344290 | | |
| | 90 - 97 | | | | | | 344290 | | |
| Explorer | | | | | | | | | |
| | 91 - 10.94 | | 344268 | | | | 344269 | 555015 ▼ | |
| | 11.94 - 01 | | 341302 | 551090 ▼ | | | 344269 | 555015 ▼ | |
| Probe | | | | | | | | | |
| 2.0 16V 2.5 24V | 93 - | | | | | | 334217 | | |
| <div style="display: flex; justify-content: space-around; align-items: center;"> SM5308 SM5093 L ▼ SM5094 R ▼ </div> | | | | | | | | | |



GAZ

| MODEL FAHRZEUG MODELE | YEAR JAHR ANNEE | FRONT/VORNE/AVANT | | | | REAR/HINTEN/ARRIERE | | | |
|---|-----------------------|-----------------------------|-----------------------------|--------------------------------|--|-----------------------------|-----------------------------|--------------------------------|--|
| | | PREMIUM Twin-tube Oil | EXCEL-G Twin-tube Gas | GAS-A-JUST Mono-tube Gas | | PREMIUM Twin-tube Oil | EXCEL-G Twin-tube Gas | GAS-A-JUST Mono-tube Gas | |
| Ford-Mercury (US) | | | | | | | | | |
| Ranger (Exc. High Ryder Option) | | | | | | | | | |
| Exc. , EDGE model | 2.99 - 6.06 | 443216 | 343324▼ | 553171 | | 443259 | 343252▼ | 553209 | |
| | 2.99 - 6.06 | 444135 | 344305 | 554100 | | 444136 | 344304 | 554101 | |
| 2.2 TDCi (kW : 92, 96, 110) Exc. | (TKE) 4.11 - | | 340106 | | | | | | |
| 2.5i 2.2 TDCi, 3.2 TDCi Exc. | (TKE) 4.11 - | | 340106 | | | | | | |
| Windstar Mini Van | | | | | | | | | |
| | 95 - | | | | | | 344291 | | |
| Exc. | | | | | | | | | |
| Freight Rover (GB) → Austin-Rover Group (GB) | | | | | | | | | |
| | | | | | | | | | |
| GAZ (RUS) | | | | | | | | | |
| Volga 3102, 31029, 31022, 3110 | | | | | | | | | |
| Volga 3102, 31029, 31022, 3110 | 82 - 94 | | 344014 | | | | 344275 ¹⁾ | | |
| 1) GAZ 3110 : Exc. with 6 leaf | | | | | | | | | |
| GAZ Commercial (RUS) | | | | | | | | | |
| Gazel | | | | | | | | | |
| Gazel 3221, 3302, 33023, 2705 | 94 - | | 344471 | | | | 344471 | | |
| Sobol | | | | | | | | | |
| Sobol 2217, 22171, 2752 | 98 - | | | 554337 | | | 344471 | | |
| General Motors - Avtovaz (RUS) | | | | | | | | | |
| Chevrolet Niva | | | | | | | | | |
| | 02 - | 444266 | 344441 | | | 444267▼ | 344442 | | |



| MODEL FAHRZEUG MODELE | YEAR JAHR ANNEE | FRONT/VORNE/AVANT | | | | REAR/HINTEN/ARRIERE | | | |
|---|----------------------------|-----------------------------|--|--------------------------------|--|-----------------------------|-----------------------------|--------------------------------|--|
| | | PREMIUM Twin-tube Oil | EXCEL-G Twin-tube Gas | GAS-A-JUST Mono-tube Gas | | PREMIUM Twin-tube Oil | EXCEL-G Twin-tube Gas | GAS-A-JUST Mono-tube Gas | |
| General Motors - Buick - Cadillac - Chevrolet - GMC Truck - Pontiac (US) | | | | | | | | | |
| Astro, Safari Mini Van | | | | | | | | | |
| | 85 - 90 | | 344081 | | | | 344082 | | |
| | 91 - | | 344081 | | | | 344082 | | |
| | 91 - | | 344266 | | | | 344082 | | |
| BLS | | | | | | | | | |
| 1.9 D (110 kW), 2.0T, 2.8T (188 kW) | 4.06 - | | | | | | | | |
| SM1311 | | | | | | | | | |
| Century, Special, Celebrity | | | | | | | | | |
| | 84 - 96 | | 333145▼ | | | | 343160 | | |
| Lumina APV Mini Van, Trans Sport Mini Van | | | | | | | | | |
| | 84 - 96 | | 333145▼ | | | | 343160 | | |
| Exc. | | | | | | | | | |
| Orlando | | | | | | | | | |
| 1.4 (J309) 1.8, 2.0 D 1.8 LPG | 6.12 - 2.11 - 6.11 - | | 339374 L ¹⁾ 339373 R ¹⁾ | | | | 349234 | | |
| 910222 SM1008 | | | | | | | | | |
| 1) Exc. 2.0 D | | | | | | | | | |
| S-Series - Blazer, Jimmy, Sonoma | | | | | | | | | |
| | 82 - 05 | | | | | | 344041 | | |
| Exc. ZR2 Wide Stance Package Exc. ZR2 High Rider Package | 82 - 05 | | 344042 | | | | 344041 | | |
| Volt | | | | | | | | | |
| | 11.11 - | | | | | | | | |
| 910222 SM1008 | | | | | | | | | |
| General Motors - Hummer (US) | | | | | | | | | |
| H2 | | | | | | | | | |
| | 03 - 07 | | | 554319 | | | | 554197 | |
| H3 | | | | | | | | | |
| | 06 - 08 | | | 555049 | | | | 555050 | |
| GMC Truck (US) → General Motors (US) | | | | | | | | | |



| MODEL FAHRZEUG MODELE | YEAR JAHR ANNEE | FRONT/VORNE/AVANT | | | | REAR/HINTEN/ARRIERE | | | |
|---|--|-----------------------------|-----------------------------|--------------------------------|--|-----------------------------|-----------------------------|--------------------------------|--|
| | | PREMIUM Twin-tube Oil | EXCEL-G Twin-tube Gas | GAS-A-JUST Mono-tube Gas | | PREMIUM Twin-tube Oil | EXCEL-G Twin-tube Gas | GAS-A-JUST Mono-tube Gas | |
| Hillman (GB) → Talbot (F) (GB) | | | | | | | | | |
| Honda (J) | | | | | | | | | |
| Accord / Vigor | | | | | | | | | |
| Accord III (CA 4, CA 5) 1600, 2000, 2000 i, 2000 i 16V | 5.85 - 9.89 | 441062 L▼ 441061 R▼ | 341073 L 341072 R | | | 441063 | 341074▼ | | |
| | | | | | | | | | |
| Accord IV (CB1, CB3) 1.8, 2.0, 2.0 i, 2.0 i 16V | 89 - 93 | | 341172 L 341171 R | | | | 341173 | | |
| | | | | | | | | | |
| Accord IV 2.2 | (CB7) 90 - 93 | | 341172 L 341171 R | | | | | | |
| | | | | | | | | | |
| Accord IV 2.0 2.2 | (CC9) (CB8, CB9) 91 - 93 | | 341172 L 341171 R | | | | 341176 | | |
| | | | | | | | | | |
| Accord IV 1.8, 2.0, 2.3 | (CC7) 93 - 96 | | 341172 L 341171 R | | | | 341173 | | |
| | | | | | | | | | |
| Accord V 1.8, 1.9 2.0 2.2 VTEC 2.0 Turbo Diesel | (CE7) (CE8) (CE9) (CF1) 96 - 10.98 | | 341172 L 341171 R | | | | 341173 | | |
| | | | | | | | | | |
| Accord V 2.0 | (CC1) 92 - 96 | | 341172 L 341171 R | | | | 341173 | | |
| | | | | | | | | | |
| Accord V 2.0 2.2 | (CD9) (CD7) 94 - 2.98 | | 341175 L 341174 R | | | | 341176 | | |
| | | | | | | | | | |
| Accord V 2.0 2.2 | (CE2) (CE1) 94 - 1.03 | | 341175 L 341174 R | | | | 341176 | | |
| | | | | | | | | | |
| Accord / Vigor | | | | | | | | | |
| Accord VI 1.6 1.8 2.0 2.2 Type-R 2.0 TD 2.3 | (CG7) (CG8) (CG9) (CH1) (CH2) (CK2) 10.98 - 1.03 | | 341255 | | | | 341256 | | |
| | | | | | | | | | |
| 1) Exc. 2.2 Type-R | | | | | | | | | |



| MODEL FAHRZEUG MODELE | YEAR JAHR ANNEE | FRONT/VORNE/AVANT | | | | REAR/HINTEN/ARRIERE | | | |
|---|--|-----------------------------|--|--------------------------------|--|-----------------------------|-----------------------------|--------------------------------|--|
| | | PREMIUM Twin-tube Oil | EXCEL-G Twin-tube Gas | GAS-A-JUST Mono-tube Gas | | PREMIUM Twin-tube Oil | EXCEL-G Twin-tube Gas | GAS-A-JUST Mono-tube Gas | |
| Honda (J) | | | | | | | | | |
| Accord / Vigor | | | | | | | | | |
| Accord VI 1.6 (CH5) 1.8 (CH6) 2.0 (CH7) 2.0 TD (CH8) 2.3 (CL4) | 10.98 - 1.03 | | 341255 | | | | 341256 | | |
| | | | 910019 ¹⁾ SM5058 | | | | SM5058 | | |
| Accord VI 2.0 16V (CG4) 3.0 V6 24V (CG2) | 2.98 - 1.03 | | 341257 | | | | 341258 | | |
| | | | 912047 SM5058 | | | | SM5058 | | |
| Accord VII 2.0 i (CL7) 2.4 i (CL9) 2.2 CDTi (CN1) | 2.03 - 2.03 - 2.04 - | | 341330 ²⁾ | | | | 341369 | | |
| | | | 910265 SM5058 | | | | 910133 SM5058 | | |
| Accord VII 2.0 i (CM1) 2.4 i (CM2) 2.2 CDTi (CN2) | 2.03 - 2.03 - 2.04 - | | 341330 ²⁾ | | | | 344462 | | |
| | | | 910265 SM5058 | | | | 910178 SM5058 | | |
| Accord VIII 2.0, 2.4, 2.2 i-DTEC (CU) | 6.08 - | | 340037 L 340036 R | | | | 340031 | | |
| | | | 910265 SM5789 L SM5790 R | | | | 910266 | | |
| Accord VIII 2.0, 2.4, 2.2 i-DTEC (CW) | 6.08 - | | 340037 L 340036 R | | | | | | |
| | | | 910265 SM5789 L SM5790 R | | | | 910266 | | |
| 1) Exc. 2.2 Type-R 2) Xe | | | | | | | | | |
| City | | | | | | | | | |
| (GM2, GM3) | 9.08 - | | | | | | | | |
| | | | 910267 SM5654 | | | | | | |
| Civic, Ballade | | | | | | | | | |
| Exc. = CVCC | 80 - 83 | | 333021 | | | | | | |
| 1200 (AL, AM) 1300 (AG, AJ) 1500 (AH, AK) | 84 - 87 | | | | | 441054 | 341050 | | |
| 1300 (EC8) 1400 (EC9, ED2) 1600 PGM-F1 (ED7, ED4) → S000001 | 1.88 - 12.88 | | 341086 L 341085 R | | | | 341093 | | |
| | | | SM5058 | | | | SM5058 | | |
| 1300 (EC8) 1400 (EC9, ED2) 1500 PGM-F1 (ED6, ED3) 1600 PGM-F1 (ED7, ED4) 1600 VTEC (EE9) S000001 → | 1.89 - 12.91 1.89 - 12.89 1.89 - 12.91 1.89 - 12.91 1.90 - 12.91 | | 341088 L 341087 R 351009 L 351008 R | | | | 341094 351010 | | |
| | | | SM5058 | | | | SM5058 | | |



| MODEL FAHRZEUG MODELE | YEAR JAHR ANNEE | FRONT/VORNE/AVANT | | | | REAR/HINTEN/ARRIERE | | | |
|--|----------------------------|-----------------------------|--|--------------------------------|--|-----------------------------|------------------------------|--------------------------------|--|
| | | PREMIUM Twin-tube Oil | EXCEL-G Twin-tube Gas | GAS-A-JUST Mono-tube Gas | | PREMIUM Twin-tube Oil | EXCEL-G Twin-tube Gas | GAS-A-JUST Mono-tube Gas | |
| Honda (J) | | | | | | | | | |
| Civic, Ballade | | | | | | | | | |
| 1.3 (EG3) 1.5 (EG4, EG8) 1.6 VTEC (EG5, EH9) 1.6 VTEC VTi (EG6, EG9) | 91 - 95 | | 341139 L 341138 R 351012 L 351011 R | | | | 341094 351010 | | |
| 1.4 (EJ9), 1.5 (EK3), 1.6 (EK1, EK4) Incl. VTEC | 95 - 01 | | 341203 | | | | 341198 | | |
| 1.4 (MA8, MB2), 1.4 LPG, 1.5 (MA9, MB3) 1.6 (MB1, MB4), 1.8 (MB6) 2.0 Turbo Diesel (MB7) Incl. VTEC | 95 - 01 | | 341234 L 341233 R | | | | 341131 | | |
| Aerodeck 1.4 (MA8), 1.4 LPG, 1.5 (MB9) 1.6 (MC1), 1.8 (MC2) 2.0 Turbo Diesel (MC3) Incl. VTEC | 98 - 01 | | 341234 L 341233 R | | | | 341131 | | |
| Civic CR-X / Ballade CR-X (: JHM ...) | | | | | | | | | |
| 1500 (AF) | 84 - 87 | | | | | 441054 | 341050 | | |
| 1600 Si (AS) | 86 - 87 | | | | | 441054 | 341050 | | |
| 1600 PGM-F1 (ED9) S000001 → S100001 | 1.88 - 12.88 | | 341086 L 341085 R | | | | 341093 | | |
| 1600 PGM-F1 (ED9) 1600 VTEC (EE8) S100001 → | 1.89 - 3.92 1.90 - 3.92 | | 341088 L 341087 R 351009 L 351008 R | | | | 341094 351010 | | |
| 1.6 VTEC (EH6) 1.6 VTEC VTi (EG2) | 4.92 - 98 | | 341139 L 341138 R 351012 L 351011 R | | | | 341094 351010 | | |
| Civic Coupé / Ballade Coupé (: 1HG ...) | | | | | | | | | |
| 1.5 (EJ2) 1.6 VTEC (EJ1) | 94 - 95 | | 341139 L 341138 R 351012 L 351011 R | | | | 341094 351010 | | |



| MODEL FAHRZEUG MODELE | YEAR JAHR ANNEE | FRONT/VORNE/AVANT | | | | REAR/HINTEN/ARRIERE | | | |
|---|-----------------------|-----------------------------|--|--------------------------------|--|-----------------------------|-----------------------------|--------------------------------|--|
| | | PREMIUM Twin-tube Oil | EXCEL-G Twin-tube Gas | GAS-A-JUST Mono-tube Gas | | PREMIUM Twin-tube Oil | EXCEL-G Twin-tube Gas | GAS-A-JUST Mono-tube Gas | |
| Honda (J) | | | | | | | | | |
| Civic Coupé / Ballade Coupé (: 1HG ...) | | | | | | | | | |
| 1.6 (EJ6) 1.6 VTEC (EJ7, EJ8, EM1) | 95 - 01 | | 341203 | | | | 341198 | | |
| | | | SM5058 | | | | SM5058 | | |
| Civic Shuttle / Ballade Shuttle | | | | | | | | | |
| 1500 (AN) | 84 - 87 | | | | | | 341077▼ | | |
| 1400 (EE1), 1500 (EE2), 1600 (EE4) S000001 → S100001 | 1.88 - 12.88 | | | | | | 341095 | | |
| | | | SM5058 | | | | SM5058 | | |
| 1400 (EE1), 1500 (EE2), 1600 (EE4) S100001 → S200001 | 1.89 - 12.89 | | 341092 L▼ 341091 R▼ | | | | 341096▼ | | |
| | | | SM5058 | | | | SM5058 | | |
| 1400 (EE1), 1500 (EE2), 1600 (EE4) S200001 → | 1.90 - 95 | | 341092 L▼ 341091 R▼ | | | | 341095 | | |
| | | | SM5058 | | | | SM5058 | | |
| Civic | | | | | | | | | |
| (EM2) | 01 - | | 331009 L 331008 R | | | | 341311 | | |
| | | | 910018 SM5403 ¹⁾ SM5402 ²⁾ | | | | 910102 SM5400 | | |
| 1.4 i (EP1) 1.6 i (EP2) | 9.01 - | | 331009 L 331008 R | | | | 341311 | | |
| | | | 910018 SM5403 | | | | 910102 SM5401 | | |
| 1.7 CTDi (EP4) | 4.02 - | | 331011 L 331010 R | | | | 341311 | | |
| | | | 910018 SM5403 | | | | 910102 SM5401 | | |
| 2.0 Type-R (EP3) | 01 - | | 331011 L 331010 R | | | | 341311 | | |
| | | | 910018 SM5403 | | | | 910103 SM5401 | | |
| 1.4 i (EU5/7) 1.6 i (EU6/8) | 4.01 - | | 331009 L 331008 R | | | | 341311 | | |
| | | | 910018 SM5403 | | | | 910102 SM5401 | | |
| 1.7 CTDi (EU9) 2.0 i Sport (EV1) | 4.02 - 9.03 - | | 331011 L 331010 R | | | | 341311 | | |
| | | | 910018 SM5403 | | | | 910102 SM5401 | | |
| 1.4 i (ES4) 1.6 i (ES5) | 4.01 - 12.02 | | 331009 L 331008 R | | | | 341311 | | |
| | | | 910018 SM5403 ¹⁾ SM5402 ²⁾ | | | | 910102 SM5400 | | |
| 1.4 i (ES4) | 1.03 - | | 331009 L 331008 R | | | | 341311 | | |
| | | | 910018 SM5402 | | | | 910102 SM5400 | | |
| 1) → 02 2) 02 → | | | | | | | | | |



| MODEL FAHRZEUG MODELE | YEAR JAHR ANNEE | FRONT/VORNE/AVANT | | | | REAR/HINTEN/ARRIERE | | | |
|---|-----------------------|-----------------------------|-----------------------------|--------------------------------|--|-----------------------------|-----------------------------|--------------------------------|--|
| | | PREMIUM Twin-tube Oil | EXCEL-G Twin-tube Gas | GAS-A-JUST Mono-tube Gas | | PREMIUM Twin-tube Oil | EXCEL-G Twin-tube Gas | GAS-A-JUST Mono-tube Gas | |
| Honda (J) | | | | | | | | | |
| Civic | | | | | | | | | |
| 1.6 i (ES5) | 1.03 - | | 331011 L 331010 R | | | | | | |
| | | 910018 | SM5402 | | | 910102 | | | |
| Civic VII 1.3 IMA (ES) | 10.03 - 9.05 | | | | | | | | |
| | | | SM5402 | | | 910102 | | | |
| Civic VIII ALL Exc. Type R (FK) | 9.05 - | | 339723 L 339722 R | | | | | 553365 | |
| | | 910132 | SM1052 ¹⁾ | | | | | | |
| Civic VIII ALL Exc. Hybrid (FD) | 9.05 - | | 339203 L 339202 R | | | | | | |
| | | | SM5615 | | | | | | |
| Civic VIII Hybrid ALL (FD) | 9.05 - | | | | | | 343460 | | |
| | | | | | | | SM5615 | | |
| Civic VIII ALL Exc. Hybrid (FD) | 06 - | | 339075 L 339074 R | | | | 343479 | | |
| | | | SM5615 | | | | | | |
| Civic VIII Hybrid ALL 1.3 (FD) | 06 - | | | | | | 348078 | | |
| | | | | | | | | | |
| Civic VIII ALL Exc. Hybrid (FD) | 06 - | | 339203 L 339202 R | | | | 348019 | | |
| | | 910132 | SM5615 | | | | | | |
| Civic IX ALL 1.6, 1.8 (FB) | 1.12 - | | 339280 L 339279 R | | | | 348066 | | |
| | | | | | | | | | |
| Civic IX 1.4 i-VTEC, 1.8 i-VTEC, 2.2 i-DTEC (FK) | 2.12 - | | 3348055 L 3348054 R | | | | | 553365 ²⁾ | |
| | | | | | | | | | |
| Civic X 1.0 VTEC, 1.5 VTEC (134 kW) 1.6 i-DTEC Exc. Type-R, (FC_, FK_) 8.16 - | | | | | | | 3430036 | | |
| | | | | | | | | | |
| 1) Incl. Type R 2) | | | | | | | | | |
| Concerto | | | | | | | | | |
| 1.4, 1.5 i, 1.6, 1.6 i (HW) | 90 - 96 | | 334069 L 334068 R | | | | 341131 | | |
| | | | | | | | SM5058 | | |
| CR-V | | | | | | | | | |
| CR-V I (RD1, RD3) | 10.95 - 2.02 | | 341260 | | | | 341261 | | |
| | | | SM5058 | | | | SM5058 | | |



| MODEL FAHRZEUG MODELE | YEAR JAHR ANNEE | FRONT/VORNE/AVANT | | | | REAR/HINTEN/ARRIERE | | | |
|---|--|-----------------------------|-----------------------------|--------------------------------|--|-----------------------------|-----------------------------|--------------------------------|--|
| | | PREMIUM Twin-tube Oil | EXCEL-G Twin-tube Gas | GAS-A-JUST Mono-tube Gas | | PREMIUM Twin-tube Oil | EXCEL-G Twin-tube Gas | GAS-A-JUST Mono-tube Gas | |
| Honda (J) | | | | | | | | | |
| CR-V | | | | | | | | | |
| CR-V II 2.0 | (RD_) 3.02 - 12.04 | | 331051 L 331050 R | | | | 341463 | | |
| | | 935307 | SM5403 | | | 935309 | SM5400 | | |
| CR-V II 2.0 | (RD_) 1.05 - 9.06 | | 331049 L 331048 R | | | | 341463 | | |
| | | 935307 | SM5403 | | | 935309 | SM5400 | | |
| CR-V II 2.2 CDTi | (RD_) 1.05 - 9.06 | | 331045 L 331044 R | | | | 341463 | | |
| | | 935307 | SM5403 | | | 935309 | SM5400 | | |
| CR-V III 2.0 i-VTEC 2.2 i CTDi 2.2 i-DTEC 2.4 i-VTEC 2.4 Incl. | (RE) 1.07 - 11 1.07 - 11 1.07 - 11 9.09 - 11 4.07 - 11 | | 339262 L 339261 R | | | | 341492 | | |
| | | 910347 | SM5655▼ | | | 910248 ¹⁾ | SM5400 | | |
| CR-V IV 2.0 (110 kW) 2.4 (140 kW) | (RE) 1.12 - | | 339262 L 339261 R | | | | 340115 | | |
| CR-V IV 2.0 (114 kW), 2.2 i-DTEC \ | (RE) 10.12 - | | 339262 L 339261 R | | | | 340115 | | |
| CR-V IV 2.0 (114 kW), 2.2 i-DTEC / | (RE) 10.12 - | | 339262 L 339261 R | | | | 3410047◇ | | |
| 1) Exc. | | | | | | | | | |
| CR-Z | | | | | | | | | |
| | (ZF) 6.10 - | | | | | | | | |
| | | 910267 | SM5654 | | | | | | |
| Element | | | | | | | | | |
| | (RE) 03 - 06 | | 331047 L 331046 R | | | | 344611 | | |
| FR-V | | | | | | | | | |
| 1.7, 1.8, 2.0, 2.2 i CDTi ⊖ | 8.04 - | | | | | | 340035 | | |
| HR-V | | | | | | | | | |
| 1.6 16V | (GH) 3.99 - 00 | | 334244 L 334243 R | | | | 343315 ¹⁾ | | |
| | | 910070 | | | | | | | |
| 1) 343315 : O.E. = 52610-S2H-902, 52610-S2H-014 343316 : O.E. = 52610-S2J-951, 52610-S2H-951 | | | | | | | | | |



Honda

| MODEL FAHRZEUG MODELE | YEAR JAHR ANNEE | FRONT/VORNE/AVANT | | | | REAR/HINTEN/ARRIERE | | | |
|---|---------------------------------------|-----------------------------|-----------------------------|--------------------------------|--|-----------------------------|-----------------------------|--------------------------------|--|
| | | PREMIUM Twin-tube Oil | EXCEL-G Twin-tube Gas | GAS-A-JUST Mono-tube Gas | | PREMIUM Twin-tube Oil | EXCEL-G Twin-tube Gas | GAS-A-JUST Mono-tube Gas | |
| Honda (J) | | | | | | | | | |
| HR-V | | | | | | | | | |
| (2WD) 1.6 16V | (GH) 00 - | | 334244 L 334243 R | | | | 343316 ¹⁾ | | |
| | | 910070 | | | | | | | |
| (4WD) 1.6 16V | (GH) 3.99 - 00 | | 334244 L 334243 R | | | | 343315 ¹⁾ | | |
| | | 910070 | | | | | | | |
| (4WD) 1.6 16V | (GH) 00 - | | 334244 L 334243 R | | | | 343316 ¹⁾ | | |
| | | 910070 | | | | | | | |
| 1) 343315 : O.E. = 52610-S2H-902, 52610-S2H-014 343316 : O.E. = 52610-S2J-951, 52610-S2H-951 | | | | | | | | | |
| Insight | | | | | | | | | |
| | (ZE_) 4.09 - | | | | | | | | |
| | | 910267 | | | | | | | |
| Jazz | | | | | | | | | |
| Jazz II 1.2, 1.4 | (GD) 3.02 - 3.05 | | 333332 L 333331 R | | | | 343381 | | |
| | | 910131 | | | | | | | |
| Jazz II 1.2, 1.4 1.3 iDSi | (GD) 4.05 - 7.08 10.07 - 7.08 | | 333411 L 333410 R | | | | 343381 | | |
| | | 910131 | | | | | | | |
| Jazz III 1.2, 1.3 i, 1.4 | (GE) 7.08 - | | 338002 L 338001 R | | | | 348016 | | |
| | | 910267 ¹⁾ | | | | | | | |
| 1) Incl. 1.3 Hybrid | | | | | | | | | |
| Legend | | | | | | | | | |
| 2.5 | (HS) 86 - 88 | | 341113 L 341112 R | | | | | | |
| | | | | | | | | | |
| 2.7 2.7 | (KA4) 89 - 90 (KA3) 89 - 90 | | 341113 L 341112 R | | | | 341116 | | |
| | | | | | | | | | |
| Logo | | | | | | | | | |
| 1.3 | (GA3) 3.99 - | | 332107 L 332106 R | | | | 343318 | | |
| Prelude | | | | | | | | | |
| 1800 2000 | (AB) 11.82 - 87 (BA2, BA3) 85 - 87 | | 341062 | | | | 333177 L▼ 333176 R▼ | | |
| | | | | | | | | | |
| 2.0 Incl. | (BA4) 88 - 92 | | 341073 L 341072 R | | | | 341180 | | |
| | | | | | | | | | |



| MODEL FAHRZEUG MODELE | YEAR JAHR ANNEE | FRONT/VORNE/AVANT | | | | REAR/HINTEN/ARRIERE | | | |
|--|-----------------------|-----------------------------|---|--|--|--|--|--------------------------------|--|
| | | PREMIUM Twin-tube Oil | EXCEL-G Twin-tube Gas | GAS-A-JUST Mono-tube Gas | | PREMIUM Twin-tube Oil | EXCEL-G Twin-tube Gas | GAS-A-JUST Mono-tube Gas | |
| Honda (J) | | | | | | | | | |
| Prelude | | | | | | | | | |
| 2.0, 2.3 2.2 VTEC Incl. | (BB3, BB2) (BB1) | 92 - 96 93 - 96 | | 341178 L 341177 R | | | 341179 | | |
| | | | | | | | | | |
| 2.0, 2.3 JHMBB9..., BB5... | (BB9, BB5) | 97 - 01 | | 341236 L 341235 R | | | 341179 | | |
| | | | | | | | | | |
| 2.2 VTEC JHMBB8... | (BB8) | 97 - 01 | | 341236 L 341235 R | | | 341179 | | |
| | | | | | | | | | |
| 2.2 VTEC VTI-R JHMBB614..., BB624... | (BB6) | 97 - 01 | | 341236 L 341235 R | | | 341179 | | |
| | | | | | | | | | |
| 2.2 VTEC VTI-S JHMBB615... | (BB6) | 97 - 01 | | | | | 341179 | | |
| | | | | | | | | | |
| Quintet | | | | | | | | | |
| | | 2.80 - 84 | | 333021 | | | | | |
| | | | | | | | | | |
| Shuttle / Odyssey | | | | | | | | | |
| 2.2 2.3 | (RA1) (RA3) | 95 - 01 | | 341201 L 341200 R | | | 344274 | | |
| | | | | | | | | | |
| Stream | | | | | | | | | |
| | (RN1, RN3) | 01 - | | 331013 L ¹⁾ 331012 R ¹⁾ | | | 341298 | | |
| | | | | | | | | | |
| 1) 331013 L : only for OE P/N : 51606-S7C-G03 51606-S7C-G04 | | | 331012 R : only for OE P/N : 51605-S7C-G03 51605-S7C-G04 | | | | | | |
| Hummer (US) → General Motors (US) | | | | | | | | | |
| Hyundai (KO) | | | | | | | | | |
| Accent | | | | | | | | | |
| Accent I Incl. ABS | (X3) | 7.94 - 5.97 | 633178 L▼ 633177 R▼ | 333212 L 333211 R | | 632104 L ¹⁾ ▼ 632103 R ¹⁾ ▼ | 332081 L ¹⁾ 332080 R ¹⁾ | | |
| | | | | | | | | | |
| 1) | | | | | | | | | |



Hyundai

| MODEL FAHRZEUG MODELE | YEAR JAHR ANNEE | FRONT/VORNE/AVANT | | | | REAR/HINTEN/ARRIERE | | | |
|---|-----------------------|-----------------------------|-----------------------------|--|--|--|--|--------------------------------|--|
| | | PREMIUM Twin-tube Oil | EXCEL-G Twin-tube Gas | GAS-A-JUST Mono-tube Gas | | PREMIUM Twin-tube Oil | EXCEL-G Twin-tube Gas | GAS-A-JUST Mono-tube Gas | |
| Hyundai (KO) | | | | | | | | | |
| Accent | | | | | | | | | |
| Accent I ALL Incl. ABS | (X3) | 5.97 - 1.00 | 633178 L▼ 633177 R▼ | 333212 L 333211 R | | 632113 L ¹⁾ ▼ 632112 R ¹⁾ ▼ | 332095 L ¹⁾ 332094 R ¹⁾ | | |
| | | | SM5149 | | | | | SM5148 | |
| Accent II ALL Incl. Sport sus., ABS | (LC) | 9.99 - 12.06 | | 333305 L 333304 R 323053 L 323052 R | | | 332109 L 332108 R | | |
| | | | 910021 SM5201 | | | | | 910062 SM5148 | |
| Accent III 1.4 GL, 1.6 GLS 1.5 CRDi GLS Exc. | (MC) | 11.05 - 11.10 | | 333517 L▼ 333516 R▼ 3330053 L 3330052 R | | | 348002 | | |
| | | | 910022 MB1901 SM5670 | | | | | 910175 SM5656 | |
| Accent IV 1.4, 1.6 CRDi (100 kW) | (RB) | 11.10 - | | 338107 L 338106 R | | | 349098 | | |
| | | | SM5818 ²⁾ | | | | | | |
| Accent IV 1.6 | (RB) | 11.10 - | | | | | 349098 | | |
| | | | SM5818 ²⁾ | | | | | | |
| Accent IV 1.6 CRDi (94 kW), 1.6 CVVT-i | (RB) | 11.10 - | | | | | | | |
| | | | SM5818 ²⁾ | | | | | | |
| 1) ø 173 mm 2) | | | | | | | | | |
| Atos | | | | | | | | | |
| ALL Incl. ABS | (MX) | 97 - 9.98 | 633205 L▼ 633204 R▼ | 333257 L 333256 R | | | 343432 | | |
| ALL Incl. ABS | (MX) | 10.98 - | | 333299 L 333298 R | | | 343432 | | |
| | | | 910020 | | | | | | |
| Atos Prime / Amica | | | | | | | | | |
| ALL Incl. ABS | (MX) | 8.99 - | | 333299 L 333298 R | | | 343432 | | |
| | | | 910020 | | | | | | |
| Azera / Grandeur | | | | | | | | | |
| 2.4, 2.4 16V, 3.0 GDi (184 kW), 3.0 GLS | (HG) | 1.11 - | | | | | 349244 | | |



| MODEL FAHRZEUG MODELE | YEAR JAHR ANNEE | FRONT/VORNE/AVANT | | | | REAR/HINTEN/ARRIERE | | | |
|---|-----------------------|-----------------------------|-----------------------------|--------------------------------|----------|-----------------------------|-----------------------------|--------------------------------|--|
| | | PREMIUM Twin-tube Oil | EXCEL-G Twin-tube Gas | GAS-A-JUST Mono-tube Gas | | PREMIUM Twin-tube Oil | EXCEL-G Twin-tube Gas | GAS-A-JUST Mono-tube Gas | |
| Hyundai (KO) | | | | | | | | | |
| Coupé | | | | | | | | | |
| KMHJ ..., KMHK ... Incl. ABS | (J2, RD) | 6.96 - 4.02 | | 333206 L 333205 R | | | 333208 L 333207 R | | |
| | | | | SM5193 | | 910111 ▼ 910270 | SM5239 L SM5240 R | | |
| 1.6 i 16V 2.0 i 16V 2.7 i V6 Incl. Sport sus. | (GK) | 8.01 - 8.09 | | 333509 L 333508 R | | | 333511 L 333510 R | | |
| | | | | SM5661 | | | SM5239 L SM5240 R | | |
| Elantra | | | | | | | | | |
| Incl. ABS | (XD) | 7.00 - 7.06 | | 333206 L 333205 R | | | 333782 L 333781 R | | |
| | | | | 910022 SM5193 | | 910150 | SM5239 L SM5240 R | | |
| | (HD) | 11.05 - 11.06 | | 338023 L 338022 R | | | 349085 | | |
| | | | | 910270 SM5668 | | | | | |
| | (HD) | 12.06 - 12.11 | | 338023 L 338022 R | | | 349085 | | |
| | | | | 910022 SM5668 | | | | | |
| 1.6 (96 kW) 1.6 (97 kW), 1.8 (110 kW), 1.8 GLS Exc. | (MD, UD) | 6.11 - 5.12 9.10 - 9.13 | | 3330049 L 3330048 R | | | | 554384 | |
| | | | | SM1050 ▼ | | | | | |
| 1.6 (96 kW) 1.6 (94 kW), 1.6 CRDi (94 kW) | (MD, UD) | 6.12 - 9.13 2.11 - 9.13 | | | | | | 554384 | |
| | | | | SM1050 ▼ | | | | | |
| Galoper | | | | | | | | | |
| | (JK-01) | 8.97 - 12.03 | | 344119 | 554061 ▼ | | 344116 | 554068 ▼ | |
| | | | | | | | | | |
| Getz | | | | | | | | | |
| | (TB) | 8.02 - 6.09 | | 333507 L 333506 R | | | 343398 | | |
| | | | | 910249 SM5201 | | 930002 | SM9943 | | |
| H100 | | | | | | | | | |
| | | 7.93 - 10.04 | 444128 | | 554095 ▼ | | 444023 | 553116 | |
| | | | | | | | | | |
| H1 / Starex / Satellite / H200 | | | | | | | | | |
| SHORT KMJ ... | | 97 - 07 | | 344285 | | | 344287 | | |
| | | | | | | | | | |
| LONG KMJ ... | | 97 - 07 | | 344285 | | | 344286 | | |
| | | | | | | | | | |
| = KMJ ... | | 97 - 07 | | 344285 | | | 344286 | | |
| | | | | | | | | | |



| Hyundai | MODEL FAHRZEUG MODELE | YEAR JAHR ANNEE | FRONT/VORNE/AVANT | | | | REAR/HINTEN/ARRIERE | | | |
|---|-----------------------------|-------------------------------|---|-----------------------------|--------------------------------|----------------|-----------------------------|-----------------------------|--------------------------------|--|
| | | | PREMIUM Twin-tube Oil | EXCEL-G Twin-tube Gas | GAS-A-JUST Mono-tube Gas | | PREMIUM Twin-tube Oil | EXCEL-G Twin-tube Gas | GAS-A-JUST Mono-tube Gas | |
| Hyundai (KO) | | | | | | | | | | |
| Highway Van | | | | | | | | | | |
| | Incl. ABS | 00 - | | 334238 L 334237 R | | | | 344297 | | |
| | | | SM5194 | | | | | | | |
| i10 | | | | | | | | | | |
| | (PA) | 10.07 - | | 332503 L 332502 R | | | | 349087 | | |
| | | | 910268 SM1015 | | | | | | | |
| i10 II | | | | | | | | | | |
| 1.0, 1.0 LPG, 1.2 | (BA, IA) | 8.13 - | | | | | | 3430029 | | |
| | | | 910340 | | | 910335 SM9943 | | | | |
| Grand i10 | | | | | | | | | | |
| | | 08.15 - | | | | | | 3430029 | | |
| | | | 910340 | | | 910335 SM9943 | | | | |
| i10 III | | | | | | | | | | |
| 1.0 MPI, 1.2 MPI | (AC3, AI3) | 9.19 - | | | | | | 3430029 | | |
| i20 | | | | | | | | | | |
| | (PB, PBT) | 8.08 - | | | | | | 349098 | | |
| | | | 910249 | | | | | | | |
| i20 II | | | | | | | | | | |
| 1.0 T-GDI, 1.2 (55 kW, 62 kW) 1.2 LPG, 1.2 LPGI, 1.4 1.1 CRDi, 1.4 CRDi (66 kW) | (GB, IB) | 11.14 - | | | | | | 3430050 | | |
| i20 II | | | | | | | | | | |
| 1.0 T-GDI, 1.2 (62 kW), 1.4 1.1 CRDi, 1.4 CRDi | (GB) | 5.15 - | | | | | | 3430050 | | |
| i20 Active | | | | | | | | | | |
| 1.0 T-GDI, 1.4 (74 kW) 1.4 CRDi | (IB, GB) | 9.15 - 3.18 | | | | | | 3430064 | | |
| ix20 | | | | | | | | | | |
| 1.4, 1.4 LPG, 1.6 1.4 CRDi, 1.6 CRDi | (JC) | 11.10 - 12.14 11.10 - 3.15 | | 3330122 L 3330121 R | | | | 349098 | | |
| | | | 910269 ¹⁾ SM5818 ²⁾ | | | | | | | |
| 1.4, 1.4 LPG, 1.6 1.6 LPG 1.4 CRDi, 1.6 CRDi | (JC) | 1.15 - 11.10 - 4.15 - | | | | | | 349098 | | |
| | | | 910269 ¹⁾ SM5818 ²⁾ | | | | | | | |
| 1) → 1.15 2) → 10.14 | | | | | | | | | | |



| MODEL FAHRZEUG MODELE | YEAR JAHR ANNEE | FRONT/VORNE/AVANT | | | | REAR/HINTEN/ARRIERE | | | |
|-----------------------------|-----------------------|-----------------------------|-----------------------------|--------------------------------|--|-----------------------------|-----------------------------|--------------------------------|--|
| | | PREMIUM Twin-tube Oil | EXCEL-G Twin-tube Gas | GAS-A-JUST Mono-tube Gas | | PREMIUM Twin-tube Oil | EXCEL-G Twin-tube Gas | GAS-A-JUST Mono-tube Gas | |

Hyundai (KO)

i30 I

| | | | | | | | | |
|--|------|---------------|-----------------------------------|--|--|----------------|--|--|
| | (FD) | 10.07 - 11.11 | | 338025 L ¹⁾ 338024 R ¹⁾ | | 349084 | | |
| | | | 910147▼ MB1901 910022 SM5668 | | | 910179 SM5669 | | |

1) →7.10
Exc. 1.6 CRDi (94 kW)

i30 CW I

| | | | | | | | | |
|--|------|--------------|-----------------------------------|--|--|----------------|--|--|
| | (FD) | 10.07 - 6.12 | | 338025 L ¹⁾ 338024 R ¹⁾ | | 349084 | | |
| | | | 910147▼ MB1901 910022 SM5668 | | | 910179 SM5669 | | |

1) →7.10
Exc. 1.6 CRDi (94 kW)

i30 II

| | | | | | | | | |
|--|------|---------|---|------------------------|--|----------------------|--|--|
| 1.4, 1.4 LPG, 1.4 MPI 1.6, 1.6 GDI (99 kW), 1.6 T-GDI 1.4 CRDi, 1.6 CRDi | (GD) | 11.11 - | | 3340163 L 3340162 R | | 349084 | | |
| | | | 910284 ¹⁾ SM1044 910287 ¹⁾ | | | SM5669 ²⁾ | | |

1)

| Stroke | Fuel | kW | Date From | Date To | KYB |
|--------|--------|-----------------|-----------|---------|--------|
| 1.4 | Petrol | 73 | 12.11 | 12.15 | 910284 |
| | | 74 | 12.14 | 12.16 | 910287 |
| | Diesel | 66 | 12.11 | 12.16 | 910284 |
| 1.6 | Petrol | 88, 95, 99, 137 | 12.11 | - | 910284 |
| | | 96 | 6.14 | - | 910287 |
| | Diesel | 81, 94 | 12.11 | 12.16 | 910284 |
| | | 100 | 11.11 | 12.16 | 910287 |

2) →12.14

i30 CW II

| | | | | | | | | |
|--|------|--------|---|------------------------|--|----------------------|--|--|
| | (GD) | 6.12 - | | 3340163 L 3340162 R | | 349084 | | |
| | | | 910284 ¹⁾ SM1044 910287 ¹⁾ | | | SM5669 ²⁾ | | |

1)

| Stroke | Fuel | kW | Date From | Date To | KYB |
|--------|--------|------------|-----------|---------|--------|
| 1.4 | Petrol | 73 | 6.12 | 12.15 | 910284 |
| | | 74 | 1.15 | - | 910287 |
| | Diesel | 66 | 6.12 | - | 910284 |
| 1.6 | Petrol | 88, 95, 99 | 6.12 | - | 910284 |
| | | 81, 94 | 6.12 | - | 910284 |
| | Diesel | 100 | 1.15 | - | 910287 |

2) →12.14

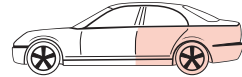
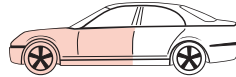

| Hyundai | MODEL FAHRZEUG MODELE | YEAR JAHR ANNEE | FRONT/VORNE/AVANT | | | REAR/HINTEN/ARRIERE | | |
|---------|-----------------------------|-----------------------|-----------------------------|-----------------------------|--------------------------------|-----------------------------|-----------------------------|--------------------------------|
| | | | PREMIUM Twin-tube Oil | EXCEL-G Twin-tube Gas | GAS-A-JUST Mono-tube Gas | PREMIUM Twin-tube Oil | EXCEL-G Twin-tube Gas | GAS-A-JUST Mono-tube Gas |

Hyundai (KO)

i30 Coupé

| | | | | | | | | |
|--|-------------------|--|------------------------|--|--|--------------------------|--|--------|
| 1.4, 1.6 GDI, 1.6 T-GDI, 1.6 MPI 1.4 CRDi, 1.6 CRDi Incl. Sport sus. | 5.13 - 10.13 - | | 3340163 L 3340162 R | | | 349084 | | ⊥ ⊗ |
| | | ☹☹☹ 910284 ¹⁾ ☹☹☹ 910287 ¹⁾ | | | | ☹☹☹ SM5669 ²⁾ | | |
| 1.4 CRDi, 1.6 CRDi (94 kW) ⊕ ⊗ ⊖ Incl. Sport sus. | 5.13 - 9.13 | | 3340163 L 3340162 R | | | 349084 | | ⊥ ⊗ |
| | | ☹☹☹ 910284 ¹⁾ ☹☹☹ 910287 ¹⁾ | | | | ☹☹☹ SM5669 ²⁾ | | |

| 1) | Car application | Date From | Date To | KYB |
|---------------|-----------------|-----------|---------|--------|
| ⚡ exc 1.6 GDI | 1.6 GDI | 5.13 | 9.13 | 910284 |
| | | 10.13 | - | 910287 |
| | 1.6 GDI | 5.13 | - | 910287 |

2) →12.14

ix35

| | | | | | | | | |
|---|-------------|---------------------------------------|----------------------|--|--|-------------------------------------|--|--------|
| <u>2WD</u> (LM, EL, ELH) 1.6, 2.0 (120 kW, 122 kW) 2.0 CVVT (110 kW, = G4KD) 1.7 CRDi, 2.0 CRDi (100 kW, 135 kW) Exc. <u>RUS</u> | 8.09 - | | 339403 L 339402 R | | | 349244 | | ⊥ ⊗ |
| | | ☹☹☹ 910250 ☹☹☹ SM1005 ¹⁾²⁾ | | | | ☹☹☹ 910293 ³⁾ ☹☹☹ SM5850 | | |
| <u>2WD</u> (LM, EL, ELH) 2.0 (113 kW) 2.0 CVVT (110 kW, = G4NA), 2.0 GDi Incl. Sport sus. | 8.13 - | | 339403 L 339402 R | | | 349243 | | ⊥ ⊗ |
| | | ☹☹☹ 910250 ☹☹☹ SM1005 ¹⁾²⁾ | | | | ☹☹☹ 910293 ³⁾ ☹☹☹ SM5850 | | |
| <u>2WD</u> (LM, EL, ELH) 2.0 CRDi (100 kW, 135 kW) ⊕ <u>RUS</u> | 1.10 - | | 339403 L 339402 R | | | 349243 | | ⊥ ⊗ |
| | | ☹☹☹ 910250 ☹☹☹ SM1005 ¹⁾²⁾ | | | | ☹☹☹ SM5850 | | |
| <u>4WD</u> (LM, EL, ELH) 2.0 (113 kW, 120 kW) 2.0 CVVT (110 kW), 2.0 GDi 2.0 CRDi (110 kW, 135 kW) Incl. Sport sus., <u>RUS</u> | 8.09 - | | 339403 L 339402 R | | | 349189 | | ⊥ ⊕ |
| | | ☹☹☹ 910250 ☹☹☹ SM1005 ¹⁾²⁾ | | | | ☹☹☹ 910293 ³⁾ ☹☹☹ SM5850 | | |
| <u>4WD</u> (LM, EL, ELH) 2.0 (116 kW) Incl. Sport sus. | 9.14 - 6.15 | | 339403 L 339402 R | | | 349243 | | ⊥ ⊗ |
| | | ☹☹☹ 910250 ☹☹☹ SM1005 ¹⁾²⁾ | | | | ☹☹☹ SM5850 | | |

ix35

| | | | | | | | | |
|---|-------------|---------------------------------------|----------------------|--|--|------------|--|--------|
| <u>2WD</u> (LM, EL, ELH) 2.0 (120 kW, 122 kW) 2.0 CVVT (110 kW, = G4KD) 2.0 CRDi (100 kW, 135 kW) Incl. Sport sus. | 8.09 - 7.10 | | 339403 L 339402 R | | | 349243 | | ⊥ ⊗ |
| | | ☹☹☹ 910250 ☹☹☹ SM1005 ¹⁾²⁾ | | | | ☹☹☹ SM5850 | | |
| <u>2WD</u> (LM, EL, ELH) 1.6, 1.7 CRDi, 2.0 (120 kW, 122 kW) 2.0 CVVT (110 kW, = G4KD) 2.0 CRDi (100 kW, 135 kW) | 8.10 - | | 339403 L 339402 R | | | 349244 | | ⊥ ⊗ |
| | | ☹☹☹ 910250 ☹☹☹ SM1005 ¹⁾²⁾ | | | | ☹☹☹ SM5850 | | |
| <u>4WD</u> (LM, EL, ELH) 2.0 (120 kW) 2.0 CVVT (110 kW, = G4KD) | 8.09 - 7.10 | | 339403 L 339402 R | | | 349187 | | ⊥ ⊕ |
| | | ☹☹☹ 910250 ☹☹☹ SM1005 ¹⁾²⁾ | | | | ☹☹☹ SM5850 | | |



| MODEL FAHRZEUG MODELE | YEAR JAHR ANNEE | FRONT/VORNE/AVANT | | | | REAR/HINTEN/ARRIERE | | | |
|-----------------------------|-----------------------|-----------------------------|-----------------------------|--------------------------------|--|-----------------------------|-----------------------------|--------------------------------|--|
| | | PREMIUM Twin-tube Oil | EXCEL-G Twin-tube Gas | GAS-A-JUST Mono-tube Gas | | PREMIUM Twin-tube Oil | EXCEL-G Twin-tube Gas | GAS-A-JUST Mono-tube Gas | |

Hyundai (KO)

ix35

| | | | | | |
|---|---------------------------------|----------------------|--|--------|--|
| (4WD) (LM, EL, ELH) 2.0 (120 kW) 2.0 CVVT (110 kW, = G4KD) 2.0 CRDi (100 kW, 135 kW) Incl. Sport sus. | 8.10 - 8.10 - 7.13 1.10 - | 339403 L 339402 R | | 349189 | |
| | | | | | |

ix35

| | | | | | |
|--|--------------|----------------------|--|--------|--|
| (2WD) (LM, EL, ELH) 2.0 (120 kW, 122 kW) 2.0 CVVT (110 kW, = G4KD) 2.0 CRDi (100 kW, 135 kW) Incl. Sport sus. | 8.09 - | 339403 L 339402 R | | 349243 | |
| | | | | | |
| (2WD) (LM, EL, ELH) 2.0 CVVT (110 kW, = G4NA) Exc. Sport sus. | 8.13 - 12.15 | 339403 L 339402 R | | 349243 | |
| | | | | | |
| (2WD) (LM, EL, ELH) 2.0 CVVT (110 kW, = G4NA) ⊕ Sport sus. | 8.13 - 12.15 | 339403 L 339402 R | | 349187 | |
| | | | | | |
| (4WD) (LM, EL, ELH) 2.0 (113 kW, 120 kW), 2.0 CVVT (110 kW) 2.4 (129 kW) 2.0 CRDi (100 kW, 135 kW) Exc. Sport sus. | 8.09 - | 339403 L 339402 R | | 349189 | |
| | | | | | |
| (4WD) (LM, EL, ELH) 2.0 (116 kW) Exc. Sport sus. | 8.13 - 12.15 | 339403 L 339402 R | | 349243 | |
| | | | | | |
| (4WD) (LM, EL, ELH) 2.0 (kW : 113, 116, 120), 2.0 CVVT (110 kW) 2.4 (129 kW) 2.0 CRDi (100 kW, 135 kW) ⊕ Sport sus. | 8.09 - | 339403 L 339402 R | | 349187 | |
| | | | | | |

1) Exc.

| | | | | |
|--------------------|--------|---------------------|--|--------|
| 2.0 CVVT | 99 kW | (4WD) | | |
| 2.0 CVVT | 110 kW | (2WD), (4WD) | | → 5.10 |
| 2.0 CVVT | 120 kW | (2WD), (4WD) | | → 5.10 |
| 2.0 CVVT | 122 kW | (2WD) | | → 5.10 |
| 2.0 CRDi VGT | 135 kW | (2WD) | | → 5.10 |
| 2.0 CRDi | 100 kW | (2WD) | | → 5.10 |
| 2.0 CRDi, CRDi VGT | 100 kW | (4WD) | | → 5.10 |
| 2.0 CRDi VGT | 135 kW | (4WD) | | → 5.10 |

2)

| | | | |
|--------|---|--|-------------|
| SM1005 | = | | O.E. |
| | | | All |
| | | | 54625-3Q000 |
| | | | 54625-2T000 |
| | | | 54625-3R000 |
| ≠ | | | 54625-2S000 |

3) ⊕ 1.6, 2.0 (113 kW),
 2.0 CVVT (110 kW, = G4NA),
 2.0 GDi, 1.7 CRDi
 10.11 →
 Exc. Sport sus.

i40

| | | | | | |
|---------------------------------------|------|-------------|------------------------|--|--------|
| 1.6 GDi ⊕ / | (VF) | 3.12 - | 3340137 L 3340136 R | | 349189 |
| | | | | | |
| 1.6 GDi ⊕ / \, Exc. Sport sus. | (VF) | 3.12 - 1.15 | 3340137 L 3340136 R | | 349243 |
| | | | | | |





| Hyundai | MODEL FAHRZEUG MODELE | YEAR JAHR ANNEE | FRONT/VORNE/AVANT | | | | REAR/HINTEN/ARRIERE | | | |
|--|-----------------------------|----------------------------|-----------------------------|-----------------------------|--------------------------------|--|-----------------------------|-----------------------------|--------------------------------|--|
| | | | PREMIUM Twin-tube Oil | EXCEL-G Twin-tube Gas | GAS-A-JUST Mono-tube Gas | | PREMIUM Twin-tube Oil | EXCEL-G Twin-tube Gas | GAS-A-JUST Mono-tube Gas | |
| Hyundai (KO) | | | | | | | | | | |
| i40 | | | | | | | | | | |
| 1.6 GDi ⊕ / ⊗ \, Sport sus. | (VF) | 3.12 - 1.15 | | 3340137 L ◊ 3340136 R ◊ | | | 349243 | | | |
| | | | 910250 | SM5792 | | | | | | |
| 1.6 GDi ⊕ / ⊗ \ | (VF) | 6.15 - | | 3340137 L ◊ 3340136 R ◊ | | | | | | |
| | | | 910250 | SM5792 | | | | | | |
| 2.0 CVVT, 2.0 GDi 1.7 CRDi (85 kW, 100 kW) Incl. Sport sus. | (VF) | 3.12 - 1.15 | | 3340137 L ◊ 3340136 R ◊ | | | 349243 | | | |
| | | | 910250 | SM5792 | | | | | | |
| 2.0 CVVT, 2.0 GDi | (VF) | 7.16 - | | 3340137 L ◊ 3340136 R ◊ | | | | | | |
| | | | 910250 | SM5792 | | | | | | |
| i40 CW | | | | | | | | | | |
| 1.6 GDi, 2.0 CVVT, 2.0 GDi 1.7 CRDi (85 kW, 100 kW) Exc. Sport sus., | (VF) | 7.11 - 12.14 | | 3340137 L ◊ 3340136 R ◊ | | | 349243 | | | |
| | | | 910250 | SM5792 | | | | | | |
| 1.6 GDi ⊕ Sport sus. Exc. | (VF) | 7.11 - 12.12 | | 3340137 L ◊ 3340136 R ◊ | | | 349243 | | | |
| | | | 910250 | SM5792 | | | | | | |
| 2.0 CVVT, 2.0 GDi 1.7 CRDi (85 kW, 100 kW) ⊕ Sport sus. Exc. | (VF) | 7.11 - 1.13 7.11 - 2.13 | | 3340137 L ◊ 3340136 R ◊ | | | | | | |
| | | | 910250 | SM5792 | | | | | | |
| ix55 / Veracruz | | | | | | | | | | |
| ix55 Veracruz | | 8.07 - | | | | | | | | |
| | | | | SM5539 | | | | | | |
| Kona | | | | | | | | | | |
| 1.0 T-GDi, 1.6 T-GDi (130 kW) 1.6 CRDi, 1.6 CRDi e-VGT (= D4FE) Exc. Hybrid | (OS_) | 7.17 - | | | | | 3430072 | | | |
| | | | | | | | | | | |
| EV (100 kW) EV (150 kW) | (OS_) | 4.18 - 5.18 - | | | | | 3440114 | | | |
| | | | | | | | | | | |
| 1.6 T-GDi (130 kW) 1.6 CRDi e-VGT (= D4FE) Exc. Hybrid | (OS_) | 6.17 - | | | | | 3440114 | | | |
| | | | | | | | | | | |
| Lantra | | | | | | | | | | |
| Incl. ABS | (J1) | 12.90 - 95 | 634050 | 334088 ▼ | | | 441091 | 341147 | | |
| | | | | SM5063 | | | | SM5091 | | |



| MODEL FAHRZEUG MODELE | YEAR JAHR ANNEE | FRONT/VORNE/AVANT | | | REAR/HINTEN/ARRIERE |
|---|-----------------------|---|---|--------------------------------|--|
| | | PREMIUM Twin-tube Oil | EXCEL-G Twin-tube Gas | GAS-A-JUST Mono-tube Gas | |
| Hyundai (KO) | | | | | |
| Lantra | | | | | |
| ALL Incl. ABS | (J2) 95 - 9.00 | 633180 L ▼ 633179 R ▼ ☹☹☹☹ 910061 | 333206 L 333205 R ☹☹☹☹ SM5193 | | 633182 L ▼ 633181 R ▼ ☹☹☹☹ 910077 ☹☹☹☹ SM5239 L ☹☹☹☹ SM5240 R |
| | 9.00 - 06 | | ☹☹☹☹ SM5193 | | ☹☹☹☹ SM5239 L ☹☹☹☹ SM5240 R |
| Matrix | | | | | |
| | (FC) 6.01 - 8.10 | | 333367 L 333366 R ☹☹☹☹ 910214 ☹☹☹☹ SM5193 | | 333505 L ▼ 333504 R ▼ 3330057 L 3330056 R ☹☹☹☹ 910215 ☹☹☹☹ SM5239 L ☹☹☹☹ SM5240 R |
| Pony, Excel | | | | | |
| Pony 1200, 1400 | 77 - 84 | | 365039 | | 443194 343153 |
| Pony Excel 1300, 1500 KMHL ... | 85 - 7.89 | | | | |
| Pony 1300, 1500 Excel 1500 KMHU ..., KMHV ... | (X2) 8.89 - 94 | 633150 | 333156 ☹☹☹☹ 916902 | | 443269 343183 |
| Santa Fe I | | | | | |
| ALL 2WD 4WD | (SM) 11.00 - 3.06 | | 339749 L 339748 R ☹☹☹☹ 910023 ☹☹☹☹ SM5295 | | 344314 ☹☹☹☹ 910109 ☹☹☹☹ SM5296 |
| Santa Fe II | | | | | |
| 2WD 4WD 2.0 CRDi (85 kW, 135 kW) 2.2 CRDi (102 kW, 114 kW), 2.2 CRDi GLS 2.7, 2.7 V6 GLS Exc. | (CM) 3.06 - 12.12 | | 339751 L 339750 R ☹☹☹☹ 910076 ¹⁾ ☹☹☹☹ SM5539 ²⁾ | | 3440028 |
| 2WD 4WD 2.0 CRDi (110 kW) 2.2 CRDi (145 kW, 147 kW) 2.4, 3.5, 3.5 CVT Exc. | (CM) 1.09 - 5.13 | | ☹☹☹☹ 910076 ¹⁾ | | 3440028 |
| 1) →8.09 2) ⊕ 2.7 (125 kW) 4WD, 2.7 V6 GLS 4WD, 2.2 CRDi (102 kW, 114 kW) 2WD 4WD, 2.2 CRDi GLS (110 kW) 2WD 4WD | | | | | |
| Santa Fe III | | | | | |
| 2WD 2.4, 2.4 CVT (129 kW) 2.0 CRDi (110 kW), 2.2 CRDi (145 kW) Exc. H/D, | (DM) 9.12 - | | 3340195 L 3340194 R | | 3410081 |



| Hyundai | MODEL FAHRZEUG MODELE | YEAR JAHR ANNEE | FRONT/VORNE/AVANT | | | | REAR/HINTEN/ARRIERE | | | |
|---------------------------------------|--|-----------------------|-----------------------------|--|--------------------------------|--|-----------------------------|-----------------------------|--------------------------------|----------|
| | | | PREMIUM Twin-tube Oil | EXCEL-G Twin-tube Gas | GAS-A-JUST Mono-tube Gas | | PREMIUM Twin-tube Oil | EXCEL-G Twin-tube Gas | GAS-A-JUST Mono-tube Gas | |
| Hyundai (KO) | | | | | | | | | | |
| Santa Fe III | | | | | | | | | | |
| | (DM) 2.4 GDi 2.0 CRDi (136 kW), 2.2 CRDi (147 kW) | 5.15 - | | 3340195 L 3340194 R | | | | | | |
| | (DM) 2.2 CRDi (145 kW) ⊕ H/D Exc. | 9.12 - 12.15 | | 3340195 L 3340194 R | | | | 3410081 | | |
| | (DM) 2.4, 2.4 CVT, 2.4 GDi (138 kW) 2.0 CRDi, 2.2 CRDi (145 kW, 147 kW) Incl. H/D Exc. | 9.12 - | | 3340195 L 3340194 R | | | | 3440072 | | |
| Grand Santa Fe | | | | | | | | | | |
| | 3.0 GDi (183 kW), 3.3 (183 kW, 199 kW) 2.2 CRDi (145 kW, 147 kW) | 6.13 - | | 3340195 L 3340194 R | | | | 3440072 | | |
| Santamo | | | | | | | | | | |
| | | 7.98 - | 634042 | 334070 SM5195 | | | 443265 | 343262 ▼ | | |
| | | 7.98 - | 634043 ▼ | 334071 SM5195 | | | 443265 | 343262 ▼ | | |
| S-Coupé (KMHU..., KMHV...) | | | | | | | | | | |
| | (SLC) Exc. GT Turbo | 3.90 - 96 | 633150 916902 | 333156 SM5060 ▼ | | | 443269 | 343183 | | |
| | GT Turbo | (SLC) 90 - 96 | | 333156 916902 SM5060 ▼ | | | | 343183 | | |
| Solaris IV | | | | | | | | | | |
| | (RB) 1.4, 1.6 | 11.10 - 1.12 | | 338109 L 338108 R SM5818 ¹⁾ | | | | | | |
| | (RB) 1.4, 1.6 | 9.11 - | | SM5818 ¹⁾ | | | | 349098 | | |
| 1) → 02.12 | | | | | | | | | | |
| Solaris V | | | | | | | | | | |
| | 1.4, 1.6 (90 kW) | 1.17 - | | | | | | 348007 | | |
| Sonata / Sonica | | | | | | | | | | |
| | Sonata II KMHAF, KMHBF Incl. ABS | (Y2) 88 - 93 | 634063 ▼ | 334020 ▼ SM5195 | | | | 341154 ▼ | | SM5294 ▼ |

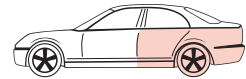

| MODEL FAHRZEUG MODELE | YEAR JAHR ANNEE | FRONT/VORNE/AVANT | | | | REAR/HINTEN/ARRIERE | | | |
|--|-----------------------|-----------------------------|-----------------------------|--------------------------------|--|-----------------------------|-----------------------------|--------------------------------|--|
| | | PREMIUM Twin-tube Oil | EXCEL-G Twin-tube Gas | GAS-A-JUST Mono-tube Gas | | PREMIUM Twin-tube Oil | EXCEL-G Twin-tube Gas | GAS-A-JUST Mono-tube Gas | |
| Hyundai (KO) | | | | | | | | | |
| Sonata / Sonica | | | | | | | | | |
| Sonata III KMHCF, KMHDF Incl. ABS | (Y3) 7.93 - 99 | | 334141 | | | | 341192 | | |
| | | | | SM5194 | | | SM5294▼ | | |
| Sonata IV Incl. ABS | (EF) 99 - 3.00 | | 341280 | | | | 341427 ¹⁾ ▼ | | |
| | | | | | | | SM5200▼ | | |
| Sonata IV Incl. ABS | (EF) 4.00 - 11.04 | | 341280 | | | | 341281 | | |
| | | | | | | | 910173 SM5091 | | |
| Sonata V | (NF) 1.05 - | | 341460 | | | | 349038 | | |
| | | | | SM5618 | | | 910320 ²⁾ SM5617 | | |
| Sonata VI 2.0 (110 kW), 2.4 (131 kW) Exc. Hybrid, Sport sus. | (YF) 6.09 - 5.11 | | 3340220 L◇ 3340219 R◇ | | | | 349243 | | |
| | | | | SM5792 | | | | | |
| Sonata VI 2.0 (110 kW, 120 kW), 2.4 (131 kW) Exc. Hybrid, Sport sus. | (YF) 6.11 - 12.15 | | | | | | 349243 | | |
| | | | | SM5792 | | | | | |
| Sonata VI 2.0 (110 kW), 2.4 (131 kW) ⊕ Sport sus. Exc. Hybrid | (YF) 6.09 - 12.10 | | 3340220 L◇ 3340219 R◇ | | | | 349243 | | |
| | | | | SM5792 | | | | | |
| Sonata VI 2.0 (110 kW, 120 kW), 2.4 (131 kW) ⊕ Sport sus. Exc. Hybrid | (YF) 1.11 - 12.15 | | | | | | 349243 | | |
| | | | | SM5792 | | | | | |
| 1) 292 mm 2) 12.05 → | | | | | | | | | |
| Stellar | | | | | | | | | |
| | 83 - 12.86 | 443016 | | | | | 443017 | | |
| | 87 - 12.89 | | | | | | 443017 | | |
| Terracan | | | | | | | | | |
| | (HP) 5.01 - 12.06 | | 344453 | 554338▼ | | | 344454 | | |
| Trajjet | | | | | | | | | |
| Incl. ABS | (FO) 3.00 - 7.08 | | 334238 L 334237 R | | | | 344297 | | |
| | | | | SM5295 | | | | | |



| MODEL FAHRZEUG MODELE | YEAR JAHR ANNEE | FRONT/VORNE/AVANT | | | | REAR/HINTEN/ARRIERE | | | |
|--|-----------------------|-----------------------------|-----------------------------|--------------------------------|--|-----------------------------|--|--------------------------------|--|
| | | PREMIUM Twin-tube Oil | EXCEL-G Twin-tube Gas | GAS-A-JUST Mono-tube Gas | | PREMIUM Twin-tube Oil | EXCEL-G Twin-tube Gas | GAS-A-JUST Mono-tube Gas | |
| Hyundai (KO) | | | | | | | | | |
| Tucson | | | | | | | | | |
| | (JM) | 7.04 - 3.10 | | 339743 L 339742 R | | | 334505 L ▼ 334504 R ▼ 339747 L 339746 R | | |
| | | | | 910078 SM5295 | | | 910064 SM5239 L SM5240 R | | |
| 2.0, 2.0 CVVT 1.6 CRDi, 1.6 CRDi Hybrid 48v 1.6 GDi, 1.6 T-GDi (130 kW), 1.7 CRDi 2.0 CRDi (100 kW, 136 kW) Incl. Sport sus. Exc. 2.0 (114 kW) , 1.6 CRDi (85 kW) | (TL, TLE) | 6.15 - | | | | | 3440062 | | |
| | | | | | | | 910318 ¹⁾ | | |
| | (TL, TLE) | 10.18 - | | | | | 3440122 | | |
| | | | | | | | 910318 ¹⁾ | | |
| 1.6 CRDi Hybrid 48v (NX4E, NX4A) 1.6 T-GDi Hybrid 48v (110 kW) Exc. HTRAC, | | 11.20 - | | | | | 3440122 | | |
| 1) | | | | | | | | | |
| Veloster | | | | | | | | | |
| 1.6 (95 kW), 1.6 GDi | (FS) | 3.11 - 9.11 | | 3330074 L ▼ 3330073 R ▼ | | | | 554384 | |
| | | | | SM1050 ▼ | | | | | |
| 1.6 (95 kW), 1.6 GDi 1.6 MPi, 1.6 T-GDi | (FS) | 10.11 - | | 3330094 L 3330093 R | | | | 554384 | |
| | | | | SM1050 ▼ | | | | | |
| XG | | | | | | | | | |
| 2.5 i, 3.0 i Incl. ABS | (XG) | 99 - 5.00 | | 341280 | | | 341427 ¹⁾ ▼ | | |
| | | | | | | | | | |
| 2.5 i, 3.0 i, 3.5 i Incl. ABS | (XG) | 6.00 - 12.05 | | 341280 | | | 341427 ¹⁾ ▼ | SM5091 | |
| | | | | | | | | | |
| 2.5 i, 3.0 i, 3.5 i Incl. ABS | (XG) | 6.00 - 12.05 | | 341280 | | | 341281 ²⁾ | SM5091 | |
| | | | | | | | | | |
| 1) 292 mm 2) 143 mm | | | | | | | | | |
| Isuzu (J) | | | | | | | | | |
| D-MAX | | | | | | | | | |
| 2.5 D / DiTD 3.0 D / DiTD | | 6.03 - | | 344420 | | | 344422 | | |



| MODEL FAHRZEUG MODELE | YEAR JAHR ANNEE | FRONT/VORNE/AVANT | | | | REAR/HINTEN/ARRIERE | | | |
|--|---------------------------------|-----------------------------|-----------------------------|--------------------------------|--|-----------------------------|-----------------------------|--------------------------------|--|
| | | PREMIUM Twin-tube Oil | EXCEL-G Twin-tube Gas | GAS-A-JUST Mono-tube Gas | | PREMIUM Twin-tube Oil | EXCEL-G Twin-tube Gas | GAS-A-JUST Mono-tube Gas | |
| Isuzu (J) | | | | | | | | | |
| D-MAX | | | | | | | | | |
| 2.5 D, 3.0 D (High Ride sus.) | 6.03 - | | 341355 | | | | 344421 | | |
| 2.5 D, 3.0 D (High Ride sus.) | 6.03 - | | 344420 | | | | 344422 | | |
| D-MAX II | | | | | | | | | |
| 2.5 CRDi (120 kW) (TFR86J) Incl. Exc. Extended cab | 6.12 | | | | | | 349223 | | |
| Elf / Elf 250, 350 | | | | | | | | | |
| TL 10, 30 (Elf 250) TL 20 (Elf 250) | 70- 79 70- 74 | 444028 | 344062▼ | | | 444058 | | | |
| TL 20 (Elf 250) | 75- 79 | 444028 | 344062▼ | | | 444056 | | | |
| TL 40, 50 (Elf 250) | 70- 79 | 444028 | 344062▼ | | | 444057 | | | |
| KS series (Elf 350) | 70- 79 | 445016 | | | | 444058 | | | |
| Fargo / Midi / Seta | | | | | | | | | |
| (WFR series) = | 80- 88 | 444065 | | | | 444040 | | | |
| (9800 series) = | 88 - | 444065 | | | | 444040 | | | |
| (9400 series) = | 88 - | | | | | 444025 | | | |
| Gemini | | | | | | | | | |
| 1300, 1500 (JT 150/600) Exc. Diesel, Turbo-Diesel, Turbo | 3.85 - | 632043 L▼ 632042 R▼ | | | | | | 552022▼ | |
| 1500 Diesel (JT 150/600) 1500 Turbo-Diesel 1500 Turbo | 7.85 - 7.85 - 4.86 - 5.87 | 633066 L▼ 633065 R▼ | | | | | | 552022▼ | |
| Lite Elf / Elf 150 | | | | | | | | | |
| KA 20, 40, 50 | 68 - 8.72 | 444028 | 344062▼ | | | 444023 | 344102 | | |
| KA 41, 51 | 9.72 - | 444028 | | | | 444056 | | | |



| MODEL FAHRZEUG MODELE | YEAR JAHR ANNEE | FRONT/VORNE/AVANT | | | | REAR/HINTEN/ARRIERE | | | |
|--|-----------------------|-----------------------------|-----------------------------|--------------------------------|--|-----------------------------|-----------------------------|--------------------------------|--|
| | | PREMIUM Twin-tube Oil | EXCEL-G Twin-tube Gas | GAS-A-JUST Mono-tube Gas | | PREMIUM Twin-tube Oil | EXCEL-G Twin-tube Gas | GAS-A-JUST Mono-tube Gas | |
| Isuzu (J) | | | | | | | | | |
| Pick-up / Faster / Campo / Brava | | | | | | | | | |
| Faster (KB 20, 30 series) | 2.72 - | 443188 | | 553087 | | 444025 | | | |
| Faster (KBD 2, KBG 2) = | 10.80 - | 443190 | | 553119 | | 443186 | | 553108 | |
| Faster (KBD 4, KBG 4) = | 10.80 - | 443188 | | 553087 | | 443186 | | 553108 | |
| Campo/Brava (TFR Series) | 4.88 - 00 | 443190 ¹⁾ | | 553119 ¹⁾ | | 443295 | | 553230 | |
| Campo/Brava (TFR Series) | 4.88 - 00 | 443342 ²⁾ | | | | 443295 | | 553230 | |
| Campo/Brava (TFS Series) | 4.88 - 96 | 443216 | | 553171 | | 443295 | | 553230 | |
| 1) 443190, 553119 : O.E. = 8970140420 2) 443342 : O.E. = 8944463731, 8944463741 | | | | | | | | | |
| Trooper / Big Horn | | | | | | | | | |
| UBS = | 82 - 10.86 | 443188 | | 553087 | | 443186 | | 553108 | |
| UBS = Exc. | 11.86 - 91 | 444132 | | | | 444083 | | 553204▼ | |
| UBS = Exc. | 92 - 1.98 | | 344279 | | | | 344229 | | |
| UBS = Exc. | 2.98 - | | 344355 | | | | 344229 | | |
| Iveco (I) | | | | | | | | | |
| Daily | | | | | | | | | |
| Daily I 44803 | 1.78 - 12.89 | 444302 | | | | 444306 | | | |
| Daily I 35 - 8 35 - 10 40 - 8 | 1.78 - 12.89 | 444300 | | | | 444306 | | | |
| Daily I 49 - 10 | 1.78 - 12.89 | 444303 | | | | 444306 | | | |
| Daily I 30 - 8 30 - 10 35 - 8 35 - 10 35 - 12 ⊖ H/D 40 - 8 | 1.89 - 4.99 | 444302 | | | | 444305 ¹⁾ | | | |
| 1) Exc. OE = 4854829, 93826663, 93826664 | | | | | | | | | |

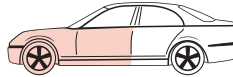

| MODEL FAHRZEUG MODELE | YEAR JAHR ANNEE | FRONT/VORNE/AVANT | | | | REAR/HINTEN/ARRIERE | | | |
|---|--|-----------------------------|-----------------------------|--------------------------------|--|-----------------------------|-----------------------------|--------------------------------|--|
| | | PREMIUM Twin-tube Oil | EXCEL-G Twin-tube Gas | GAS-A-JUST Mono-tube Gas | | PREMIUM Twin-tube Oil | EXCEL-G Twin-tube Gas | GAS-A-JUST Mono-tube Gas | |
| Iveco (I) | | | | | | | | | |
| Daily | | | | | | | | | |
| Daily I (2WD) 35 - 12 45 - 10 49 - 10 49 - 12 | 1.89 - 4.99 | 444303 | | | | 444305 ¹⁾ | | | |
| 1) Exc. OE = 4854829, 93826663, 93826664 | | | | | | | | | |
| Jaguar (GB) | | | | | | | | | |
| S-Type | | | | | | | | | |
| (CCX) → M45254 Exc. | 1.99 - 10.07 | | | 551611 | | | | 551612 | |
| X-Type | | | | | | | | | |
| | 6.01 - 12.09 | | 334690 | | | | | | |
| XJ Type | | | | | | | | | |
| XJ 6 Daimler Sovereign XJ 12, Sovereign V 12 Daimler Double Six XJS, XJS V 12 | 68 - 86 69 - 84 72 - 2.93 72 - 2.93 75 - | | | 553074 | | | | 551022 (x2) | |
| XJ Type (XJ 40, XJ 81 Series) | | | | | | | | | |
| XJ 6, Sovereign, Daimler (XJ 40) XJ 12, Daimler Double Six (XJ 81) Exc. | 10.86 - 9.94 2.93 - 9.94 | | | 553179 | | | | 551057 | |
| XJ Type (X300 Series) | | | | | | | | | |
| XJ 6, XJ 12 Daimler Six, Daimler Double Six Exc. Sport, | 10.94 - 97 | | | 553208 | | | | 555007 | |
| XJ Type (X308 Series) | | | | | | | | | |
| XJ 8, Daimler XJ 8 Incl. Sport sus Exc. | 10.97 - | | | 554114 | | | | 555008 | |
| XJR Incl. Sport sus. Exc. | 10.97 - | | | | | | | 555008 | |
| XK8 (QEV) , XKR (QDV) | | | | | | | | | |
| XK8 Exc. XKR Exc. | 10.96 - 5.98 - | | | | | | | 555010 | |



Jeep

| MODEL FAHRZEUG MODELE | YEAR JAHR ANNEE | FRONT/VORNE/AVANT | | | REAR/HINTEN/ARRIERE | |
|--|-----------------------|-----------------------------|-----------------------------|--------------------------------|---------------------|-----------------------------|
| | | PREMIUM Twin-tube Oil | EXCEL-G Twin-tube Gas | GAS-A-JUST Mono-tube Gas | | PREMIUM Twin-tube Oil |
| Jeep (US) | | | | | | |
| Cherokee, Wagoneer, Grand Cherokee, Grand Wagoneer | | | | | | |
| «Cherokee, Wagoneer ☞ = 101» = 2,565 mm» (XJ) | 84 - 90 | | 344392 | | 344418 | |
| «Cherokee, Wagoneer ☞ = 101» = 2,565 mm» (XJ) | 91 - 01 | | 344393 | | 344418 | |
| Cherokee (KJ) | 01 - | | 331017 | | 344404 | |
| | | | | SM5387 L SM5386 R | | |
| Cherokee, Grand Cherokee | | | | | | |
| Grand Cherokee I Grand Wagoneer Exc. Up-Country sus. (☞) | (ZJ) 92 - 98 | | 344393 | | 344394 | |
| Grand Cherokee II (WJ/G) | 99 - 03 | | 344341 | 554169▼ | 344342 | |
| Grand Cherokee III, Commander 3.0 CRD, 3.7 V6, 4.7 V8, 5.7 V8 (WH, XK) | 05 - 12.10 | | 341603 | | 344496 | |
| | | | | SM1026 | | |
| Cherokee ☞ ALL 2WD 4WD (KL) | 11.13 - | | | | | |
| | | | | SM5813 L SM5814 R | | |
| Grand Cherokee IV 3.0 CRD V6 (4WD), 3.6 V6 (209 kW) (2WD), 3.6 V6 (210 kW) (4WD), 3.6 V6 FlexFuel (210 kW) (4WD), 3.6 VVT (4WD), 5.7 V8 (259 kW) (4WD) Exc. Sport sus., ☞, ⚡ Exc. ☞, Auto Entry/Exit sus., Tuned (WK, WK2) | 11.10 - | | | | 3440055 | |
| Grand Cherokee IV 3.0 CRD V6 (4WD), 3.6 V6 (209 kW) (2WD), 3.6 V6 (210 kW) (4WD), 3.6 VVT (4WD), 5.7 V8 (259 kW) (4WD) ☞ ☞ Incl. ☞ Exc. Sport sus., ⚡ Exc. Auto Entry/Exit sus., Tuned (WK, WK2) | 11.10 - | | | | 3440055 | |
| Grand Cherokee IV 3.0 CRD V6 (4WD), 3.6 V6 (209 kW) (2WD), 3.6 V6 (4WD), 3.6 VVT (4WD), 5.7 V8 (259 kW) (4WD) ☞ Sport sus., ☞ Incl. ☞ Exc. ⚡, Auto Entry/Exit sus., Tuned (WK, WK2) | 11.10 - | | | | 3440055 | |
| Compass, Patriot | | | | | | |
| Compass 2.4 (2WD) (4WD) 2.0 CRD (2WD) (4WD) (MK49) | 8.06 - 8.06 - | | | | 341654 | |
| | | | | SM5601 | | |



| MODEL FAHRZEUG MODELE | YEAR JAHR ANNEE | FRONT/VORNE/AVANT | | | | REAR/HINTEN/ARRIERE | | | |
|--|--|-----------------------------|-----------------------------|--------------------------------|--|-----------------------------|-----------------------------|--------------------------------|--|
| | | PREMIUM Twin-tube Oil | EXCEL-G Twin-tube Gas | GAS-A-JUST Mono-tube Gas | | PREMIUM Twin-tube Oil | EXCEL-G Twin-tube Gas | GAS-A-JUST Mono-tube Gas | |
| Jeep (US) | | | | | | | | | |
| Compass, Patriot | | | | | | | | | |
| Patriot (MK74) 2.0 (2WD) (4WD) 2.4 (2WD) (4WD) 2.4 ECO (4WD) 2.0 CRD (2WD) (4WD) | 2.07 - 2.07 - 7.08 - 2.07 - | | | | | | 341654 | | |
| | | | | SM5601 | | | SM5788 | | |
| Compass (MK49) 2.0 (2WD) 2.2 CRD (2WD) (4WD) Patriot (MK74) 2.2 CRD (2WD) (4WD) | 5.11 - 12.10 - 1.11 - | | | | | | | | |
| | | | | SM5601 | | | SM5788 | | |
| Compass (2WD) (4WD) 1.4 MultiAir, 2.0 Multijet II 1.6 CRD, 2.0 CRD | 12.16 - | | | | | | | SM5892 L SM5891 R | |
| Liberty | | | | | | | | | |
| 2.4 (2WD) (4WD) 3.7 (155 kW) (4WD) 2.8 CRDi (4WD) | 9.01 - 9.05 9.01 - 12.09 11.04 - 12.06 | | 331017 | | | | 344404 | 554185 | |
| (KK) | 1.08 - | | | | | | | | |
| | | | | SM5601 | | | | | |
| Renegade | | | | | | | | | |
| (2WD) (BU, B1) 1.0 T-GDi, 1.3 T-GDi (110 kW) 1.4 (100 kW, 103 kW), 1.6 1.6 CRD | 7.14 - | | | | | | 3348079 L 3348078 R | | |
| | | | | | | | SM5892 L SM5891 R | | |
| (4WD) (BU, B1) | 7.14 - | | | | | | | SM5892 L SM5891 R | |
| | | | | | | | | | |
| Wrangler | | | | | | | | | |
| (YJ Series) | 87 - 95 | | 344091 | | | | 344092 | | |
| Wrangler II (TJ) 3.8 (4WD) Wrangler III (JK) 2.8 CRD (4WD), 3.6 V6 (4WD), 3.8 (4WD) | 2.06 - 4.07 - | | 349071 | 555062 | | | 349069 | 555063▼ | |
| | | | | | | | | | |
| Kia (KO) | | | | | | | | | |
| Besta | | | | | | | | | |
| | 10.92 - | 444162 | 344302▼ | | | 443302 | 343320▼ | | |
| | | | | | | | | | |
| Carens | | | | | | | | | |
| Carens I (FC) Incl. ABS | 99 - 7.02 | | 333315 L 333314 R | | | | 333265 L 333264 R | | |
| | | | | | | | | | |



Kia

| MODEL FAHRZEUG MODELE | YEAR JAHR ANNEE | FRONT/VORNE/AVANT | | | | REAR/HINTEN/ARRIERE | | | |
|---|-----------------------|--|-----------------------------|--|--|-----------------------------|-----------------------------|--------------------------------|--|
| | | PREMIUM Twin-tube Oil | EXCEL-G Twin-tube Gas | GAS-A-JUST Mono-tube Gas | | PREMIUM Twin-tube Oil | EXCEL-G Twin-tube Gas | GAS-A-JUST Mono-tube Gas | |
| Kia (KO) | | | | | | | | | |
| Carens | | | | | | | | | |
| Carens II | (UN) | 9.06 - | | 334509 L ▼ 334508 R ▼ 3340084 L 3340083 R | | | 3440021 ¹⁾ | | |
| | | | | | | | | | |
| Carens III 1.6 GDi, 2.0 GDi (122 kW) 2.0 MPI (110 kW) 1.7 CRDi (kW : 85, 100, 104) Exc. Model year 2016 | | 3.13 - 7.16 | | | | | | 5530007 | |
| 1) ABS | | | | | | | | | |
| Carnival / Sedona | | | | | | | | | |
| Carnival I Incl. ABS | (UP) | 99 - 10.01 | | 335043 L 335042 R | | | 344296 | 554145 ▼ | |
| | | | | | | | | | |
| Carnival II Incl. ABS | (GQ) | 10.01 - 5.06 | | 335043 L 335042 R | | | 344296 | 554145 ▼ | |
| | | | | | | | | | |
| Carnival III, Grand Carnival III, Sedona III 2.7 V6, 2.9 CRDi | (VQ) | 9.06 - | | 339310 L 339309 R | | | 349094 | | |
| | | | | | | | | | |
| Carnival III, Grand Carnival III, Sedona III 2.2 CRDi | (VQ) | 1.10 - | | | | | 349094 | | |
| | | | | | | | | | |
| 1) → 6.11 | | | | | | | | | |
| Cee'd (ED) | | | | | | | | | |
| 1.4, 1.4 CVVT, 1.6, 2.0 1.6 LPG 1.6 CRDi 90, 1.6 CRDi 115 2.0 CRDi (100 kW) 2.0 CRDi 140 (103 kW) | (ED) | 12.06 - 12.12 6.07 - 7.09 12.06 - 12.12 6.07 - 6.09 9.07 - 12.12 | | 339258 L 339257 R | | | 349084 | | |
| | | | | | | | | | |
| 1.4 LPG 1.6 CVVT, 1.6 LPG 1.6 CRDi 128, 2.0 CRDi (100 kW) | (ED) | 1.09 - 4.12 8.09 - 12.12 7.09 - 12.12 | | 3340222 L ◊ 3340221 R ◊ | | | 349084 | | |
| | | | | | | | | | |
| Cee'd SW (ED) | | | | | | | | | |
| 1.4 (80 kW), 1.4 CVVT, 1.6, 2.0 1.6 CRDi 90, 1.6 CRDi 115 2.0 CRDi 140 (100 kW) 2.0 CRDi 140 (103 kW) | (ED) | 9.07 - 12.12 9.07 - 12.12 7.07 - 6.09 7.07 - 12.12 | | 339258 L 339257 R | | | 349084 | | |
| | | | | | | | | | |



| MODEL FAHRZEUG MODELE | YEAR JAHR ANNEE | FRONT/VORNE/AVANT | | | | REAR/HINTEN/ARRIERE | | | | | | | | | | | | | | | | | | | | | |
|--|--|---|-----------------------------|--------------------------------|--|---|-----------------------------|--------------------------------|--|-----------------|-----------|---------|-----|---------|------|------|--------|------|---|--------|--------|------|------|--------|------|---|--------|
| | | PREMIUM Twin-tube Oil | EXCEL-G Twin-tube Gas | GAS-A-JUST Mono-tube Gas | | PREMIUM Twin-tube Oil | EXCEL-G Twin-tube Gas | GAS-A-JUST Mono-tube Gas | | | | | | | | | | | | | | | | | | | |
| Kia (KO) | | | | | | | | | | | | | | | | | | | | | | | | | | | |
| Cee'd SW (ED) | | | | | | | | | | | | | | | | | | | | | | | | | | | |
| 1.4 (77 kW), 1.4 LPG, 1.6 CVVT 1.6 LPG, 1.6 CRDi 128 2.0 CRDi 140 (100 kW) | (ED) 2.08 - 9.12 7.09 - 12.12 | | 3340222 L 3340221 R | | | 349084 | | | | | | | | | | | | | | | | | | | | | |
| | | 910148 | MB1901 SM5668 | | | 910179 | SM5669 | | | | | | | | | | | | | | | | | | | | |
| ProCee'd (ED) | | | | | | | | | | | | | | | | | | | | | | | | | | | |
| 1.4 (80 kW), 1.4 CVVT 1.6, 1.6 CVVT (85 kW), 2.0 2.0 LPG 1.6 CRDi 90, 1.6 CRDi 115, 2.0 CRDi 140 | (ED) 2.08 - 9.12 2.08 - 9.12 1.09 - 6.09 2.08 - 9.12 | | 339258 L 339257 R | | | 349084 | | | | | | | | | | | | | | | | | | | | | |
| | | 910148 | MB1901 SM5668 | | | 910179 | SM5669 | | | | | | | | | | | | | | | | | | | | |
| 1.4 (77 kW), 1.6 CVVT (92 kW) 2.0 LPG 1.6 CRDi 128 | (ED) 2.08 - 2.13 7.09 - 12.09 10.10 - 9.12 | | 3340222 L 3340221 R | | | 349084 | | | | | | | | | | | | | | | | | | | | | |
| | | 910148 | MB1901 SM5668 | | | 910179 | SM5669 | | | | | | | | | | | | | | | | | | | | |
| Cee'd (JD) | | | | | | | | | | | | | | | | | | | | | | | | | | | |
| 1.4 CVVT, 1.4 LPG, 1.4 MPI, 1.6 CVVT 1.4 CRDi 90, 1.6 GDI Incl. Sport sus., Special Edition, | (JD) 5.12 - | | 3340163 L 3340162 R | | | 349084 | | | | | | | | | | | | | | | | | | | | | |
| | | 910284 ¹⁾ SM1044 ²⁾ 910287 ¹⁾ | | | | 910179 ³⁾ SM5669 ³⁾ | | | | | | | | | | | | | | | | | | | | | |
| 1.0 T-GDI 1.6 CRDi 110, 1.6 CRDi 128, 1.6 CRDi 136 Incl. Sport sus. Exc. Special Edition, | (JD) 5.12 - | | 3340163 L 3340162 R | | | 349084 | | | | | | | | | | | | | | | | | | | | | |
| | | 910284 ¹⁾ SM1044 ²⁾ 910287 ¹⁾ | | | | 910179 ³⁾ SM5669 ³⁾ | | | | | | | | | | | | | | | | | | | | | |
| 1.0 T-GDI 1.6 CRDi 110, 1.6 CRDi 128, 1.6 CRDi 136 Special Edition, | (JD) 5.12 - | | | | | 349084 | | | | | | | | | | | | | | | | | | | | | |
| | | 910284 ¹⁾ SM1044 ²⁾ 910287 ¹⁾ | | | | 910179 ³⁾ SM5669 ³⁾ | | | | | | | | | | | | | | | | | | | | | |
| 1.6 GT Incl. Sport sus., Special Edition, | (JD) 6.13 - 4.15 | | 3340163 L 3340162 R | | | 349084 | | | | | | | | | | | | | | | | | | | | | |
| | | 910287 ¹⁾ SM1044 ²⁾ 910288 ¹⁾ | | | | 910179 SM5669 | | | | | | | | | | | | | | | | | | | | | |
| 1.6 GT Incl. Sport sus., Special Edition, | (JD) 5.15 - | | | | | 349084 | | | | | | | | | | | | | | | | | | | | | |
| | | 910287 ¹⁾ 910288 ¹⁾ | | | | | | | | | | | | | | | | | | | | | | | | | |
| 1) <table border="1"> <thead> <tr> <th>Car application</th> <th>Date From</th> <th>Date to</th> <th>KYB</th> </tr> </thead> <tbody> <tr> <td rowspan="2"> exc. GT</td> <td>5.12</td> <td>4.14</td> <td>910284</td> </tr> <tr> <td>5.14</td> <td>-</td> <td>910287</td> </tr> <tr> <td rowspan="2">1.6 GT</td> <td>6.13</td> <td>4.15</td> <td>910288</td> </tr> <tr> <td>5.15</td> <td>-</td> <td>910287</td> </tr> </tbody> </table> 2) Exc. Special Edition 3) → 4.15 | | | | | | | | | | Car application | Date From | Date to | KYB | exc. GT | 5.12 | 4.14 | 910284 | 5.14 | - | 910287 | 1.6 GT | 6.13 | 4.15 | 910288 | 5.15 | - | 910287 |
| Car application | Date From | Date to | KYB | | | | | | | | | | | | | | | | | | | | | | | | |
| exc. GT | 5.12 | 4.14 | 910284 | | | | | | | | | | | | | | | | | | | | | | | | |
| | 5.14 | - | 910287 | | | | | | | | | | | | | | | | | | | | | | | | |
| 1.6 GT | 6.13 | 4.15 | 910288 | | | | | | | | | | | | | | | | | | | | | | | | |
| | 5.15 | - | 910287 | | | | | | | | | | | | | | | | | | | | | | | | |



Kia

| MODEL FAHRZEUG MODELE | YEAR JAHR ANNEE | FRONT/VORNE/AVANT | | | REAR/HINTEN/ARRIERE | | |
|-----------------------------|-----------------------|-----------------------------|-----------------------------|--------------------------------|-----------------------------|-----------------------------|--------------------------------|
| | | PREMIUM Twin-tube Oil | EXCEL-G Twin-tube Gas | GAS-A-JUST Mono-tube Gas | PREMIUM Twin-tube Oil | EXCEL-G Twin-tube Gas | GAS-A-JUST Mono-tube Gas |

Kia (KO)

Cee'd Sportswagon (JD)

| | | | | | | | | |
|-------|------|--------|---|------------------------|--|---|--------|--|
| Incl. | (JD) | 9.12 - | | 3340163 L 3340162 R | | | 349084 | |
| | | | 910284 ¹⁾ SM1044 910287 ¹⁾ | | | 910179 ²⁾ SM5669 ²⁾ | | |

1)

| Stroke | Fuel | kW | Date From | Date To | KYB |
|--------|--------|-------------|-----------|---------|--------|
| 1.0 | Petrol | 74, 88 | 7.15 | - | 910287 |
| 1.4 | Petrol | 72, 73, 74 | 9.12 | 4.14 | 910284 |
| | | | 5.14 | - | 910287 |
| | Diesel | 66 | 9.12 | 4.15 | 910284 |
| | | | 5.15 | - | 910287 |
| 1.6 | Petrol | 95, 96 | 11.14 | - | 910287 |
| | | 99 | 9.12 | 4.15 | 910284 |
| | Diesel | 81, 94, 100 | 5.15 | - | 910287 |
| | | | 9.12 | 4.14 | 910284 |
| | | | 5.14 | - | 910287 |

2) → 4.15

ProCee'd (JD)

| | | | | | | | |
|---|-------------|--|------------------------|--|---|--------|--|
| 1.4 CVVT, 1.4 MPI, 1.6 CVVT, 1.6 GDI (JD) 1.4 CRDi 90 Incl. Sport sus., Special Edition | 3.13 - | | 3340163 L 3340162 R | | | 349084 | |
| | | | SM1044 ¹⁾ | | 910179 ²⁾ SM5669 ²⁾ | | |
| 1.0 T-GDI (JD) 1.6 CRDi 110, 1.6 CRDi 128, 1.6 CRDi 136 Incl. Sport sus. Exc. Special Edition, | 3.13 - | | 3340163 L 3340162 R | | | 349084 | |
| | | | SM1044 ¹⁾ | | 910179 ²⁾ SM5669 ²⁾ | | |
| 1.0 T-GDI (JD) 1.6 CRDi 110, 1.6 CRDi 128, 1.6 CRDi 136 Special Edition, | 3.13 - | | | | | 349084 | |
| | | | SM1044 ¹⁾ | | 910179 ²⁾ SM5669 ²⁾ | | |
| 1.6 GT (JD) Incl. Sport sus., Special Edition, | 6.13 - 4.15 | | 3340163 L 3340162 R | | | 349084 | |
| | | | | | 910179 SM5669 | | |
| 1.6 GT (JD) Incl. Sport sus., Special Edition, | 5.15 - | | | | | 349084 | |

1) Exc. Special Edition 2) → 4.15

Cerato I

| | | | | | | | | |
|--|------|---------|-------------------|----------------------|--------|--|----------------------|--|
| | (LD) | 04 - 08 | | 333491 L 333490 R | | | 333493 L 333492 R | |
| | | | 910147▼ 910022 | | 910150 | | | |

Cerato II

| | | | | | | | | |
|-----|------|------------|--|----------------------|--|--|--------|--|
| 1.6 | (TD) | 08 - 12.12 | | 338027 L 338026 R | | | 554385 | |
|-----|------|------------|--|----------------------|--|--|--------|--|

Cerato III

| | | | | | | | | |
|--|------|------|--|--------|--|--|--|--|
| | (YD) | 12 - | | | | | | |
| | | | | SM1044 | | | | |

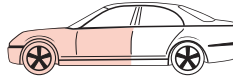

| MODEL FAHRZEUG MODELE | YEAR JAHR ANNEE | FRONT/VORNE/AVANT | | | REAR/HINTEN/ARRIERE | |
|--|-----------------------|-----------------------------|-----------------------------|--|---------------------|-----------------------------|
| | | PREMIUM Twin-tube Oil | EXCEL-G Twin-tube Gas | GAS-A-JUST Mono-tube Gas | | PREMIUM Twin-tube Oil |
| Kia (KO) | | | | | | |
| Clarus | | | | | | |
| ALL Incl. ABS | (GC) | 96 - | 634101 L▼ 634100 R▼ | 334232 L 334231 R | | 334234 L▼ 334233 R▼ |
| Joice | | | | | | |
| ALL Incl. ABS | (M300E) | 99 - | 634042 | 334070 | | 443265 343262▼ |
| Magentis | | | | | | |
| ALL | (GD) | 2.01 - 12.05 | | 341280 | | 341281 910173 SM5091 |
| 2.0 (106 kW), 2.0 CRDi (103 kW) 2.7 | (MG) | 11.05 - 6.08 | | 334509 L▼ 334508 R▼ 3340084 L 3340083 R MB1901 SM5663 L SM5662 R | | 3440021 |
| 2.0 CRDi (100 kW, 110 kW) 2.0 CRDi (103 kW), 2.7 2.7 V6 | (MG) | 11.05 - 7.08 - 7.09 - | | 3340116 L 3340115 R MB1901 SM5663 L SM5662 R | | 3440021 |
| 2.0 | (MG) | 7.08 - | | 3340116 L 3340115 R MB1901 SM5663 L SM5662 R | | |
| Niro | | | | | | |
| e-Niro (150 kW) | (DE) | 8.18 - | | | | 3440114 |
| Optima | | | | | | |
| 2.0, 2.0 CVVT (110 kW), 2.4 Incl. Sport sus. Exc. Hybrid | (TF) | 6.10 - | | SM5792 | | 349243 |
| 1.7 CRDi, 2.0 CVVL Exc. | (TF) | 3.12 - | | SM5792 | | 349243 |
| 1.6 T-GDi 1.6 CRDi, 1.7 CRDi Incl. Exc. | (JF) | 11.15 - | | | | 3440061 |
| 2.0, 2.0 CVVL, 2.0 T-GDi (180 kW) 2.4 GDi Exc. Hybrid, | (JF) | 9.15 - | | | | 3440061 |
| Optima Sportswagon | | | | | | |
| 1.6 T-GDi Exc. | (JF) | 1.18 - | | | | 3440061 |



Kia

| MODEL FAHRZEUG MODELE | YEAR JAHR ANNEE | FRONT/VORNE/AVANT | | | | REAR/HINTEN/ARRIERE | | | |
|--|-----------------------|-----------------------------|-----------------------------|--|--|-----------------------------|-----------------------------|--------------------------------|--|
| | | PREMIUM Twin-tube Oil | EXCEL-G Twin-tube Gas | GAS-A-JUST Mono-tube Gas | | PREMIUM Twin-tube Oil | EXCEL-G Twin-tube Gas | GAS-A-JUST Mono-tube Gas | |
| Kia (KO) | | | | | | | | | |
| Picanto | | | | | | | | | |
| | (SA) | 4.04 - | | 332501 L 332500 R | | | 343405 | | |
| | | | 910146 | SM1015 | | 910149 | SM9943 | | |
| | (TA) | 5.11 - | | 3320021 L 3320020 R | | | 348053 | | |
| | | | | SM5819 | | 910335◇ | SM9943 | | |
| Exc. | (JA) | 3.17 - | | | | | 343405 | | |
| Pride | | | | | | | | | |
| | | 96 - | 6320002 L 6320001 R | 332055 L 332054 R | | 6410001 | 341079 | | |
| Rio I | | | | | | | | | |
| Incl. ABS | (DC) | 9.00 - 7.02 | | 333503 L 333502 R | | | 343353 | | |
| | | | 910212 | SM5454 | | | | | |
| Incl. ABS | (DC) | 7.02 - 5.05 | | 333513 L 333512 R | | | 343424 | | |
| | | | 910213 | SM5478 L SM5477 R | | | | | |
| Rio II | | | | | | | | | |
| | (JB) | 3.05 - | | 333517 L▼ 333516 R▼ 3330053 L 3330052 R | | | 348007 | | |
| | | | 910147▼ | MB1901 | | 910151 | SM5656 | | |
| | | | 910022 | SM5670 | | | | | |
| Rio III | | | | | | | | | |
| 1.2, 1.2 CVVT, 1.25 CVVT (63kW) 1.25 LPG, 1.4 CVVT, 1.4 LPG 1.1 CRDi, 1.4 CRDi | (UB) | 9.11 - | | 338107 L 338106 R | | | | 554384 | |
| | | | | SM5819 ¹⁾ | | | | | |
| 1.6 CVVT | (UB) | 6.12 - | | | | | 349098 | | |
| | | | | SM5819 ¹⁾ | | | | | |
| 1) Exc. | | | | | | | | | |
| Rio III | | | | | | | | | |
| 1.25 CVVT, 1.4 CVVT Exc. | (UB) | 6.11 - | | 338107 L 338106 R | | | | 554384 | |
| | | | | SM5819 | | | | | |
| 1.4 CVVT | (UB) | 6.11 - | | | | | 349098 | | |

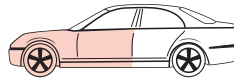

| MODEL FAHRZEUG MODELE | YEAR JAHR ANNEE | FRONT/VORNE/AVANT | | | | REAR/HINTEN/ARRIERE | | | |
|---|------------------------|-----------------------------|--|--------------------------------|--|-----------------------------|-----------------------------|--------------------------------|--|
| | | PREMIUM Twin-tube Oil | EXCEL-G Twin-tube Gas | GAS-A-JUST Mono-tube Gas | | PREMIUM Twin-tube Oil | EXCEL-G Twin-tube Gas | GAS-A-JUST Mono-tube Gas | |
| Kia (KO) | | | | | | | | | |
| Rio IV | | | | | | | | | |
| 1.0 T-GDI 100, 1.0 T-GDI 120 (YB, SC, FB) 1.25, 1.4, 1.4 CRDi 77, 1.4 CRDi 90 Exc. Eco-Dynamics+, LPG, X-Line | 1.17 - | | | | | | 3430076 | | |
| 1.4 (101 kW) (YB, SC, FB) ⊕ X-Line, | 1.17 - | | | | | | 3430076 | | |
| Rio IV | | | | | | | | | |
| 1.4, 1.6 (90 kW) (SC, FB) | 7.17 - 11.18 | | | | | | 348007 | | |
| Sephia I | | | | | | | | | |
| (FA) | 93 - 12.97 | 633249 L ▼ 633248 R ▼ | 333370 L ▼ 333369 R ▼ | | | 633251 L ▼ 633250 R ▼ | 333372 L ▼ 333371 R ▼ | | |
| | | | SM5234 | | | | SM5233 L SM5232 R | | |
| Shuma, Spectra (RUS, IzhAuto) | | | | | | | | | |
| Shuma I / Sephia II Incl. ABS | 98 - 12.98 | | 333263 L ¹⁾ 333262 R ¹⁾ | | | | 333265 L 333264 R | | |
| | | | SM5308 | | | | SM5233 L SM5232 R | | |
| Shuma I Incl. ABS | 1.99 - 4.01 | | 333315 L ²⁾ 333314 R ²⁾ | | | | 333265 L 333264 R | | |
| | | | SM5308 | | | | SM5233 L SM5232 R | | |
| Shuma II Spectra (RUS, IzhAuto) Incl. ABS | 5.01 - 8.04 05 - 11 | | 333317 L 333316 R | | | | 333365 L 333364 R | | |
| | | 910075 | SM5479 | | | | SM5480 L SM5481 R | | |
| 1) without stabilizer bracket 2) with stabilizer bracket | | | | | | | | | |
| Sorento I | | | | | | | | | |
| 2.4, 2.5 CRDi, 3.3 V6, 3.5 V6 (JC) | 8.02 - 8.06 | | 341365 L 341364 R | | | | 344451 | | |
| | | 910075 | SM5455 | | | | Exc. , | | |
| 2.5 CRDi, 3.3 V6 (JC) | 9.06 - 6.07 | | 340046 L 340045 R | | | | 349115 | | |
| 2.5 CRDi, 3.3 V6 (JC) | 7.07 - | | 341365 L 341364 R | | | | 349115 | | |
| | | 910075 | SM5455 | | | | | | |



| MODEL FAHRZEUG MODELE | YEAR JAHR ANNEE | FRONT/VORNE/AVANT | | | | REAR/HINTEN/ARRIERE | | | |
|--|------------------------|-----------------------------|-----------------------------|--------------------------------|--|-----------------------------|-----------------------------|--------------------------------|--|
| | | PREMIUM Twin-tube Oil | EXCEL-G Twin-tube Gas | GAS-A-JUST Mono-tube Gas | | PREMIUM Twin-tube Oil | EXCEL-G Twin-tube Gas | GAS-A-JUST Mono-tube Gas | |
| Kia (KO) | | | | | | | | | |
| Sorento II | | | | | | | | | |
| <u>2WD</u> (XM) 2.4 CVVT, 2.4 LPG 2.0 CRDi (110 kW), 2.2 CRDi (145 kW) Incl. Sport sus., Panorama sunroof Exc. | 11.09 - 9.12 | | 3340122 L 3340121 R | | | | 341716▼ 3440028 | | |
| | | | | SM5791 ▼ SM5776 | | | | | |
| <u>2WD</u> (XM) 2.4 CVVT, 2.4 GDi (141 kW), 2.4 LPG 2.0 CRDi (110 kW), 2.2 CRDi (145 kW) Exc. | 10.12 - | | 3340195 L 3340194 R | | | | 3410081 | | |
| | | | | | | | | | |
| <u>4WD</u> (XM) 2.4 CVVT, 2.4 LPG 2.0 CRDi (110 kW), 2.2 CRDi Incl. Sport sus., Panorama sunroof Exc. | 11.09 - 9.12 | | 3340122 L 3340121 R | | | | 3440028 | | |
| | | | | SM5791 ▼ SM5776 | | | | | |
| <u>4WD</u> (XM) 2.4 CVVT, 2.4 GDi (141 kW), 2.4 LPG 2.0 CRDi (110 kW), 2.2 CRDi Exc. | 10.12 - | | 3340195 L 3340194 R | | | | 3440072 | | |
| | | | | | | | | | |
| Sorento III | | | | | | | | | |
| <u>2WD</u> (UM) 2.4 (129 kW), 3.5 D-CVVT (183 kW) 2.2 CRDi (147 kW) Exc. | 1.15 - | | | | | | 3440126◇ | | |
| | | | | | | | | | |
| <u>4WD</u> (UM) 2.4 (129 kW), 2.4 GDi (138 kW) 2.0 CRDi (136 kW), 2.2 CRDi (145 kW, 147 kW) Exc. | 1.15 - | | | | | | 3440126◇ | | |
| | | | | | | | | | |
| <u>4WD</u> (UM) 3.5 D-CVVT (183 kW) Exc. | 12.18 - | | | | | | 349187 | | |
| | | | | | | | | | |
| Soul I | | | | | | | | | |
| 1.6, 1.6 CVVT, 1.6 GDi, 1.6 LPG 1.6 CRDi 115, 1.6 CRDi 128 (AM) | 2.09 - 2.09 - 11.11 | | 3330120 L◇ 3330119 R◇ | | | | 349132 | 554387▼ | |
| | | | | SM5731 | | | | | |
| 1.6 CRDi 115, 1.6 CRDi 128 (AM) | 12.11 - | | | | | | 349132 | 554387▼ | |
| | | | | SM5731 | | | | | |
| Sportage (94-05) | | | | | | | | | |
| ALL (K00) | 9.94 - 12.98 | | 341190 | | | | 344359 | 554094 | |
| | | | | SM5453 | | | | | |
| ALL (K00) | 1.99 - 8.03 | | 341395 L 341394 R | | | | 344359 | 554094 | |
| | | | | SM5453 | | | | | |



| MODEL FAHRZEUG MODELE | YEAR JAHR ANNEE | FRONT/VORNE/AVANT | | | | REAR/HINTEN/ARRIERE | | | |
|--|-----------------------|-----------------------------|-----------------------------|--------------------------------|--|-----------------------------|--|--------------------------------|--|
| | | PREMIUM Twin-tube Oil | EXCEL-G Twin-tube Gas | GAS-A-JUST Mono-tube Gas | | PREMIUM Twin-tube Oil | EXCEL-G Twin-tube Gas | GAS-A-JUST Mono-tube Gas | |
| Kia (KO) | | | | | | | | | |
| Sportage (04-) | | | | | | | | | |
| (2WD) (4WD) Exc. | (JE, KM) | 9.04 - | | 339743 L 339742 R | | | 334505 L ▼ 334504 R ▼ 339747 L 339746 R | | |
| | | | 910078 | SM5295 | | | 910064 SM5239 L SM5240 R | | |
| (2WD) (4WD) | (JE, KM) | 9.04 - | | | | | 334505 L ▼ 334504 R ▼ 339747 L 339746 R | | |
| | | | 910078 | SM5295 | | | 910064 SM5239 L SM5240 R | | |
| Sportage (10-) | | | | | | | | | |
| (2WD) 1.6 LPG, 2.0 CVVT (110 kW, = G4NA) 2.0 CVVT (113 kW), 2.0 GDi (122 kW) Incl. Sport sus. | (SL) | 1.14 - | | 339403 L 339402 R | | | 349243 | | |
| | | | 910250 | SM1005 | | | 910293 ¹⁾ SM5850 | | |
| (2WD) 1.6 GDi (99 kW), 2.0 CVVT (120 kW, 122 kW) 1.7 CRDi, 2.0 CRDi (100 kW, 135 kW) | (SL) | 7.10 - | | 339403 L 339402 R | | | 349244 | | |
| | | | 910250 | SM1005 | | | 910293 ¹⁾ SM5850 | | |
| (2WD) 2.0 CVVT (110 kW, = G4KD) | (SL) | 6.10 - 12.13 | | 339403 L 339402 R | | | 349243 | | |
| | | | 910250 | SM1005 | | | 910293 ¹⁾ SM5850 | | |
| (2WD) 2.0 CVVT (110 kW, = G4KD) | (SL) | 6.10 - 12.13 | | 339403 L 339402 R | | | 349244 | | |
| | | | 910250 | SM1005 | | | 910293 ¹⁾ SM5850 | | |
| (4WD) 2.0 CVVT (kW : 110, 113, 120, 122) 2.0 GDi (122 kW) 2.0 CRDi Incl. Sport sus. | (SL) | 6.10 - | | 339403 L 339402 R | | | 349189 | | |
| | | | 910250 | SM1005 | | | 910293 ¹⁾ SM5850 | | |
| Sportage (10-) | | | | | | | | | |
| (2WD) 2.0 CVVT (kW : 110, 113, 120, 122) 2.0 GDi (122 kW) 2.0 CRDi (100 kW, 135 kW) Incl. Sport sus. | (SL) | 6.10 - | | 339403 L 339402 R | | | 349243 | | |
| | | | 910250 | SM1005 | | | 910293 ¹⁾ SM5850 | | |
| (4WD) 2.0 CVVT (110 kW, = G4KD) 2.0 CVVT (120 kW, 122 kW) 2.0 CRDi Exc. Sport sus. | (SL) | 6.10 - | | 339403 L 339402 R | | | 349189 | | |
| | | | 910250 | SM1005 | | | 910293 ¹⁾ SM5850 | | |
| 1) Exc. Sport sus. | | | | | | | | | |



Kia

| MODEL FAHRZEUG MODELE | YEAR JAHR ANNEE | FRONT/VORNE/AVANT | | | | REAR/HINTEN/ARRIERE | | | |
|--|---|-----------------------------|-----------------------------|--------------------------------|--|-----------------------------|-----------------------------|--------------------------------|--|
| | | PREMIUM Twin-tube Oil | EXCEL-G Twin-tube Gas | GAS-A-JUST Mono-tube Gas | | PREMIUM Twin-tube Oil | EXCEL-G Twin-tube Gas | GAS-A-JUST Mono-tube Gas | |
| Kia (KO) | | | | | | | | | |
| Sportage (10-) | | | | | | | | | |
| (4WD) 2.0 CVVT (110 kW, = G4KD) 2.0 CVVT (120 kW, 122 kW) 2.0 CRDi ⊕ Sport sus. | (SL) 6.10 - | | 339403 L 339402 R | | | 349187 | | | |
| | | 910250 | SM1005 | | | SM5850 | | | |
| (4WD) 2.0 CVVT (110 kW, = G4NA) 2.0 CVVT (113 kW), 2.0 GDi (122 kW) | (SL) 1.14 - | | 339403 L 339402 R | | | 349187 | | | |
| | | 910250 | SM1005 | | | SM5850 | | | |
| Sportage IV (16-) | | | | | | | | | |
| 1.6 CRDi (2WD) (4WD) (QL, QLE) 1.6 CRDi Eco-Dynamics+ (2WD) | 7.18 - | | | | | 3440062 | | | |
| | | 910318 | | | | | | | |
| 1.6 CRDi Eco-Dynamics+ (4WD) (QL, QLE) 1.6 GDi (97 kW) (2WD) 1.6 T-GDi (2WD) (4WD) 1.7 CRDi (2WD) 2.0 CRDi (100 kW, 136 kW) (2WD) 2.0 CRDi Eco-Dynamics+ (4WD) | 9.15 - | | | | | 3440122 | | | |
| | | 910318 | | | | | | | |
| 2.0 (110 kW, 114 kW) (2WD) (QL, QLE) 2.4 GDi (2WD) (4WD) (QL, QLE) ⊕ Sport sus. | 12.15 - 9.15 - 5.18 | | | | | 3440062 | | | |
| | | 910318 | | | | | | | |
| 2.0 (4WD) (QL, QLE) 2.0 CRDi (100 kW, 136 kW) (4WD) ⊕ | 9.15 - | | | | | 3440122 | | | |
| | | 910318 | | | | | | | |
| 2.0 (4WD) (QL, QLE) 2.0 CRDi (100 kW, 136 kW) (4WD) ⊕ , Sport sus. | 9.15 - | | | | | 3440062 | | | |
| | | 910318 | | | | | | | |
| Stonic | | | | | | | | | |
| ALL | (YB) 7.17 - | | | | | 348007 | | | |
| Venga | | | | | | | | | |
| 1.4 CRDi 75, 1.4 CRDi 90 1.6 CRDi 115, 1.6 CRDi 128 | (YN) 2.10 - 4.11 | | | | | 349098 | | | |
| | | 910270 ¹⁾ | SM5818 ³⁾ | | | | | | |
| 1.4 CVVT, 1.4 LPG, 1.6 CVVT 1.4 CRDi 75, 1.4 CRDi 90 1.6 CRDi 115, 1.6 CRDi 128 | (YN) 2.10 - 12.15 5.11 - 12.15 5.11 - 12.15 | | 3330122 L 3330121 R | | | 349098 | | | |
| | | 910270 ¹⁾ | SM5818 ³⁾ | 910269 ²⁾ | | | | | |
| ALL | (YN) 1.16 - | | | | | 349098 | | | |
| | | 910269 ²⁾ | SM5818 ³⁾ | | | | | | |
| 1) → 4.11 2) 5.11 → 3) ⊕ : 2.10 → ⊕ : 9.11 → 3.15 | | | | | | | | | |
| Kia Commercial (KO) | | | | | | | | | |
| Pregio | | | | | | | | | |
| ALL | (FP) 10.97 - | 441109 | 341247 | | | 344292 | | | |

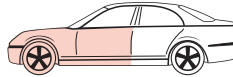

| MODEL FAHRZEUG MODELE | YEAR JAHR ANNEE | FRONT/VORNE/AVANT | | | | REAR/HINTEN/ARRIERE | | | |
|--|---|-----------------------------|-----------------------------|--------------------------------|--|-----------------------------|-----------------------------|--------------------------------|--|
| | | PREMIUM Twin-tube Oil | EXCEL-G Twin-tube Gas | GAS-A-JUST Mono-tube Gas | | PREMIUM Twin-tube Oil | EXCEL-G Twin-tube Gas | GAS-A-JUST Mono-tube Gas | |
| Lada (VAZ) (RUS) | | | | | | | | | |
| 110 / 111 / 112 | | | | | | | | | |
| | 1.95 - | 665503 | 365507 <u>375038</u> | | | 441824 | 341824 <u>351021</u> | | |
| 1) Exc. 1500 16V (67kW) (110/111), 1600 (110/111/112), 2000 (110), Wankel (110) | | | | | | | | | |
| Kalina | | | | | | | | | |
| 1.4 16V, 1.6, 1.6 16V (1118, 1119, 1117) | 10.04- 2.13 | | | | | 441824 | 341824 | | |
| Largus (R90) [4.12 -] → Renault Logan MCV (KS) [4.07 -] | | | | | | | | | |
| Niva | | | | | | | | | |
| Exc. 21214M, 4x4M (2121-) | 78- 11 | 443122 | 343097 | 553121▼ <u>243015</u> | | 443123 | 343098 | 553005▼ <u>243016</u> | |
| Priora | | | | | | | | | |
| 1.6, 1.6 LPG (2170, 2171, 2172) | 12.08- | | | | | 441824 | 341824 | | |
| Samara, Riva, Diva, Forma, Sagona | | | | | | | | | |
| 1100, 1300, 1500 (2108, 2109, 21099) (2113, 2114, 2115) | 86- | 665059 | 365057 <u>375037</u> | | | 441824 | 341824 <u>351021</u> | | |
| 1) → 99 | | | | | | | | | |
| VAZ, Nova, Toscana | | | | | | | | | |
| 1200, 1300, 1500, 1600 (2101, 2102, 2103, 2104, 2105, 2106, 2107, 21011, 21061) | 70- | 443122 | 343097 | 553121▼ <u>243015</u> | | 443123 | 343098 | 553005▼ <u>243016</u> | |
| X Ray | | | | | | | | | |
| (GAB_) 2.16- | | | 3338042 | | | | | | |
| Lancia (I) | | | | | | | | | |
| Dedra (835) | | | | | | | | | |
| 1.6 (835AA, AB, AN, BA) 1.8 (835AC, AD, BC, AT, BD, CD) 2.0 (835AI, AL) 1.9 TD (835AG, AS) 2.0 Turbo (835AO, AP, AQ, AR) Exc. | 3.89- 6.94 3.89- 6.94 3.89- 6.94 3.89- 6.94 12.90- 6.94 | | 334848 <u>324848</u> | | | | 344115 | 554077 | |
| 916002▼ SM1802 L▼ 910086▼ SM1803 R▼ | | | | | | | | | |



Lancia

| MODEL FAHRZEUG MODELE | YEAR JAHR ANNEE | FRONT/VORNE/AVANT | | | | REAR/HINTEN/ARRIERE | | | |
|---|--|-----------------------------|--|--------------------------------|--|-----------------------------|-----------------------------|--------------------------------|--|
| | | PREMIUM Twin-tube Oil | EXCEL-G Twin-tube Gas | GAS-A-JUST Mono-tube Gas | | PREMIUM Twin-tube Oil | EXCEL-G Twin-tube Gas | GAS-A-JUST Mono-tube Gas | |
| Lancia (I) | | | | | | | | | |
| Dedra (835) | | | | | | | | | |
| (4WD) 2.0 Turbo Integrale Exc. | (835) 12.90 - 6.94 | | 334848 <u>324848</u> | | | | | 554077 | |
| | | | 916002 ▼ SM1802 L ▼ 910086 ▼ SM1803 R ▼ | | | | | | |
| (2WD) 1.6 1.8 2.0 1.9 TD Exc. | (835EB, EI) (835FA, FG) (835ED) (835EE) 7.94 - 9.99 7.94 - 9.99 7.94 - 9.99 7.94 - 9.99 | | 334848 <u>324848</u> | | | | 344115 | 554077 | |
| | | | 916002 ▼ SM1802 L ▼ 910086 ▼ SM1803 R ▼ | | | | | | |
| (2WD) 1.8 1.9 TD Exc. | (835EH) (835EF) 3.96 - 12.97 7.94 - 12.97 | | 334848 <u>324848</u> | | | | 344115 | 554077 | |
| | | | 916002 ▼ SM1802 L ▼ 910086 ▼ SM1803 R ▼ | | | | | | |
| (2WD) 1.8 1.9 TD Exc. | (835EH) (835EF) 12.97 - 9.99 12.97 - 9.99 | | 334861 | | | | 344115 | 554077 | |
| | | | | | | | | | |
| Dedra (835) | | | | | | | | | |
| (2WD) 1.6 1.8 2.0 1.9 TD Exc. | (835EB, EI) (835FA, GF) (835ED) (835EE, EF) 9.94 - 9.99 9.94 - 9.99 9.94 - 9.99 9.94 - 9.99 | | 334848 <u>324848</u> | | | | 344115 | 554077 | |
| | | | 916002 ▼ SM1802 L ▼ 910086 ▼ SM1803 R ▼ | | | | | | |
| (2WD) 1.8 Exc. | (835EH) 3.96 - 12.97 | | 334848 <u>324848</u> | | | | 344115 | 554077 | |
| | | | 916002 ▼ SM1802 L ▼ 910086 ▼ SM1803 R ▼ | | | | | | |
| (2WD) 1.8 Exc. | (835EH) 12.97 - 9.99 | | 334861 | | | | 344115 | 554077 | |
| | | | | | | | | | |
| (4WD) 2.0 Integrale | (835ED) 9.94 - 9.99 | | 334848 <u>324848</u> | | | | 344115 | 554077 | |
| | | | 916002 ▼ SM1802 L ▼ 910086 ▼ SM1803 R ▼ | | | | | | |
| Delta | | | | | | | | | |
| 1.4, 1.6, 1.8, 2.0 16V Exc. 1.9 TD, 2.0 HF Turbo | (836) 9.93 - 99 | | 334848 <u>324848</u> | | | | 344115 | 554077 | |
| | | | 916002 ▼ SM1802 L ▼ 910086 ▼ SM1803 R ▼ | | | | | | |



| MODEL FAHRZEUG MODELE | YEAR JAHR ANNEE | FRONT/VORNE/AVANT | | | | REAR/HINTEN/ARRIERE | | | |
|---|-----------------------|---------------------------------|-----------------------------|--------------------------------|--|-----------------------------|-----------------------------|--------------------------------|--|
| | | PREMIUM Twin-tube Oil | EXCEL-G Twin-tube Gas | GAS-A-JUST Mono-tube Gas | | PREMIUM Twin-tube Oil | EXCEL-G Twin-tube Gas | GAS-A-JUST Mono-tube Gas | |
| Lancia (I) | | | | | | | | | |
| Delta | | | | | | | | | |
| 1.9 TD (836) | 9.93 - 99 | | | | | | 344115 | 554077 | |
| | | 916002▼ 910086▼ | | | | | | | |
| 2.0 HF Turbo (836) | 9.93 - 99 | | | | | | | | |
| | | 910086▼ SM1802 L▼ SM1803 R▼ | | | | | | | |
| Delta III 1.4, 1.4 16V, 1.4 Bifuel, 1.6 D Exc. | (844) 9.08 - | | 339785 | | | | 343826 | | |
| | | 910092 SM1816 | | | | 910013 SM9807 | | | |
| Delta III 1.8, 1.9 D, 2.0 D Exc. | (844) 9.08 - | | 339786 | | | | 343826 | | |
| | | 910092 SM1816 | | | | 910013 SM9807 | | | |
| Delta, Prisma (831) | | | | | | | | | |
| 1.3, 1.5, 1.6 (831) | 2.86 - 12.92 | | 335614 | | | | | | |
| | | 915210▼ | | | | 910084 | | | |
| 1.6 D, 1.6 TD, 1.9 D, 1.9 TD 1.6 HF Turbo (831) | 2.86 - 12.92 | | 335614 | | | | | | |
| | | 915210▼ | | | | 910084 | | | |
| 1.3, 1.5, 1.6, 1.6 D, 1.6 TD, 1.9 D, 1.9 TD 1.6 HF Turbo (831) | 1.93 - 8.93 | | 335614 | | | | | | |
| | | 915210▼ SM1802 L▼ SM1803 R▼ | | | | 910084 | | | |
| Kappa | | | | | | | | | |
| 2.0, 2.0 Turbo (838) 2.4, 3.0, 2.4 TD Exc. | 94 - 10.01 | | 335801 | | | | 335802 ¹⁾ | | |
| | | | | | | | SM9803 | | |
| 1) 335802 : OE p/n = 46448417, 46468555 | | | | | | | | | |
| Kappa | | | | | | | | | |
| 2.0, 2.0 Turbo (838) 2.4, 3.0, 2.4 TD Exc. | 96 - 10.01 | | 335801 | | | | | | |
| | | | | | | | OE = | | |
| Lybra | | | | | | | | | |
| 1.6, 1.8 (839) Exc. Self Leveling | 6.99 - 10.05 | | | | | | 343332 | | |
| | | 910251 SM1851 | | | | | | | |
| 2.0 (839) 1.9 JTD, 2.4 JTD Exc. Self Leveling | 6.99 - 10.05 | | 334612 | | | | 343332 | | |
| | | 910251 SM1851 | | | | | | | |



| Lancia | MODEL FAHRZEUG MODELE | YEAR JAHR ANNEE | FRONT/VORNE/AVANT | | | Wrench icon | REAR/HINTEN/ARRIERE | | | Wrench icon | | | | | | | | | | | | | | | | | | | | | | | | |
|---|-----------------------------|------------------------|---|-----------------------------|--------------------------------|-------------------------------|-----------------------------|-----------------------------|--------------------------------|-------------|--|--------|--|--------|-------------|--------|------------------------|--------------|-----------------|--------|------------------------|--|-------------|---------|------------------------|--|-------------|--------|------------------------|--|------------------------|---------|------------------------|---------|
| | | | PREMIUM Twin-tube Oil | EXCEL-G Twin-tube Gas | GAS-A-JUST Mono-tube Gas | | PREMIUM Twin-tube Oil | EXCEL-G Twin-tube Gas | GAS-A-JUST Mono-tube Gas | | | | | | | | | | | | | | | | | | | | | | | | | |
| Lancia (I) | | | | | | | | | | | | | | | | | | | | | | | | | | | | | | | | | | |
| Musa | | | | | | | | | | | | | | | | | | | | | | | | | | | | | | | | | | |
| | (350) | 7.04 - | | 334691 | | | | 343414 | | | | | | | | | | | | | | | | | | | | | | | | | | |
| 1.4, 1.4 LPG 1.3 JTD, 1.6 JTD, 1.9 JTD | | | 910014 SM1811 ¹⁾ | | | | | | | | | | | | | | | | | | | | | | | | | | | | | | | |
| 1) <table border="1"> <thead> <tr> <th></th> <th>SM1811</th> <th></th> <th>SM1811</th> </tr> </thead> <tbody> <tr> <td>1.4 (57 kW)</td> <td>→ 4.11</td> <td>1.3 D Multijet (66 kW)</td> <td>1.06 → 12.12</td> </tr> <tr> <td>1.4 LPG (57 kW)</td> <td>→ 4.11</td> <td>1.3 D Multijet (70 kW)</td> <td></td> </tr> <tr> <td>1.4 (66 kW)</td> <td>→ 12.12</td> <td>1.6 D Multijet (85 kW)</td> <td></td> </tr> <tr> <td>1.4 (70 kW)</td> <td>→ 4.11</td> <td>1.6 D Multijet (88 kW)</td> <td></td> </tr> <tr> <td>1.3 D Multijet (51 kW)</td> <td>→ 12.05</td> <td>1.9 D Multijet (74 kW)</td> <td>→ 12.05</td> </tr> </tbody> </table> | | | | | | | | | | | | SM1811 | | SM1811 | 1.4 (57 kW) | → 4.11 | 1.3 D Multijet (66 kW) | 1.06 → 12.12 | 1.4 LPG (57 kW) | → 4.11 | 1.3 D Multijet (70 kW) | | 1.4 (66 kW) | → 12.12 | 1.6 D Multijet (85 kW) | | 1.4 (70 kW) | → 4.11 | 1.6 D Multijet (88 kW) | | 1.3 D Multijet (51 kW) | → 12.05 | 1.9 D Multijet (74 kW) | → 12.05 |
| | SM1811 | | SM1811 | | | | | | | | | | | | | | | | | | | | | | | | | | | | | | | |
| 1.4 (57 kW) | → 4.11 | 1.3 D Multijet (66 kW) | 1.06 → 12.12 | | | | | | | | | | | | | | | | | | | | | | | | | | | | | | | |
| 1.4 LPG (57 kW) | → 4.11 | 1.3 D Multijet (70 kW) | | | | | | | | | | | | | | | | | | | | | | | | | | | | | | | | |
| 1.4 (66 kW) | → 12.12 | 1.6 D Multijet (85 kW) | | | | | | | | | | | | | | | | | | | | | | | | | | | | | | | | |
| 1.4 (70 kW) | → 4.11 | 1.6 D Multijet (88 kW) | | | | | | | | | | | | | | | | | | | | | | | | | | | | | | | | |
| 1.3 D Multijet (51 kW) | → 12.05 | 1.9 D Multijet (74 kW) | → 12.05 | | | | | | | | | | | | | | | | | | | | | | | | | | | | | | | |
| Phedra | | | | | | | | | | | | | | | | | | | | | | | | | | | | | | | | | | |
| | (179) | 9.02 - 11.10 | | 335934 L 335933 R | | | 443303 | 343321 | | | | | | | | | | | | | | | | | | | | | | | | | | |
| | | | MB1907 SM1916 L SM1917 R | | | | | | | | | | | | | | | | | | | | | | | | | | | | | | | |
| Thema | | | | | | | | | | | | | | | | | | | | | | | | | | | | | | | | | | |
| 2.0, 2.0 i.e., 2.0 i.e. Turbo 2.8 V6, 2.5 Turbo Diesel | | (834) | 11.84 - 10.86 | 334804 | | | | | | | | | | | | | | | | | | | | | | | | | | | | | | |
| | | | 913113 ▼ SM1807 ¹⁾ ▼ 910085 | | | SM9803 | | | | | | | | | | | | | | | | | | | | | | | | | | | | |
| 2.0 i.e., 2.0 i.e. 16V 2.0 i.e. Turbo, 2.5 Turbo Diesel 2.8 V6, 3.0 V6 Exc. 8.32 (3.0 V8) | | (834) | 11.86 - 95 | 334804 | | | | 334801 | | | | | | | | | | | | | | | | | | | | | | | | | | |
| | | | 913113 ▼ SM1807 ¹⁾ ▼ 910085 | | | 913113 ▼ SM9803 910085 | | | | | | | | | | | | | | | | | | | | | | | | | | | | |
| 1) 2.0 i.e. / 2.0 i.e. 8V | | | | | | | | | | | | | | | | | | | | | | | | | | | | | | | | | | |
| Voyager | | | | | | | | | | | | | | | | | | | | | | | | | | | | | | | | | | |
| | (RT, 404) | 9.11 - | | 339344 | | | | 349143 | | | | | | | | | | | | | | | | | | | | | | | | | | |
| Y | | | | | | | | | | | | | | | | | | | | | | | | | | | | | | | | | | |
| | | (840) | 95 - 9.03 | 333914 | | | | 343269 | 554086 | | | | | | | | | | | | | | | | | | | | | | | | | |
| 1.1, 1.2, 1.4 | | | SM1805 | | | 910084 | | | | | | | | | | | | | | | | | | | | | | | | | | | | |
| 1.2 Elefantino Rosso | | (840) | 95 - 9.03 | 334805 324805 | | | | | 554086 244039 ▼ | | | | | | | | | | | | | | | | | | | | | | | | | |
| | | | SM1805 | | | | | | | | | | | | | | | | | | | | | | | | | | | | | | | |
| Y10 | | | | | | | | | | | | | | | | | | | | | | | | | | | | | | | | | | |
| | | (156) | 3.85 - 93 | 331604 L 331603 R | | | 441077 | 341209 | | | | | | | | | | | | | | | | | | | | | | | | | | |
| 1000, 1050, 1300, Turbo | | | 913105 | | | | | | | | | | | | | | | | | | | | | | | | | | | | | | | |
| | | (156) | 85 - 93 | 331604 L 331603 R | | | 441094 | 341210 | | | | | | | | | | | | | | | | | | | | | | | | | | |
| | | | 913105 | | | | | | | | | | | | | | | | | | | | | | | | | | | | | | | |



| MODEL FAHRZEUG MODELE | YEAR JAHR ANNEE | FRONT/VORNE/AVANT | | | | REAR/HINTEN/ARRIERE | | | |
|--|-----------------------|-----------------------------|--|--------------------------------|--|-----------------------------|-----------------------------|--------------------------------|--|
| | | PREMIUM Twin-tube Oil | EXCEL-G Twin-tube Gas | GAS-A-JUST Mono-tube Gas | | PREMIUM Twin-tube Oil | EXCEL-G Twin-tube Gas | GAS-A-JUST Mono-tube Gas | |
| Lancia (I) | | | | | | | | | |
| Y10 | | | | | | | | | |
| 1000, 1050, 1300, Turbo | (156) | 93 - 96 | | 331604 L 331603 R | | | 341187 | | |
| | | | 913105 | | | | | | |
| | (156) | 93 - 96 | | 331604 L 331603 R | | | | | |
| | | | 913105 | | | | | | |
| Ypsilon | | | | | | | | | |
| | (843) | 10.03 - 12.11 | | 334691 | | | 343329 | | |
| | | | 910014 SM1811 | | | | | | |
| 0.9 TwinAir (63 kW) 1.2, 1.2 Bifuel (49 kW) 1.3 D Multijet (70 kW) | (312) | 5.11 - 8.12 | | 3348006 L 3348005 R | | | 348035 | | |
| | | | 910272 ¹⁾ SM1820 | | | | | | |
| 0.9 CNG, 0.9 TwinAir (59 kW) 1.2 Bifuel (51 kW) | (312) | 5.11 - | | | | | 348035 | | |
| | | | 910272 ¹⁾ SM1820 | | | | | | |
| 1) 5.11 - 8.12 | | | | | | | | | |
| Zeta | | | | | | | | | |
| | (220) | 5.95 - 1.98 | 634927 | 334927 | | 443277 ¹⁾ | 343296 ¹⁾ ▼ | | |
| | | | 910124 MB1907 SM1916 L SM1917 R | | | | | | |
| | (220) | 1.98 - 8.00 | 634927 | 334927 | | 443303 ²⁾ | 343321 ²⁾ | | |
| | | | 910124 MB1907 SM1916 L SM1917 R | | | | | | |
| | (220) | 9.00 - 9.02 | 634927 | 334927 | | 443303 ²⁾ | 343321 ²⁾ | | |
| | | | 910124 MB1907 SM1916 L SM1917 R | | | | | | |
| 1) L max. = 370mm 2) L max. = 400mm | | | | | | | | | |
| Land Rover (GB) | | | | | | | | | |
| Discovery | | | | | | | | | |
| Discovery Exc. | (SALL****) | 89 - 98 | 445037 | | | | 345005 | | |
| Discovery | (SALL****) | 99 - 11.04 | 445035 | | | 445036 | | | |



Land Rover

| MODEL FAHRZEUG MODELE | YEAR JAHR ANNEE | FRONT/VORNE/AVANT | | | | REAR/HINTEN/ARRIERE | | | |
|---|--------------------------------|-----------------------------|-----------------------------|--------------------------------|--|-----------------------------|-----------------------------|--------------------------------|--|
| | | PREMIUM Twin-tube Oil | EXCEL-G Twin-tube Gas | GAS-A-JUST Mono-tube Gas | | PREMIUM Twin-tube Oil | EXCEL-G Twin-tube Gas | GAS-A-JUST Mono-tube Gas | |
| Land Rover (GB) | | | | | | | | | |
| Discovery Sport | | | | | | | | | |
| (2WD) (4WD) (L550) 2.0, 2.0 P200 MHEV, 2.0 P250 MHEV, 2.0 Si4 2.0 eD4 E-Capability, 2.0 D, 2.0 D150 MHEV 2.0 D180 MHEV, 2.0 D240 MHEV 2.0 SD4, 2.0 TD4, 2.2 D → JT203211 Exc. FLEX, Hybrid | 9.14 - | | 3358017 L 3358016 R | | | | | | |
| | | 910326 | | | | | | | |
| Discovery Sport | | | | | | | | | |
| (2WD) (4WD) (L550) 2.0, 2.0 P200 MHEV, 2.0 P250 MHEV, 2.0 Si4 2.0 eD4 E-Capability, 2.0 D, 2.0 D150 MHEV 2.0 D180 MHEV, 2.0 D240 MHEV 2.0 SD4, 2.0 TD4, 2.2 D → KG446856 Exc. FLEX, Hybrid, Active sus. | 9.14 - | | 3358017 L 3358016 R | | | | | | |
| | | 910326 | | | | | | | |
| Discovery Sport | | | | | | | | | |
| (2WD) (4WD) (L550) 2.0, 2.0 P200 MHEV, 2.0 P250 MHEV, 2.0 Si4 2.0 eD4 E-Capability, 2.0 D, 2.0 D150 MHEV 2.0 D180 MHEV, 2.0 D240 MHEV 2.0 SD4, 2.0 TD4, 2.2 D → HH999999 Exc. FLEX, Hybrid | 9.14 - | | 3358017 L 3358016 R | | | | | | |
| | | 910326 ¹⁾ | | | | | | | |
| (2WD) (4WD) (L550) 2.0, 2.0 P200 MHEV, 2.0 P250 MHEV, 2.0 Si4 2.0 eD4 E-Capability, 2.0 D, 2.0 D150 MHEV 2.0 D180 MHEV, 2.0 D240 MHEV 2.0 SD4, 2.0 TD4, 2.2 D JH000001 → KH999999 Exc. FLEX, Hybrid, Exc. , Active sus., AMS conversion | 9.14 - | | 3358017 L 3358016 R | | | | | | |
| | | 910326 ¹⁾ | | | | | | | |
| 1) → KH999999 ; Exc. | | | | | | | | | |
| Freelander / Freelander Soft Top | | | | | | | | | |
| Freelander (LN) 1.8 i 16V (88 kW) 2.0 DI Exc. Soft Top | 10.97 - 10.00 10.97 - 10.00 | | | | | | 334624 L 334623 R | | |
| | | | | SM5586 | | | | SM5596 | |
| Freelander (LN) 1.3 IDSi, 1.4, 1.8 (86 kW) 2.0 Td4, 2.5 i Exc. Soft Top | 11.00 - 10.06 11.00 - 9.03 | | 335927 L 335926 R | | | | 334624 L 334623 R | | |
| | | | | SM5586 | | | | SM5596 | |
| Freelander Soft Top (LN) 1.8 i 16V 2.0 D | 10.97 - 10.00 10.97 - 10.00 | | | | | | 334624 L 334623 R | | |
| | | | | SM5586 | | | | SM5596 | |



| MODEL FAHRZEUG MODELE | YEAR JAHR ANNEE | FRONT/VORNE/AVANT | | | | REAR/HINTEN/ARRIERE | | | |
|---|---|-----------------------------|-----------------------------|--------------------------------|--|-----------------------------|-----------------------------|--------------------------------|--|
| | | PREMIUM Twin-tube Oil | EXCEL-G Twin-tube Gas | GAS-A-JUST Mono-tube Gas | | PREMIUM Twin-tube Oil | EXCEL-G Twin-tube Gas | GAS-A-JUST Mono-tube Gas | |
| Land Rover (GB) | | | | | | | | | |
| Freelander / Freelander Soft Top | | | | | | | | | |
| Freelander Soft Top (LN) 1.3 IDSi 2.0 D 1.8 i 16V | 11.00 - 10.06 11.00 - 10.06 11.00 - 9.03 | | 335927 L 335926 R | | | | 334624 L 334623 R | | |
| | | | | | | | | | |
| Freelander 2 (FA) 2.0 Si4 (177 kW), 2.2 eD4, 2.2 SD4 2.2 TD4, 3.2 | 10.06 - | | 335830 L 335829 R | | | | 335832 L 335831 R | | |
| | | | | | | | | | |
| Land Rover | | | | | | | | | |
| = 86" = 88" MK I & fire tender = 88" MK II, MK II A & MK III = 107" (Stat. Wagon) = 109" MK I | 53 - 6.56 56 - 2.58 2.58 - 53 - 11.58 53 - 2.58 | 444042 | | | | 444043 | | | |
| = 109" MK II MK II Staff car & fire tender W/D MK II A MK III | 2.58 - 8.61 58 - 62 2.58 - 9.71 9.71 - | 444042 | | | | 444044 H/D 445007 | | | |
| Land Rover 90 Land Rover 110 Defender 90 Defender 110 Defender 130 | 84 - 9.90 83 - 9.90 10.90 - 10.90 - 10.90 - | 445026 | 345014 | | | | 345005 | | |
| Range Rover | | | | | | | | | |
| Range Rover (SALLH****) Exc. | 6.70 - 86 | 445037 | | | | 445025 | | | |
| Range Rover (SALLH****) → GA417084 Incl. Exc. | 86 - 91 | 445037 | | | | 445025 | | | |
| Range Rover (SALLH****) → GA417084 Incl. Exc. | 86 - 91 | 445037 | | | | | 345005 | | |
| Range Rover (SALLH****) GA417084 → Incl. Exc. | 86 - 91 | 445037 | | | | | 345005 | | |
| Range Rover Classic (SALLH****) Exc. | 92 - 95 | 445037 | | | | | 345005 | | |
| Range Rover Classic (SALLH****) Exc. | 92 - 95 | 445038▼ | | | | | 345005 | | |
| Range Rover Classic (SALLH****) Incl. | 92 - 95 | 445037 | | | | | 345005 | | |



LDV

| MODEL FAHRZEUG MODELE | YEAR JAHR ANNEE | FRONT/VORNE/AVANT | | | | REAR/HINTEN/ARRIERE | | | |
|--|--|-----------------------------|-----------------------------|--------------------------------|--|-----------------------------|-----------------------------|--|--|
| | | PREMIUM Twin-tube Oil | EXCEL-G Twin-tube Gas | GAS-A-JUST Mono-tube Gas | | PREMIUM Twin-tube Oil | EXCEL-G Twin-tube Gas | GAS-A-JUST Mono-tube Gas | |
| Land Rover (GB) | | | | | | | | | |
| Range Rover II | | | | | | | | | |
| (LP) (SALLP*****) New Range Rover | 95 - 3.02 | 445042 | | | | 445043 | | | |
| Range Rover Evoque | | | | | | | | | |
| (L538) Incl. H/D Exc. 2.0 (179 kW), , , AMS conversion | 6.11 - 12.19 | | 3358017 L 3358016 R | | | | 3358019 L 3358018 R | | |
| Range Rover Evoque | | | | | | | | | |
| (L538) Exc. , | 11.15 - 12.19 | | 3358017 L 3358016 R | | | | | | |
| LDV Commercial (GB) | | | | | | | | | |
| Convoy | | | | | | | | | |
| 2.5 D, 2.5 TD Incl. | 4.96 - | 445080 | 345049▼ | | | 445081 | 345050▼ | | |
| Lexus (J) | | | | | | | | | |
| GS Exc. | | | | | | | | | |
| GS300 (JZS147) 3000-24V | 3.93 - 8.97 | | 341264 | | | | 341265 | | |
| GS300 3000-24V GS400, GS430 | (JZS160) 8.97 - 12.04 | | 341266 | SM5205 | | | 341267 | | |
| GS300, GS350 (2WD) | (GRS19) 4.05 - 11.11 | | | 551107 L 551106 R | | | | 551108 ¹⁾ SM5597 ¹⁾ | |
| 1) Incl. GS350 | | | | | | | | | |
| IS200 / IS300 | | | | | | | | | |
| IS200 2000-24V | (GXE10) 3.99 - 7.05 | | 341262 | SM5490 | | | 341263 | | |
| IS200 3000 V6 | (JCE10) 9.01 - 7.05 | | 341359 | SM5490 | | | 341263 | | |
| IS200 / IS300 2000-24V 3000 V6 | (GXE10W) (JCE10W) 9.02 - 7.05 9.01 - 7.05 | | 341359 | SM5490 | | | 341360 | | |
| IS II | | | | | | | | | |
| IS200 2.2 IS220 2.2 D | (ALE20) (ALE20) 7.10 - 10.05 - | | | 551131 L 551130 R | | | | 551132 | |
| IS250 | (GSE25) 10.05 - | | | 551127 L 551126 R | | | | 551132 | |
| IS250 | (GSE20) 10.05 - | | | 551131 L 551130 R | | | | 551132 | |



| MODEL FAHRZEUG MODELE | YEAR JAHR ANNEE | FRONT/VORNE/AVANT | | | | REAR/HINTEN/ARRIERE | | | |
|---|-----------------------|-----------------------------|--|--------------------------------|--|-----------------------------|--|--------------------------------|--|
| | | PREMIUM Twin-tube Oil | EXCEL-G Twin-tube Gas | GAS-A-JUST Mono-tube Gas | | PREMIUM Twin-tube Oil | EXCEL-G Twin-tube Gas | GAS-A-JUST Mono-tube Gas | |
| Lexus (J) | | | | | | | | | |
| IS III | | | | | | | | | |
| IS200t (ASE30) IS300h (AVE30_) Incl. Sport sus. Exc. | 6.15 - 4.13 - | | | 551131 L 551130 R | | | | 5540004 | |
| IS250 (GSE30_) Exc. Sport sus., | 4.13 - | | | | | | | 5540004 | |
| IS250 (GSE30_) ⊕ Sport sus. Exc. | 4.13 - | | | 551131 L 551130 R | | | | 5540004 | |
| LS400 Exc. TEMS | | | | | | | | | |
| 4000-32V (UCF10) | 12.89 - 10.94 | | 341159 | | | | 341268 | | |
| 4000-32V (UCF20) | 10.94 - 8.00 | | 341159 | | | | 341269 | | |
| LS460 | | | | | | | | | |
| (2WD) (255 kW, 280 kW) (_F4_) (4WD) (270 kW) (_F4_) Exc. | 4.06 - 12.08 - | | | 551122 | | | | 551124 L 551123 R | |
| NX | | | | | | | | | |
| (2WD) (4WD) 200, 200t, 300 Incl. (RUS) Exc. , Active sus. | (_Z1_) 7.14 - | | 3350001 L 3350000 R | | | | 349024 | | |
| (2WD) (4WD) 300h (114 kW, 145 kW) Incl. (RUS) Exc. , Active sus. | (_Z1_) 7.14 - | | 3350039 L 3350038 R | | | | 349024 | | |
| RX | | | | | | | | | |
| RX270 (AGL10) (2WD) | 12.08 - 2.12 | | 339282 L 339281 R | | | | | | |
| RX300 (ACU/MCU/SXU10) (2WD) | 12.97 - 2.03 | | 334262 L 334261 R | | | | 334270 L 334269 R | | |
| RX300 (ACU/MCU/SXU15) (4WD) | 12.97 - 2.03 | | 334262 L 334261 R 324041 L ▼ 324040 R ▼ | | | | 334264 L 334263 R 324043 L 324042 R | | |
| RX300 (MCU35) (2WD) (4WD) Exc. | 2.03 - 12.08 | | 334400 L 334399 R | | | | 334395 L 334394 R | | |
| | | | 910166 ¹⁾ SM5423 | | | | 935312 ¹⁾ SM5492 L SM5491 R | | |
| 1) ⊕ (4WD) | | | | | | | | | |



| MODEL FAHRZEUG MODELE | YEAR JAHR ANNEE | FRONT/VORNE/AVANT | | | | REAR/HINTEN/ARRIERE | | | |
|-----------------------------|-----------------------|-----------------------------|-----------------------------|--------------------------------|--|-----------------------------|-----------------------------|--------------------------------|--|
| | | PREMIUM Twin-tube Oil | EXCEL-G Twin-tube Gas | GAS-A-JUST Mono-tube Gas | | PREMIUM Twin-tube Oil | EXCEL-G Twin-tube Gas | GAS-A-JUST Mono-tube Gas | |
| Lexus (J) | | | | | | | | | |
| RX | | | | | | | | | |
| RX350 Exc. | (GGL1_) 12.08 - | | 339282 L 339281 R | | | | | | |
| RX400H | (MHU3_) 9.05 - 4.07 | | | | | | 334385 L 334384 R | | |
| | | | | SM5423 | | | | SM5492 L SM5491 R | |
| RX400H | (MHU3_) 5.07 - 12.08 | | | | | | 339209 L 339208 R | | |
| | | | | SM5423 | | | | SM5492 L SM5491 R | |
| RX400H | (MHU3_) 9.04 - 12.08 | | | | | | | | |
| | | | | 910166 SM5423 | | | | 935312 SM5492 L SM5491 R | |
| RX450H | (GYL1_) 12.08 - | | 339282 L 339281 R | | | | | | |

Mazda (J)

121

| | | | | | | | | | |
|---------------|-----------------|------------------------|----------------------|--|--|--|----------------|--|--|
| | (DA) 11.87 - 91 | 6320002 L 6320001 R | 332055 L 332054 R | | | | 341079 | | |
| | (DB) 91 - 96 | | 332069 L 332068 R | | | | 341167 | | |
| | (DB) 11.93 - 96 | | | | | | 341167 | | |
| 1.25, 1.3 | (AB) 96 - 10.98 | | 333701 | | | | 341712 | | |
| | | 910081 SM1204 | | | | | 913121 SM9200 | | |
| 1.25, 1.3 | (AB) 11.98 - | | 333701 | | | | 341953 | | |
| | | 910081 SM1204 | | | | | 913121 SM9200 | | |
| 1.25, 1.3 | (AB) 96 - 10.98 | | 333702 | | | | 341712 | | |
| | | 910081 SM1204 | | | | | 913121 SM9200 | | |
| 1.25, 1.3 | (AB) 10.98 - | | 333702 | | | | 341953 | | |
| | | 910081 SM1204 | | | | | 913121 SM9200 | | |
| 1.8 D | (AB) 96 - 10.98 | | 333703 | | | | 341712 | | |
| | | 910081 SM1204 | | | | | 913121 SM9200 | | |
| 1.8 D | (AB) 11.98 - | | 333703 | | | | 341953 | | |
| | | 910081 SM1204 | | | | | 913121 SM9200 | | |



| MODEL FAHRZEUG MODELE | YEAR JAHR ANNEE | FRONT/VORNE/AVANT | | | | REAR/HINTEN/ARRIERE | | | |
|---|-------------------------|-----------------------------|-----------------------------|--------------------------------|--|-----------------------------|-----------------------------|--------------------------------|--|
| | | PREMIUM Twin-tube Oil | EXCEL-G Twin-tube Gas | GAS-A-JUST Mono-tube Gas | | PREMIUM Twin-tube Oil | EXCEL-G Twin-tube Gas | GAS-A-JUST Mono-tube Gas | |
| Mazda (J) | | | | | | | | | |
| 121 | | | | | | | | | |
| 1.8 D | (AB) | 96 - 10.98 | | 333704 | | | 341712 | | |
| | | | 910081 | SM1204 | | 913121 | SM9200 | | |
| 1.8 D | (AB) | 11.98 - | | 333704 | | | 341953 | | |
| | | | 910081 | SM1204 | | 913121 | SM9200 | | |
| 323 (Type BD) (80-85) | | | | | | | | | |
| 1000, 1300, 1500 (BD1011/12, BD1031/32, BD1051/52) | | 6.80 - 85 | | | | 632005 L 632004 R | | | |
| | | | | | | 912003 ▼ 910082 | | | |
| 323 (Type BF) (85-89) | | | | | | | | | |
| 1100, 1300, 1500, 1700 Diesel Exc. 1500 XG, | (BF) | 7.85 - 5.89 | 633050 L 633049 R | 333026 L ▼ 333025 R ▼ | | 632035 L 632034 R | | | |
| | | | 913151 | | | 910082 | | | |
| 1500 XG, 1600 (EGI) Exc. | (BF5P, BFMP) | 7.85 - 5.89 | 633050 L 633049 R | 333026 L ▼ 333025 R ▼ | | 633112 L ▼ 633111 R ▼ | | | |
| | | | 913151 | | | | | | |
| Exc. EGI, H/D | (BF) | 7.85 - 5.89 | 633050 L 633049 R | 333026 L ▼ 333025 R ▼ | | | | | |
| | | | 913151 | | | | | | |
| 323 (Type BW) (86-94) | | | | | | | | | |
| 1300, 1500, 1600, 1700 Diesel Exc. | (BW12) | 1.86 - 10.95 | 633050 L 633049 R | 333026 L ▼ 333025 R ▼ | | | 333073 L ▼ 333072 R ▼ | | |
| | | | | | | | | | |
| 323 (Type BG) (89-94) Exc. | | | | | | | | | |
| Exc. | (BG) | 6.89 - 8.94 | 633138 L 633137 R | 333127 L 333126 R | | 633144 L 633143 R | 333133 L 333132 R | | |
| | | | 917001 | SM5305 | | 917002 ▼ 910082 | SM5046 | | |
| | (BG) | 6.89 - 8.94 | 633138 L 633137 R | 333127 L 333126 R | | 633089 L 633088 R | | | |
| | | | | SM5305 | | | SM5046 | | |
| 1.8i, 1.8i-Turbo Exc. Hi-Power Engine | (BG8 # F/H) (BG 83J) | 6.89 - 8.94 | 633114 L ▼ 633113 R ▼ | | | | | | |
| | | | | SM5305 | | | | | |
| 323 F (Type BG) (89-94) | | | | | | | | | |
| Exc. | (BG) | 6.89 - 8.94 | | 333131 L 333130 R | | 633144 L 633143 R | 333133 L 333132 R | | |
| | | | 917001 | SM5305 | | 917002 ▼ 910082 | SM5046 | | |



| MODEL FAHRZEUG MODELE | YEAR JAHR ANNEE | FRONT/VORNE/AVANT | | | REAR/HINTEN/ARRIERE | | |
|---|-----------------------|-----------------------------|--|--|--|-----------------------------|--------------------------------|
| | | PREMIUM Twin-tube Oil | EXCEL-G Twin-tube Gas | GAS-A-JUST Mono-tube Gas | PREMIUM Twin-tube Oil | EXCEL-G Twin-tube Gas | GAS-A-JUST Mono-tube Gas |
| Mazda (J) | | | | | | | |
| 323 F (Type BG) (89-94) | | | | | | | |
| (BG) + | 6.89 - 8.94 | | 333131 L 333130 R | | 633089 L 633088 R | | |
| 323 C, 323 S (Type BA) (,) (94-98) Exc. | | | | | | | |
| (BA) 1.3, 1.5, 1.8, 1.7 TD, 2.0 D - ABS | 9.94 - 5.98 | | 333179 L 333178 R | | 333181 L 333180 R | | |
| (BA) 1.3, 1.5, 1.8, 1.7 TD, 2.0 D + ABS → 151007 | 9.94 - 95 | | 333183 L ¹⁾ 333182 R ¹⁾ | | 333185 L ²⁾ 333184 R ²⁾ | | |
| (BA) 1.3, 1.5, 1.8, 1.7 TD, 2.0 D + ABS 151007 → | 95 - 5.98 | | 333179 L 333178 R | | 333181 L 333180 R | | |
| 1) 333182 R : O.E. = BC1D 34 700/700A, BC1F 34 700 333183 L : O.E. = BC1D 34 900/900A, BC1F 34 900 | | | | 2) 333184 R : O.E. = BC1D 28 700/700A/B/C, BC1F 28 700A/B 333185 L : O.E. = BC1D28 900/900A/B/C, BC1F 28 900A/B | | | |
| 323 F (Type BA) (94-98) | | | | | | | |
| (BA) 1.5, 1.8 - ABS | 9.94 - 5.98 | | 333179 L 333178 R | | 333181 L 333180 R | | |
| (BA) 1.5, 1.8 + ABS → 151007 | 9.94 - 95 | | 333183 L ¹⁾ 333182 R ¹⁾ | | 333185 L ²⁾ 333184 R ²⁾ | | |
| (BA) 1.5, 1.8 + ABS 151007 → | 95 - 5.98 | | 333179 L 333178 R | | 333181 L 333180 R | | |
| (BA) 2.0 - ABS | 9.94 - 5.98 | | 334118 L 334117 R | | 334120 L 334119 R | | |
| (BA) 2.0 + ABS → 151007 | 9.94 - 95 | | | | 334124 L ³⁾ ▼ 334123 R ³⁾ ▼ | | |
| 1) 333182 R : O.E. = BC1D 34 700/700A, BC1F 34 700 333183 L : O.E. = BC1D 34 900/900A, BC1F 34 900 | | | | 3) 334123 R : O.E. = B01C 28 700/A/B 334124 L : O.E. = B01C 28 900/A/B | | | |
| 2) 333184 R : O.E. = BC1D 28 700/700A/B/C, BC1F 28 700A/B 333185 L : O.E. = BC1D 28 900/900A/B/C, BC1F 28 900A/B | | | | | | | |



| MODEL FAHRZEUG MODELE | YEAR JAHR ANNEE | FRONT/VORNE/AVANT | | | | REAR/HINTEN/ARRIERE | | | |
|--|-----------------------|-----------------------------|-----------------------------|--------------------------------|--|-----------------------------|-----------------------------|--------------------------------|--|
| | | PREMIUM Twin-tube Oil | EXCEL-G Twin-tube Gas | GAS-A-JUST Mono-tube Gas | | PREMIUM Twin-tube Oil | EXCEL-G Twin-tube Gas | GAS-A-JUST Mono-tube Gas | |
| Mazda (J) | | | | | | | | | |
| 323 F (Type BA) (94-98) | | | | | | | | | |
| (2WD) 2.0 ⊕ ABS 151007 → | (BA) | 95 - 5.98 | | 334118 L 334117 R | | | 334120 L 334119 R | | |
| | | | 910024 | SM5150 | | | SM5405 L SM5406 R | | |
| 323 P (Type BA) (98-00) | | | | | | | | | |
| 1.3, 1.5, 2.0 D Incl. ABS | (BA) | 5.98 - 00 | | 333179 L 333178 R | | | 333181 L 333180 R | | |
| | | | 910024 | SM5150 | | 910100 | SM5405 L SM5406 R | | |
| 323 S (Type BJ) (98-03) | | | | | | | | | |
| 1.3, 1.4, 1.5, 1.6, 1.8, 1.9 2.0, 2.0 D, 2.0 TD Incl. ABS | (BJ) | 5.98 - 11.00 | | 333275 L 333274 R | | | 333277 L 333276 R | | |
| | | | 910025 | SM5427 | | 910100 | | | |
| 1.3, 1.4, 1.5, 1.6, 1.8, 2.0, 2.0 D, 2.0 TD (BJ) BJ1###400001 → Incl. ABS | (BJ) | 12.00 - 10.03 | | 333351 L 333350 R | | | 333277 L 333276 R | | |
| | | | 910025 | SM5427 | | 910100 | | | |
| 323 F (Type BJ) (98-03) | | | | | | | | | |
| (2WD) 1.3, 1.4, 1.5, 1.6, 1.8, 1.9 2.0, 2.0 D, 2.0 TD Incl. ABS | (BJ) | 98 - 11.00 | | 333275 L 333274 R | | | 333277 L 333276 R | | |
| | | | 910025 | SM5427 | | 910100 | | | |
| (2WD) 1.3, 1.4, 1.5, 1.6, 1.8, 1.9, 2.0, 2.0 D, 2.0 TD BJ1###400001 → Incl. ABS | (BJ) | 12.00 - 10.03 | | 333351 L 333350 R | | | 333277 L 333276 R | | |
| | | | 910025 | SM5427 | | 910100 | | | |
| 626, Montrose Exc. | | | | | | | | | |
| 1600, 1800, 2000, 2000 D | (GC) | 9.82 - 6.85 | 633029 L 633028 R | | | | | | |
| | | | 942016 | SM5307▼ | | | | | |
| 1600, 1800, 2000, 2000 D | (GD) | 7.85 - 5.87 | 633070 L 633069 R | | | | | | |
| | | | 942016 | SM5307▼ | | | | | |
| 1800, 2000, 2000 Diesel, 2200 Exc. , | (GD) | 6.87 - 92 | 634025 L 634024 R | | | 634026 | | | |
| | | | 942017 | SM5300 ¹⁾ ▼ | | 942016 | | | |
| (4WD) 2200 | (GD) | 8.89 - 92 | 634031 L▼ 634030 R▼ | | | | | | |
| (2WD) 1800, 2000, 2000 Diesel → 271863 Exc. , | (GE 1) | 8.91 - 93 | 634045 L 634044 R | 334083 L 334082 R | | 634026 | 334084 | | |
| | | | | SM5308 | | | SM5093 L▼ SM5094 R▼ | | |

1) ⊕



| MODEL FAHRZEUG MODELE | YEAR JAHR ANNEE | FRONT/VORNE/AVANT | | | | REAR/HINTEN/ARRIERE | | | |
|-----------------------------|-----------------------|-----------------------------|-----------------------------|--------------------------------|--|-----------------------------|-----------------------------|--------------------------------|--|
| | | PREMIUM Twin-tube Oil | EXCEL-G Twin-tube Gas | GAS-A-JUST Mono-tube Gas | | PREMIUM Twin-tube Oil | EXCEL-G Twin-tube Gas | GAS-A-JUST Mono-tube Gas | |

Mazda (J)

626, Montrose Exc.

| | | | | | | | | |
|---|--------|-----------|----------------------|--|--|--------|--|--|
| (2WD) 1800, 2000, 2000 Diesel 271863 Exc. | (GE 1) | 93 - 97 | 634045 L 634044 R | 334083 L 334082 R | | 634080 | 334157 ▼ | |
| | | | SM5308 | | 947003 SM5093 L ▼ SM5094 R ▼ | | | |
| (2WD) 1800, 2000, 2000 Diesel 280356 → Exc. | (GE 1) | 93 - 97 | 634052 L 634051 R | 334090 L ▼ 334089 R ▼ | | 634080 | 334157 ▼ | |
| | | | SM5308 | | 947003 SM5093 L ▼ SM5094 R ▼ | | | |
| (2WD) 2500 Exc. | (GE 1) | 8.91 - 97 | 634045 L 634044 R | 334083 L 334082 R | | 634046 | 334084 | |
| | | | SM5308 | | SM5093 L ▼ SM5094 R ▼ | | | |
| (2WD) 2500 Exc. | (GE 7) | 9.91 - 97 | 634045 L 634044 R | 334083 L 334082 R | | | 334085 ▼ | |
| | | | SM5308 | | SM5093 L ▼ SM5094 R ▼ | | | |
| (2WD) 2000 Exc. | (GE 8) | 9.91 - 97 | 634052 L 634051 R | 334090 L ▼ 334089 R ▼ | | | | |
| | | | SM5308 | | SM5093 L ▼ SM5094 R ▼ | | | |
| (2WD) 1.8, 1.9, 2.0, 2.0 HP, 2.0 TD | (GF 1) | 97 - | | 334198 L ¹⁾ 334197 R ¹⁾ | | | 334202 L ³⁾ 334201 R ³⁾ | |
| | | | SM5459 | | SM5093 L ⁴⁾ ▼ SM5094 R ⁴⁾ ▼ | | | |
| (2WD) 1.8, 1.9, 2.0, 2.0 HP, 2.0 TD (Exc. Self Leveling) | (GF 1) | 97 - | | 334200 L ²⁾ 334199 R ²⁾ | | | 334202 L ³⁾ 334201 R ³⁾ | |
| | | | SM5459 | | SM5093 L ⁴⁾ ▼ SM5094 R ⁴⁾ ▼ | | | |

1) 334197 R : O.E. = GE4T-34-700/-700A
334198 L : O.E. = GE4T-34-900/-900A
2) 334199 R : O.E. = GE4V-34-700/-700A
334200 L : O.E. = GE4V-34-900/-900A
3) 334201 R : O.E. = GE4T-28-700/-700A, GE4V-28-700/-700A
334202 L : O.E. = GE4T-28-900/-900A, GE4V-28-900/-900A
4) 97 - 00

626 Exc.

| | | | | | | | | |
|------------------|-------|------------|--------------------------|--|--|--------|--------------------------|--|
| (2WD) | (GV1) | 88 - 97 | 634025 L 634024 R | | | 635002 | 335002 ▼ | |
| | | | SM5300 ¹⁾ ▼ | | | | | |
| (2WD) | (GV8) | 10.89 - 97 | 634031 L ▼ 634030 R ▼ | | | | 335004 L ▼ 335003 R ▼ | |



| MODEL FAHRZEUG MODELE | YEAR JAHR ANNEE | FRONT/VORNE/AVANT | | | | REAR/HINTEN/ARRIERE | | | |
|--|-----------------------|--|-----------------------------|--|--|-----------------------------|--|--------------------------------|--|
| | | PREMIUM Twin-tube Oil | EXCEL-G Twin-tube Gas | GAS-A-JUST Mono-tube Gas | | PREMIUM Twin-tube Oil | EXCEL-G Twin-tube Gas | GAS-A-JUST Mono-tube Gas | |
| Mazda (J) | | | | | | | | | |
| 626 Exc. | | | | | | | | | |
| (2WD) 1.8, 1.9, 2.0, 2.0 HP, 2.0 TD | (GW1) | 97 - | | 334198 L ²⁾ 334197 R ²⁾ | | | 335029 L ⁴⁾ 335028 R ⁴⁾ | | |
| | | | | SM5459 | | | | | |
| (2WD) 1.8, 1.9, 2.0, 2.0 HP, 2.0 TD (Exc. Self Leveling) | (GW1) | 97 - | | 334200 L ³⁾ 334199 R ³⁾ | | | 335029 L ⁴⁾ 335028 R ⁴⁾ | | |
| | | | | SM5459 | | | | | |
| 1) 2) 334197 R : O.E. = GF3H-34-700/-700A 334198 L : O.E. = GF3H-34-900/-900A 3) 334199 R : O.E. = GF3J-34-700/-700A 334200 L : O.E. = GF3H-34-900/-900A 4) 335028 R : O.E. = GF3H-28-700/-700A 335029 L : O.E. = GF3H-28-900/-900A | | | | | | | | | |
| CX-3 | | | | | | | | | |
| 1.5 SKYACTIV-D (2WD) (4WD) 2.0 SKYACTIV-G (88 kW) (2WD) 2.0 SKYACTIV-G (110 kW) (4WD) Incl. Start-stop function | (DK) | 2.15 - | | 3340139 L 3340138 R | | | 3430037 | | |
| | | | | | | | | | |
| 1.8 SKYACTIV-D (2WD) (4WD) 2.0 SKYACTIV-G (89 kW) (2WD) | (DK) | 2.18 - | | 3340139 L 3340138 R | | | 3430037 | | |
| | | | | | | | | | |
| CX-5 | | | | | | | | | |
| 2.0 (kW : 110, 114, 121) (2WD) (KE, GH) 2.0 (kW : 110, 113, 118) (4WD) 2.2 D (110 kW) (2WD) (4WD) 2.2 D (129 kW, = SHY4) (4WD) Incl. | (KE, GH) | 11.11 - 2.17 | | 339337 L 339336 R | | | 349219 | | |
| | | | | | | | | | |
| 2.5 (141 kW) (4WD) (KE, GH) | (KE, GH) | 2.15 - 2.17 | | 339337 L 339336 R | | | 3440013 | | |
| | | | | | | | | | |
| 2.0 (kW : 110, 118, 121) (2WD) (4WD) (KF) 2.0 SKYACTIV-G (2WD) (4WD) 2.5 (143 kW) (2WD) 2.5 (143 kW) (4WD) 2.2 D (110 kW, 135 kW) (2WD) (4WD) 2.2 D (129 kW, = SHY6) (4WD) | (KF) | 5.17 - 3.18 - 5.17 - 10.18 5.17 - 5.17 - 5.17 - | | | | | 3440013 | | |
| | | | | | | | | | |
| 2.5 (143 kW) (2WD) (KF) | (KF) | 11.18 - | | | | | 3440014 | | |
| | | | | | | | | | |
| 1) 2.0 SKYACTIV-G (2WD) (4WD), 2.5 (143 kW) (2WD) | | | | | | | | | |
| CX-7 | | | | | | | | | |
| | (ER) | 11.06 - | | 339156 L 339155 R | | | 349076 | | |
| | | | | 910325 SM5692 | | | SM5058 | | |
| CX-9 | | | | | | | | | |
| | (TB) | 1.07 - | | 339141 L 339140 R | | | 349070 | | |
| | | | | 910325 SM5692 | | | | | |



| MODEL FAHRZEUG MODELE | YEAR JAHR ANNEE | FRONT/VORNE/AVANT | | | | REAR/HINTEN/ARRIERE | | | |
|---|-----------------------|-----------------------------|-----------------------------|---|--|-----------------------------|-----------------------------|--------------------------------|--------|
| | | PREMIUM Twin-tube Oil | EXCEL-G Twin-tube Gas | GAS-A-JUST Mono-tube Gas | | PREMIUM Twin-tube Oil | EXCEL-G Twin-tube Gas | GAS-A-JUST Mono-tube Gas | |
| Mazda (J) | | | | | | | | | |
| CX-9 | | | | | | | | | |
| 2.5 T (4WD) | (TC) | 6.16 - | | | | | | | SM5890 |
| Demio | | | | | | | | | |
| ALL Incl. High Power Exclusive, ABS | (DW) | 8.98 - 12.99 | | 333267 L 333266 R | | | 341252 | | |
| ALL Incl. High Power Exclusive, ABS | (DW) | 1.00 - 12.02 | | 333267 L 333266 R | | | 341323 | | |
| Familia Presto , Rotary Coupé | | | | | | | | | |
| (SPC, STB, SPVC, STBV) 1000, 1300 (M 10C, FA3T series) | | 2.72 - 2.76 | | | | 443081 ▼ | | 553039 | |
| Luce, 929 L, 929 Exc. | | | | | | | | | |
| 2000, 2000 Turbo (EG i type) (HBSN 2, HBSHE) | | 8.81 - 9.86 | | | | | | 913121 | |
| Mazda 2, Demio | | | | | | | | | |
| ALL With round spring | (DY) | 1.03 - 12.03 | | 333401 L 333400 R | | | | 553308 | |
| | | | | 910017 SM1210 | | | 915400 SM9202 | | |
| ALL With oval spring | (DY) | 1.04 - 9.07 | | 333384 L 333383 R | | | | 553308 | |
| | | | | 910017 SM1210 | | | 915400 SM9202 | | |
| ALL | (DE) | 10.07 - | | 333495 L 333494 R | | | | 553379 | |
| | | | | 910140 SM1550 | | | 915400 SM5802 | | |
| ALL Exc. Hybrid | (DL, DJ) | 8.14 - | | 3330084 L 3330083 R | | | 3430045 ◇ | | |
| Mazda 3 | | | | | | | | | |
| ALL Exc. 2.3 MZR | (BK) | 11.03 - 12.08 | | 334701 L 334700 R | | | 343412 | | |
| | | | | 910026 ¹⁾ SM5589 ²⁾ | | | 915400 SM9203 ▼ | | |
| 1.6 , 1.6 CiTD 2.0, 2.2 CiTD 2.2 CiTD 2.3 MPS 2.0 MZR DiSi | (BL) | 12.08 - 1.09 - 5.09 - | | 334701 L 334700 R | | | 343413 | | |
| | | | | 910139 SM5589 | | | | | |
| 1) 03 - 08 : Exc. 2.3 MPS 2) 03 - 08 : Incl. 2.3 MZR | | | | | | | | | |
| Mazda 3 (BM, BN) | | | | | | | | | |
| (2WD) 1.5 (74 kW, 88 kW) Exc. Start-Stop function | (BM, BN) | 9.13 - | | 338088 L 338087 R | | | 3430041 | | |
| | | | | SM1046 | | | | | |



| MODEL FAHRZEUG MODELE | YEAR JAHR ANNEE | FRONT/VORNE/AVANT | | | | REAR/HINTEN/ARRIERE | | | |
|---|-----------------------|-----------------------------|-----------------------------|--------------------------------|--|-----------------------------|-----------------------------|--------------------------------|--|
| | | PREMIUM Twin-tube Oil | EXCEL-G Twin-tube Gas | GAS-A-JUST Mono-tube Gas | | PREMIUM Twin-tube Oil | EXCEL-G Twin-tube Gas | GAS-A-JUST Mono-tube Gas | |
| Mazda (J) | | | | | | | | | |
| Mazda 3 (BM, BN) | | | | | | | | | |
| (2WD) 1.5 (74 kW, 88 kW) ⊕ Start-Stop function | (BM, BN) | 9.13 - | | 3340036 L 3340035 R | | | 3430041 | | |
| (2WD) 1.6 (77 kW) | (BM, BN) | 9.13 - | | 338088 L 338087 R | | | 3430041 | | |
| (2WD) 2.0 (kW : 88, 110, 121) 1.5 D, 2.2 D (110 kW) | (BM, BN) | 7.13 - | | 3340036 L 3340035 R | | | 3430041 | | |
| Mazda 5 | | | | | | | | | |
| 1.8 i 2.0 i 2.0 CD (81 kW, 105 kW) | (CR19) | 6.05 - | | 334701 L 334700 R | | | | 551105 | |
| ALL | (CW) | 9.10 - | | 339821 L 339820 R | | | | 551105 | |
| Mazda 6 | | | | | | | | | |
| (2WD) ALL Exc. | (GG/GY) | 6.02 - 5.03 | | 341352 L 341351 R | | | 344363 | | |
| (2WD) ALL Exc. | (GG/GY) | 6.03 - 7.07 | | 341352 L 341351 R | | | 344363 | | |
| (2WD) ALL ⊕ | (GG/GY) | 6.02 - 7.07 | | 341333 L 341332 R | | | 344363 | | |
| (4WD) ALL Exc. | (GG/GY) | 8.02 - 7.07 | | 341333 L 341332 R | | | | | |
| (2WD) 1.8 MZR, 2.0 MZR, 2.0 MZR-CD 2.5 MZR, 2.2 MZR-CDi, 2.2 D | (GH) | 8.07 - | | 341450 L 341449 R | | | 349063 ³⁾ | | |
| (4WD) 1.8 MZR, 2.0 MZR, 2.0 MZR-CD 2.5 MZR Incl. (J) | (GH) | 8.07 - | | 341452 L▼ 341451 R▼ | | | 349064▼ | | |
| ALL | (GJ) | 12.12 - 5.13 | | 339405 L 339404 R | | | 349246 ⁴⁾ | | |
| ALL | (GJ) | 5.13 - | | 339405 L 339404 R | | | | | |
| 1) 6.02 - 2.04 2) Exc. (J) 3) Exc. 7.08 - 4) Exc. (ALGV10) 5) ⊕ | | | | | | | | | |



| MODEL FAHRZEUG MODELE | YEAR JAHR ANNEE | FRONT/VORNE/AVANT | | | | REAR/HINTEN/ARRIERE | | | |
|---|-----------------------|-----------------------------|-----------------------------|--------------------------------|--|-----------------------------|-----------------------------|--------------------------------|--|
| | | PREMIUM Twin-tube Oil | EXCEL-G Twin-tube Gas | GAS-A-JUST Mono-tube Gas | | PREMIUM Twin-tube Oil | EXCEL-G Twin-tube Gas | GAS-A-JUST Mono-tube Gas | |
| Mazda (J) | | | | | | | | | |
| MPV | | | | | | | | | |
| (LV52) 3.0 | 93 - 99 | 635010 L 635009 R | | | | 445028 | | | |
| (LV12) 2.5 TD, 3.0 | 93 - 99 | 635010 L 635009 R | | | | 445028 | | | |
| (LW) | 99 - 3.02 | | 334283 L 334282 R | | | | 345024 | | |
| 2.3 i 2.0 DiTD 3.0 V6 | (LW) 3.02 - 2.06 | | 334419 L 334418 R | | | | 345024 | | |
| MX-3 | | | | | | | | | |
| 1.6 16V, 1.9 V6 Incl. ABS | (EC) 91 - 97 | | 333251 L 333250 R | | | | 333253 L 333252 R | | |
| | | | | SM5305 | | | | SM5046 | |
| MX-5 | | | | | | | | | |
| 1600, 1900 Incl. ABS | (NA) 9.89 - 98 | | 341143 | | | | 341127 | | |
| | | | | SM5077 | | | | SM5077 | |
| 1.6 16V, 1.8, 1.8 16V, 1.9 16V Incl. ABS, Sport sus. Exc. Limited edition | (NB) 1.98 - 12.05 | | 341253 | | | | 341254 | | |
| | | | | SM5139 | | | | SM5139 | |
| Limited edition 1.6 16V, 1.9 16V Incl. ABS | (NB) 5.98 - 12.05 | | | OE = NC12-34-700C/D | | | | OE = NC12-34-700C/D | |
| 1.8, 2.0 Exc. 2.0 Expression | (NC) 3.05 - | | | 551117 ¹⁾ | | | | 551118 ²⁾ | |
| | | | | SM5620 | | | | SM5620 | |
| 1) Exc. OE = NF53-34-700B | | 2) Exc. OE = NF53-28-700B | | | | | | | |
| MX-6 | | | | | | | | | |
| 2000, 2500 Exc. | (GE 6) 7.91 - 97 | 634045 L 634044 R | 334083 L 334082 R | | | 634046 | 334084 | | |
| | | | | SM5308 | | | | SM5093 L▼ SM5094 R▼ | |
| 2500 Exc. | (GE 6) 7.91 - 97 | 634045 L 634044 R | 334083 L 334082 R | | | | 334085▼ | | |
| | | | | SM5308 | | | | SM5093 L▼ SM5094 R▼ | |
| Premacy | | | | | | | | | |
| 1.9, 2.0, 2.0 TD | (CP) 7.99 - 6.01 | | 333269 L 333268 R | | | | 334260 L 334259 R | | |
| | | | | 910025 | | | | | |
| 1.9, 2.0, 2.0 TD | (CP) 7.01 - 3.05 | | 333351 L 333350 R | | | | 334260 L 334259 R | | |
| | | | | 910025 | | | | | |



| MODEL FAHRZEUG MODELE | YEAR JAHR ANNEE | FRONT/VORNE/AVANT | | | | REAR/HINTEN/ARRIERE | | | | |
|-----------------------------|-----------------------|---------------------------------|-----------------------------|--------------------------------|------------------------|-----------------------------|-----------------------------|--------------------------------|--------|--|
| | | PREMIUM Twin-tube Oil | EXCEL-G Twin-tube Gas | GAS-A-JUST Mono-tube Gas | | PREMIUM Twin-tube Oil | EXCEL-G Twin-tube Gas | GAS-A-JUST Mono-tube Gas | | |
| Mazda (J) | | | | | | | | | | |
| RX-8 | | | | | | | | | | |
| 2.6 (141 kW, 170 kW) | (SE17) | 10.03- 6.12 | | | 551115 | | | | 551116 | |
| | | | | SM5620 | | | | SM5620 | | |
| Savanna RX 7 | | | | | | | | | | |
| Exc. | (FC) | 85 - 92 | | | 334130 L▼ 334129 R▼ | | | | | |
| Tribute | | | | | | | | | | |
| | | 3.00 - 5.08 | | | 334334 L 334333 R | | | 344356 | | |
| Xedos 6 | | | | | | | | | | |
| | (CA) | 92 - 99 | | | 334280 L 334279 R | | | 334281 | | |
| Xedos 9 | | | | | | | | | | |
| | (TA) | 7.93 - 00 | | | | | | 341259 | | |
| Mazda Commercial (J) | | | | | | | | | | |
| BT-50 | | | | | | | | | | |
| ⊖ High Rider | (CD) | 12.06- | | | 340015 | | | 340016 | | |
| ⊕ High Rider | (CD) | 12.06- | | | 340023 | | | 345077 | | |
| E Series / Bongo | | | | | | | | | | |
| Bongo (FSA, FPA) | | 66 - 77 | 443085 | | 553085 | | | | | |
| E1400, E1800 | | 84 - 4.97 | 443215 | 343215 | | | 443179 | 343214▼ | | |
| E2000, E2200 D ⊕ | | 84 - 4.97 | 443215 | 343215 | | | 443179 | 343214▼ | | |
| | | O.E. = S083 28 700, S280 28 700 | | | | | | | | |
| E2000, E2200 D ⊕ | | 84 - 4.97 | 443215 | 343215 | | | 443285 | | 553193 | |
| | | O.E. = S085 28 700 | | | | | | | | |
| E2000, E2200 | | 84 - 4.97 | 444144 | 344278▼ | | | 443179 | 343214▼ | | |
| E2000, E2200 | | 3.97 - 99 | 443215 | 343215 | | | 443179 | 343214▼ | | |



| MODEL FAHRZEUG MODELE | YEAR JAHR ANNEE | FRONT/VORNE/AVANT | | | | REAR/HINTEN/ARRIERE | | | |
|--|-----------------------|-----------------------------|-----------------------------|--------------------------------|--|-----------------------------|-----------------------------|--------------------------------|--|
| | | PREMIUM Twin-tube Oil | EXCEL-G Twin-tube Gas | GAS-A-JUST Mono-tube Gas | | PREMIUM Twin-tube Oil | EXCEL-G Twin-tube Gas | GAS-A-JUST Mono-tube Gas | |
| Mazda Commercial (J) | | | | | | | | | |
| E Series / Bongo | | | | | | | | | |
| E2000, E2200 | 3.97 - 99 | 443215 | 343215 | | | | | | |
| E2000, E2200 | 3.97 - 99 | 443215 | 343215 | | | | | | |
| E2000, E2200 | 3.97 - 99 | 444144 | 344278▼ | | | 443179 | 343214▼ | | |
| E2000, E2200 | 3.97 - 99 | 444144 | 344278▼ | | | | | | |
| E2000, E2200 | 3.97 - 99 | 444144 | 344278▼ | | | | | | |
| Pick Up | | | | | | | | | |
| 800, 1000, 1200 (SSA, BSA 55, SPA, BP, BTA) | 63 - 73 | 443085 | | 553085 | | 443081▼ | | 553039 | |
| 1300 (FA2T) | 12.75 - 80 | 443085 | | 553085 | | 443081▼ | | 553039 | |
| Proceed / B Series | | | | | | | | | |
| Proceed 1500 (BUD 61) | 65 - 71 | 443085 | | 553085 | | 443081▼ | | | |
| Proceed 1600 (BNA 61) | 71 - 76 | | | | | 443081▼ | | | |
| Proceed 1300, 1800 (BTA 67, PE 2 V 6) | 72 - 89 | | | 553086▼ | | 443081▼ | | | |
| (UF) B 1600, B 2000, B 2200, B 2600, 2.5 D | 1.85 - 1.99 | 443216 | 343324▼ | 553171 | | 443259 | 343252▼ | 553209 | |
| (UF) B 1600, B 2000, B 2200, B 2600, 2.5 D | 1.85 - 1.99 | 444135 | 344305 | 554100 | | 444136 | 344304 | 554101 | |
| B 2200 B 2500 2.5 D | (UN) 2.99 - 7.06 | | 343324▼ | 553171 | | | 343326 | | |
| B 2500 B 2200 B 2600 | (UN) 2.99 - 7.06 | | 344305 | 554100 | | | 344304 | 554101 | |
| T Series | | | | | | | | | |
| Titan Cabin (TA 2 series) | 77 - | | | | | 444025 | | | |



| MODEL FAHRZEUG MODELE | YEAR JAHR ANNEE | FRONT/VORNE/AVANT | | | | REAR/HINTEN/ARRIERE | | | |
|---|----------------------------|-----------------------------|-----------------------------|--------------------------------|--|-----------------------------|-----------------------------|--------------------------------|--|
| | | PREMIUM Twin-tube Oil | EXCEL-G Twin-tube Gas | GAS-A-JUST Mono-tube Gas | | PREMIUM Twin-tube Oil | EXCEL-G Twin-tube Gas | GAS-A-JUST Mono-tube Gas | |
| Mercedes Benz (D) | | | | | | | | | |
| 190 Series (W201) | | | | | | | | | |
| 190, 190 E, 190 D (W201) Exc. 190 E 2.3-16, 2.5-16, Sport sus. | 12.82- 93 | | 334017 324007▼ | | | | | 553177 243032 | |
| | | 915124 | SM1100 | | | | | | |
| 190 E 2.3 16V 190 E 2.5 16V (W201) | 9.83- 89 9.88- 5.93 | | 324007▼ | | | | | | |
| | | 915124 | SM1100 | | | | OE = | | |
| ⊕ Sport sus. Exc. 190 E 2.3 16V, 2.5 16V (W201) | 12.82- 93 | | 324007▼ | | | | | 243032 | |
| | | 915124 | SM1100 | | | | | | |
| A-Class (W168) | | | | | | | | | |
| A 140, A 160 (W168) A 190, A 210, A 160 CDI, A 170 CDI Exc. Sport sus., | 7.97- 8.04 6.98- 8.04 | | 333614 | | | | | 553604 | |
| | | 910098 | SM1056 | | | | | | |
| A 140, A 160 (W168) A 190, A 160 CDI, A 170 CDI ⊕ Sport sus. Exc. | 7.97- 10.01 6.98- 10.01 | | 333614 | | | | | 553604 ¹⁾ | |
| | | 910098 | SM1056 | | | | | | |
| 1) 553604 : ⊕ Sport sus. : - Exc. A 190, A 160 CDI, A 170 CDI - A 140, A 160 : 6.98 → | | | | | | | | | |
| A-Class (W169) | | | | | | | | | |
| A 150, A 160, A 170, A 180 (W169) A 200, A 200 Turbo, E-Cell A 160 CDI, A 180 CDI, A 200 CDI Incl. , , , Comfort sus. Exc. Sport sus. | 7.04- 6.12 | | 339852 | | | | | 553340 ¹⁾ | |
| | | 910208 | SM5785 | | | | | SM1548 | |
| 1) Incl. Sport sus. | | | | | | | | | |
| A-Class (W176) | | | | | | | | | |
| (W176) Incl. Sport sus. Exc. Comfort sus., , Exc. Sport edition, AMG, Urban Turbo | 6.12- 5.18 | | 3348063 L 3348062 R | | | | | 5538001 | |
| | | 910274 ¹⁾ | SM1053 ²⁾ | | | | | | |
| (W176) ⊕ Comfort sus. Exc. Sport sus., , Exc. AMG, Urban Turbo | 6.12- 5.18 | | 3348061 L 3348060 R | | | | | 5538002 | |
| | | 910275 | SM1053 ²⁾ | | | | | | |
| (W176) ⊕ Exc. Sport sus., Comfort sus., Exc. AMG, Urban Turbo | 6.12- 5.18 | | 3348065 L 3348064 R | | | | | | |
| | | 910275 | SM1053 ²⁾ | | | | | | |
| 1) Incl. AMG, Sport edition, 2) Incl. | | | | | | | | | |



Mercedes

| MODEL FAHRZEUG MODELE | YEAR JAHR ANNEE | FRONT/VORNE/AVANT | | | | REAR/HINTEN/ARRIERE | | | |
|-----------------------------|-----------------------|-----------------------------|-----------------------------|--------------------------------|--|-----------------------------|-----------------------------|--------------------------------|--|
| | | PREMIUM Twin-tube Oil | EXCEL-G Twin-tube Gas | GAS-A-JUST Mono-tube Gas | | PREMIUM Twin-tube Oil | EXCEL-G Twin-tube Gas | GAS-A-JUST Mono-tube Gas | |

Mercedes Benz (D)

B-Class (W245)

| | | | | | | | | | |
|---|--------|--|--------|--|--------|--|--|----------------------|----------------------|
| B 150, B 160, B 170, B 170 LPG (W245) B 180, B 180 LPG, B 200, B 200 Turbo B 180 CDI, B 200 CDI Incl. Exc. Sport sus. | 3.05 - | | 339853 | | | | | 553340 ¹⁾ | |
| | | | 910208 | | SM5785 | | | | SM1548 ¹⁾ |

1) Incl. Sport sus.

B-Class (W246, W242)

| | | | | | | | | | |
|---|---------------|--|------------------------|--|----------------------|--|--|---------|--|
| (W246, W242) Exc. Sport sus., Comfort sus., , Exc. Electric Drive, Flexfuel, Natural Gas Drive | 11.11 - 12.18 | | 3348063 L 3348062 R | | | | | 5538001 | |
| | | | 910274 ¹⁾ | | SM1053 ²⁾ | | | | |
| B 180, B 200, B 220 (W246, W242) B 180 CDI (= OM 651.901) B 200 CDI, B 220 CDI / d (120 kW, 125 kW) Sport sus. Exc. Comfort sus., , | 11.11 - 12.18 | | | | | | | 5538001 | |
| | | | 910274 ¹⁾ | | SM1053 ²⁾ | | | | |
| (W246, W242) Comfort sus. Exc. Sport sus., , Exc. Electric Drive, Flexfuel, Natural Gas Drive | 11.11 - 12.18 | | 3348061 L 3348060 R | | | | | 5538002 | |
| | | | 910275 | | SM1053 ²⁾ | | | | |
| (W246, W242) Exc. Sport sus., Comfort sus., Exc. Electric Drive, Flexfuel, Natural Gas Drive | 11.11 - 12.18 | | 3348065 L 3348064 R | | | | | | |
| | | | 910275 | | SM1053 ²⁾ | | | | |

1) Incl.

2) Incl. Electric Drive, Flexfuel, Natural Gas Drive,

C-Class (202)

| | | | | | | | | | |
|--|-------------|--|--|--------|----------------------|--|--|----------------|--|
| (W202) C 180, C 200, C 220, C 280 C 200 Kompressor C 200 D, C 220 D, C 250 D, C 200 CDI C 230, C 230 Kompressor, C 240, C 250 TD C 220 CDI Exc. Esprit, Sport sus. | 3.93 - 5.00 | | | 553183 | | | | 553185 Exc. | |
| | | | | | SM1548 ¹⁾ | | | | |
| (W202) C 180, C 200, C 220, C 280, C 200 Kompressor C 200 D, C 220 D, C 250 D, C 200 CDI C 230, C 230 Kompressor, C 240, C 250 TD C 220 CDI Esprit, Sport sus. | 3.93 - 5.00 | | | 553184 | | | | 553186 Exc. | |
| | | | | | SM1548 ¹⁾ | | | | |

1) A186648 → , F135060 →



| MODEL FAHRZEUG MODELE | YEAR JAHR ANNEE | FRONT/VORNE/AVANT | | | | REAR/HINTEN/ARRIERE | | | |
|---|-----------------------|-----------------------------|-----------------------------|--------------------------------|--|-----------------------------|-----------------------------|--------------------------------|--|
| | | PREMIUM Twin-tube Oil | EXCEL-G Twin-tube Gas | GAS-A-JUST Mono-tube Gas | | PREMIUM Twin-tube Oil | EXCEL-G Twin-tube Gas | GAS-A-JUST Mono-tube Gas | |
| Mercedes Benz (D) | | | | | | | | | |
| C-Class (202) | | | | | | | | | |
| (S202) C 180, C 200, C 230, C 240, C 280 C 200 Kompressor C 200 D/CDi, C 220 D/CDi, C 250 TD C 230 Kompressor Incl. Sport sus., Esprit | 6.96 - 3.01 | | | 553184 | | | | 553185 Exc. | |
| 1) A186648 →, F135060 → | | | | | | | | | |
| C-Class (203) Exc. 4- Matic (4WD) | | | | | | | | | |
| (W203) | 5.00 - 07 | | 335920 | | | | | 553306 | |
| | | 910027 SM1102 | | | | | | | |
| (S203) Exc. | 1.01 - 07 | | 335920 | | | | | 553306 | |
| | | 910027 SM1102 | | | | | | | |
| (CL203) | 3.01 - 6.11 | | 335920 | | | | | 553306 | |
| | | 910027 SM1102 | | | | | | | |
| C-Class (W204) | | | | | | | | | |
| Incl. Sport sus., Exc. AMG | (W204) 1.07 - | | | | | | | 553381 | |
| | | | | | | 910141 ¹⁾ SM9907 | | | |
| Exc. AMG | (W204) 1.07 - | | | | | | | 553384 | |
| | | | | | | SM9907 | | | |
| 1) Exc. Sport sus. | | | | | | | | | |
| C-Class (S204) | | | | | | | | | |
| Incl. Sport sus., Exc. AMG | (S204) 8.07 - | | | | | | | 553381 | |
| | | | | | | 910141 ¹⁾ SM9907 | | | |
| Exc. AMG | (S204) 8.07 - | | | | | | | 553384 | |
| | | | | | | SM9907 | | | |
| 1) Exc. Sport sus. | | | | | | | | | |
| C-Class (C204) | | | | | | | | | |
| Incl. Sport sus. Exc. AMG | (C204) 6.11 - | | | | | | | 553381 | |
| | | | | | | SM9907 | | | |
| C-Class (205) | | | | | | | | | |
| Sport sus., Exc. , , Comfort sus., Semi-active sus. | (W205, S205) 12.13 - | | | | | | | 553384 | |



| MODEL FAHRZEUG MODELE | YEAR JAHR ANNEE | FRONT/VORNE/AVANT | | | | REAR/HINTEN/ARRIERE | | | |
|-----------------------------|-----------------------|-----------------------------|-----------------------------|--------------------------------|--|-----------------------------|-----------------------------|--------------------------------|--|
| | | PREMIUM Twin-tube Oil | EXCEL-G Twin-tube Gas | GAS-A-JUST Mono-tube Gas | | PREMIUM Twin-tube Oil | EXCEL-G Twin-tube Gas | GAS-A-JUST Mono-tube Gas | |

Mercedes Benz (D)

CLA-Class (C117)

| | | | | | | | | | |
|--|--------|-------------|--|------------------------|--|--------|--|---------|------|
| (2WD) (4WD) Incl. Sport sus. Exc. Comfort sus., , Exc. Sport edition, AMG | (C117) | 1.13 - 3.19 | | 3348063 L 3348062 R | | | | 5538001 | |
| | | | | 910274 ¹⁾ | | SM1053 | | | |
| (2WD) (4WD) ⊕ Comfort sus. Exc. Sport sus., , Exc. AMG | (C117) | 1.13 - 3.19 | | 3348061 L 3348060 R | | | | 5538002 | |
| | | | | 910275 | | SM1053 | | | |
| (2WD) (4WD) ⊕ Exc. Sport sus., Comfort sus., Exc. AMG | (C117) | 1.13 - 3.19 | | 3348065 L 3348064 R | | | | | |
| | | | | 910275 | | SM1053 | | | |

1) Incl. AMG, Sport edition,

CLA-Class Shooting Brake (X117)

| | | | | | | | | | |
|--|--------|-------------|--|------------------------|--|----------------------|--|---------|------|
| (2WD) (4WD) Incl. Sport sus. Exc. Comfort sus., , Exc. Sport edition, AMG | (X117) | 1.15 - 3.19 | | 3348063 L 3348062 R | | | | 5538001 | |
| | | | | 910274 ¹⁾ | | SM1053 ³⁾ | | | |
| (2WD) (4WD) ⊕ Comfort sus. Exc. Sport sus., , Exc. AMG | (X117) | 1.15 - 3.19 | | 3348061 L 3348060 R | | | | 5538002 | |
| | | | | 910275 ²⁾ | | SM1053 ³⁾ | | | |
| (2WD) (4WD) ⊕ Exc. Sport sus., Comfort sus., Exc. AMG | (X117) | 1.15 - 3.19 | | 3348065 L 3348064 R | | | | | |
| | | | | 910275 ²⁾ | | SM1053 ³⁾ | | | |

1) Incl. AMG, Sport edition,

2) Incl. AMG

3) Incl. AMG,

Citan → Mercedes Benz Commercial

| | | | | | | | | | |
|--|--|--|--|--|--|--|--|--|--|
| | | | | | | | | | |
|--|--|--|--|--|--|--|--|--|--|

CLK (208) Exc. 4-Matic (4WD)

| | | | | | | | | | | |
|--|-------|-----------|--|--|--------|--|--|--|--------|----------------------|
| CLK 200, CLK 200K, CLK 230K CLK 320, CLK 430 Exc. , Sport sus. | (208) | 6.97 - 02 | | | 553236 | | | | 553238 | |
| | | | | | | | | | Exc. | |
| | | | | | | | | | | SM1548 ¹⁾ |
| | | | | | | | | | | SM1548 ¹⁾ |
| CLK 200, CLK 200K, CLK 230K CLK 320, CLK 430 ⊕ Sport sus. | (208) | 6.97 - 02 | | | 553237 | | | | 553238 | |
| | | | | | | | | | Exc. | |
| | | | | | | | | | | SM1548 ¹⁾ |
| | | | | | | | | | | SM1548 ¹⁾ |

1) : → 2.02

: 6.98 →



| MODEL FAHRZEUG MODELE | YEAR JAHR ANNEE | FRONT/VORNE/AVANT | | | | REAR/HINTEN/ARRIERE | | | | | |
|---|-----------------------|-----------------------------|------------------------------|--------------------------------|--|-----------------------------|-----------------------------|--------------------------------|----------------------|--|--|
| | | PREMIUM Twin-tube Oil | EXCEL-G Twin-tube Gas | GAS-A-JUST Mono-tube Gas | | PREMIUM Twin-tube Oil | EXCEL-G Twin-tube Gas | GAS-A-JUST Mono-tube Gas | | | |
| Mercedes Benz (D) | | | | | | | | | | | |
| CLK (208) Exc. 4- Matic (4WD) | | | | | | | | | | | |
| CLK 200, CLK 200K, CLK 230K CLK 320, CLK 430 Exc. Sport sus. | (208) | 6.97 - 02 | | 553236 | | | | | | | |
| | | | SM1548 ¹⁾ | | | | | | SM1548 ¹⁾ | | |
| 1) : → 2.02 : 6.98 → | | | | | | | | | | | |
| CLK (209) Exc. 4- Matic (4WD) | | | | | | | | | | | |
| (C209) CLK 200 CGI, CLK 200 Kompressor CLK 240, CLK 280, CLK 320, CLK 350 CLK 500, CLK 220 CDI CLK 320 CDI, CLK 270 CDI Exc. , Sport sus. | (C209) | 6.02 - 5.09 | | 335920 | | | | 553366 | | | |
| | | | 910027 SM1102 ¹⁾ | | | | | | | | |
| (C209) CLK 200 CGI, CLK 200 Kompressor CLK 240, CLK 280, CLK 320 CLK 350, CLK 500, CLK 220 CDI CLK 320 CDI, CLK 270 CDI, CLK 55 AMG (Higher sus.) Exc. Sport sus. | (C209) | 6.02 - 5.09 | | | | | | 553366 | | | |
| | | | SM1102 ¹⁾ | | | | | | | | |
| (C209) CLK 200 CGI, CLK 200 Kompressor CLK 240, CLK 280, CLK 320 CLK 350, CLK 500, CLK 220 CDI CLK 320 CDI, CLK 270 CDI Sport sus. Exc. (Higher sus.) | (C209) | 6.02 - 5.09 | | 335932 | | | | 553367 | | | |
| | | | SM1102 ¹⁾ | | | | | | | | |
| (A209) CLK 200 CGI, CLK 200 Kompressor CLK 240, CLK 280, CLK 320 CLK 350, CLK 500, CLK 320 CDI Exc. (Higher sus.), Sport sus. | (A209) | 2.03 - 3.10 | | 335920 | | | | 553366 | | | |
| | | | 910027 SM1102 ¹⁾ | | | | | | | | |
| (A209) CLK 200 CGI, CLK 200 Kompressor CLK 240, CLK 280, CLK 320 CLK 350, CLK 500, CLK 320 CDI CLK 55 AMG Sport sus. Exc. (Higher sus.) | (A209) | 2.03 - 3.10 | | 335932 | | | | 553367 | | | |
| | | | SM1102 ¹⁾ | | | | | | | | |
| (A209) CLK 200 CGI, CLK 200 Kompressor CLK 240, CLK 280, CLK 320 CLK 350, CLK 500, CLK 320 CDI CLK 55 AMG (Higher sus.), Exc. Sport sus. | (A209) | 2.03 - 3.10 | | | | | | 553366 | | | |
| | | | SM1102 ¹⁾ | | | | | | | | |
| 1) Incl. CLK 55 AMG, CLK 63 AMG | | | | | | | | | | | |



Mercedes

| MODEL FAHRZEUG MODELE | YEAR JAHR ANNEE | FRONT/VORNE/AVANT | | | | REAR/HINTEN/ARRIERE | | | |
|--|-----------------------|-----------------------------|-----------------------------|--------------------------------|--|-----------------------------|-----------------------------|--------------------------------|--|
| | | PREMIUM Twin-tube Oil | EXCEL-G Twin-tube Gas | GAS-A-JUST Mono-tube Gas | | PREMIUM Twin-tube Oil | EXCEL-G Twin-tube Gas | GAS-A-JUST Mono-tube Gas | |
| Mercedes Benz (D) | | | | | | | | | |
| CLS-Class (C219) | | | | | | | | | |
| (C219) | 04 - 08 | | | | | | | | |
| | | | | | | | | | |
| CLS-Class (C218) | | | | | | | | | |
| CLS 350, CLS 500, CLS 500 4-matic CLS 63 AMG (386 kW, 410 kW) CLS 63 AMG 4-matic CLS 250 CDI, CLS 350 CDI CLS 350 CDI 4-matic Exc. | (C218) 1.11 - | | | | | | | | |
| | | | | | | | | | |
| CLS-Class (C257) | | | | | | | | | |
| (C257) | 12.17 - | | | | | | | 5530005 | |
| Exc. , , Semi active sus. | | | | | | | | | |
| CLS-Class Shooting Brake (X218) | | | | | | | | | |
| CLS 350, CLS 500 CLS 500 4-matic CLS 63 AMG (386 kW, 410 kW) CLS 63 AMG 4-matic (410 kW) CLS 250 CDI, CLS 350 CDI CLS 350 CDI 4-matic Exc. | (X218) 1.11 - | | | | | | | | |
| | | | | | | | | | |
| E-Class (124) | | | | | | | | | |
| (W124) | 85 - 93 | | 334017 324007▼ | | | | | 553178 243032 | |
| 200, 200 E, 230 E, 260 E, 300 E, 320 E 400 E, 200 D, 250 D, 250 Turbo D, 300 D 300 D-Turbo Exc. 4-Matic , Sport sus. | | | | | | | | Exc. | |
| (C124) | 87 - 93 | | 334017 324007▼ | | | | | 553178 243032 | |
| 230 CE, 300 CE, 320 CE Exc. Sport sus. | | | | | | | | Exc. | |
| (S124) | 85 - 93 | | 334017 324007▼ | | | | | | |
| 200 T, 230 TE, 280 TE, 300 TE, 320 TE 200 TD, 250 TD, 300 TD-Turbo Exc. Sport sus., 4-Matic | | | | | | | | OE = | |
| (W124) | 93 - 95 | | 334017 324007▼ | | | | | 553178 243032 | |
| E200, E220, E280, E320, E420 E200 D, E250 D, E250 D-Turbo, E300 D E300 D-Turbo Exc. 4-Matic , Sport sus. | | | | | | | | Exc. | |
| (C124) | 93 - 95 | | 334017 324007▼ | | | | | 553178 243032 | |
| E220 C, E320 C Exc. Sport sus. | | | | | | | | Exc. | |



| MODEL FAHRZEUG MODELE | YEAR JAHR ANNEE | FRONT/VORNE/AVANT | | | | REAR/HINTEN/ARRIERE | | | |
|--|-----------------------|-----------------------------|-----------------------------|--------------------------------|--|-----------------------------|-----------------------------|--------------------------------|--|
| | | PREMIUM Twin-tube Oil | EXCEL-G Twin-tube Gas | GAS-A-JUST Mono-tube Gas | | PREMIUM Twin-tube Oil | EXCEL-G Twin-tube Gas | GAS-A-JUST Mono-tube Gas | |
| Mercedes Benz (D) | | | | | | | | | |
| E-Class (124) | | | | | | | | | |
| (S124) E200 T, E220 T, E280 T, E320 T E250 TD, E300 TD, E300 TD-Turbo Exc. Sport sus., 4-Matic | 93 - 95 | | 334017 324007▼ | | | | | | |
| | | 915124 | SM1101 | | | | OE = | | |
| (W124, C124) ⊕ Sport sus. Exc. 4-Matic , AMG | 85 - 95 | | 324007▼ | | | | | 243032 Exc. | |
| | | 915124 | SM1101 | | | | | | |
| (S124) ⊕ Sport sus. Exc. 4-Matic , AMG | 85 - 95 | | 324007▼ | | | | | | |
| | | 915124 | SM1101 | | | | OE = | | |
| E-Class (210) | | | | | | | | | |
| (W210) E200, E230, E240, E280, E320, E420 E430, E200 D, E220 D, E250 D, E250 TD E290 TD, E300 TD, E300 D E200 CDI, E220 CDI, E270 CDI, E320 CDI Exc. Avantgarde, Sport sus., , 4-Matic | 6.95 - 3.02 | | | 553197 | | | | 553198 Exc. | |
| | | | | SM1549 | | | | | |
| (W210) E200, E230, E240, E280, E320, E420 E430, E200 D, E220 D, E250 D, E250 TD E290 TD, E300 TD, E300 D E200 CDI, E220 CDI, E270 CDI, E320 CDI ⊕ Sport sus., Avantgarde Exc. , 4-Matic | 6.95 - 3.02 | | | 553199 | | | | 553200 Exc. | |
| | | | | SM1549 | | | | | |
| (S210) E200, E230, E240, E280, E320, E420, E430 E250 D, E250 TD, E290 TD, E270 TCDi E300 TD, E220 CDI, E270 CDI, E320 CDI Exc. Avantgarde, Sport sus., , 4-Matic | 6.95 - 3.02 | | | 553197 | | | | | |
| | | | | SM1549 | | | OE = | | |
| (S210) E200, E230, E240, E280, E320, E420, E430 E250 D, E250 TD, E290 TD, E270 TCDi E300 TD, E220 CDI, E270 CDI, E320 CDI ⊕ Sport sus., Avantgarde Exc. , 4-Matic | 6.95 - 3.02 | | | 553184 | | | | | |
| | | | | SM1549 | | | OE = | | |
| E-Class (211) | | | | | | | | | |
| (W211) E200, E200 CGI, E200 Kompressor E200 NGT, E230, E240, E280 E300 BlueTEC, E320, E350, E350 CGI E500, E55 AMG Kompressor, E63 AMG E200 CDI, E220 CDI, E270 CDI, E280 CDI E320 CDI, E400 CDI, E420 CDI Incl. Avantgarde Exc. , | 3.02 - 12.08 | | | 551926 | | | | 553356 | |
| | | 910165 ¹⁾ | SM5501 | | | | | | |

1) Exc. Sport sus., Avantgarde



| MODEL FAHRZEUG MODELE | YEAR JAHR ANNEE | FRONT/VORNE/AVANT | | | | REAR/HINTEN/ARRIERE | | | |
|--|-----------------------|-----------------------------|-----------------------------|--------------------------------|--|-----------------------------|-----------------------------|--------------------------------|--|
| | | PREMIUM Twin-tube Oil | EXCEL-G Twin-tube Gas | GAS-A-JUST Mono-tube Gas | | PREMIUM Twin-tube Oil | EXCEL-G Twin-tube Gas | GAS-A-JUST Mono-tube Gas | |
| Mercedes Benz (D) | | | | | | | | | |
| E-Class (211) | | | | | | | | | |
| (S211) E200, E200 Kompressor, E200 T Kompressor E230, E240, E320, E350 E55 T AMG Kompressor, E63 AMG E200 CDI, E220 CDI, E270 CDI E320 CDI, E400 CDI, 350 CGI E280 T, E500 T, E280 T CDI Incl. Avantgarde Exc. | 3.03 - 7.09 | | | 551926 | | | 344488 | | |
| | | 910165 ¹⁾ SM5501 | | | | | | | |
| (W211, S211) E240, E240 T, E280, E280 T E320, E320 T, E350, E350 T Exc. | 3.03 - 7.09 | | | | | | | | |
| | | SM1029 L SM1030 R | | | | | | | |
| 1) Exc. Sport sus., Avantgarde | | | | | | | | | |
| E-Class (212) | | | | | | | | | |
| (W212) Incl. Avantgarde, (Self Leveling), Exc. AMG, Sport sus., | 1.09 - | | | | | | | 553388 | |
| | | 910158 SM1103 | | | | | SM9907 | | |
| (W212) Exc. Avantgarde, (Self Leveling), AMG, Sport sus. | 1.09 - | | | | | | | 553381 | |
| | | | | | | | SM9907 | | |
| (S212) Incl. Avantgarde, (Self Leveling), Exc. AMG, Sport sus. | 8.09 - | | | | | | 349138 | | |
| | | 910158 SM1103 | | | | | SM9907 | | |
| (W212, S212) AMG Exc. , Sport sus. | 1.09 - | | | | | | | | |
| | | SM1103 | | | | | SM9907 | | |
| E-Class (A207) | | | | | | | | | |
| (A207) Incl. Sport sus. | 1.10 - | | | | | | | 553381 | |
| | | | | | | | SM9907 | | |
| E-Class (C207) | | | | | | | | | |
| (C207) Incl. Sport sus. | 1.09 - | | | | | | | 553381 | |
| | | | | | | | SM9907 | | |
| E-Class (W213) | | | | | | | | | |
| (W213) Exc. AMG E43, AMG E63 Exc. , Comfort sus., , Semi active sus. | 1.16 - | | | | | | | 5530005 | |



| MODEL FAHRZEUG MODELE | YEAR JAHR ANNEE | FRONT/VORNE/AVANT | | | Wrench icon | REAR/HINTEN/ARRIERE | | | Wrench icon |
|---|-----------------------|-----------------------------|-----------------------------|--------------------------------|-------------|-----------------------------|-----------------------------|--------------------------------|-------------|
| | | PREMIUM Twin-tube Oil | EXCEL-G Twin-tube Gas | GAS-A-JUST Mono-tube Gas | | PREMIUM Twin-tube Oil | EXCEL-G Twin-tube Gas | GAS-A-JUST Mono-tube Gas | |
| Mercedes Benz (D) | | | | | | | | | |
| E-Class (W213) | | | | | | | | | |
| (2WD) (4WD) (W213) ALL + Comfort sus. Exc. AMG E43, AMG E63 Exc. Semi active sus. | 1.16- | | | | | | | 553384 | ⊥ ⊕ |
| E-Class (C238) | | | | | | | | | |
| ALL (2WD) Exc. | (C238) 12.16- | | | | | | | 553381 | ⊥ ⊕ |
| ALL (4WD) + | (C238) 12.16- | | | | | | | 553381 | ⊥ ⊕ |
| ALL (4WD) + | (C238) 12.16- | | | | | | | 553384 | ⊥ ⊕ |
| E-Class (A238) | | | | | | | | | |
| E 300, E 350 EQ Boost, E 220d, E 300d, E 350d E 350d 4-matic, E 400 4-matic Exc. | (A238) 6.17- | | | | | | | 553381 | ⊥ ⊕ |
| (4WD) E 200, E 220d, E 400d AMG E 53 EQ Boost + | (A238) 10.17- | | | | | | | 553381 | ⊥ ⊕ |
| (4WD) E 200, E 220d, E 400d AMG E 53 EQ Boost + | (A238) 10.17- | | | | | | | 553384 | ⊥ ⊕ |
| G-Class (-8.93) | | | | | | | | | |
| 200 GE (460) 85- 90 230 G (460.2) 2.79- 90 230 GE (460.21/23/24) 2.79- 90 230 GE (460.220/221/228) 2.79- 90 240 GD (460.31/320/33/34) 2.79- 90 250 GD (460.31/328/33) 85- 90 280 GE (460) 2.79- 90 300 GD (460.31/322/33/34) 2.79- 90 | | 445029 | | | ⊕ ⊥ | | 445033 | | ⊥ ⊕ |
| 200 GE (463.200/220/221) 90- 8.93 230 GE (463) 90- 8.93 250 GD (463.304/324/325) 90- 8.93 250 GD-TD (463) 9.91- 8.93 290 GD (463) 92- 8.93 300 GD (463.307/327/328) 90- 8.93 300 GE (463.207/227/288) 90- 8.93 300 GD-TD (463.300/320/321) 9.92- 8.93 500 GE (463.228) 90- 8.93 Exc. | | 445030 | | | ⊕ ⊥ | | 445033 | | ⊥ ⊕ |



| Mercedes | MODEL FAHRZEUG MODELE | YEAR JAHR ANNEE | FRONT/VORNE/AVANT | | | | REAR/HINTEN/ARRIERE | | | |
|--------------------------|-----------------------------|-----------------------|-----------------------------|-----------------------------|--------------------------------|----------------------|-----------------------------|-----------------------------|--------------------------------|--|
| | | | PREMIUM Twin-tube Oil | EXCEL-G Twin-tube Gas | GAS-A-JUST Mono-tube Gas | | PREMIUM Twin-tube Oil | EXCEL-G Twin-tube Gas | GAS-A-JUST Mono-tube Gas | |
| Mercedes Benz (D) | | | | | | | | | | |
| G-Class (-8.93) | | | | | | | | | | |
| 200 GE | (463.200/220/221) | 90 - 8.93 | 445032 | | | | 445034 | | | |
| 230 GE | (463) | 90 - 8.93 | | | | | | | | |
| 250 GD | (463.304/324/325) | 90 - 8.93 | | | | | | | | |
| 250 GD-TD | (463) | 9.91 - 8.93 | | | | | | | | |
| 290 GD | (463) | 92 - 8.93 | | | | | | | | |
| 300 GD | (463.307/327/328) | 90 - 8.93 | | | | | | | | |
| 300 GE | (463.207/227/288) | 90 - 8.93 | | | | | | | | |
| 300 GD-TD | (463.300/320/321) | 9.92 - 8.93 | | | | | | | | |
| 500 GE | (463.228) | 90 - 8.93 | | | | | | | | |
| | | | | | | | | | | |
| 230 GE | (460.229) | 2.79 - 90 | 445031 | | | | 445034 | | | |
| 240 GD | (460.321) | 2.79 - 90 | | | | | | | | |
| 250 GD | (460.329) | 85 - 90 | | | | | | | | |
| 250 GD | (461.40) | 90 - 8.93 | | | | | | | | |
| 300 GD | (460.323/325) | 2.79 - 90 | | | | | | | | |
| G-Class (9.93-) | | | | | | | | | | |
| G230 | (461.227) | 9.93 - | 445031 | | | | 445034 | | | |
| G290 D | (461.329) | 9.93 - | | | | | | | | |
| G230 | (463.224/225) | 9.93 - | 445030 | | | | 445033 | | | |
| G230 Cabrio | (463.204) | 9.93 - | | | | | | | | |
| G290 D | (461.328) | 9.93 - | | | | | | | | |
| G290 D | (461.337/338/341) | 9.93 - | | | | | | | | |
| G300 | (463.207/227/228) | 9.93 - | | | | | | | | |
| G300 D | (463.307/327/328) | 9.93 - | | | | | | | | |
| G300 TD | (463) | 10.96 - | | | | | | | | |
| G320 | (463.230/231) | 94 - | | | | | | | | |
| G350 TD | (463.300/320/321) | 9.93 - | | | | | | | | |
| G500 | (463.228) | 9.93 - | | | | | | | | |
| Exc. | | | | | | | | | | |
| G230 | (463.224/225) | 9.93 - | 445032 | | | | 445034 | | | |
| G230 Cabrio | (463.204) | 9.93 - | | | | | | | | |
| G290 D | (461.328) | 9.93 - | | | | | | | | |
| G290 D | (461.337/338/341) | 9.93 - | | | | | | | | |
| G300 | (463.207/227/228) | 9.93 - | | | | | | | | |
| G300 D | (463.307/327/328) | 9.93 - | | | | | | | | |
| G300 TD | (463) | 10.96 - | | | | | | | | |
| G320 | (463.230/231) | 94 - | | | | | | | | |
| G350 TD | (463.300/320/321) | 9.93 - | | | | | | | | |
| G500 | (463.228) | 9.93 - | | | | | | | | |
| | | | | | | | | | | |
| G290 D | (461.323/367/368) | 9.93 - | 445032 | | | | 445034 | | | |
| GLA-Class (X156) | | | | | | | | | | |
| | (X156) | 12.13 - | | 3348065 L 3348064 R | | | | | | |
| | | | | | | | | | | |
| Comfort sus. | | | | | | | | | | |
| Incl. AMG | | | | | | | | | | |
| Exc. Flex, Sports sus., | | | | | | | | | | |
| | | | | 910275 | | SM1053 ¹⁾ | | | | |
| 1) Exc. AMG | | | | | | | | | | |



| MODEL FAHRZEUG MODELE | YEAR JAHR ANNEE | FRONT/VORNE/AVANT | | | | REAR/HINTEN/ARRIERE | | | |
|--|-----------------------|---|-----------------------------|--------------------------------|--------|-----------------------------|-----------------------------|--------------------------------|--|
| | | PREMIUM Twin-tube Oil | EXCEL-G Twin-tube Gas | GAS-A-JUST Mono-tube Gas | | PREMIUM Twin-tube Oil | EXCEL-G Twin-tube Gas | GAS-A-JUST Mono-tube Gas | |
| Mercedes Benz (D) | | | | | | | | | |
| GLK (X204) | | | | | | | | | |
| Exc. Sport sus., , H/D Exc. Comfort sus., , | (X204) | 6.08 - | | 335842 | | | | 553386 SM9907 | |
| Sport sus. Incl. H/D, Comfort sus., , | (X204) | 6.08 - | | 335843 | | | | 5530001 SM9907 | |
| H/D, Comfort sus., Exc. Sport sus., , | (X204) | 6.08 - | | 335842 | | | | 553386 SM9907 | |
| Incl. H/D Exc. Sport sus., H/D, Comfort sus., | (X204) | 6.08 - | | 335842 | | | | 553386 SM9907 | |
| M-Class (W163) | | | | | | | | | |
| ML230 ML320 ML430 ML270 CDI ML350 (180 kW) ML350 (173 kW) ML500 ML400 CDI → A093894 | | 2.98 - 2.98 - 2.98 - 12.99 - 8.02 - 2.03 - 9.01 - 9.01 - | | 349056 | | | | | |
| ML230, ML320, ML350 (173 kW, 180 kW) ML430, ML500 ML270 CDI, ML400 CDI A093894 → → A145272, X707755 | - | | | 349056 | | | | | |
| ML230, ML320, ML350 (173 kW, 180 kW) ML430, ML500 ML270 CDI, ML400 CDI A145273, X707756 → | - 6.05 | | | 349055 | | | | | |
| S Series (W108, W109) | | | | | | | | | |
| 250 S, 280 S, 280 SE, 280 SEL (W108) | | 68 - 8.72 | | | 551016 | | | 554003 | |
| 300 SEB 300 SE (W109) | | 65 - 72 | | | 551016 | | | 554003 | |
| S Series (W116) | | | | | | | | | |
| 280 S, 280 SE, 280 SEL, 350 SE 450 SE, 450 SEL, 450 SEL 6.9 (W116) | | 9.72 - 80 3.73 - 80 | | | 551018 | | | 554004 | |
| S Series (W126) | | | | | | | | | |
| (W126) 280 SE, 280 SEL, 300 SE, 300 SEL 380 SE, 380 SEL, 420 SE, 420 SEL, 500 SE 500 SEL, 560 SE, 560 SEL | | 80 - 91 | | | 551018 | | | 344002 554004 Exc. | |



| MODEL FAHRZEUG MODELE | YEAR JAHR ANNEE | FRONT/VORNE/AVANT | | | | REAR/HINTEN/ARRIERE | | | | | | | | | | | | | | | | | | |
|---|---|-----------------------------|-----------------------------|--------------------------------|--|-----------------------------|-----------------------------|--------------------------------|--|--|------|------|--|-------------|--|-----------------------------|--------------|--|--------------------|--------------|--|--------------|---------------|--|
| | | PREMIUM Twin-tube Oil | EXCEL-G Twin-tube Gas | GAS-A-JUST Mono-tube Gas | | PREMIUM Twin-tube Oil | EXCEL-G Twin-tube Gas | GAS-A-JUST Mono-tube Gas | | | | | | | | | | | | | | | | |
| Mercedes Benz (D) | | | | | | | | | | | | | | | | | | | | | | | | |
| S Series (W126) | | | | | | | | | | | | | | | | | | | | | | | | |
| 380 SEC, 500 SEC (C126) | 9.81 - 6.91 | | | 551017 | | | | 554004 | | | | | | | | | | | | | | | | |
| SL Series (W107, R107, C107) | | | | | | | | | | | | | | | | | | | | | | | | |
| 280 SL, 280 SLC 350 SL, 350 SLC 350 SL 4.5, 350 SLC 4.5 450 SL, 450 SLC | 74 - 85 10.71 - 85 72 - 2.73 74 - 85 | | | 551017 | | | | 554004 | | | | | | | | | | | | | | | | |
| SLC (R172) | | | | | | | | | | | | | | | | | | | | | | | | |
| Incl. Sport sus. Exc. | (R172) 1.16 - | | | | | | | 5530009 | | | | | | | | | | | | | | | | |
| SM1548 | | | | | | | | | | | | | | | | | | | | | | | | |
| SLK (R170) | | | | | | | | | | | | | | | | | | | | | | | | |
| SLK 200, SLK 200 K, SLK 230 K (R170) | 9.96 - 4.04 | | | 553237 | | | | 553245 | | | | | | | | | | | | | | | | |
| SM1548 ¹⁾ | | | | | | | | | | | | | | | | | | | | | | | | |
| 320, 32 AMG K Exc. | (R170) 3.00 - 12.03 | | | | | | | | | | | | | | | | | | | | | | | |
| SM1548 ¹⁾ | | | | | | | | | | | | | | | | | | | | | | | | |
| 1) <table border="1" style="width: 100%; border-collapse: collapse;"> <thead> <tr> <th></th> <th>Date</th> <th>Exc.</th> </tr> </thead> <tbody> <tr> <td>SLK 200, SLK 200 K (141 kW), SLK 230 K (142 kW)</td> <td>9.96 → 3.00</td> <td></td> </tr> <tr> <td>SLK 230 K (145 kW), SLK 320</td> <td>3.00 → 12.03</td> <td></td> </tr> <tr> <td>SLK 200 K (120 kW)</td> <td>4.00 → 12.03</td> <td></td> </tr> <tr> <td>SLK 32 AMG K</td> <td>10.01 → 12.03</td> <td></td> </tr> </tbody> </table> | | | | | | | | | | | Date | Exc. | SLK 200, SLK 200 K (141 kW), SLK 230 K (142 kW) | 9.96 → 3.00 | | SLK 230 K (145 kW), SLK 320 | 3.00 → 12.03 | | SLK 200 K (120 kW) | 4.00 → 12.03 | | SLK 32 AMG K | 10.01 → 12.03 | |
| | Date | Exc. | | | | | | | | | | | | | | | | | | | | | | |
| SLK 200, SLK 200 K (141 kW), SLK 230 K (142 kW) | 9.96 → 3.00 | | | | | | | | | | | | | | | | | | | | | | | |
| SLK 230 K (145 kW), SLK 320 | 3.00 → 12.03 | | | | | | | | | | | | | | | | | | | | | | | |
| SLK 200 K (120 kW) | 4.00 → 12.03 | | | | | | | | | | | | | | | | | | | | | | | |
| SLK 32 AMG K | 10.01 → 12.03 | | | | | | | | | | | | | | | | | | | | | | | |
| SLK (R171) | | | | | | | | | | | | | | | | | | | | | | | | |
| Exc. 55 AMG (R171) | 3.04 - 2.11 | | | | | | | 553359 | | | | | | | | | | | | | | | | |
| SM1031 ¹⁾ | | | | | | | | | | | | | | | | | | | | | | | | |
| SM1548 ²⁾ | | | | | | | | | | | | | | | | | | | | | | | | |
| 1) Incl. 55 AMG 2) SLK 200 K (135 kW), SLK 300, SLK 350 (224 kW), 55 AMG (265 kW) : 1.08 → 1.11 | | | | | | | | | | | | | | | | | | | | | | | | |
| SLK (R172) | | | | | | | | | | | | | | | | | | | | | | | | |
| Incl. Sport sus. Exc. | (R172) 2.11 - | | | | | | | 5530009 | | | | | | | | | | | | | | | | |
| SM1548 | | | | | | | | | | | | | | | | | | | | | | | | |
| V-Class (638/2) | | | | | | | | | | | | | | | | | | | | | | | | |
| Exc. | (638/2) 2.96 - 7.03 | | | 334620 | | | | 343305 | | | | | | | | | | | | | | | | |
| SM5499 | | | | | | | | | | | | | | | | | | | | | | | | |
| 913112 | | | | | | | | | | | | | | | | | | | | | | | | |
| Viano (W639) | | | | | | | | | | | | | | | | | | | | | | | | |
| 3.0, 3.2, 3.5, 3.7 2.0 CDI, 2.2 CDI, 3.0 CDI Exc. | (W639) 9.03 - 8.10 | | | 335931 | | | | 553337 | | | | | | | | | | | | | | | | |
| SM1007 | | | | | | | | | | | | | | | | | | | | | | | | |
| 910113 | | | | | | | | | | | | | | | | | | | | | | | | |



| MODEL FAHRZEUG MODELE | YEAR JAHR ANNEE | FRONT/VORNE/AVANT | | | | REAR/HINTEN/ARRIERE | | | |
|---|----------------------------------|---|-----------------------------|--------------------------------|--------|-----------------------------|-----------------------------|--------------------------------|--------|
| | | PREMIUM Twin-tube Oil | EXCEL-G Twin-tube Gas | GAS-A-JUST Mono-tube Gas | | PREMIUM Twin-tube Oil | EXCEL-G Twin-tube Gas | GAS-A-JUST Mono-tube Gas | |
| Mercedes Benz (D) | | | | | | | | | |
| Viano (W639) | | | | | | | | | |
| (2WD) 3.0, 3.2, 3.5, 3.7 2.0 CDI, 2.2 CDI, 3.0 CDI Exc. , | (W639) | 9.03 - 8.10 | | 335931 | | | | 553338 | |
| | | | | 910113 | | | | SM1007 | |
| (2WD) 3.0, 3.2, 3.5, 3.7 2.0 CDI, 2.2 CDI, 3.0 CDI | (W639) | 9.03 - 8.10 | | 335931 | | | | 553337 | |
| | | | | 910113 | | | | SM1007 | |
| (2WD) 3.0, 3.2, 3.5 2.0 CDI, 2.2 CDI, 3.0 CDI Incl. Sport sus., Comfort sus. | (W639) | 9.10 - | | 3358026 | | | | | |
| | | | | | | | | SM1006 | |
| (4WD) 2.0 CDI, 2.2 CDI | (W639) | 7.05 - 8.10 | | | | | | 553337 | |
| | | | | 910113 | | | | SM1007 | |
| W Series (W110, W111) | | | | | | | | | |
| 220 B, 220 SB 220 SEB / Coupé & Cabrio 190 C, 190 DC 230, 230 S 200, 200 D | (W 111) (W 110) | 60 - 65 60 - 65 62 - 65 65 - 67 65 - 67 | | | 551016 | | | 554003 | |
| | | | | | | | | | |
| W Series (W113) | | | | | | | | | |
| 230 SL, 250 SL 280 SL 250 S, 250 SE Coupé & Cabrio | (W 113) | 63 - 72 68 - 72 65 - 68 | | | 551016 | | | 554003 | |
| | | | | | | | | | |
| W Series (W114, W115) | | | | | | | | | |
| 200, 200 D, 220, 220 D, 230 250, 250 C, 250 CE 280, 280 C, 280 CE, 280 E 230/4, 240 D, 240 D/3.0 | (W 115) (W 114) | 68 - 76 71 - 76 73 - 76 | | 341002 | 551017 | | | 344002 | 554004 |
| | | | | | | | | | |
| W Series (W123, C123, S123) | | | | | | | | | |
| 200, 200 D, 220 D, 230, 230 C, 240 D 250, 280, 280 C, 280 CE, 280 E 300 D, 300 T | (123) | 76 - 12.84 | | | 551018 | | | 554004 | |
| | | | | | | | | | |
| 200 T, 230 T, 250 T, 280 TE, 240 TD, 300 TD | (123) | 10.77 - 85 | | | 551018 | | | | |
| | | | | | | | | | |
| Mercedes Benz Commercial (D) | | | | | | | | | |
| 200, 300, 400 Series | | | | | | | | | |
| L208, L210 L207 D, L208 D, L209 D, L210 D L308, L310 L307 D, L308 D, L309 D, L310 D | (601) (601) (602) (602) | | 443170 | | | | 441081 | | |
| | | | | | | | | | |
| L406 D | (310) | | 444154 | | | | 444154 | | |
| | | | | | | | | | |



| MODEL FAHRZEUG MODELE | YEAR JAHR ANNEE | FRONT/VORNE/AVANT | | | | REAR/HINTEN/ARRIERE | | | |
|-----------------------------|-----------------------|-----------------------------|-----------------------------|--------------------------------|--|-----------------------------|-----------------------------|--------------------------------|--|
| | | PREMIUM Twin-tube Oil | EXCEL-G Twin-tube Gas | GAS-A-JUST Mono-tube Gas | | PREMIUM Twin-tube Oil | EXCEL-G Twin-tube Gas | GAS-A-JUST Mono-tube Gas | |

Mercedes Benz Commercial (D)

200, 300, 400 Series

| | | | | | | | | | |
|--|--|---------|--|--|--|---------|--|--|--|
| L408 (611) | | 444154 | | | | 444154 | | | |
| L406 DG (309.100-103/111-116/124-126) L407 D (309.100-103/111-116/124-126) LK406 DG, LK407 D (309.140/141/144) | | 444147▼ | | | | 444147▼ | | | |
| L408 G, L409, L410 (309.000-026) L408 DG (309.000-303/311-316/324-326) LF408 G (309.054/055) LK408 G, LK409, LK410 (309.040/041/044) LKO406 DG, LKO407 D (309.130-135) LKO408 G, LKO409 (309.030-035) | | 444146 | | | | 444146 | | | |
| LF408 G, LF409, LF410 (309.050) 005094 → 148036 | | 444146 | | | | 444146 | | | |
| LF408 G, LF409, LF410 (309.050) 148037 → 526086 | | 444146 | | | | 444147▼ | | | |
| LF408 G, LF409, LF410 (309.050) 526087 → | | 444146 | | | | 444146 | | | |
| LF408 G, LF409, LF410 (309.056/059) 148037 → 185439 | | 444146 | | | | 444147▼ | | | |
| LF408 G, LF409, LF410 (309.056/059) 185440 → 275292 | | 444146 | | | | 444146 | | | |
| LF408 G, LF409, LF410 (309.056/059) 275293 → 526086 | | 444147▼ | | | | 444147▼ | | | |

500, 600, 700, 800 Series

| | | | | | | | | | |
|--|--|----------------------|--|--|--|--------|--|--|--|
| L508 D, L508 DG (310) L613 | | 444154 | | | | 444154 | | | |
| LT608 D (310,100) | | 444146 | | | | | | | |
| L508 D (309.400-405/411-416/424-427/429) L508 DG (309.400-405/411-416/424-427/429) LF508 D (310.350) LK508 D (309.440-442/444/445) LKO508 DG (309.430-433/435) L608 D (310.000-305/311-316/324-327/329) L608 D (310.400-405/424-327/429) LF608 D (310.350) LK608 D (310.340-345/440-445) L613 D (313) | | 444146 | | | | 444146 | | | |
| 507 D (667.301/302/341/342/361/362) 508 D (667.301/302) 510 (667.001/002/061/062) | | 444145 ¹⁾ | | | | | | | |

1)





| MODEL FAHRZEUG MODELE | YEAR JAHR ANNEE | FRONT/VORNE/AVANT | | | | REAR/HINTEN/ARRIERE | | | |
|---|-----------------------|-----------------------------|-----------------------------|--------------------------------|--|-----------------------------|-----------------------------|--------------------------------|--|
| | | PREMIUM Twin-tube Oil | EXCEL-G Twin-tube Gas | GAS-A-JUST Mono-tube Gas | | PREMIUM Twin-tube Oil | EXCEL-G Twin-tube Gas | GAS-A-JUST Mono-tube Gas | |
| Mercedes Benz Commercial (D) | | | | | | | | | |
| 500, 600, 700, 800 Series | | | | | | | | | |
| 512 D (667.321-323/351-353) 609 D (668.001-003/041/042/061-063) 709 D (669.001-003/041/042/061-063) 711 D (669.302/303/362/363) 809 D (670.001-003/041/042/061-063) 811 D (670.302/303/362/363) 814 D (670.312/313/364-366) | | 444145 ¹⁾ | | | | | | | |
| 614 D | | 444145 ¹⁾ | | | | | | | |
| LP608, LP709 (314.051-053/055-060) LPS608, LPS709 (314.063) LPK608, LPK709 (314.072) LPKF608, LPKF709 (314.081-083) LPKO608, LPKO709 (314.077) LPO608, LPO709 (314.085-087) | | | | | | 444154 | | | |
| 808 L, LPK, LPKF, LPO (316) 809 LP, LPK, LPKF, LPO | | | | | | 444154 | | | |
| 1) Lmax = 633 mm | | | | | | | | | |
| Citan | | | | | | | | | |
| (415.603, 415.703) Exc. , H/D, | 11.12- | | 339766 | | | | 344709 ¹⁾ | | |
| (415) Exc. | 11.12- | | 3338011 | | | | 344709 ¹⁾ | | |
| 1) Incl. Models 415.601, 415.605, 415.705 Incl. , H/D | | | | | | | | | |
| MB Series | | | | | | | | | |
| MB100 D (631) | 84 - | 443272 | | | | 444126 | | | |
| MB140, MB160, MB180 (631) | 84 - | 443273 | | | | 444127▼ | | | |
| O309, O310 | | | | | | | | | |
| O309 B (309) O309 D | | 444146 ¹⁾ | | | | 444146 ¹⁾ | | | |
| O309 D (310, 313, 323) | | 444154 | | | | 444154 | | | |
| O309 D (602) O310 D | | 443170 | | | | 441081 | | | |
| 1) Lmax = 625 mm | | | | | | | | | |



| MODEL FAHRZEUG MODELE | YEAR JAHR ANNEE | FRONT/VORNE/AVANT | | | | REAR/HINTEN/ARRIERE | | | |
|-----------------------------|-----------------------|-----------------------------|-----------------------------|--------------------------------|--|-----------------------------|-----------------------------|--------------------------------|--|
| | | PREMIUM Twin-tube Oil | EXCEL-G Twin-tube Gas | GAS-A-JUST Mono-tube Gas | | PREMIUM Twin-tube Oil | EXCEL-G Twin-tube Gas | GAS-A-JUST Mono-tube Gas | |

Mercedes Benz Commercial (D)

O609, O611, O614

| | | | | | | | | | |
|------------------------|-------|--|--------|--|--|--|--|--|--|
| O609 D, O611 D, O614 D | (672) | | 444145 | | | | | | |
|------------------------|-------|--|--------|--|--|--|--|--|--|

Sprinter (901, 902, 903, 904)

| | | | | | | | | | |
|--|-------------|--|--------|--|--|--------|--------|--|--|
| 208 D (901.311/312/361/362/371/372) 208 D (902.311/312/322/361/362/371/372) 212 D (901.461/462/471/472) 212 D (902.411/412/422/461/462/471/472) 214 (901.011/012/061/062/071/072) 214 (902.011/012/022/061/062/071/072) 308 D (903.311-313/322/323/361-363/371-373) 312 D (903.411-413/422/423/461-463/471-473) 314 (903.011-013/022/023/061-063/071-073) 208 CDI, 211 CDI, 213 CDT, 308 CDI 311 CDI, 313 CDI, 316 CDI | 2.95 - 5.06 | | 335810 | | | 441081 | 341339 | | |
| 408 D, 408 CDI 410, 410 D 411 D, 411 CDI 412 D (904.412/413/422/423/462/463) 413 CDI 414 (904.012/013/022/023/062/063) 416 CDI | 2.96 - 5.06 | | 335809 | | | 444262 | 344409 | | |

Sprinter (905)

| | | | | | | | | | |
|---------|-------|-------------|--|--|--|--|--|--|--|
| 616 CDI | (905) | 4.01 - 5.06 | | | | | | | |
|---------|-------|-------------|--|--|--|--|--|--|--|

Sprinter II

| | | | | | | | | | |
|---------------------------------|-------|--------|--|--------|--|--|--------|--|--|
| 200 Series Exc. H/D | (906) | 6.06 - | | 331701 | | | 343484 | | |
| 200 Series ⊕ H/D | (906) | 6.06 - | | 331702 | | | 349045 | | |
| 300 Series Exc. H/D, | (906) | 6.06 - | | 331701 | | | 343484 | | |
| 300 Series ⊕ H/D Exc. | (906) | 6.06 - | | 331701 | | | 349045 | | |
| 300 Series ⊕ | (906) | 6.06 - | | 331701 | | | 349050 | | |
| 400 Series Incl. H/D Exc. | (906) | 6.06 - | | 331702 | | | 349044 | | |
| 400 Series ⊕ | (906) | 6.06 - | | 331702 | | | 349051 | | |



| MODEL FAHRZEUG MODELE | YEAR JAHR ANNEE | FRONT/VORNE/AVANT | | | | REAR/HINTEN/ARRIERE | | | |
|-----------------------------|-----------------------|-----------------------------|-----------------------------|--------------------------------|--|-----------------------------|-----------------------------|--------------------------------|--|
| | | PREMIUM Twin-tube Oil | EXCEL-G Twin-tube Gas | GAS-A-JUST Mono-tube Gas | | PREMIUM Twin-tube Oil | EXCEL-G Twin-tube Gas | GAS-A-JUST Mono-tube Gas | |

Mercedes Benz Commercial (D)

Sprinter II

| | | | | | | | | | | |
|-----------------------------|-------|--------|--------|--------|--|--|--|----------------------|--|--|
| 500 Series 5-t Incl. | (906) | 6.06 - | | 331702 | | | | 349044 | | |
| | | | 940003 | SM1547 | | | | | | |
| 500 Series 5-t | (906) | 6.06 - | | 331700 | | | | 349051 ¹⁾ | | |
| | | | 940003 | SM1547 | | | | | | |
| 3.5 t | (906) | 2.06 - | | 331700 | | | | | | |
| | | | 940003 | SM1547 | | | | | | |

1) → 9.12; Incl.

Sprinter III

| | | | | | | | | | | |
|---|--------------|--------|--|--|--|--|--|--|--|--|
| 3-t 211 CDI, 214 CDI, 215 CDI 216 CDI, 217 CDI | (B907, B910) | 2.18 - | | 331701 ¹⁾²⁾ 331702 ¹⁾²⁾ | | | | | | |
| 3,5-t 311 CDI (11 = OM 651.958) 314 CDI, 316 CDI, 319 CDI | (B907, B910) | 2.18 - | | 331701 ¹⁾²⁾ 331702 ¹⁾²⁾ | | | | | | |
| 4-t 411 CDI, 414 CDI, 416 CDI, 419 CDI | (B907, B910) | 2.18 - | | 331701 ¹⁾ 331702 ¹⁾ | | | | | | |
| 5-t | (B907, B910) | 2.18 - | | 331702 | | | | | | |

1)

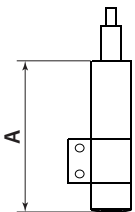

| PN | A |
|--------|--------|
| 331701 | 365 mm |
| 331702 | 390 mm |

2) Exc. OE 9073205801

Vito

| | | | | | | | | | | |
|--|--------|---|--------|--------|--|--|--|--------|--------|--|
| Exc. | (638) | 96 - 03 | | 334620 | | | | 343305 | | |
| | | | 913112 | SM5499 | | | | | | |
| 119, 122, 123 126 109 CDI (65 kW), 111 CDI (80 kW) 109 CDI (70 kW), 111 CDI (85 kW) 115 CDI, 120 CDI Exc. | (W639) | 9.03 - 9.07 - 8.10 9.03 - 9.06 - 8.10 9.03 - 8.10 | | 335931 | | | | | 553337 | |
| | | | 910113 | SM1007 | | | | | | |
| 119, 122, 123 126 109 CDI (65 kW), 111 CDI (80 kW) 109 CDI (70 kW), 111 CDI (85 kW) 115 CDI, 120 CDI Exc. | (W639) | 9.03 - 9.07 - 8.10 9.03 - 9.06 - 8.10 9.03 - 8.10 | | 335931 | | | | | 553338 | |
| | | | 910113 | SM1007 | | | | | | |

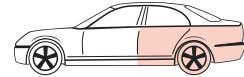
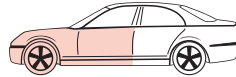

Mini

| MODEL FAHRZEUG MODELE | YEAR JAHR ANNEE | FRONT/VORNE/AVANT | | | | REAR/HINTEN/ARRIERE | | | |
|-----------------------------|-----------------------|-----------------------------|-----------------------------|--------------------------------|--|-----------------------------|-----------------------------|--------------------------------|--|
| | | PREMIUM Twin-tube Oil | EXCEL-G Twin-tube Gas | GAS-A-JUST Mono-tube Gas | | PREMIUM Twin-tube Oil | EXCEL-G Twin-tube Gas | GAS-A-JUST Mono-tube Gas | |

Mercedes Benz Commercial (D)

Vito

| | | | | | | |
|---|---|---------|--|--|--------|--|
| (W639) 119, 122, 123 126 109 CDI (65 kW), 111 CDI (80 kW) 109 CDI (70 kW), 111 CDI (85 kW) 115 CDI, 120 CDI | 9.03 - 9.07 - 8.10 9.03 - 9.06 - 8.10 9.03 - 8.10 | 335931 | | | 553337 | |
| (W639) 119, 122, 123 126 109 CDI (65 kW), 111 CDI (80 kW) 109 CDI (70 kW), 111 CDI (85 kW) 115 CDI, 120 CDI Incl. | 9.03 - 9.07 - 8.10 9.03 - 9.07 - 8.10 9.03 - 8.10 | 335931 | | | 553337 | |
| (W639) 126 109 CDI (70 kW), 110 CDI 111 CDI (85 kW), 113 CDI, 115 CDI 116 CDI, 120 CDI, 122 CDI E-CELL Incl. Sport sus., Comfort sus. | 9.10 - | 3358026 | | | | |
| (W639) 109 CDI, 111 CDI, 115 CDI | 7.06 - 8.10 | | | | 553337 | |

Mercury (US) → Ford (US)

Mini (D)

Mini

| | | | | | | |
|--|--|----------------------|--|--|--------------------------------|--|
| One, One D (R50, R52, R53) Cooper, Cooper S | 9.01 - 3.02 9.01 - 9.02 | | | | 341924 SM5444 | |
| One, Cooper (R50, R52, R53) One D Cooper S Cabriolet | 3.02 - 10.06 5.03 - 10.06 4.02 - 10.06 7.04 - 10.06 | 334622 L 334621 R | | | 341924 SM5444 ¹⁾ | |
| One, One D (R56, R57) Cooper, Cooper D Cooper S, Cooper SD Incl. Exc. Sport sus. | 10.06 - | 334699 L 334698 R | | | 341683 SM5444 ²⁾ | |
| Cooper S John Cooper Works (R56) John Cooper Works John Cooper Works GP | 11.06 - 11.13 | | | | SM5444 | |
| (F55, F56) Incl. Sport sus. Exc. | 4.13 - | | | | SM9926 | |

1) 3.02- 1.07 2) Exc. 3) Only (R52)



| MODEL FAHRZEUG MODELE | YEAR JAHR ANNEE | FRONT/VORNE/AVANT | | | | REAR/HINTEN/ARRIERE | | | |
|--|-----------------------|-----------------------------|-----------------------------|--------------------------------|--|-----------------------------|-----------------------------|--------------------------------|--|
| | | PREMIUM Twin-tube Oil | EXCEL-G Twin-tube Gas | GAS-A-JUST Mono-tube Gas | | PREMIUM Twin-tube Oil | EXCEL-G Twin-tube Gas | GAS-A-JUST Mono-tube Gas | |
| Mini (D) | | | | | | | | | |
| Mini Clubman | | | | | | | | | |
| (R55) | 10.07 - | | | | | | | | |
| One, Cooper S (120 kW) Cooper S ALL 4 (120 kW) Cooper S JCW, Cooper S JCW ALL 4 Cooper D (100 kW), Cooper SD (120 kW) Cooper SD ALL 4 (120 kW) | (F54) 11.14 - | | | | | | | | |
| Cooper, Cooper S (141 kW) Cooper S ALL 4 (141 kW) John Cooper Works, One D Cooper D (110 kW), Cooper SD (140 kW) Cooper SD ALL 4 (140 kW) | (F54) 11.14 - | | | | | | | | |
| 1) Exc. | | | | | | | | | |
| Mini Convertible | | | | | | | | | |
| (F57) Exc. | 11.14 - | | | | | | | | |
| Mini Coupé | | | | | | | | | |
| (R58) | 9.11 - | | | | | | | | |
| Mini Roadster | | | | | | | | | |
| (R59) | 1.11 - | | | | | | | | |
| Mini Countryman | | | | | | | | | |
| (R60) Incl. Sport sus. | 1.10 - 10.16 | | | | | | | | |
| (F60) Incl. Sport sus. Exc. Cooper SE ALL4, John Cooper Works, | 10.16 - | | | | | | | | |
| Cooper SE ALL4 (F60) | 1.17 - | | | | | | | | |
| 1) Incl. John Cooper Works | | | | | | | | | |
| Mini Paceman | | | | | | | | | |
| (R61) Incl. Sport sus. | 3.12 - 9.16 | | | | | | | | |



Mitsubishi

| MODEL FAHRZEUG MODELE | YEAR JAHR ANNEE | FRONT/VORNE/AVANT | | | | REAR/HINTEN/ARRIERE | | | |
|--|---|--|-----------------------------|--------------------------------|--|-----------------------------|-----------------------------|--------------------------------|--|
| | | PREMIUM Twin-tube Oil | EXCEL-G Twin-tube Gas | GAS-A-JUST Mono-tube Gas | | PREMIUM Twin-tube Oil | EXCEL-G Twin-tube Gas | GAS-A-JUST Mono-tube Gas | |
| Mitsubishi (J) | | | | | | | | | |
| 3000 GT, GTO | | | | | | | | | |
| 3.0 (4WD) Exc. | (ZI) 6.92 - | | 335013 | | | | 341183 | | |
| ASX | | | | | | | | | |
| | (GA_W_) 2.10 - | | 339254 L 339253 R | | | | 340060 | | |
| | | 935304 ▼ SM5657 | | | | 910349 SM5091 | | | |
| | | 912053 | | | | | | | |
| Carisma | | | | | | | | | |
| 1.6, 1.9 TD Incl. ABS Exc. 6B Model | (DA) 5.95 - 2.99 | | 333222 L 333221 R | | | | 341204 | | |
| | | | | | | 910331 | | | |
| 1.8 (85 kW, 103 kW) 1.8 GDI (92 kW) Incl. ABS Exc. 6B Model | (DA) 5.95 - 2.99 | | 334155 L 334154 R | | | | 341204 | | |
| | | 917300 | | | | 910331 | | | |
| 1.3, 1.6, 1.8 GDI, 1.9 TD, 1.9 DI-D Exc. High Ground Clearance sus. | (DA) 3.99 - 6.06 | | 334309 L 334308 R | | | | 341204 | | |
| | | 917300 | | | | 910331 | | | |
| Colt - Mirage | | | | | | | | | |
| 1400 Turbo | (A 152) 12.78 - 84 | | | | | | 343183 | | |
| Colt II | | | | | | | | | |
| 1200 1500 1600 Turbo 1800 Diesel | (C 15A) (C 12A) (C 13A) (C 14A) 1.84 - 11.85 | 633040 | | | | | | | |
| | | 913271 SM5316 ▼ | | | | OE = MB 242818 | | | |
| 1200 1500 1600 Turbo 1800 Diesel | (C 15A) (C 12A) (C 13A) (C 14A) 12.85 - 5.86 | 633040 | | | | 443250 | | | |
| | | 913271 SM5316 ▼ | | | | OE = MB 515097 | | | |
| 1200 1300 1800 Diesel | (C 15A) (C 11A) (C 14A) 6.86 - 6.88 | 633059 | | | | 443250 | | | |
| | | 913212 ▼ SM5317 ¹⁾ ▼ SM5318 ²⁾ ▼ | | | | OE = MB 515097 | | | |
| 1500 1600 Turbo / ECI Turbo Exc. (C 12A/13A ***PL 6) | (C 12A) (C 13A) 6.86 - 2.89 | 633059 | | | | 443250 | | | |
| | | 913212 ▼ SM5317 ¹⁾ ▼ SM5318 ²⁾ ▼ | | | | OE = MB 515097 | | | |
| 1500 | (C 12A ** JPL 6) 6.86 - 5.87 | 633040 | | | | 443250 | | | |
| | | 913271 | | | | OE = MB 515097 | | | |
| 1600 Turbo | (C 13 AMNJTPL 6) 6.86 - 5.87 | 633040 | | | | | | | |
| | | 913271 | | | | OE = MB 242818 | | | |

1) ⊕ ⊕

2) ⊖ ⊕



| MODEL FAHRZEUG MODELE | YEAR JAHR ANNEE | FRONT/VORNE/AVANT | | | | REAR/HINTEN/ARRIERE | | | |
|--|---|-----------------------------|-----------------------------|--------------------------------|--|-----------------------------|-----------------------------|--------------------------------|--|
| | | PREMIUM Twin-tube Oil | EXCEL-G Twin-tube Gas | GAS-A-JUST Mono-tube Gas | | PREMIUM Twin-tube Oil | EXCEL-G Twin-tube Gas | GAS-A-JUST Mono-tube Gas | |
| Mitsubishi (J) | | | | | | | | | |
| Colt III | | | | | | | | | |
| 1300 (C 51A/V) 1500 (C 52A) 1800 Diesel (C 54A) | 4.88 - 11.88 | | 334019 | | | 441079▼ | 341084 | | |
| | | 917302 | SM5063 | | | | SM5091 | | |
| 1300 (C 51A/V) 1500 (C 52A) 1600 GTi-16V (C 54A) 1800 GTi-16V (C 58A) | 12.88 - 92 12.88 - 92 4.88 - 5.90 11.89 - 92 | | 334019 | | | | 341084 | | |
| | | 917302 | SM5063 | | | | SM5091 | | |
| <u>2WD</u> 1800 Diesel (C54A) Exc. | 12.88 - 92 | | 334019 | | | | 341084 | | |
| | | 917302 | SM5063 | | | OE = MB631341, MB631342 | SM5091 | | |
| <u>2WD</u> 1800 Diesel (C54A) + | 12.88 - 92 | | 334019 | | | | | | |
| | | 917302 | SM5063 | | | | SM5091 | | |
| Colt IV | | | | | | | | | |
| <u>2WD</u> 1300, 1600 (CA 1A, CA 4A) Exc. | 12.91 - 96 | 633148 L 633147 R | 333125 L 333124 R | | | | 341140 | | |
| | | | SM5109▼ | | | OE = MB809270 | 910331 SM5091 | | |
| <u>2WD</u> 1300, 1600 (CA 1A, CA 4A) + | 12.91 - 96 | 633148 L 633147 R | 333125 L 333124 R | | | | 341145 | | |
| | | | SM5109▼ | | | OE = MB891463 | 910331 SM5091 | | |
| <u>2WD</u> 1800 GTi (CA 5A) | 12.91 - 96 | | 334073 L 334072 R | | | | 341140 | | |
| | | | SM5109▼ | | | 910331 SM5091 | | | |
| <u>4WD</u> 1600 (CC4A) | 12.91 - 96 | 633148 L 633147 R | 333125 L 333124 R | | | | 341140 | | |
| | | | SM5109▼ | | | 910331 SM5091 | | | |
| Colt V | | | | | | | | | |
| <u>2WD</u> 1300, 1500, 1600 (CJ1, CJ2, CJ4) Exc. | 96 - 3.97 | | 333225 L 333224 R | | | | 341140 | | |
| | | | SM5311 | | | 910331 | | | |
| 1300 (CJ1) Exc. | 4.97 - 6.03 | | 332113 L 332112 R | | | | 341140 | | |
| | | | SM5152 | | | 910331 ¹⁾ SM5091 | | | |
| 1600 (CJ4) Exc. | 4.97 - 6.03 | | 333319 L 333318 R | | | | 341140 | | |
| | | | SM5152 | | | 910331 ¹⁾ SM5091 | | | |
| <u>2WD</u> 1300, 1500, 1600 (CJ1, CJ2, CJ4) + | 96 - 3.97 | | | | | | 341145 | | |
| | | | SM5311 | | | 910331 | | | |
| 1300, 1600 (CJ1, CJ4) + | 4.97 - 6.03 | | | | | | | | |
| | | | SM5152 | | | 910331 ¹⁾ SM5091 | | | |
| 1) → 6.99 | | | | | | | | | |



Mitsubishi

| MODEL FAHRZEUG MODELE | YEAR JAHR ANNEE | FRONT/VORNE/AVANT | | | | REAR/HINTEN/ARRIERE | | | |
|---|--------------------------------------|-----------------------------|-----------------------------|--------------------------------|--|-----------------------------|-----------------------------|--------------------------------|--|
| | | PREMIUM Twin-tube Oil | EXCEL-G Twin-tube Gas | GAS-A-JUST Mono-tube Gas | | PREMIUM Twin-tube Oil | EXCEL-G Twin-tube Gas | GAS-A-JUST Mono-tube Gas | |
| Mitsubishi (J) | | | | | | | | | |
| Colt VI | | | | | | | | | |
| 1.1, 1.1 Bifuel, 1.3, 1.3 Bifuel 1.3 Flex, 1.5, 1.5 DI-D Exc. | (Z30) 6.04 - 6.12 | | 3338017 L 3338016 R | | | 343411 | | | |
| | | 912051 ¹⁾ | SM1032 ²⁾ | | | 910167 ²⁾ | SM9923 ²⁾ | | |
| 1.1, 1.3 1.1 Bifuel, 1.3 Bifuel, 1.3 Flex, 1.5, 1.5 DI-D ⊕ | (Z30) 12.04 - 6.12 6.04 - 6.12 | | 3338021 L 3338020 R | | | | | | |
| | | 912051 ¹⁾ | SM1032 ²⁾ | | | 910167 ²⁾ | SM9923 ²⁾ | | |
| 1.5 CZT ⊕ | (Z30) 3.05 - 6.12 | | 3338019 L 3338018 R | | | | | | |
| | | | | | | 910167 ²⁾ | SM9923 ²⁾ | | |
| 1) Exc. → 12.04 2) Incl. | | | | | | | | | |
| Exc. 1.5 CZT 10.08- | | | | | | | | | |
| Cordia & Tredia | | | | | | | | | |
| (A210 series) 1400, 1500, 1600, 1800 Exc. Turbo | 2.82 - 87 | 634001 | | | | | | | |
| | | 913271 | SM5095▼ | | | | | | |
| 1600 Turbo 1800 Turbo | (A 212) (A 213) 2.82 - 87 | 634001 | | | | 343183 | | | |
| | | 913271 | SM5095▼ | | | | | | |
| Tredia 1800 (A 215 G), 2000 (A 217 G) | 85 - 87 | | 334033▼ | | | 343183 | | | |
| | | | SM5095▼ | | | | | | |
| Eclipse | | | | | | | | | |
| (D 21A, D 22A) 1800, 2000, 2000 Turbo Incl. ABS | 1.90 - 3.94 | | 334030 | | | 341114 | | | |
| | | 917300 | SM5072 | | | SM5091 | | | |
| 2000 Incl. ABS | (D 27A) 4.91 - 3.94 | | 334030 | | | | | | |
| | | 917300 | SM5072 | | | SM5091 | | | |
| 2000 Incl. ABS | (D 32A) 8.95 - 99 | | 341163 | | | 341165 | | | |
| | | | SM5091 | | | SM5091 | | | |
| Eclipse Cross | | | | | | | | | |
| Exc. Hybrid | (GK_) 10.17 - | | 3350037 L 3350036 R | | | 3410059 | | | |
| FTO | | | | | | | | | |
| | (DE 2A, DE 3A) 94 - 97 | | 334391 L 334390 R | | | 341140 | | | |
| Galant, Sapporo (Lambda), Sigma | | | | | | | | | |
| 1600 Exc. | (E11A) 8.83 - 87 | | | | | 441053 | 341054 | | |
| | | 917300 | | | | SM5091 | | | |



| MODEL FAHRZEUG MODELE | YEAR JAHR ANNEE | FRONT/VORNE/AVANT | | | | REAR/HINTEN/ARRIERE | | | |
|--|-----------------------|-----------------------------|-----------------------------|--------------------------------|---------|-----------------------------|-----------------------------|--------------------------------|--|
| | | PREMIUM Twin-tube Oil | EXCEL-G Twin-tube Gas | GAS-A-JUST Mono-tube Gas | | PREMIUM Twin-tube Oil | EXCEL-G Twin-tube Gas | GAS-A-JUST Mono-tube Gas | |
| Mitsubishi (J) | | | | | | | | | |
| Galant, Sapporo (Lambda), Sigma | | | | | | | | | |
| 1800 Turbo Diesel (E14A) 2000, 2000 Turbo (E15A) 2400 (E16A) Exc. ABS, | 8.83 - 87 | | | | | 441053 | 341054 | | |
| | | 917300 | | | | SM5091 | | | |
| Incl. ABS 1600 (E 31A) 1800 (E 32A) 2000, 2000 GTi-16V (E 33A) 1800 Diesel Turbo (E 34A) Exc. | 12.87 - 92 | 634023▼ | 334030 | | | 441053 | 341054 | | |
| | | 917300 | | | | SM5091 | | | |
| ⊖ ABS 2000, 2000 GTi-16V (E 38A, E 39A) Incl. | 6.88 - 92 | 634034▼ | | | | 441078▼ | | | |
| | | 917300 | | | | SM5091 | | | |
| ⊕ ABS 2000, 2000 GTi-16V (E 38A, E 39A) Incl. | 6.88 - 5.90 | 634034▼ | | | | 441078▼ | | | |
| | | 917300 | | | | SM5091 | | | |
| ⊕ ABS 2000, 2000 GTi-16V (E 38A, E 39A) Incl. | 6.90 - 92 | | 334044▼ | | | 441078▼ | | | |
| | | 917300 | | | | SM5091 | | | |
| 1800 (E52A) 2000 (E55A, E 75A) 2000 24V (E54A, E 64A) 2000 Diesel Turbo (E57A) 2500 24V (E88A) Incl. H/D, , , Exc. | 11.92 - 96 | | 341141 | | | 441087 | 341142 | | |
| | | SM5091 | | | | SM5091 | | | |
| (EA2A, EA5A, EA6A) 2000, 2500, 2000 Turbo Diesel, 2.4 GD Incl. H/D, | 10.96 - 10.04 | | 341141 351029 | | | | 341213 351030 | | |
| | | SM5091 | | | | SM5091 | | | |
| Galant, Sapporo (Lambda), Sigma | | | | | | | | | |
| 1300, 1500 (A 51 V, 52 V, 53 V) | 12.69 - 3.73 | | | | | 443066 | 343121 | 553083 | |
| (EA2W, EA5W, EA6W) 2000, 2500, 2000 Turbo Diesel, 2.4 GD Exc. , , | 10.96 - 10.03 | | 341141 351029 | | | | 341213 351030 | | |
| | | SM5091 | | | | SM5091 | | | |
| (EA2W, EA5W, EA6W) 2000, 2500, 2000 Turbo Diesel, 2.4 GD ⊕ , Exc. | 10.96 - 10.03 | | 341141 | | | | 341241 | | |
| | | SM5091 | | | | SM5091 | | | |
| Galloper | | | | | | | | | |
| | (JK01) | 2.99 - 12.06 | | 344119 | 554061▼ | | 344116 | 554068▼ | |
| | | | | | | | | | |



Mitsubishi

| MODEL FAHRZEUG MODELE | YEAR JAHR ANNEE | FRONT/VORNE/AVANT | | | | REAR/HINTEN/ARRIERE | | | |
|---|--|---|--|--------------------------------|--|-----------------------------|--------------------------------------|--------------------------------|--|
| | | PREMIUM Twin-tube Oil | EXCEL-G Twin-tube Gas | GAS-A-JUST Mono-tube Gas | | PREMIUM Twin-tube Oil | EXCEL-G Twin-tube Gas | GAS-A-JUST Mono-tube Gas | |
| Mitsubishi (J) | | | | | | | | | |
| Grandis | | | | | | | | | |
| 2.4 i 2.0 DiD Exc. | (NA 4W) (NA 8W) | 4.04 - 9.05 - | | 334457 L 334456 R | | | 343436 | | |
| | | | 935304 ▼ 912053 | | | | | | |
| 2.4 i 2.0 DiD | (NA 4W) (NA 8W) | 4.04 - 9.05 - | | 334459 L 334458 R | | | 343437 | | |
| | | | 935304 ▼ 912053 | | | | | | |
| Lancer | | | | | | | | | |
| 1200, 1400 | (A 75, 72) | 1.73 - 8.76 | | | | 443194 | 343153 | | |
| 1600 | (A 73) | 1.73 - 8.76 | | | | 443194 | 343153 | | |
| 1400, 1600, 1800 Exc. Turbo | (A 172, 174, 175) | 1.81 - 9.83 | | 363007 ¹⁾ ▼ | | | | | |
| 1200 1500 1600 Turbo 1800 Diesel | (C 15A) (C 12A) (C 13A) (C 14A) | 1.84 - 11.85 | 633040 | | | | | | |
| | | | 913271 SM5316 ▼ | | | | OE = MB 242818 | | |
| 1200 1500 1600 Turbo 1800 Diesel | (C 15A) (C 12A) (C 13A) (C 14A) | 12.85 - 5.86 | 633040 | | | 443250 | | | |
| | | | 913271 SM5316 ▼ | | | | OE = MB 515097 | | |
| 1200 1300 1800 Diesel | (C 15A) (C 11A) (C 14A) | 6.86 - 6.88 | 633059 | | | 443250 | | | |
| | | | 913212 ▼ SM5317 ²⁾ ▼ SM5318 ³⁾ ▼ | | | | OE = MB 515097 | | |
| 1500 1600 Turbo/ECl Turbo Exc. | (C 12A) (C 13A) (C 12A/133*** PL6) | 6.86 - 2.89 | 633059 | | | 443250 | | | |
| | | | 913212 ▼ SM5317 ²⁾ ▼ SM5318 ³⁾ ▼ | | | | OE = MB 515097 | | |
| 1500 | (C 12A **JPL 6) | 6.86 - 5.87 | 633040 | | | 443250 | | | |
| | | | 913271 | | | | OE = MB 515097 | | |
| 1600 Turbo | (C 13AMNJTPL 6) | 6.86 - 5.87 | 633040 | | | | 341084 | | |
| | | | 913271 | | | | OE = MB 242818 | | |
| 1200 (C65A), 1300 (C61A) 1500 (C62A), A 1800 Diesel (C64A) | | 4.88 - 11.88 | | 334019 | | 441079 ▼ | 341084 | | |
| | | | 917302 SM5063 | | | | | | |
| 1200 (C65A), 1800 Diesel (C64A) 1600 GTi 16V (C63A) 1800 GTi 16V (C68A) | | 12.88 - 92 4.88 - 5.90 11.89 - 92 | | 334019 | | | 341084 | | |
| | | | 917302 SM5063 | | | | | | |
| 1300 (C61A), 1500 (C62A) Exc. | | 12.88 - 95 | | 334019 | | | 341084 | | |
| | | | 917302 SM5063 | | | | OE = MB 631340, MB 631341, MB 631342 | | |

1) OE = MB 002190

2)

3)



| MODEL FAHRZEUG MODELE | YEAR JAHR ANNEE | FRONT/VORNE/AVANT | | | | REAR/HINTEN/ARRIERE | | | |
|---|-----------------------|-----------------------------|-----------------------------|--------------------------------|--|-----------------------------------|-----------------------------|--------------------------------|--|
| | | PREMIUM Twin-tube Oil | EXCEL-G Twin-tube Gas | GAS-A-JUST Mono-tube Gas | | PREMIUM Twin-tube Oil | EXCEL-G Twin-tube Gas | GAS-A-JUST Mono-tube Gas | |
| Mitsubishi (J) | | | | | | | | | |
| Lancer | | | | | | | | | |
| (2WD) 1300 (C61A), 1500 (C62A) ⊕ | 12.88 - 95 | | 334019 | | | | | | |
| | | | 917302 | | | OE = MB584403, MB911458 | | | |
| (2WD) 1600 (C66A), 1800 GTi (C69A) 2000 Diesel (C67A) | 6.92 - 95 | | 334019 | | | | 341084 | | |
| | | | 917302 | | | | | | |
| (4WD) 1800 (C77A) | 5.89 - 92 | | 334049▼ | | | | 341114 | | |
| | | | | | | | | | |
| (4WD) 1600 (C76A) | 6.92 - 95 | | 334049▼ | | | | 341114 | | |
| | | | | | | | | | |
| (2WD) 1300, 2000 Diesel (CB1A, CB8A) 1500, 1600 (CB2A, CB4A) Exc. | 5.92 - 96 5.92 - | 633148 L 633147 R | 333125 L 333124 R | | | | 341140 | | |
| | | | | | | OE = MB809271, MB809272, MB914897 | | | |
| | | | | | | | 910331 | | |
| (2WD) 1300, 2000 Diesel (CB1A, CB8A) 1500, 1600 (CB2A, CB4A) ⊕ | 5.92 - 96 5.92 - | 633148 L 633147 R | 333125 L 333124 R | | | | 341145 | | |
| | | | | | | OE = MB891463 | | | |
| | | | | | | | 910331 | | |
| (4WD) 1600 (CD 4A) | 5.92 - 93 | | 333125 L 333124 R | | | | 341140 | | |
| | | | | | | | | | |
| | | | | | | | 910331 | | |
| (2WD) 1800 GTi (CB 5A) | 5.92 - 96 | | 334073 L 334072 R | | | | 341140 | | |
| | | | | | | | | | |
| | | | | | | | 910331 | | |
| (2WD) 1300, 1500, 1600 (CK 1, CK 2, CK 4) Exc. | 96 - 6.03 | | 333225 L 333224 R | | | | 341140 | | |
| | | | | | | | | | |
| | | | | | | | 910331 ¹⁾ | | |
| (2WD) 1300, 1500, 1600 (CK 1, CK 2, CK 4) ⊕ | 96 - 6.03 | | | | | | 341145 | | |
| | | | | | | | | | |
| | | | | | | | 910331 ¹⁾ | | |
| (4WD) 2000 Lancer Evolution (CT9A) | 00 - 2.03 | | | | | | | | |
| | | | | | | | 910331 | | |
| 1.3 i (CS1A) 1.6 i (CS3A) | 6.03 - | | 334420 | | | | 341368 | | |
| | | | 930003▼ | | | | 910349 | | |
| | | | 910164 | | | | | | |
| 2.0 i Sport (CS9A) | 1.04 - | | 334369 | | | | 341368 | | |
| | | | 910164 | | | | 910349 | | |

1) → 6.99



Mitsubishi

| MODEL FAHRZEUG MODELE | YEAR JAHR ANNEE | FRONT/VORNE/AVANT | | | REAR/HINTEN/ARRIERE | | |
|-----------------------------|-----------------------|-----------------------------|-----------------------------|--------------------------------|-----------------------------|-----------------------------|--------------------------------|
| | | PREMIUM Twin-tube Oil | EXCEL-G Twin-tube Gas | GAS-A-JUST Mono-tube Gas | PREMIUM Twin-tube Oil | EXCEL-G Twin-tube Gas | GAS-A-JUST Mono-tube Gas |

Mitsubishi (J)

Lancer (CY_A) , Lancer Sportback (CX_A)

| | | | | | | | |
|--|--|--|----------------------|--|--------|--|--|
| 1.5 (CY2A) 1.8 (CY3A) 2.0 (CY4A) Incl. Invite series Exc. | 3.07 - 4.10 11.07 - 6.10 3.07 - 6.10 | | 339118 L 339117 R | | 341455 | | |
| (CX, CY) 1.5, 1.8, 1.8 LPG, 1.8 DI-D, 1.8 Flex 2.0, 2.0 DI-D Exc. | 3.07 - | | 339105 L 339104 R | | 341444 | | |
| (CX, CY) 1.5, 1.8, 1.8 LPG, 1.8 DI-D, 2.0, 2.0 DI-D | 3.07 - | | 339083 L 339082 R | | 341425 | | |

1) 2)

Lancer Estate

| | | | | | | | |
|--|----------------------------------|----------------------|--------------------------|--|----------|----------|--|
| 1200, 1400 (A72V, 75V, 141V, 142V, 148V, 149V) | 11.76 - 79 | | | | 443066 | 343121 | |
| 1500, 1800 Diesel (C12V, C14V) | 6.85 - 5.86 | 633040 | | | 443222 | 343203 ▼ | |
| 1500 (C12V), 1800 Diesel (C14V) (C12VLNJPL 6) Exc. | 6.86 - 6.87 | 633059 | | | 443222 | 343203 ▼ | |
| 1500 (C12VLNJPL 6) | 6.86 - 6.87 | 633040 | | | 443222 | 343203 ▼ | |
| 1500 (C12V), 1800 Diesel (C14V) | 7.87 - 92 | 633059 | | | 443222 | 343203 ▼ | |
| 1800 (C37V) | 11.86 - 92 | | | | 443251 ▼ | | |
| 1600, 2000 Diesel (CB 4W, CB 8W) Incl. | 6.92 - 6.03 | 633148 L 633147 R | 333125 L 333124 R | | 443263 | 343261 | |
| 1600 (CD 4W) | 6.92 - 6.03 | 633136 L 633135 R | 333123 L ▼ 333122 R ▼ | | 443263 | 343261 | |
| 1.6 i 2.0 i Exc. Sport | (CS3W) (CS9W) 6.03 - 10.08 | | 334420 | | 341368 | | |
| 1.6 i Sport 2.0 i Sport | (CS3W) (CS9W) 6.03 - 10.08 | | 334369 | | 341368 | | |



| MODEL FAHRZEUG MODELE | YEAR JAHR ANNEE | FRONT/VORNE/AVANT | | | REAR/HINTEN/ARRIERE | |
|--|--|-----------------------------|-----------------------------|--------------------------------|---------------------|-----------------------------|
| | | PREMIUM Twin-tube Oil | EXCEL-G Twin-tube Gas | GAS-A-JUST Mono-tube Gas | | PREMIUM Twin-tube Oil |
| Mitsubishi (J) | | | | | | |
| Lancer F | | | | | | |
| 1400 Turbo (A 152) | 82 - 84 | | | | 343183 | |
| Mirage / Space Star VI | | | | | | |
| 1.0, 1.0 BiFuel, 1.2 (59 kW) (A0_A) | 5.12 - | | 3320014 | | 348083 | |
| Outlander I | | | | | | |
| (2WD) (4WD) 2.0 i, 2.0 Turbo 2.4 i (CU2W) (CU5W) | 5.03 - 5.04 | | 334398 | | 341361 | |
| | | | 930003 ▼ SM5461 910164 | | 910330 SM5091 | |
| (2WD) (4WD) 2.0 i, 2.0 Turbo 2.4 i (CU2W) (CU5W) | 6.04 - 10.06 | | 334398 | | 341348 | |
| | | | 930003 ▼ SM5461 910164 | | 910330 SM5091 | |
| Outlander II | | | | | | |
| 2.0 Di-D (4WD) 2.2 Di-D (2WD) (4WD) ⊕ 5 Seater (CW_W) | 9.09 - 6.10 11.06 - 12.12 | | 339081 L 339080 R | | 340103 | |
| | | | 935304 ▼ SM5657 912053 | | 910349 SM5091 | |
| 2.0 Di-D (4WD) 2.0 Di-D (4WD) (7 Seater) 2.2 Di-D (2WD) (4WD) (7 Seater) 3.0 Mivec (4WD) (CW_W) | 11.06 - 8.09 9.09 - 6.10 11.06 - 12.12 11.06 - 8.13 | | 339081 L 339080 R | | 349040 | |
| | | | 935304 ▼ SM5657 912053 | | 910349 SM5091 | |
| 2.0 Mivec (2WD) (4WD) ⊕ (CW_W) | 11.06 - 8.13 | | 339081 L 339080 R | | 340103 | |
| | | | 935304 ▼ SM5657 912053 | | 910349 SM5091 | |
| 2.0 Mivec (2WD) (4WD) ⊕ (CW_W) | 11.06 - 8.13 | | 339125 L 339124 R | | 341454 | |
| | | | 935304 ▼ SM5657 912053 | | 910349 SM5091 | |
| 2.0 Mivec (2WD) (4WD) ⊕ (CW_W) | 11.06 - 8.09 | | 339125 L 339124 R | | 341454 | |
| | | | 935304 ▼ SM5657 912053 | | 910349 SM5091 | |
| 2.0 Mivec (2WD) (4WD) ⊕ (CW_W) Exc. (RUS) | 9.09 - 3.11 | | 339081 L 339080 R | | 340103 | |
| | | | 935304 ▼ SM5657 912053 | | 910349 SM5091 | |
| 2.0 Mivec (2WD) (4WD) ⊕ (CW_W) | 9.09 - 3.11 | | 339125 L 339124 R | | 341454 | |
| | | | 935304 ▼ SM5657 912053 | | 910349 SM5091 | |



Mitsubishi

| MODEL FAHRZEUG MODELE | YEAR JAHR ANNEE | FRONT/VORNE/AVANT | | | REAR/HINTEN/ARRIERE | | |
|-----------------------------|-----------------------|-----------------------------|-----------------------------|--------------------------------|-----------------------------|-----------------------------|--------------------------------|
| | | PREMIUM Twin-tube Oil | EXCEL-G Twin-tube Gas | GAS-A-JUST Mono-tube Gas | PREMIUM Twin-tube Oil | EXCEL-G Twin-tube Gas | GAS-A-JUST Mono-tube Gas |

Mitsubishi (J)

Outlander II

| | | | | | | |
|--|--------|---------------|---|--|-------------------------|--|
| 2.0 Mivec (2WD) (4WD) ⊕ | (CW_W) | 4.11 - 8.13 | 339125 L 339124 R 935304 ▼ SM5657 912053 | | 341454 910349 SM5091 | |
| 2.4 Mivec (2WD) (4WD) ⊕ 5 Seater | (CW_W) | 11.06 - 8.09 | 339081 L 339080 R 935304 ▼ SM5657 912053 | | 349040 910349 SM5091 | |
| 2.4 Mivec (2WD) (4WD) ⊕ 5 Seater | (CW_W) | 9.09 - 12.13 | 339081 L 339080 R 935304 ▼ SM5657 912053 | | 340103 910349 SM5091 | |
| 2.4 Mivec (2WD) (4WD) ⊕ 5 Seater | (CW_W) | 11.06 - 12.13 | 339081 L 339080 R 935304 ▼ SM5657 912053 | | 349040 910349 SM5091 | |
| 2.4 Mivec (2WD) (4WD) ⊕ 7 Seater | (CW_W) | 11.06 - 12.13 | 339081 L 339080 R 935304 ▼ SM5657 912053 | | 349040 910349 SM5091 | |
| 2.4 Mivec (2WD) (4WD) ⊕ Exc. (RUS) | (CW_W) | 11.06 - 8.09 | 339081 L 339080 R 935304 ▼ SM5657 912053 | | 349040 910349 SM5091 | |
| 2.4 Mivec (2WD) (4WD) ⊕ Exc. (RUS) | (CW_W) | 9.09 - 3.11 | 339081 L 339080 R 935304 ▼ SM5657 912053 | | 340103 910349 SM5091 | |
| 2.4 Mivec (2WD) (4WD) ⊕ Exc. (RUS) | (CW_W) | 4.11 - 6.11 | 339125 L 339124 R 935304 ▼ SM5657 912053 | | 341454 910349 SM5091 | |
| 2.4 Mivec (2WD) (4WD) ⊕ Exc. (RUS) | (CW_W) | 7.11 - 12.13 | 339081 L 339080 R 935304 ▼ SM5657 912053 | | 349040 910349 SM5091 | |
| 2.4 Mivec (2WD) (4WD) ⊕ (RUS) | (CW_W) | 11.06 - 12.13 | 339081 L 339080 R 935304 ▼ SM5657 912053 | | 349040 910349 SM5091 | |
| 2.4 Flex (4WD) ⊕ 5 Seater | (CW_W) | 11.06 - 6.10 | 339081 L 339080 R 935304 ▼ SM5657 912053 | | 340103 910349 SM5091 | |



| MODEL FAHRZEUG MODELE | YEAR JAHR ANNEE | FRONT/VORNE/AVANT | | | | REAR/HINTEN/ARRIERE | | | |
|--|--|-----------------------------|-----------------------------|--------------------------------|--|-----------------------------|-----------------------------|--------------------------------|--|
| | | PREMIUM Twin-tube Oil | EXCEL-G Twin-tube Gas | GAS-A-JUST Mono-tube Gas | | PREMIUM Twin-tube Oil | EXCEL-G Twin-tube Gas | GAS-A-JUST Mono-tube Gas | |
| Mitsubishi (J) | | | | | | | | | |
| Outlander II | | | | | | | | | |
| 2.4 Flex (4WD) ⊕ , 5 Seater (CW_W) | 11.06- 6.10 | | 339081 L 339080 R | | | 349040 | | | |
| | | 935304 ▼ SM5657 912053 | | 910349 SM5091 | | | | | |
| 2.4 Flex (4WD) ⊕ (CW_W) | 11.06- 6.10 | | 339081 L 339080 R | | | 349040 | | | |
| | | 935304 ▼ SM5657 912053 | | 910349 SM5091 | | | | | |
| Outlander III | | | | | | | | | |
| (GF_W, GG_W) 2.0 (kW : 107, 110) (2WD) (4WD) 2.0 Bifuel (107 kW) (2WD) (4WD) 2.3 Di-D (4WD) 2.4 (123 kW) (4WD) 3.0 GT (167 kW) (4WD) 2.2 Di-D (110 kW) (2WD) (4WD) | 8.12 - 10.12- 11.13 4.13- 11.13 10.12- 8.12- 11.13 8.12 - | | 3340046 L 3340045 R | | | 341454 | | | |
| | | 910323 ¹⁾ | | | | | | | |
| 2.0 Bifuel (2WD) (4WD) (GF_W, GG_W) 2.3 Di-D (4WD) 3.0 (169 kW) (4WD) 3.0 GT (167 kW) (4WD) | 12.13 - 12.13 - 3.14- 2.15 12.13 - | | 3350037 L 3350036 R | | | | | | |
| | | 910323 ¹⁾ | | | | | | | |
| 3.0 (169 kW) (4WD) (GF_W, GG_W) 2.2 Di-D (132 kW) (4WD) | 3.15 - | | 3350037 L 3350036 R | | | 3410059 | | | |
| | | 910323 ¹⁾ | | | | | | | |
| 2.0 Hybrid (4WD) (GG2W) | 12.12- 6.15 | | 3340212 L 3340211 R | | | 3410078 | | | |
| | | 910323 ¹⁾ | | | | | | | |
| 2.0 Hybrid (4WD) (GG2W) | 7.15- 12.16 | | 3350037 L 3350036 R | | | | | | |
| | | 910323 ¹⁾ | | | | | | | |
| 2.0 Hybrid (4WD) (GG2W, GG3W) 2.4 Hybrid (4WD) | 1.17 - | | 3350037 L 3350036 R | | | | | | |
| | | 910323 ¹⁾ | | | | | | | |
| 1) → 3.18: Exc. → 8.18: ⊕ | | | | | | | | | |
| Pajero / Shogun / Montero | | | | | | | | | |
| Pajero I / Shogun I / Montero I = | | 444067 | 344119 | 554061 ▼ | | 443198 | 343239 | | |
| 2.6 (L042G, L047G) | 1.83 - 91 | | | | | | | | |
| 2.3 Diesel (L043G, L048G) | 1.83 - 4.86 | | | | | | | | |
| 2.5 Diesel, 2.5 TD (L044G, L049G) | 5.86 - 91 | | | | | | | | |
| Pajero I / Shogun I / Montero I = | 11.88- 91 | 444067 | 344119 | 554061 ▼ | | | 344116 | 554068 ▼ | |
| 3.0 (L141G, L146G) | | | | | | | | | |
| 2.5 Diesel, 2.5 TD (L144G, L149G) | | | | | | | | | |



Mitsubishi

| MODEL FAHRZEUG MODELE | YEAR JAHR ANNEE | FRONT/VORNE/AVANT | | | | REAR/HINTEN/ARRIERE | | | |
|--|-----------------------|-----------------------------|-----------------------------|--------------------------------|--|-----------------------------|-----------------------------|--------------------------------|--|
| | | PREMIUM Twin-tube Oil | EXCEL-G Twin-tube Gas | GAS-A-JUST Mono-tube Gas | | PREMIUM Twin-tube Oil | EXCEL-G Twin-tube Gas | GAS-A-JUST Mono-tube Gas | |
| Mitsubishi (J) | | | | | | | | | |
| Pajero / Shogun / Montero | | | | | | | | | |
| Pajero II / Shogun II / Montero II = 2.6 (V12V, V32W) 2.5 D/DT (V14C, V14V, V34V) 2.8 D (V36V) | 4.91 - | 444139 | 344222 | 554091 | | 443198 | 343239 | | |
| Pajero II / Shogun II / Montero II = 2.4 (V21C, V21W, V41W) 3.0 (V23C, V23W, V43W) 3.5 V6 (V25W, V45W) 2.5 DT (V24C, V24W, V44W) 2.8 DT (V26W, V46W) Exc. | 12.90 - 4.00 | | 344222 | 554091 | | | 344223 | 554092 | |
| Pajero III / Shogun III / Montero III 3.0 (V73W) 3.5 (V65W, V75W) 2.5 TD (V64W, V74W) 3.2 TD (V68W, V78W) 3.2 DI-D (V60) | 2.00 - 1.07 | | 341251 | | | | 344300 | | |
| Pajero IV / Shogun IV / Montero IV 3.8 V6 (V8_, V9_) 3.2 DI-D | 2.07 - | | 341445 | | | | 349057 | | |
| Pajero Pinin | | | | | | | | | |
| | 99 - | | 334813 | | | | 343802 | | |
| Pajero Sport / Montero Sport | | | | | | | | | |
| Pajero Sport I, Montero Sport I 3.0 (K96W) 2.5 TD (K94W) | 8.98 - | | 344294 | | | | 344295 | | |
| Pajero Sport II, Montero Sport II 2.5 DI-D (131 kW) (KH4W) 3.0 (162 kW) (KH_, KG_) 3.2 DI-D (121 kW) (KH_, KG_) 3.2 DI-D HPE FULL GPS (KH_, KG_) | 7.08 - | | 340034 | | | | 349090 | | |
| Pajero Sport III, Montero Sport III 2.4 DI-D, 3.0 (KS_) | 8.15 - | | | | | | 349090 | | |
| Santamo | | | | | | | | | |
| | 99 - | 634042 | 334070 | | | 443265 | 343262 | | |
| | 99 - | 634043 | 334071 | | | 443265 | 343262 | | |
| Sigma | | | | | | | | | |
| 3.0 V6 (F16A) Exc. ECS | 12.90 - 7.96 | | 335017 | | | | 341134 | | |



| MODEL FAHRZEUG MODELE | YEAR JAHR ANNEE | FRONT/VORNE/AVANT | | | | REAR/HINTEN/ARRIERE | | | |
|---|----------------------------|-----------------------------|-----------------------------|--------------------------------|--|-----------------------------|-----------------------------|--------------------------------|--|
| | | PREMIUM Twin-tube Oil | EXCEL-G Twin-tube Gas | GAS-A-JUST Mono-tube Gas | | PREMIUM Twin-tube Oil | EXCEL-G Twin-tube Gas | GAS-A-JUST Mono-tube Gas | |
| Mitsubishi (J) | | | | | | | | | |
| Sigma | | | | | | | | | |
| 3.0 V6 Exc. ECS (🚫) | (F07W) | 1.93 - 7.96 | | 335017 | | | 344352 | | |
| Space Runner | | | | | | | | | |
| (2WD) 1.8, 2.0 TD (N11W, N18W) | | 9.91 - 8.99 | 634042 | 334070 | | 443265 | 343262▼ | | |
| | | | | SM3302▼ | | | | | |
| (4WD) 1.8 (N21W) | | 9.91 - 8.99 | 634043▼ | 334071 | | 443265 | 343262▼ | | |
| | | | | SM3302▼ | | | | | |
| (2WD) 2.0 2.4 (N63) (N64) | | 8.99 - 02 | | 334328 L 334327 R | | | 343387 | | |
| Space Star | | | | | | | | | |
| 1.3 Exc. | (DG1A) | 6.98 - 6.00 | | 333281 L 333280 R | | | 341204 | | |
| | | | | | | 910331 | | | |
| 1.8 | (DG5A) | 6.98 - 6.00 | | 334248 L 334247 R | | | 341204 | | |
| | | | | | | 910331 | | | |
| ALL Exc. | | 7.00 - | | 334309 L 334308 R | | | 341204 | | |
| | | | | | | 910331 | | | |
| ALL | | 7.00 - | | | | | 341345 | | |
| | | | | | | 910331 | | | |
| Space Wagon, Space Van (Chariot), Expo | | | | | | | | | |
| (2WD) 1800 (D0 5W, D0 5V), 2000 (D0 4W) 1800 Turbo Diesel (D0 9W, D0 9V) | | 1.83 - 91 | 634001 | | | | 343212 | | |
| | | | | 913271 | | | | | |
| (4WD) 2000 (D0 8W) | | 3.85 - 91 | | 334033▼ | | | 343212 | | |
| | | | | | | | | | |
| (2WD) 1.8, 2.0, 2.4, 1.8 TD, 2.0 TD (N31W, N33W, N34W, N35W, N38W) Exc. | | 9.91 - 11.00 | 634042 | 334070 | | 443265 | 343262▼ | | |
| | | | | SM5195 | | | | | |
| (2WD) 2.0 | (N33W) | 9.91 - 11.00 | 634043▼ | 334071 | | | | | |
| | | | | SM5195 | | | | | |
| (4WD) 1.8, 2.0 (N41W, N43W) | | 9.91 - 11.00 | 634043▼ | 334071 | | 443265 | 343262▼ | | |
| | | | | SM5195 | | | | | |
| (2WD) 2.4 (4WD) 2.4 (N84W) (N94W) | | 6.98 - 5.00 | | 334236 L 334235 R | | | 343312 | | |
| | | | | | | | | | |
| (2WD) 2.0 (2WD) 2.4 (4WD) 2.4 Exc. | (N83W) (N84W) (N94W) | 6.00 - | | 334393 L 334392 R | | | 343312 | | |
| | | | | | | | | | |



Mitsubishi

| MODEL FAHRZEUG MODELE | YEAR JAHR ANNEE | FRONT/VORNE/AVANT | | | | REAR/HINTEN/ARRIERE | | | |
|--|-----------------------|-----------------------------|-----------------------------|--------------------------------|--|-----------------------------|-----------------------------|--|--|
| | | PREMIUM Twin-tube Oil | EXCEL-G Twin-tube Gas | GAS-A-JUST Mono-tube Gas | | PREMIUM Twin-tube Oil | EXCEL-G Twin-tube Gas | GAS-A-JUST Mono-tube Gas | |
| Mitsubishi Commercial (J) | | | | | | | | | |
| Canter FB Series | | | | | | | | | |
| FB100, FB120 | 11.80 - 85 | 444148 | | | | 444157 | | | |
| FB300 | 1.86 - | 444148 | | | | 444157 | | | |
| FB431, FB433, FB436 | 1.86 - 96 | 444149 | | | | 444157 | | | |
| FB631 | 5.96 - | 441101 | | | | 444157 | | | |
| Canter FC Series | | | | | | | | | |
| FC432 | 1.86 - 90 | 444149 | | | | 444109 | | | |
| Canter FE Series | | | | | | | | | |
| FE100, FE101 | 11.78 - 82 | 444148 | | | | | O.E. = MT 116015 | | |
| FE100, FE101 | 10.82 - 85 | 444148 | | | | 444157 | | O.E. = MB 161539, MB 161554, MB 161556 | |
| FE111 | 11.78 - 82 | 444148 | | | | 444109 | | O.E. = MT 160820 | |
| FE111 | 11.78 - 82 | 444148 | | | | 444109 | | O.E. = MT A60820 | |
| FE111 Exc. | 11.78 - 82 | 444148 | | | | | | O.E. = MT 160854 | |
| FE111 -B, -BD, -BDT, -BZE, -BZEC FE114 -B, -BD, -BDT, -BG | 10.82 - 85 | 444148 | | | | 444157 | | O.E. = MB 161539, MB 161554, MB 161556 | |
| FE111 -BG, -BN, -BN1, -BNFW FE114 -BN, -BNFW, -BDN3, -BDN3K | 10.82 - 85 | 444148 | | | | | | O.E. = MB 1161553 | |
| FE111 -BZ, -BZ1, -BZB FE111 -E, -EW, -EZ, -EZC, -EZCW FE114 -BZ, -E, -EW, -EZ, -EZC, -EZCW | 10.82 - 85 | 444148 | | | | 444109 | | O.E. = MB 161555 | |
| FE120, FE121 | 11.78 - 85 | 444148 | | | | 444157 | | | |
| FE131, FE134 | 11.78 - 85 | 444148 | | | | 444109 | | | |
| FE211, FE214, FE231, FE234 | 11.78 - 85 | 444149 | | | | 444109 | | | |
| FE221, FE224 | 2.80 - 85 | 444149 | | | | 444157 | | | |
| FE331 | 1.86 - 96 | 444148 | | | | 444109 | | | |
| FE431, FE441, FE444 | 1.86 - 96 | 444149 | | | | 444109 | | | |



| MODEL FAHRZEUG MODELE | YEAR JAHR ANNEE | FRONT/VORNE/AVANT | | | | | REAR/HINTEN/ARRIERE | | | | |
|--|--|-----------------------------|-----------------------------|--------------------------------|--|--|--------------------------------|-----------------------------|--|--|--|
| | | PREMIUM Twin-tube Oil | EXCEL-G Twin-tube Gas | GAS-A-JUST Mono-tube Gas | | | PREMIUM Twin-tube Oil | EXCEL-G Twin-tube Gas | GAS-A-JUST Mono-tube Gas | | |
| Mitsubishi Commercial (J) | | | | | | | | | | | |
| Canter FE Series | | | | | | | | | | | |
| FE531 | 5.96 - | 444149 | | | | | 444109 | | | | |
| FE649 | 5.96 - | 444148 | | | | | 444109 | | | | |
| Canter FH Series | | | | | | | | | | | |
| FH100 | 2.88 - | 444149 | | | | | | | | | |
| Delica, T Series | | | | | | | | | | | |
| T 100/T 100 V/T 120/T 120 V/T 121 Series | 68 - 6.79 | 444022 | | 554046 | | | | | 553116 ¹⁾ 553106 ²⁾ ▼ | | |
| 1) O.E. = MT 141620, MA 410923B, A 410923, MB 003595, MB 515566 2) O.E. = MT 141622 | | | | | | | | | | | |
| L 200 | | | | | | | | | | | |
| (2WD) (L0 21P/22 P) | 6.78 - 86 | 443189 | 343202▼ | 553115 | | | 443292 | | | | |
| (4WD) (L0 22 G) | 10.80 - 86 | | | | | | 443290 | 343292 | | | |
| (2WD) 1600 (K 11 T) 2000 (K 12 T) 2400 (K 15 T) 2500 Diesel (K 14 T) | 4.87 - 10.96 11.86 - 10.96 11.86 - 10.96 | 443189 | 343202▼ | 553115 | | | 443292 | | | | |
| (4WD) 2000 (K 22 T/K 32 T) 2400 (K 35 T) 2600 (K 33 T) 2500 Diesel (K 24 T/K 34 T) | 11.86 - 10.96 12.89 - 10.96 1.88 - 10.96 | 444117 | 344221▼ | 554074 | | | 443290 | 343292 | | | |
| (2WD) 2000 (K 62 T) 2400 (K 65 T) 2500 Diesel (K 64 T) 2500 Turbo Diesel (K 64 T) | 1.96 - | | 344389 | | | | 443292 | | | | |
| (4WD) 2400 (K 75 T) 2500 Diesel (K 74 T) 2500 Turbo Diesel (K 74 T) | 1.96 - 3.03 | 444150 | 344346 | 554105 | | | 443290 | 343292 | 553222 | | |
| 2.5 DI-D | 5.06 - | | 340033 | | | | 443258 | 343251 | 553189 | | |
| L 300 / Delica | | | | | | | | | | | |
| (2WD) 1.6 (L032P, L062P) 2.3 D (L038P, L068P) | 6.79 - 5.86 | 444022 | | 554046 | | | 443149 443150 ¹⁾ | 343213 | 553116 553143 ¹⁾ | | |
| 1) O.E. = MB 515568 | | | | | | | | | | | |



Moskwitch

| MODEL FAHRZEUG MODELE | YEAR JAHR ANNEE | FRONT/VORNE/AVANT | | | | REAR/HINTEN/ARRIERE | | | |
|-----------------------------|-----------------------|-----------------------------|-----------------------------|--------------------------------|--|-----------------------------|-----------------------------|--------------------------------|--|
| | | PREMIUM Twin-tube Oil | EXCEL-G Twin-tube Gas | GAS-A-JUST Mono-tube Gas | | PREMIUM Twin-tube Oil | EXCEL-G Twin-tube Gas | GAS-A-JUST Mono-tube Gas | |

Mitsubishi Commercial (J)

L 300 / Delica

| | | | | | | | | | |
|--|-------------|---------|---------|--------|--|--------|---------|--------|--|
| 1.6 (L032P) 2.3 D (L038P) | 6.79 - 5.86 | 444022 | | 554046 | | | | | |
| 1.8 (L035G) 2.0 (L037G) | 83 - 5.86 | 444068 | | | | | | | |
| 1.4 (P01W) 1.6 (P02V, P12W/V) 2.0 (P03W/V, P13V) 2.4 (P04W/V, P14V) 2.5 D (P05W/V, P15W/V) | 6.86 - | 444089 | 344064▼ | 554062 | | 443223 | 343200▼ | | |
| 2.0 (P23W, P23V) 2.4 (P24W, P24V) 2.5 D (P25W, P25V) 2.5 DT (P45V) | 6.86 - | 444090▼ | 344111 | | | 443224 | 343226 | | |
| 1.6 (L032P) 2.5 D (L039P) | 6.86 - 8.94 | 444022 | | 554046 | | 443150 | | 553143 | |
| 2.0 (P13T) 2.5 DT (P15T) | 6.94 - | 444137 | | 554102 | | 443149 | 343213 | 553116 | |

Space Gear, L 400

| | | | | | | | | | |
|---|--------------|--------|--|--------|--|--------|--|---------|--|
| 2.0, 2.4, 2.5 DT (PA3W, PA4W, PA5W) | 12.94 - 6.05 | 444137 | | 554102 | | 443283 | | 553210▼ | |
| 2.0, 2.4, 2.5 DT (PA3V/5V, PB3V/5V) | 12.94 - 6.05 | 444137 | | 554102 | | 443285 | | 553193 | |
| 2.4, 2.5 DT (PD4W, PD5W) | 12.94 - 6.05 | 444138 | | 554103 | | 443284 | | 553211 | |
| 2.4, 2.5 DT (PD4V, PD5V) | 12.94 - 6.05 | 444138 | | 554103 | | 443286 | | | |

Moskwitch (RUS)

2141

| | | | | | | | | | |
|------|------|--|----------------------|--|--|--|--------|--|--|
| 2141 | 87 - | | 365800 ¹⁾ | | | | 344277 | | |
|------|------|--|----------------------|--|--|--|--------|--|--|

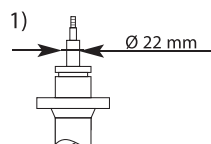



| MODEL FAHRZEUG MODELE | YEAR JAHR ANNEE | FRONT/VORNE/AVANT | | | REAR/HINTEN/ARRIERE | | | |
|--|-----------------------|-----------------------------|--------------------------------|--|--|--|-----------------------------|--------------------------------|
| | | PREMIUM Twin-tube Oil | EXCEL-G Twin-tube Gas | GAS-A-JUST Mono-tube Gas | | PREMIUM Twin-tube Oil | EXCEL-G Twin-tube Gas | GAS-A-JUST Mono-tube Gas |
| Nissan (J) | | | | | | | | |
| 100 NX | | | | | | | | |
| 1600 ⊖ ABS | (B 13) | 10.90 - 2.94 | 633116 L 633115 R | 333090 L 333089 R | 634037 L ¹⁾ ▼ 634036 R ¹⁾ ▼ | 334046 L ¹⁾ 334045 R ¹⁾ | | |
| | | | ☞ 913138▼ ☞ SM5153 | | | | | |
| 1600 ⊖ ABS | (B 13) | 3.94 - 95 | 633116 L 633115 R | 333090 L 333089 R | 632073 L ²⁾ 632072 R ²⁾ | 332057 L ²⁾ 332056 R ²⁾ | | |
| | | | ☞ 913138▼ ☞ SM5153 | | ☞ SM5085▼ | | | |
| 1600 ⊕ ABS | (B 13) | 10.90 - 95 | 633116 L 633115 R | 333090 L 333089 R | 634039 L▼ 634038 R▼ | 334048 L 334047 R | | |
| | | | ☞ 913138▼ ☞ SM5153 | | ☞ SM5085 ³⁾ ▼ | | | |
| 2000 Incl. ABS | (B 13) | 10.90 - 95 | 633116 L 633115 R | 333090 L 333089 R | 634039 L▼ 634038 R▼ | 334048 L 334047 R | | |
| | | | ☞ 913138▼ ☞ SM5153 | | ☞ SM5085 ³⁾ ▼ | | | |
| 1) 2) 3) 3.94 - 95 | | | | | | | | |
| Almera (N15) | | | | | | | | |
| <u>2WD</u> 1.4, 1.6, 2.0 GTI, 2.0 Diesel Incl. ABS | (N15) | 7.95 - 7.97 | | 333193 L ¹⁾ 333192 R ¹⁾ | | 341186 ³⁾ | | |
| | | | ☞ 910032▼ ☞ SM5153 ☞ 910350 | | ☞ 910036▼ ☞ SM5123 ☞ 910353 | | | |
| <u>2WD</u> 1.4, 1.6, 2.0 GTI, 2.0 Diesel Incl. ABS | (N15) | 8.97 - 12.99 | | 333239 L ²⁾ 333238 R ²⁾ | | 341226 ⁴⁾ | | |
| | | | ☞ 910032▼ ☞ SM5153 ☞ 910350 | | ☞ 910036▼ ☞ SM5123 ☞ 910353 | | | |
| 1) 2) 3) 4) | | | | | | | | |
| Almera (N16E) | | | | | | | | |
| 1.5, 1.8, 2.2 Di | (N16E) | 1.00 - 7.00 | | 333309 L 333308 R | | 341282 | | |
| | | | ☞ 910033 ☞ SM5216 | | ☞ 910037 ☞ SM9808 | | | |
| 1.5, 1.8, 2.2 Di 1.5 dCi 2.2 dCi | (N16E) | 8.00 - | | 333311 L 333310 R 323062 L 323061 R | | 341282 351028 | | |
| | | | ☞ 910033 ☞ SM5216 | | ☞ 910037 ☞ SM9808 | | | |



| MODEL FAHRZEUG MODELE | YEAR JAHR ANNEE | FRONT/VORNE/AVANT | | | | REAR/HINTEN/ARRIERE | | | |
|---|-----------------------|-----------------------------|--|--------------------------------|--|-----------------------------|-----------------------------|--------------------------------|--|
| | | PREMIUM Twin-tube Oil | EXCEL-G Twin-tube Gas | GAS-A-JUST Mono-tube Gas | | PREMIUM Twin-tube Oil | EXCEL-G Twin-tube Gas | GAS-A-JUST Mono-tube Gas | |
| Nissan (J) | | | | | | | | | |
| Almera (N16) | | | | | | | | | |
| 1.5, 1.8, 2.2 Di (N16) | 4.00 - 7.00 | | 333309 L 333308 R | | | 341279 | | | |
| | | 910033 | SM5216 | | | 910037 | SM9808 | | |
| 1.5, 1.8, 2.2 Di (N16) | 8.00 - 2.01 | | 333311 L 333310 R | | | 341279 | | | |
| | | 910033 | SM5216 | | | 910037 | SM9808 | | |
| 1.5, 1.5 DCi, 1.8, 2.2 Di 2.2 dCi (N16) | 3.01 - | | 333311 L 333310 R 323062 L 323061 R | | | 341282 351028 | | | |
| | | 910033 | SM5216 | | | 910037 | SM9808 | | |
| Almera Classic | | | | | | | | | |
| 1.6 (B10) | 06 - | | 333311 L 333310 R | | | 341279 | | | |
| | | 910033 | SM5216 | | | 910037 | | | |
| Almera Tino (V10) | | | | | | | | | |
| 1.8 (V10) | 5.00 - 10.00 | | 333323 L 333322 R | | | 341283 | | | |
| | | 910034▼ 910351 | SM5409 | | | 910037 | SM9808 | | |
| 1.8 (V10) | 11.00 - | | 333327 L 333326 R | | | 341283 | | | |
| | | 910034▼ 910351 | SM5409 | | | 910037 | SM9808 | | |
| 2.0 (V10) | 5.00 - | | | | | 341283 | | | |
| | | 910034▼ 910351 | SM5409 | | | 910037 | SM9808 | | |
| 2.2 Di 2.2 dCi (V10) | 5.00 - | | 333323 L 333322 R | | | 341283 | | | |
| | | 910034▼ 910351 | SM5409 | | | 910037 | SM9808 | | |
| Bluebird, Bluebird U | | | | | | | | | |
| (J 910, PJ 910, YJ 910) 160 B, 180 B | 11.79 - 9.83 | | 364003 | | | | | | |
| 180 B (WJ 910) | 1.82 - 9.83 | | | | | 443285 | | 553193 | |
| 180 B Diesel (VJ 910) | 11.79 - 9.83 | | 364003 | | | | | | |
| 180 B Turbo Diesel (EJ 910) | 12.82 - 9.83 | | 364003 | | | | | | |
| 1800, 1800 Turbo, 2000 | 11.83 - 1.86 (U 11) | | | | | 664016 ⁽¹⁾ | | | |



| MODEL FAHRZEUG MODELE | YEAR JAHR ANNEE | FRONT/VORNE/AVANT | | | | REAR/HINTEN/ARRIERE | | | |
|---|-----------------------|--|-----------------------------|--------------------------------|---|-----------------------------|-----------------------------|--------------------------------|------------------|
| | | PREMIUM Twin-tube Oil | EXCEL-G Twin-tube Gas | GAS-A-JUST Mono-tube Gas | | PREMIUM Twin-tube Oil | EXCEL-G Twin-tube Gas | GAS-A-JUST Mono-tube Gas | |
| Nissan (J) | | | | | | | | | |
| Bluebird, Bluebird U | | | | | | | | | |
| (U 11) 2000 Diesel, 2000 Diesel Turbo | 11.83- 1.86 | | | | | 664016 ¹⁾ | | | |
| (U 11) 2000i | 1.86- 90 | 634028 L ²⁾ ▼ 634027 R ²⁾ ▼ | | | | 664020 ³⁾ | | | |
| (U 11) 2000 Diesel | 1.86- 90 | 634082 L ⁴⁾ ▼ 634081 R ⁴⁾ ▼ | | | | 664020 ³⁾ | | | |
| (T 12:) 1600, 1800, 2000 Exc. 1800 Turbo, | 12.85- 2.90 | | | | | 664020 | | | |
| (T 12:) 2000 Diesel | 12.85- 2.90 | | | | | 664020 | | | |
| (T 72:) 1600, 1800, 2000 Exc. 1800 Turbo, | 7.86- 4.90 | | | | | 664020 | | | |
| (T 72:) 2000 Diesel | 7.86- 4.90 | | | | | 664020 | | | |
| 1) 664016 : O.E. = 55302/03-10E26/-10E29/-11E25/-11E27/-10E25 | | | | | 3) 664020 : O.E. = 55302/03-D4027, 56205-D4027/-D4126 | | | | |
| 2) 634027 : O.E. = 54302-24E26 634028 : O.E. = 54303-24E26 | | | | | 4) 634081 : O.E. = 54302-14E27 634082 : O.E. = 54303-14E27 | | | | |
| Cherry, Pulsar | | | | | | | | | |
| 100 A, 120 A | (E10) 9.70- 9.74 | | | | | | | 552001 | |
| 100 AF II, 120 AF II | (F 10, 11) 9.74- 7.78 | | | | | | | 552001 | |
| 120 A, 140 A | (N10) 4.78- 5.82 | | | | | | | 552001 | |
| Exc. 1500 Turbo, Cherry Europe (Alfa 33 sus.) | (N 12) 5.82- 5.86 | | | | | | 342008 | 552010▼ | |
| Exc. , 1800 16V | (N 13) 6.86- 9.90 | 632041 L 632040 R | 332029 L 332028 R | | | 632047 L 632046 R | 332027 L 332026 R | | |
| | | 913138▼ SM5327▼ | | | | 912020 SM5048 | | | |
| 1600 | (NN13) 6.86- 9.90 | | | | | | 333054 L▼ 333053 R▼ | | |
| | | 913138▼ SM5327▼ | | | | SM5048 | | | |
| Cube | | | | | | | | | |
| | (Z12) 3.10- | | | | | | | | |
| | | | | | | | | | MB1509 |
| Fair Lady, 280 ZX, 300 ZX, 350 ZX | | | | | | | | | |
| 3.0, 3.0 Turbo Exc. | (Z31) 10.83- 89 | | 365098 | | | | | 554104 | |
| | | | | | | | | | SM5502▼ SM5325▼ |



| MODEL FAHRZEUG MODELE | YEAR JAHR ANNEE | FRONT/VORNE/AVANT | | | | REAR/HINTEN/ARRIERE | | | |
|--|----------------------------------|-----------------------------|-----------------------------|--------------------------------|--|-----------------------------|-----------------------------|--------------------------------|--|
| | | PREMIUM Twin-tube Oil | EXCEL-G Twin-tube Gas | GAS-A-JUST Mono-tube Gas | | PREMIUM Twin-tube Oil | EXCEL-G Twin-tube Gas | GAS-A-JUST Mono-tube Gas | |
| Nissan (J) | | | | | | | | | |
| Fair Lady, 280 ZX, 300 ZX, 350 ZX | | | | | | | | | |
| 350 ZX 3.5 V6 3.5 V6 | (Z33) 7.03 - 09 12.04 - 09 | | 341367 L 341366 R | | | 344455 | | | |
| SM5482 | | | | | | | | | |
| Juke | | | | | | | | | |
| | 6.10 - | | 339755 L 339754 R | | | 344816 | | | |
| SM1016 L SM1017 R SM9915 | | | | | | | | | |
| 1) → 9.14 | | | | | | | | | |
| Junior | | | | | | | | | |
| Junior | (140, N 140) | 70 - | | | | 444026 | | | |
| Laurel | | | | | | | | | |
| 2.0, 2.4 E, 2.8 Diesel | (C 32) | 11.84 - 2.90 | 665058 ▼ | 365073 | | 341052 ▼ | | | |
| 2.4, 3.0 Exc. | (C 32) | 3.86 - | 665058 ▼ | 365073 | | 341051 ▼ | | | |
| 2.4, 3.0 | (C 32) | 3.86 - | 665058 ▼ | 365073 | | | | | |
| Leaf (ZE0) | | | | | | | | | |
| | (ZE0) | 11.10 - | | 339407 L 339406 R | | 349216 | | | |
| SM1016 L SM1017 R SM1016 L SM1017 R 912031 | | | | | | | | | |
| Leaf (ZE1) | | | | | | | | | |
| Electric (110 kW) | (ZE1) | 8.17 - | | 339407 L 339406 R | | | | | |
| SM1016 L SM1017 R | | | | | | | | | |
| Maxima, QX | | | | | | | | | |
| Incl. ABS | (J 30) | 12.88 - 10.94 | | 334159 L 334158 R | | 365079 | | | |
| SM5503 | | | | | | | | | |
| | (A 32) | 10.94 - 12.99 | | 334481 L 334480 R | | 341202 | | | |
| SM5122 SM5123 | | | | | | | | | |
| | (CA 33) | 1.00 - 7.00 | | 334266 L 334265 R | | 341271 | | | |
| SM5409 SM5217 | | | | | | | | | |



| MODEL FAHRZEUG MODELE | YEAR JAHR ANNEE | FRONT/VORNE/AVANT | | | | REAR/HINTEN/ARRIERE | | | |
|--|-----------------------|-----------------------------|--|--------------------------------|--|-----------------------------|-----------------------------|--------------------------------|--|
| | | PREMIUM Twin-tube Oil | EXCEL-G Twin-tube Gas | GAS-A-JUST Mono-tube Gas | | PREMIUM Twin-tube Oil | EXCEL-G Twin-tube Gas | GAS-A-JUST Mono-tube Gas | |
| Nissan (J) | | | | | | | | | |
| Maxima, QX | | | | | | | | | |
| (CA 33) | 8.00 - | | 334367 L 334366 R | | | | 341341 | | |
| | | | SM5409 | | | | SM5217 | | |
| Micra, March | | | | | | | | | |
| Micra I Exc. Turbo | (K10) 12.82 - 11.92 | 632011 L 632078 R | | | | 441043 | 341056▼ | | |
| Micra II | (K11) 8.92 - 12.02 | 632080 L 632079 R | 332062 L 332061 R | | | 443255 | 343249 | | |
| | | 910031 | SM2807 | | | | | | |
| Micra III, March III 1.0 i 16V 1.2 i 16V 1.4 i 16V 1.5 dCi 160 SR | (K12) 1.03 - 6.10 | | 333722 L 333721 R | | | | 343807 | | |
| | | 912025 | MB1509 SM1526 L SM1527 R | | | | | | |
| Micra IV, March IV 1.2, 1.2 DIG, 1.2 LPG | (K13) 5.10 - | | 332149 L 332148 R | | | | 348063 | | |
| | | | SM5839 | | | | SM5836 | | |
| Micra V | (K14) 12.16 - | | 3338048 L 3338047 R | | | | | 5528000 | |
| Micra C+C | | | | | | | | | |
| (K12) | 8.05 - | | | | | | | | |
| | | | MB1509 SM1526 L SM1527 R | | | | | | |
| Murano I | | | | | | | | | |
| 3.5 i 16V | (Z50) 3.05 - | | 334381 L 334380 R | | | | 344439 | | |
| | | 910035▼ 910352 | SM5409 | | | | SM5462 | | |
| Murano II | | | | | | | | | |
| 3.5 (195 kW) | (Z51) 11.07 - 9.14 | | 339189 L 339188 R | | | | 349092 | | |
| | | | SM5803 ¹⁾ SM5838 ²⁾ | | | | | | |
| 3.5 (kW : 183, 188, 191, 195) | (Z51) 11.07 - 9.14 | | 339189 L 339188 R | | | | 349092 | | |
| | | | SM5803 ¹⁾ SM5838 ²⁾ | | | | | | |
| 1) →7.13 2) 7.13→ | | | | | | | | | |



| MODEL FAHRZEUG MODELE | YEAR JAHR ANNEE | FRONT/VORNE/AVANT | | | | REAR/HINTEN/ARRIERE | | | |
|--|-----------------------|-----------------------------|-----------------------------|--|--------|-----------------------------|-----------------------------|--------------------------------|--|
| | | PREMIUM Twin-tube Oil | EXCEL-G Twin-tube Gas | GAS-A-JUST Mono-tube Gas | | PREMIUM Twin-tube Oil | EXCEL-G Twin-tube Gas | GAS-A-JUST Mono-tube Gas | |
| Nissan (J) | | | | | | | | | |
| Murano II | | | | | | | | | |
| (4WD) 2.5 dCi | (Z51) | 1.10 - 9.14 | | 339312 L 339311 R | | | 349092 | | |
| | | | | SM5803 ¹⁾ SM5838 ²⁾ | | | | | |
| 1) →7.13 | | 2) 7.13→ | | | | | | | |
| Note | | | | | | | | | |
| 1.4 i 16V 1.6 i 16V 1.5 dCi | (E11) | 2.06 - | | 333748 L 333747 R | | | 343810 | | |
| | | | | 912025 MB1509 SM2805 L SM2806 R | | | | | |
| 1.2, 1.2 LPG, 1.5 dCi | (E12) | 6.13 - | | 332149 L 332148 R | | | 3430043 | | |
| 1.2 DIG-S (72 kW) Acenta version Exc. Tekna /Visia version | (E12) | 6.13 - | | | | | 3430043 | | |
| 1.2 DIG-S (65 kW) | (E12) | 12.13 - | | | | | 3430043 | | |
| NV200 Evalia → See Nissan Commercial | | | | | | | | | |
| Pathfinder | | | | | | | | | |
| | (R50) | 10.97 - 1.99 | 635012 L 635011 R | 335023 L 335022 R | | 443294 | | 553229▼ | |
| | (R50) | 2.99 - 12.04 | | 335031 L 335030 R | | 443363 | | 553303▼ | |
| 2.5 dCi 4.0 V6 | (R51) | 3.05 - 9.05 - | | 341461 | | | 345056 | 555057 | |
| | | | | SM5698 | | | | | |
| Patrol / Safari | | | | | | | | | |
| Hardtop () (TR *160, KR * 160, KM * 160) | | 6.80 - 7.82 | | | | | | | |
| Wagon () (WR *160, WM * 160, CR * 160) | | 6.80 - 7.82 | | | | | | | |
| Wagon (WR *160, WM * 160, CR * 160) Hardtop (TR *160, KR * 160, KM * 160) | | 8.82 - 8.88 | 444052 | | 554037 | | 444053 | 554038 | |
| Exc. H/D (UR * 160) | | 7.81 - 6.82 | | | | | | | |
| H/D (UR* 160) | | 7.81 - 6.82 | | | | | | 554038 ¹⁾ | |
| | | | | | | | Lmax = 517 mm | | |
| | | | | | | | | Lmax = 537 mm | |
| 1) | | | | | | | | | |



| MODEL FAHRZEUG MODELE | YEAR JAHR ANNEE | FRONT/VORNE/AVANT | | | | REAR/HINTEN/ARRIERE | | | |
|--|------------------------|-----------------------------|-----------------------------|--------------------------------|--|-----------------------------|-----------------------------|--------------------------------|--|
| | | PREMIUM Twin-tube Oil | EXCEL-G Twin-tube Gas | GAS-A-JUST Mono-tube Gas | | PREMIUM Twin-tube Oil | EXCEL-G Twin-tube Gas | GAS-A-JUST Mono-tube Gas | |
| Nissan (J) | | | | | | | | | |
| Patrol / Safari | | | | | | | | | |
| (UR* 160) Exc. H/D | 7.82 - 9.85 | | | 554037 | | | Lmax = 517 mm | | |
| (UR* 160) H/D | 7.82 - 9.85 | | | 554037 | | | Lmax = 537 mm | 554038 ¹⁾ | |
| 260 () 2.8 Diesel/Turbo Diesel 3.0 Exc. Hardtop high (Armoured) (GY 260) | 3.89 - | 444129 | | 554096 | | 444130 | | 554097 | |
| Y 60 2.8 Turbo Diesel 4.2 4.2 D | 9.88 - 6.97 | | 344360 | 554112▼ | | | 345007 | 555006▼ | |
| Y 61 2.7 Turbo Diesel 2.8 Turbo Diesel 3.0 DTi, 4.8 | 10.97 - | 444159 | 344360 | 554112▼ | | 444160 | | 554113 | |
| 1) | | | | | | | | | |
| Pick-up, Cab, King Cab, Navara, NP300 | | | | | | | | | |
| (520, 521, 620 series) | 65 - 78 | 443078 | | | | 443079 | | 553096 | |
| (720 series) | 10.79 - 8.81 | 443080 | | 553088 | | 443079 | | 553096 | |
| (720 series) | 10.79 - 12.81 | 443227▼ | | 553088 | | 443079 | | | |
| (720 series) | 1.82 - 7.85 | 443227▼ | | 553088 | | 443179 | 343214▼ | | |
| (GD 21) | 9.85 - 2.98 | 443238 | | 553159 | | 443226 | | 553154 | |
| (MD 21) | 9.85 - 2.98 | 443239 | | 553152 243024▼ | | 443240 | | 553153 | |
| 2.4 i, 2.5 D 2.5 Di | 2.98 - 3.02 - 12.06 | 443238 | | 553159 | | 443226 | | 553154 | |
| 2.4 i, 2.5 Di, 2.5 TD Exc. Sport sus. Exc. SS grade (Super Sport grade) Exc. ST grade (Sport Tourism grade) | 2.98 - | 443293 | | 553228 | | 443240 | | 553153 | |
| 2.5 DCi Exc. H/D | 7.05 - | | 341684 | | | | 348027 | | |
| 2.5 DCi 2.5 DCi | 9.09 - 9.09 - 1.10 | | 341461 | | | | 348027 | | |
| | | | | SM5698 | | | | | |
| | | | | SM5698 | | | | | |



| MODEL FAHRZEUG MODELE | YEAR JAHR ANNEE | FRONT/VORNE/AVANT | | | | REAR/HINTEN/ARRIERE | | | | | |
|---|-----------------------|-----------------------------|-----------------------------|--------------------------------|--|-----------------------------|-----------------------------|--------------------------------|--|--------|--|
| | | PREMIUM Twin-tube Oil | EXCEL-G Twin-tube Gas | GAS-A-JUST Mono-tube Gas | | PREMIUM Twin-tube Oil | EXCEL-G Twin-tube Gas | GAS-A-JUST Mono-tube Gas | | | |
| Nissan (J) | | | | | | | | | | | |
| Pick-up, Cab, King Cab, Navara, NP300 | | | | | | | | | | | |
| 3.0 D V6 Incl. H/D | (D 40) | 5.10 - | | | | | | 348027 | | | |
| | | | | SM5698 | | | | | | | |
| NP300 2.5 DCi Exc. Sport sus. Exc. SS grade (Super Sport grade) Exc. ST grade (Sport Tourism grade) | (D 22) | 4.08 - | 443293 | | | 553228 | | 443240 | | 553153 | |
| Pixo | | | | | | | | | | | |
| | (UA0) | 6.09 - | | | | | | 348028 | | | |
| | | | | 332155 L 332154 R | | | | | | | |
| Prairie | | | | | | | | | | | |
| 1500, 1800 | (BM 10, PM 10) | 8.82 - 8.88 | | | | | | 443212▼ | | | |
| | | | | 910084 | | | | | | | |
| 2000, 2400 | (M11) | 10.88 - 7.94 | | | | | | 363065 | | | |
| | | | | 334161 L 334160 R | | | | | | | |
| | | | | SM5503 | | | | | | | |
| 2000, 2400 | (NM11) | 10.88 - 7.94 | | | | | | | | | |
| | | | | 334161 L 334160 R | | | | | | | |
| | | | | SM5503 | | | | | | | |
| Primera | | | | | | | | | | | |
| 1.6, 2.0 Diesel Incl. ABS | (P10) | 6.90 - 96 | | | | | | 333283 L 333282 R | | | |
| | | | | 341120 | | | | | | | |
| | | | | 916803 SM5123 | | | | 916806▼ SM5123 | | | |
| 2000 (1.6 = 1.8) Incl. ABS | (P10) | 6.90 - 96 | | | | | | 334057 L 334056 R | | | |
| | | | | 341120 | | | | | | | |
| | | | | 351013 | | | | | | | |
| | | | | 916803 SM5123 | | | | 916806▼ SM5204▼ | | | |
| 1.6, 1.8, 2.0, 2.0 Diesel Turbo Exc. 2.0 SRI, 2.0 GTI | (P11) | 6.96 - 01 | | | | | | 341227 | | | |
| | | | | 341120 | | | | | | | |
| | | | | 916803 SM5123 | | | | 910037 | | | |
| 2.0 16V SRI 2.0 16V GTI | (P11) | 6.96 - 01 | | | | | | 341228 | | | |
| | | | | 341120 | | | | | | | |
| | | | | 916803 SM5123 | | | | 910037 | | | |
| | (P12) | 1.02 - | | | | | | 341325 | | | |
| | | | | 331015 L 331014 R | | | | | | | |
| | | | | 910035▼ SM5409 910352 | | | | 910037 SM9808 | | | |

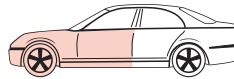

| MODEL FAHRZEUG MODELE | YEAR JAHR ANNEE | FRONT/VORNE/AVANT | | | | REAR/HINTEN/ARRIERE | | | |
|---|---|-----------------------------|-----------------------------|--------------------------------|--|-----------------------------|-----------------------------|--------------------------------|--|
| | | PREMIUM Twin-tube Oil | EXCEL-G Twin-tube Gas | GAS-A-JUST Mono-tube Gas | | PREMIUM Twin-tube Oil | EXCEL-G Twin-tube Gas | GAS-A-JUST Mono-tube Gas | |
| Nissan (J) | | | | | | | | | |
| Primera Traveller | | | | | | | | | |
| 1.6, 2.0, 2.0 Diesel (W 10) | 7.90 - 1.98 | | 332064 L 332063 R | | | | 343248 | | |
| 1.6 16V 1.8 16V 2.0 16V 2.0 Diesel Turbo 2.0 SRI (WP 11) | 1.98 - 01 | | 341120 | | | | 341228 | | |
| (WP 12) | 1.02 - | 916803 SM5123 | 331015 L 331014 R | | | 910037 | 341325 | | |
| 910035 SM5409 910352 | | | | | | 910037 SM9808 | | | |
| Pulsar | | | | | | | | | |
| 1.2 DIG-T, 1.5 dCi, 1.6 DIG-T (C13) | 10.14 - | | 3348024 L 3348023 R | | | | 3448021 | | |
| Qashqai | | | | | | | | | |
| 1.6 1.5 dCi 2.0 2.0 DCi | 12.06 - 12.06 - 12.06 - 4.07 - | | 339197 L 339196 R | | | | 349079 | | |
| 910199 SM2804 L SM2803 R | | | | | | | | | |
| Qashqai II | | | | | | | | | |
| 1.2 DIG-T, 2.0 1.5 dCi (81 kW), 1.6 dCi Exc. | (J11, J11_) 11.13 - | | 3340173 L 3340172 R | | | | 3448029 | | |
| 910365 SM1042 | | | | | | | | | |
| 1.3 DIG-T (103 kW, 118 kW), 1.6 DIG-T 1.5 dCi (85 kW) Exc. Multilink axle | (J11, J11_) 10.14 - | | 3340173 L 3340172 R | | | | 3448029 | | |
| 910365 SM1042 | | | | | | | | | |
| 1.7 dCi | (J11, J11_) 1.19 - | | 3340173 L 3340172 R | | | | 3448029 | | |
| SM1042 | | | | | | | | | |
| 1.3 DIG-T (103 kW, 118 kW), 1.6 DIG-T 1.5 dCi (85 kW), 1.7 dCi Multilink axle | (J11, J11_) 10.14 - | | 3340173 L 3340172 R | | | | 349078 | 5540008 | |
| 910365 SM1042 | | | | | | | | | |
| 1.6 dCi, 1.7 dCi, 2.0 ALL MODE (106 kW) Exc. | (J11, J11_) 11.13 - | | 3340173 L 3340172 R | | | | 349078 | 5540008 | |
| 910365 SM1042 | | | | | | | | | |
| 1) phase 1 : 1.14 → 12.17 | | | | | | | | | |
| Qashqai + 2 | | | | | | | | | |
| Exc. Russia, Ukraine (JJ10E) | 8.08 - | | 339197 L 339196 R | | | | 349079 | | |
| 910199 SM2804 L SM2803 R | | | | | | | | | |



| MODEL FAHRZEUG MODELE | YEAR JAHR ANNEE | FRONT/VORNE/AVANT | | | | REAR/HINTEN/ARRIERE | | | |
|--|-----------------------|-----------------------------|-----------------------------|--------------------------------|--|-----------------------------|-----------------------------|--------------------------------|--|
| | | PREMIUM Twin-tube Oil | EXCEL-G Twin-tube Gas | GAS-A-JUST Mono-tube Gas | | PREMIUM Twin-tube Oil | EXCEL-G Twin-tube Gas | GAS-A-JUST Mono-tube Gas | |
| Nissan (J) | | | | | | | | | |
| Qashqai + 2 | | | | | | | | | |
| For Russia, Ukraine | (JJ10E) | 8.08 - | | 339197 L 339196 R | | | 349078 | | |
| | | | 910199 | SM2804 L SM2803 R | | | | | |
| Sentra | | | | | | | | | |
| 1.6 | (B17R) | 8.14 - | | 3348024 L 3348023 R | | | 3448026 | | |
| | | | 910252 | | | | | | |
| Serena | | | | | | | | | |
| 1.6 2.0 Diesel Exc. SGX | (C23) | 7.92 - 7.92 - 10.95 | 634075 L 634074 R | 334143 L 334142 R | | 443149 | 343213 | 553116 | |
| | | | 935308 | SM5153 | | | | | |
| 2.3 Diesel Exc. SGX | (C23) | 11.95 - | 634075 L 634074 R | 334143 L 334142 R | | 443149 | 343213 | 553116 | |
| | | | 935308 | SM5153 | | | | | |
| 2.0 Diesel SGX Incl. ABS | (C23) | 7.92 - 10.95 | 634075 L 634074 R | 334143 L 334142 R | | 444131 | | | |
| | | | 935308 | SM5153 | | | | | |
| 2.3 Diesel SGX Incl. ABS | (C23) | 11.95 - 5.96 | 634075 L 634074 R | 334143 L 334142 R | | 444131 | | | |
| | | | 935308 | SM5153 | | | | | |
| 2.0 (=) SLX, SGX Incl. ABS | (C23) | 7.92 - 5.96 | 634075 L 634074 R | 334143 L 334142 R | | 444131 ¹⁾ | | | |
| | | | 935308 | SM5153 | | | | | |
| 2.0 (=) SE Incl. ABS | (C23) | 6.96 - 00 | 634075 L 634074 R | 334143 L 334142 R | | 444158 ²⁾ ▼ | | 554111 ²⁾ ▼ | |
| | | | 935308 | SM5153 | | | | | |
| 1), 2) 1) 444131, 554098 : W = 32 mm 2) 444158, 554111 : W = 42 mm | | | | | | | | | |
| Silvia, 200 SX | | | | | | | | | |
| | (S12) | 10.83 - 5.88 | | | | | | | |
| | | | | SM5322▼ | | | | | |
| 1.8 16V Turbo | (S13) | 9.88 - 94 | | 331005 L 331003 R | | | 341099 | | |
| | | | | SM5101 | | | SM5123 | | |
| 2.0 16V Turbo | (S14) | 94 - 00 | | 334185 L 334184 R | | | 341222 | | |
| | | | | SM5153 | | | | | |



| MODEL FAHRZEUG MODELE | YEAR JAHR ANNEE | FRONT/VORNE/AVANT | | | | REAR/HINTEN/ARRIERE | | | |
|---|-----------------------|-----------------------------|-----------------------------|--------------------------------|--|--|--|--------------------------------|--|
| | | PREMIUM Twin-tube Oil | EXCEL-G Twin-tube Gas | GAS-A-JUST Mono-tube Gas | | PREMIUM Twin-tube Oil | EXCEL-G Twin-tube Gas | GAS-A-JUST Mono-tube Gas | |
| Nissan (J) | | | | | | | | | |
| Sunny | | | | | | | | | |
| 120 Y Exc. | (B 210, 211) | 5.73 - 10.77 | | 362001 | | | | | |
| 120 Y Exc. | (KB 210, 211) | 5.73 - 10.77 | | 362001 | | | | | |
| 1300, 1500 Exc. Turbo | (B 11) | 10.81 - 9.85 | | 332008 L 332007 R | | | 342008 | 552010 ▼ | |
| | | | 910084 | SM5327 ▼ | | | | | |
| 1700 Diesel | (B 11) | 10.82 - 5.86 | | | | | 342008 | 552010 ▼ | |
| | | | 910084 | SM5327 ▼ | | | | | |
| 1500 Turbo | (B 11) | 9.82 - 5.86 | | | | | | 552010 ▼ | |
| | | | 910084 | SM5327 ▼ | | | | | |
| Exc. , 1800 16V | (B 12, N13) | 6.86 - 9.90 | 632041 L 632040 R | 332029 L 332028 R | | 632047 L 632046 R | 332027 L 332026 R | | |
| | | | 913138 ▼ | SM5327 ▼ | | 912020 | SM5048 | | |
| 1600 | (NN13) | 6.86 - 9.90 | | | | | 333054 L ▼ 333053 R ▼ | | |
| | | | | | | | SM5048 | | |
| 1400 2000 Diesel ⊖ ABS | (N14) | 10.90 - 95 | 633116 L 633115 R | 333090 L 333089 R | | 632073 L 632072 R | 332057 L 332056 R | | |
| | | | 913138 ▼ | SM5153 | | 916802 ▼ | SM5085 ▼ | | |
| 1600 ⊖ ABS | (N14) | 10.90 - 10.93 | 633116 L 633115 R | 333090 L 333089 R | | 634037 L ¹⁾ ▼ 634036 R ¹⁾ ▼ | 334046 L ¹⁾ 334045 R ¹⁾ | | |
| | | | 913138 ▼ | SM5153 | | 913231 ▼ | SM5085 ▼ | | |
| 1600 ⊖ ABS | (N14) | 11.93 - 95 | 633116 L 633115 R | 333090 L 333089 R | | 632073 L ²⁾ 632072 R ²⁾ | 332057 L ²⁾ 332056 R ²⁾ | | |
| | | | 913138 ▼ | SM5153 | | 916802 ▼ | SM5085 ▼ | | |
| 1400 1600 2000 Diesel ⊕ ABS | (N14) | 10.90 - 95 | 633116 L 633115 R | 333090 L 333089 R | | 634039 L ▼ 634038 R ▼ | 334048 L 334047 R | | |
| | | | 913138 ▼ | SM5153 | | 913231 ▼ | SM5085 ▼ | | |
| 2000 (=) Incl. ABS Exc. GTi-R (2000 Turbo : N14) | (N14) | 10.90 - 95 | 633116 L 633115 R | 333090 L 333089 R | | 634039 L ▼ 634038 R ▼ | 334048 L 334047 R | | |
| | | | 913138 ▼ | SM5153 | | 913231 ▼ | SM5085 ▼ | | |
| 1600 | (N14) | 10.90 - 95 | | 333092 L ▼ 333091 R ▼ | | | 332059 L 332058 R | | |
| | | | | | | 916802 ▼ | | | |
| 1) | | | 2) | | | | | | |
| | | | | | | | | | |
| | ∅ 51 mm | | | ∅ 45 mm | | | | | |



| MODEL FAHRZEUG MODELE | YEAR JAHR ANNEE | FRONT/VORNE/AVANT | | | | REAR/HINTEN/ARRIERE | | | |
|--|-----------------------|-----------------------------|-----------------------------|--------------------------------|--|-----------------------------|-----------------------------|--------------------------------|--|
| | | PREMIUM Twin-tube Oil | EXCEL-G Twin-tube Gas | GAS-A-JUST Mono-tube Gas | | PREMIUM Twin-tube Oil | EXCEL-G Twin-tube Gas | GAS-A-JUST Mono-tube Gas | |
| Nissan (J) | | | | | | | | | |
| Sunny Excellent | | | | | | | | | |
| 1400 (PB 210) | 5.73 - 2.76 | | 364003 | | | | | | |
| 1400 (KPB 210, KGB 211) | 5.73 - 2.76 | | 364003 | | | | | | |
| Sunny, Sunny Traveller / Q-bic | | | | | | | | | |
| 1200 ALL (VB 110, B 120) | 1.70 - 5.73 | | 362001 | | | 443066 | 343121 | | |
| 120Y Exc. (VB 210) | 5.73 - 10.77 | | 362001 | | | 443066 | 343121 | | |
| 120Y (VB 210) | 2.76 - 7.78 | | | | | 443066 | 343121 | 553083 | |
| 140Y Exc. (VB 310) | 10.77 - 9.81 | | 362001 | | | 443066 | 343121 | | |
| 140Y (VB 310) | 10.77 - 9.81 | | | | | 443066 | 343121 | | |
| 1300, 1500 (VB11, TB11) | 10.82 - 90 | | 332008 L 332007 R | | | 443229 | | | |
| 1300, 1500, 1600 (WB 11) | 10.81 - 86 | | 332008 L 332007 R | | | | 342008 | 552010▼ | |
| 1700 Diesel (WB 11) | 10.81 - 86 | | | | | | 342008 | 552010▼ | |
| 1500, 1600, 1700 Diesel Exc. (WB 12) | 6.86 - 9.90 | 632041 L 632040 R | 332029 L 332028 R | | | 632047 L 632046 R | 332027 L 332026 R | | |
| | | 913138▼ SM5327▼ | | | | 912020 SM5048 | | | |
| 1600 (WNB 12) | 6.86 - 9.90 | | | | | | 333054 L▼ 333053 R▼ | | |
| 1600 2000 Diesel 1.7 D (TAYAY 10) (TV CAY 10) | 11.90 - 11.90 - | 633116 L 633115 R | 333090 L 333089 R | | | | 343240 | | |
| | | 913138▼ SM5153 | | | | | | | |
| 1600 (TAYN Y 10) | 11.90 - | | 333092 L▼ 333091 R▼ | | | | 343241▼ | | |
| Terrano | | | | | | | | | |
| 2400 i (WD21) | 8.86 - 10.87 | | 343244 ¹⁾ ▼ | | | 443183 | 343245▼ | | |
| 2400 i, 2700 Turbo Diesel (WD21) | 10.87 - 93 | 444102 ²⁾ | 344200 ²⁾ | 554070 ²⁾ ▼ | | 443183 | 343245▼ | | |
| 1) | 2) | | | | | | | | |



| MODEL FAHRZEUG MODELE | YEAR JAHR ANNEE | FRONT/VORNE/AVANT | | | | REAR/HINTEN/ARRIERE | | | | | | | | | | | | | | | | | |
|--|-----------------------|---|-----------------------------|--------------------------------|------------------------|-----------------------------|-----------------------------|--------------------------------|--------|------------------|--------|--------------|--------|------------------|--------|--------------|--------|--------------|--------|--------------|-------------|----------------|--------------|
| | | PREMIUM Twin-tube Oil | EXCEL-G Twin-tube Gas | GAS-A-JUST Mono-tube Gas | | PREMIUM Twin-tube Oil | EXCEL-G Twin-tube Gas | GAS-A-JUST Mono-tube Gas | | | | | | | | | | | | | | | |
| Nissan (J) | | | | | | | | | | | | | | | | | | | | | | | |
| Terrano | | | | | | | | | | | | | | | | | | | | | | | |
| 3000 i Exc. | (WD21) | 8.89 - | 444102 | 344200 | 554070 ¹⁾ ▼ | | 443183 | 343245▼ | | | | | | | | | | | | | | | |
| 1) Ø 45 mm | | | | | | | | | | | | | | | | | | | | | | | |
| Terrano II | | | | | | | | | | | | | | | | | | | | | | | |
| | (R 20) | 93 - | 444102 | 344200 | 554070▼ | | 443295 | 343355 | 553230 | | | | | | | | | | | | | | |
| Tiida | | | | | | | | | | | | | | | | | | | | | | | |
| 1.6, 1.8 1.5 dCi | (C11X/SC11X) | 9.07 - | | 333391 L 333390 R | | | | 343465 | | | | | | | | | | | | | | | |
| <div style="display: flex; justify-content: space-around;"> SM5627 L SM5626 R SM5837 </div> | | | | | | | | | | | | | | | | | | | | | | | |
| Violet, Stanza, Auster | | | | | | | | | | | | | | | | | | | | | | | |
| 140 J, 160 J Incl. SSS | (A11) | 7.77 - 6.81 | | 364003 | | | | | | | | | | | | | | | | | | | |
| 140J | (VA 11) | 7.77 - 6.81 | | 364003 | | | | | | | | | | | | | | | | | | | |
| | (T11) | 6.81 - 9.85 | | | | | 664012 | | | | | | | | | | | | | | | | |
| X-Trail (T30) | | | | | | | | | | | | | | | | | | | | | | | |
| | (T30) | 7.01 - 5.07 | | 334361 L 334360 R | | | | 334363 L 334362 R | | | | | | | | | | | | | | | |
| <div style="display: flex; justify-content: space-around;"> 910034▼ SM5409 910038▼ SM9919 </div> <div style="display: flex; justify-content: space-around;"> 910351 910354 </div> | | | | | | | | | | | | | | | | | | | | | | | |
| X-Trail (T31) | | | | | | | | | | | | | | | | | | | | | | | |
| 2.0 (103 kW) 2.0 (104 kW) 2.0 (104 kW) 2.5 (124 kW) 2.0 dCi | (T31) | 6.08 - 11.13 3.07 - 11.13 6.07 - 1.13 6.07 - 1.12 6.07 - 1.12 | | 339199 L 339198 R | | | | | | | | | | | | | | | | | | | |
| <div style="display: flex; justify-content: space-around;"> 910199¹⁾ MB1509 SM1546 L SM1545 R </div> | | | | | | | | | | | | | | | | | | | | | | | |
| 2.0 (104 kW) 2.5 (124 kW) 2.0 dCi | (T31) | 2.13 - 11.13 2.12 - 11.13 2.12 - 11.13 | | 3340034 L 3340033 R | | | | | | | | | | | | | | | | | | | |
| <div style="display: flex; justify-content: space-around;"> 910199¹⁾ MB1509 SM1546 L SM1545 R </div> | | | | | | | | | | | | | | | | | | | | | | | |
| 1) <table border="1" style="width: 100%; border-collapse: collapse;"> <tr><td>2.0 dCi (110 kW) </td><td>→ 1.12</td></tr> <tr><td>2.0 (104 kW) </td><td>→ 1.12</td></tr> <tr><td>2.0 dCi (127 kW) </td><td>→ 1.12</td></tr> <tr><td>2.0 (110 kW) </td><td>→ 1.12</td></tr> <tr><td>2.5 (124 kW) </td><td>→ 1.12</td></tr> <tr><td>2.0 (104 kW) </td><td>3.07 → 2.14</td></tr> <tr><td>2.0 (103 kW) , </td><td>6.08 → 12.13</td></tr> </table> | | | | | | | | | | 2.0 dCi (110 kW) | → 1.12 | 2.0 (104 kW) | → 1.12 | 2.0 dCi (127 kW) | → 1.12 | 2.0 (110 kW) | → 1.12 | 2.5 (124 kW) | → 1.12 | 2.0 (104 kW) | 3.07 → 2.14 | 2.0 (103 kW) , | 6.08 → 12.13 |
| 2.0 dCi (110 kW) | → 1.12 | | | | | | | | | | | | | | | | | | | | | | |
| 2.0 (104 kW) | → 1.12 | | | | | | | | | | | | | | | | | | | | | | |
| 2.0 dCi (127 kW) | → 1.12 | | | | | | | | | | | | | | | | | | | | | | |
| 2.0 (110 kW) | → 1.12 | | | | | | | | | | | | | | | | | | | | | | |
| 2.5 (124 kW) | → 1.12 | | | | | | | | | | | | | | | | | | | | | | |
| 2.0 (104 kW) | 3.07 → 2.14 | | | | | | | | | | | | | | | | | | | | | | |
| 2.0 (103 kW) , | 6.08 → 12.13 | | | | | | | | | | | | | | | | | | | | | | |



| MODEL FAHRZEUG MODELE | YEAR JAHR ANNEE | FRONT/VORNE/AVANT | | | | REAR/HINTEN/ARRIERE | | | |
|-----------------------------|-----------------------|-----------------------------|-----------------------------|--------------------------------|--|-----------------------------|-----------------------------|--------------------------------|--|
| | | PREMIUM Twin-tube Oil | EXCEL-G Twin-tube Gas | GAS-A-JUST Mono-tube Gas | | PREMIUM Twin-tube Oil | EXCEL-G Twin-tube Gas | GAS-A-JUST Mono-tube Gas | |

Nissan (J)

X-Trail (T31)

| | | | | | | | | |
|---------------------------------|---------------|--|--|--|--|--------|---------|--|
| 2.0 (103 kW) (T31) | 6.08 - 11.13 | | | | | 349078 | 5540008 | |
| 2.0 (104 kW) | 3.07 - 11.13 | | | | | | | |
| 2.5 (124 kW) | 6.07 - 11.13 | | | | | | | |
| 2.0 dCi (110 kW) | 6.07 - 6.10 | | | | | | | |
| 2.0 dCi (130 kW) | 10.09 - 11.13 | | | | | | | |
| 2.0 dCi (110 kW) (T31) | 7.10 - 11.13 | | | | | 349097 | | |
| 2.0 dCi (110 kW) (T31) | 6.07 - 11.13 | | | | | 349078 | 5540008 | |
| 2.0 dCi (110 kW, 127 kW) (T31) | 6.07 - 6.10 | | | | | 349078 | 5540008 | |
| 2.0 dCi (110 kW, 127 kW) (T31) | 7.10 - 11.13 | | | | | 349097 | | |
| 2.0 dCi (110 kW, 127 kW) (T31) | 7.10 - 11.13 | | | | | 349078 | 5540008 | |

X-Trail (T32)

| | | | | | | | | |
|----------------|--|--|------------------------|--|--|--------|--|--|
| (T32_) 12.13 - | | | 3340159 L 3340158 R | | | 349097 | | |
| | | | SM1042 ¹⁾ | | | | | |

1) (T32R, T32RR)

Nissan Commercial (J)

Clipper, Caball

| | | | | | | | | |
|------------------------------|-------------|--------|--|--|--------|--------|--------|--|
| Clipper (T 65 series) | 66 - 71 | 444060 | | | 444023 | 344102 | 553084 | |
| Clipper (660, 661) | 2.69 - 8.71 | 444060 | | | | | | |
| Clipper (T 662, 663) | 4.69 - 5.76 | 444060 | | | | | | |
| Caball (C240, C340) Exc. | 68 - 12.81 | 444060 | | | 444024 | | | |

Homer, Cabstar

| | | | | | | | | |
|-------------------------------|-------------|--------|--|--|--------|--|----------------------------------|--|
| (F 20, F 21 series) | 1.76 - 3.78 | | | | 444025 | | | |
| (F 20) Exc. Low flat floor | 4.78 - 8.2 | 444054 | | | 444025 | | | |
| Low flat floor (F 20) | 10.78 - 8.2 | 444054 | | | 444055 | | | |
| 2.0 (F 22) | 1.82 - 2.89 | 444054 | | | 444055 | | | |
| 2.0 Exc. Steel High Bed | 2.89 - 6.92 | 444054 | | | | | O.E. = 56210-T3000/-T6100/-T6210 | |
| | | | | | | | O.E. = 56210-22T00 | |



| MODEL FAHRZEUG MODELE | YEAR JAHR ANNEE | FRONT/VORNE/AVANT | | | | REAR/HINTEN/ARRIERE | | | | |
|------------------------------|-----------------------|-----------------------------|-----------------------------|--------------------------------|--|-----------------------------|----------------------------------|--------------------------------|--|--|
| | | PREMIUM Twin-tube Oil | EXCEL-G Twin-tube Gas | GAS-A-JUST Mono-tube Gas | | PREMIUM Twin-tube Oil | EXCEL-G Twin-tube Gas | GAS-A-JUST Mono-tube Gas | | |
| Nissan Commercial (J) | | | | | | | | | | |
| Homer, Cabstar | | | | | | | | | | |
| 2.0 Steel High Bed | (F 22) | 2.89 - 6.92 | 444054 | | | | 444055 | | | |
| | | | | | | | O.E. = 56210-T6210 | | | |
| 2.3 TD Diesel | (F 22) | 1.82 - 6.92 | 444054 | | | | 444055 | | | |
| Incl. Low flat A-Chassis | | | | | | | O.E. = 56210-T6100/-T6210 | | | |
| 2.3 TD Diesel | (F 22) | 1.82 - 6.92 | 444054 | | | | 444026 | | | |
| Exc. Low flat A-Chassis | | | | | | | O.E. = 56210-T6200/-T6202 | | | |
| 2.3 TD Diesel | (F 22) | 1.82 - 6.92 | 444054 | | | | 444055 | | | |
| Incl. Low flat A-Chassis | | | | | | | O.E. = 56210-T6210 | | | |
| 2.5 TD Diesel | (F 22) | 1.82 - 2.89 | 444054 | | | | 444055 | | | |
| Incl. H/D | | | | | | | O.E. = 56210-T3000/-T6100/-T6210 | | | |
| 2.5 TD Diesel | (F 22) | 2.89 - 6.92 | 444054 | | | | | | | |
| Exc. H/D | | | | | | | O.E. = 56210-22T00 | | | |
| 2.5 TD Diesel | (F 22) | 2.89 - 6.92 | 444054 | | | | 444055 | | | |
| ⊕ H/D | | | | | | | O.E. = 56210-T6210 | | | |
| 2.5 TD Diesel | (F 22) | 1.82 - 6.92 | 444054 | | | | 444026 | | | |
| Exc. H/D | | | | | | | O.E. = 56210-T6200/-T6202 | | | |
| 2.5 TD Diesel | (F 22) | 1.82 - 6.92 | 444054 | | | | 444055 | | | |
| ⊕ H/D | | | | | | | O.E. = 56210-T6210 | | | |
| 2.0 | (F 23) | 7.92 - | 444054 | | | | | | | |
| | | | | | | | O.E. = 56210-22T00 | | | |
| 2.5 Diesel | (F 23) | 7.92 - | 444054 | | | | | | | |
| Exc. Low flat | | | | | | | O.E. = 56210-22T00 | | | |
| 2.5 Diesel | (F 23) | 7.92 - | 444054 | | | | 444026 | | | |
| Low flat | | | | | | | O.E. = 56210-T6202 | | | |
| 2.5 TDCi (81 kW) | (F 24M) | 9.06 - | 444322 | | | | 443466 | | | |
| | | | | | | | | | | |
| 2.5 TDCi (96 kW) | (F 24M) | 9.06 - | 444322 | | | | 443467 | | | |
| | | | | | | | | | | |
| Interstar | | | | | | | | | | |
| | 9.02 - | | 344306 | | | | | 344307 | | |
| | | | | | | | | | | |
| | 9.02 - | | 344306 | | | | | 344307 | | |
| | | | | | | | | | | |



| MODEL FAHRZEUG MODELE | YEAR JAHR ANNEE | FRONT/VORNE/AVANT | | | | REAR/HINTEN/ARRIERE | | | |
|-----------------------------|-----------------------|-----------------------------|-----------------------------|--------------------------------|--|-----------------------------|-----------------------------|--------------------------------|--|
| | | PREMIUM Twin-tube Oil | EXCEL-G Twin-tube Gas | GAS-A-JUST Mono-tube Gas | | PREMIUM Twin-tube Oil | EXCEL-G Twin-tube Gas | GAS-A-JUST Mono-tube Gas | |

Nissan Commercial (J)

Kubistar

| | | | | | | | | | |
|-----------------|-------|--------|------------------|--|--|--|--|----------------------|--|
| 2x(0-0) Exc. | (X76) | 8.03 - | 633848 913237 | 333848 MB1504 SM1507▼ SM1018 | | | | 551810 ¹⁾ | |
| 4x(0-0) Exc. | (X76) | 8.03 - | 633848 913237 | 333848 MB1504 SM1507▼ SM1018 | | | | 551811 ²⁾ | |
| Exc. | (X76) | 8.03 - | | O.E. = 5430200QAD MB1504 SM1507▼ SM1018 | | | | 551811 ²⁾ | |

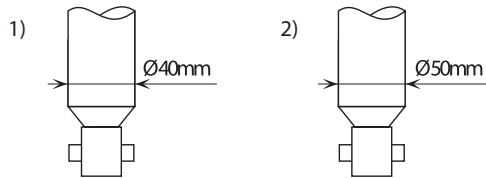

NV200 , NV200 Evalia

| | | | | | | | | | |
|---------------|--------|--|--|----------------------------------|--|--|--|--|--|
| Exc. e-NV | 2.10 - | | | 3330055 L 3330054 R MB1509 | | | | | |
|---------------|--------|--|--|----------------------------------|--|--|--|--|--|

NV300

| | | | | | | | | | |
|---------------|-------|--------|--|--------|--|--|--------|--|--|
| Incl. H/D | (X82) | 9.16 - | | 335803 | | | 344803 | | |
|---------------|-------|--------|--|--------|--|--|--------|--|--|

NV400

| | | | | | | | | | |
|-----------------|---------|--|--|------------------|--|--|--------|--|--|
| 2.3 dCi | 11.11 - | | | 335835 SM1019 | | | 345702 | | |
| 2.3 dCi | 11.11 - | | | 335835 SM1019 | | | 345703 | | |
| 2.3 dCi | 11.11 - | | | 335837 SM1019 | | | 345704 | | |

Primastar

| | | | | | | | | | |
|--|--------|--|--|----------------------------|--|--|--------|--|--|
| | 9.01 - | | | 335803 910039 SM1511 | | | 344803 | | |
|--|--------|--|--|----------------------------|--|--|--------|--|--|

Serena Cargo, Vanette Cargo

| | | | | | | | | | |
|---------------------|--------|--------|--------------------------------|--------------------------------|--|--------|--------|--------|--|
| 1.6, 2.0 Diesel | (C 23) | 7.92 - | 634075 L 634074 R 935308 | 334143 L 334142 R SM5153 | | 443149 | 343213 | 553116 | |
|---------------------|--------|--------|--------------------------------|--------------------------------|--|--------|--------|--------|--|



| MODEL FAHRZEUG MODELE | YEAR JAHR ANNEE | FRONT/VORNE/AVANT | | | | REAR/HINTEN/ARRIERE | | | |
|---|-----------------------|--------------------------------|--|--------------------------------|--|-----------------------------|-----------------------------|--------------------------------|--|
| | | PREMIUM Twin-tube Oil | EXCEL-G Twin-tube Gas | GAS-A-JUST Mono-tube Gas | | PREMIUM Twin-tube Oil | EXCEL-G Twin-tube Gas | GAS-A-JUST Mono-tube Gas | |
| Nissan Commercial (J) | | | | | | | | | |
| Serena Cargo, Vanette Cargo | | | | | | | | | |
| 2.3 Diesel (C 23) | 7.92 - | 634075 L 634074 R 935308 | 334143 L 334142 R | SM5153 | | 443149 | 343213 | 553116 | |
| Urvan, Caravan | | | | | | | | | |
| (E 20, 22, 23) | 4.78 - 10.86 | 444039 | | 554047 | | 443079 | | | |
| Exc. (E 24) | 11.86 - | 444132 | | | | 444025 | | | |
| Vanette, Vanette Cargo | | | | | | | | | |
| C120 () | 8.78 - 6.87 | 443187 | | 553099▼ | | 443184 | | 553100 | |
| C120, C220 () | | 443187 | | 553099▼ | | 443184 | | 553100 | |
| | | O.E. = 56110 -Y9502 | | | | | O.E. = 56210 -Y9502 | | |
| (C22) | 9.87 - 3.93 | 444118 | | | | 443177 | | 553145▼ | |
| (C22) | 9.86 - 3.93 | 444118 | | | | 443279 | | | |
| Opel (D) | | | | | | | | | |
| Adam, Adam Rocks | | | | | | | | | |
| 1.0, 1.2, 1.4 (M13) Incl. Sport sus., Exc. 1.4 LPG, 1.4 S, , Adam Rocks | 10.12 - 2.19 | | 339715 L 339714 R 910203 ¹⁾ | SM1820 | | | 3430061 910276 | SM9806 L SM9805 R | |
| 1.0, 1.2, 1.4 (M13) , Adam Rocks Exc. 1.4 LPG, 1.4 S, , Sport sus. | 10.12 - 2.19 | | 910134 ²⁾ | SM1820 | | | 3430061 910277 | SM9806 L SM9805 R | |
| 1.4 LPG, 1.4 S (M13) | 7.13 - 1.19 | | 910203 ¹⁾³⁾ | SM1820 | | | 910276 ³⁾ | SM9806 L SM9805 R | |
| 1) Bumper height : 40 mm 2) Bumper height : 65 mm 3) Exc. , Adam Rocks | | | | | | | | | |
| Agila | | | | | | | | | |
| (H00) 1.0, 1.2, 1.3 CDTI Incl. ABS | 4.00 - 8.07 | | 333307 L 333306 R 910108 | SM1035 | | | 343331 | | |
| 1.0, 1.0 LPG, 1.2, 1.2 LPG 1.3 CDTI (H08) | 9.07 - | | 333409 L 333408 R 912027▼ 912052 | SM1034 | | | 343420 | SM9930 | |



| MODEL FAHRZEUG MODELE | YEAR JAHR ANNEE | FRONT/VORNE/AVANT | | | | REAR/HINTEN/ARRIERE | | | |
|--|--|-----------------------------|-----------------------------|--------------------------------|--|-----------------------------|-----------------------------|--------------------------------|--|
| | | PREMIUM Twin-tube Oil | EXCEL-G Twin-tube Gas | GAS-A-JUST Mono-tube Gas | | PREMIUM Twin-tube Oil | EXCEL-G Twin-tube Gas | GAS-A-JUST Mono-tube Gas | |
| Opel (D) | | | | | | | | | |
| Ampera | | | | | | | | | |
| | 11.11 - | | | | | | | | |
| 1) → 7.12 → CU999999 | | 910222 ¹⁾ | | | | | | | |
| Antara A | | | | | | | | | |
| Exc. | (L07) 7.06 - | | 3350067 L 3350066 R | | | | 345084 | | |
| | | 910285 | | | | | | | |
| Ascona, Manta | | | | | | | | | |
| Ascona, L, SR, Voyage Manta, L, SR, GT Manta E Manta CC/CCE/GTE | 8.75 - 6.81 8.75 - 88 9.77 - 88 8.78 - 88 | 443026 | 343048 ▼ | | | 443027 | 343006 | | |
| | | 244029 | | | | | | 244030 ▼ | |
| Ascona | 8.81 - 8.84 | 665042 | 365030 ▼ | | | 443230 | 343150 ▼ | | |
| | | 910083 | | | | | | | |
| Ascona C 1003027 → 5000001 → 6000001 → | 9.84 - 9.88 | 665057 | | | | 443230 | 343150 ▼ | | |
| | | 910083 | | | | | | | |
| Astra Exc. OPC / | | | | | | | | | |
| Astra F Exc. GT, GSi | 9.91 - 1.98 | 665501 | 365504 375034 | | | 443134 | 343047 | 553075 ▼ 243014 | |
| | | 910160 ▼ | | | | | | | |
| Astra F GT, GSi | 9.91 - 1.98 | | 365504 375034 | | | | 343047 | 553075 ▼ 243014 | |
| | | 910160 ▼ | | | | | | | |
| Astra F | 9.91 - 1.98 | 665501 | 365504 | | | 443135 | 343099 | 553137 ▼ | |
| | | 910160 ▼ | | | | | | Exc. | |
| Astra G (F69, F48, F08, T98) Exc. Sport sus. | 98 - 3.04 | | 334847 L 334846 R | | | | 343306 | 553240 | |
| | | 935301 ¹⁾ | | | | | | | |
| Astra G (F69, F48, F08, T98) ⊕ Sport sus. | 98 - 3.04 | | | | | | 343306 | 553240 | |
| | | 935301 ¹⁾ | | | | | | | |
| Astra G (F35, T98) Exc. Sport sus. | 98 - 3.04 | | 334847 L 334846 R | | | | 343307 | 553241 ▼ | |
| | | 935301 ¹⁾ | | | | | | | |
| 1) Incl. OPC | | | | | | | | | |



| MODEL FAHRZEUG MODELE | YEAR JAHR ANNEE | FRONT/VORNE/AVANT | | | | REAR/HINTEN/ARRIERE | | | |
|---|-----------------------|-----------------------------|---|--------------------------------|--|-----------------------------|-----------------------------|--------------------------------|--|
| | | PREMIUM Twin-tube Oil | EXCEL-G Twin-tube Gas | GAS-A-JUST Mono-tube Gas | | PREMIUM Twin-tube Oil | EXCEL-G Twin-tube Gas | GAS-A-JUST Mono-tube Gas | |
| Opel (D) | | | | | | | | | |
| Astra Exc. OPC / | | | | | | | | | |
| Astra G ⊕ Sport sus. | (F35, T98) | 98 - 3.04 | | | | | 343307 | 553241 ▼ | |
| | | | ☹☹☹ 935301 ¹⁾ SM1313 ¹⁾ | | | | | | |
| Astra G 1.6, 1.8 16V, 2.0 16V 2.2 16V, 2.2 DTi Exc. Sport sus. | (F07, T98) | 9.00 - 5.05 | | 334847 L 334846 R | | | 343306 | 553240 | |
| | | | ☹☹☹ 935301 ¹⁾ SM1313 ¹⁾ | | | | | | |
| Astra G 1.6, 1.6 16V, 1.8 16V Exc. Sport sus. | (F67, T98) | 9.00 - 10.05 | | 334847 L 334846 R | | | 343306 | 553240 | |
| | | | ☹☹☹ 935301 ¹⁾ SM1313 ¹⁾ | | | | | | |
| Astra G 2.0 16V Turbo, 2.0 OPC 2.2 16V, 2.2 DTi ⊕ Sport sus. | (F67, T98) | 9.00 - 10.05 | | | | | 343306 | 553240 | |
| | | | ☹☹☹ 935301 ¹⁾ SM1313 ¹⁾ | | | | | | |
| 1) Incl. OPC | | | | | | | | | |
| Astra H, Astra H Classic Incl. Exc. 2.0 Turbo (177 kW) Exc. Sport sus., , IDS sus. | (A04) | 1.04 - | | 339703 L 339702 R | | | 344445 | | |
| | | | ☹☹☹ 910069 SM1310 | | | | | | |
| Astra H, Astra H Classic ⊕ Sport sus., Exc. 2.0 Turbo (177 kW), , IDS sus. | (A04) | 1.04 - | | 339703 L 339702 R | | | 344446 | | |
| | | | ☹☹☹ 910203 SM1310 | | | | | | |
| Astra H GTC Incl. Sport sus., , Exc. 2.0 Turbo (177 kW), IDS sus. | (A04) | 3.05 - 10.10 | | 339703 L 339702 R | | | 344446 | | |
| | | | ☹☹☹ 910069 ¹⁾ SM1310 ☹☹☹ 910203 ²⁾ | | | | | | |
| Astra H, Astra H GTC 2.0 Turbo (177 kW) Exc. IDS sus. | (A04) | 3.05 - 10.10 | | 339703 L 339702 R | | | | | |
| | | | ☹☹☹ 910069 SM1310 | | | | | | |
| Astra H, Astra H Classic Incl. Sport sus., , Exc. IDS sus. | (A04) | 2.07 - | | 339703 L 339702 R | | | | | |
| | | | ☹☹☹ 910069 ¹⁾ SM1310 ☹☹☹ 910203 ²⁾ | | | | | | |
| 1) Exc. Sport sus., 2) ⊕ Sport sus., | | | | | | | | | |



Opel

| MODEL FAHRZEUG MODELE | YEAR JAHR ANNEE | FRONT/VORNE/AVANT | | | | REAR/HINTEN/ARRIERE | | | |
|-----------------------------|-----------------------|-----------------------------|-----------------------------|--------------------------------|--|-----------------------------|-----------------------------|--------------------------------|--|
| | | PREMIUM Twin-tube Oil | EXCEL-G Twin-tube Gas | GAS-A-JUST Mono-tube Gas | | PREMIUM Twin-tube Oil | EXCEL-G Twin-tube Gas | GAS-A-JUST Mono-tube Gas | |

Opel (D)

Astra Exc. OPC /

| | | | | | | | | |
|--|---------------------------|--|----------------------|--|--|---------|--|--|
| Astra H, Astra H Classic ALL Incl. Exc. Sport sus., , IDS sus. | (A04) 2.04 - | | 339703 L 339702 R | | | | | |
| Astra H, Astra H Classic ALL ⊕ Sport sus., Exc. , IDS sus. | (A04) 2.04 - | | 339703 L 339702 R | | | 344445 | | |
| Astra H TwinTop 1.4, 1.6, 1.6 Turbo, 1.8 Exc. Sport sus., , IDS sus. | (A04) 9.05 - 10.10 | | 339703 L 339702 R | | | | | |
| Astra J ALL Incl. Exc. 2.0 BiTurbo CDTi, Astra GTC J Exc. Sport sus., , FlexRide sus. (GM) | (68, 69, 35) 12.09 - 7.12 | | 339372 L 339371 R | | | 348032 | | |
| Astra J ALL ⊕ Sport sus., Exc. 1.4, 2.0 BiTurbo CDTi, Astra GTC J Exc. , FlexRide sus. (GM) | (68, 69, 35) 12.09 - 7.12 | | 339374 L 339373 R | | | 348032 | | |
| Astra J 2.0 CDTi (118 kW) → A3999999 → A8999999 → AG999999 ⊕ | (68, 35) 12.09 - | | 339372 L 339371 R | | | 348032 | | |
| Astra J 1.4, 1.6, 1.6 SIDI, 1.6 Turbo 1.7 CDTi (kW : 81, 92, 96) Exc. , Sport sus., Exc. FlexRide sus. (GM), Astra GTC J | (68, 69, 35) 8.12 - | | 339419 L 339418 R | | | 348032 | | |
| Astra GTC J 1.4, 1.6, 1.6 SIDI, 1.8 1.6 CDTi, 1.7 CDTi 2.0 CDTi, 2.0 BiTurbo CDTi Exc. FlexRide sus. (GM) | (08) 10.11 - | | | | | 3440048 | | |

| | | | | | | | | | | | | | | | | | | | | | | | | | | | | |
|---------|---|---------------|--------------|---|------|--|------------|---------------|----------|--|------------|---------|--|------------|-----|--|--|--|-----|--|--|--|--------------|-----|--|--|-----|------------------|
| 1) | <table border="1"> <tr> <td>Astra J</td> <td></td> <td>⊕</td> <td>Exc.</td> </tr> <tr> <td></td> <td> B3000001 →</td> <td rowspan="3">Standard sus.</td> <td>FlexRide</td> </tr> <tr> <td></td> <td> B8000001 →</td> <td>BiTurbo</td> </tr> <tr> <td></td> <td> BG000001 →</td> <td>OPC</td> </tr> <tr> <td></td> <td></td> <td></td> <td>VXR</td> </tr> <tr> <td></td> <td></td> <td></td> <td>2.0 (206 kW)</td> </tr> <tr> <td>GTC </td> <td></td> <td></td> <td>GTC </td> </tr> </table> | Astra J | | ⊕ | Exc. | | B3000001 → | Standard sus. | FlexRide | | B8000001 → | BiTurbo | | BG000001 → | OPC | | | | VXR | | | | 2.0 (206 kW) | GTC | | | GTC | 2) ⊕ : ALL |
| Astra J | | ⊕ | Exc. | | | | | | | | | | | | | | | | | | | | | | | | | |
| | B3000001 → | Standard sus. | FlexRide | | | | | | | | | | | | | | | | | | | | | | | | | |
| | B8000001 → | | BiTurbo | | | | | | | | | | | | | | | | | | | | | | | | | |
| | BG000001 → | | OPC | | | | | | | | | | | | | | | | | | | | | | | | | |
| | | | VXR | | | | | | | | | | | | | | | | | | | | | | | | | |
| | | | 2.0 (206 kW) | | | | | | | | | | | | | | | | | | | | | | | | | |
| GTC | | | GTC | | | | | | | | | | | | | | | | | | | | | | | | | |
| | | | 3) : ⊖ | | | | | | | | | | | | | | | | | | | | | | | | | |



| MODEL FAHRZEUG MODELE | YEAR JAHR ANNEE | FRONT/VORNE/AVANT | | | | REAR/HINTEN/ARRIERE | | | |
|---|-----------------------|-----------------------------|-----------------------------|--------------------------------|--|-----------------------------|-----------------------------|--------------------------------|--|
| | | PREMIUM Twin-tube Oil | EXCEL-G Twin-tube Gas | GAS-A-JUST Mono-tube Gas | | PREMIUM Twin-tube Oil | EXCEL-G Twin-tube Gas | GAS-A-JUST Mono-tube Gas | |
| Opel (D) | | | | | | | | | |
| Astra | | | | | | | | | |
| Exc. OPC / | | | | | | | | | |
| Astra K (B16) 1.0 Turbo, 1.4, 1.4 Turbo (92 kW, 110 kW) 1.6 Biturbo, 1.6 Turbo 1.6 CDTi Incl. Removable tow bar Exc. | 6.15 - | | | | | | 3440091 | | |
| | | | | SM5888 ¹⁾ | | | SM5887 ¹⁾ | | |
| 1) Incl. | | | | | | | | | |
| Calibra | | | | | | | | | |
| 2.0 i (2WD) (4WD) Exc. 16 V, 16 V Turbo | 90 - 98 | 665063 | 365503 375032 | | | | 343259 353011▼ | | |
| | | 910083 | SM1301 | | | | | | |
| 2.0 i 16V (2WD) (4WD) 2.5 i V6 (2WD) | 90 - 98 | | 365503 375032 | | | | 343259 353011▼ | | |
| | | 910083 | SM1301 | | | | | | |
| 2.0 i 16V Turbo (4WD) | 90 - 98 | | 365503 375032 | | | | 343259 353011▼ | | |
| | | 910083 | SM1301 | | | | | | |
| Cascada | | | | | | | | | |
| (W13) | 3.13 - | | | | | | | | |
| | | 910222 ¹⁾ | SM1008 | | | | SM9908 | | |
| 1) Exc. | | | | | | | | | |
| Commodore | | | | | | | | | |
| Commodore A 2.2, 2.5, Taxi | 67 - 1.72 | 443029 | 343005 | | | 443030 | | | |
| Commodore B 2.5, 2.8 | 9.72 - 7.77 | 443029 | 343005 | | | 443027 | 343006 | | |
| Commodore B 2.5, 2.8 | 9.72 - 4.75 | 443029 | 343005 | | | 443031 | | | |
| Commodore C 2.5 S, 2.5 E | 78 - 82 | 665035 | | | | 443027 | 343006 | | |
| | | 915322▼ 910083 | | | | | | | |
| Corsa A, Corsa B | | | | | | | | | |
| Exc. 1.6 GSi | 83 - 2.93 | 633831 | 333831 323034 | | | 443225 | 343265 353012 | 553155▼ | |
| | | 910083 | SM1305 | | | | | | |
| 1.6 GSi | 88 - 2.93 | | 333831 323034 | | | | 343265 353012 | 553155▼ | |
| | | 910083 | SM1305 | | | | | | |



| MODEL FAHRZEUG MODELE | YEAR JAHR ANNEE | FRONT/VORNE/AVANT | | | | REAR/HINTEN/ARRIERE | | | |
|--|-----------------------|--|-----------------------------|--------------------------------|--|--|-----------------------------|--------------------------------|--|
| | | PREMIUM Twin-tube Oil | EXCEL-G Twin-tube Gas | GAS-A-JUST Mono-tube Gas | | PREMIUM Twin-tube Oil | EXCEL-G Twin-tube Gas | GAS-A-JUST Mono-tube Gas | |
| Opel (D) | | | | | | | | | |
| Corsa A, Corsa B | | | | | | | | | |
| ALL Exc. Sport, GSi | 3.93 - 9.00 | 633831 | 333831 <u>323034</u> | | | 443225 | 343265 <u>353012</u> | 553155▼ | |
| | | 910083 | SM2302 | | | | | | |
| 1.4 i Sport, 1.4 Si Sport, 1.5 TD Sport 1.6 i 16V GSi | 3.93 - 9.00 | | 333831 <u>323034</u> | | | | 343265 <u>353012</u> | 553155▼ | |
| | | 910083 | SM2302 | | | | | | |
| Corsa C | | | | | | | | | |
| 1.0, 1.2, 1.3 CDTi, 1.7 Di Exc. , Sport sus. | 9.00 - | | 333756 L 333755 R | | | | 343350 | | |
| | | 935303 | SM1313 | | | | | | |
| 1.4, 1.8, 1.7 CDTi, 1.7 DTi Exc. , Sport sus. | 9.00 - | | 333756 L 333755 R | | | | 343351 | | |
| | | 935303 | SM1313 | | | | | | |
| Corsa D | | | | | | | | | |
| 1.0, 1.2, 1.4 1.2 LPG Exc. Sport sus. | 7.06 - | | 339715 L 339714 R | | | | 343459 | | |
| | | 910134 ¹⁾ 910203 ²⁾ | SM1820 | | | 913121 | SM9806 L SM9805 R | | |
| 1.3 CDTi (55 kW, 66 kW), 1.7 CDTi Exc. Sport sus. | 7.06 - | | 339717 L 339716 R | | | | 343459 | | |
| | | 910134 ¹⁾ 910203 ²⁾ | SM1820 | | | 913121 | SM9806 L SM9805 R | | |
| 1.6 Turbo | 2.07 - | | 339715 L 339714 R | | | | | | |
| | | 910134 ¹⁾ 910203 ²⁾ | SM1820 | | | 913121 | SM9806 L SM9805 R | | |
| 1) Exc. 2) | | | | | | | | | |
| Corsa E | | | | | | | | | |
| ALL (X15) Exc. 1.6 Turbo, Sport sus., , | 9.14 - | | 339715 L 339714 R | | | | 343459 | | |
| | | 910134 ¹⁾ | SM1820 | | | 910277 ¹⁾ | SM9806 L SM9805 R | | |
| Sport sus., , (X15) Exc. 1.6 Turbo | 9.14 - | | 339715 L 339714 R | | | | 3430078 | | |
| | | 910134 ¹⁾ | SM1820 | | | 910277 ¹⁾ 910276 ²⁾ | SM9806 L SM9805 R | | |
| 1.6 Turbo Incl. Sport sus. (X15) | 3.15 - | | 3348081 L 3348080 R | | | | | | |
| | | 910203 | SM1820 | | | | SM9806 L SM9805 R | | |
| 1) normal sus. 2) sport sus. | | | | | | | | | |



| MODEL FAHRZEUG MODELE | YEAR JAHR ANNEE | FRONT/VORNE/AVANT | | | | REAR/HINTEN/ARRIERE | | | | | | | | | | | | |
|---|-----------------------|-----------------------------|-----------------------------|--------------------------------|--|-----------------------------|-----------------------------|--|--|------------|--|------|--------|-------------|---------|--------|------------|---------|
| | | PREMIUM Twin-tube Oil | EXCEL-G Twin-tube Gas | GAS-A-JUST Mono-tube Gas | | PREMIUM Twin-tube Oil | EXCEL-G Twin-tube Gas | GAS-A-JUST Mono-tube Gas | | | | | | | | | | |
| Opel (D) | | | | | | | | | | | | | | | | | | |
| Crossland X / Crossland | | | | | | | | | | | | | | | | | | |
| (P17, P2QO) | 3.17 - | | 3338052 L 3338051 R | | | | 3438001 | | | | | | | | | | | |
| Frontera | | | | | | | | | | | | | | | | | | |
| (52SU, 53MW, 5JMW) Incl. Sport | 10.91 - 9.95 | 444120 | 344227 | | | 444122 | 344228 | | | | | | | | | | | |
| (54/55/5B/5K SU, 54/55/5B/5K MW) Incl. Sport | 9.95 - 10.98 | | 344227 | | | | 344229 | | | | | | | | | | | |
| Incl. Sport | 10.98 - | | 344298 | | | | 344299 | | | | | | | | | | | |
| Grandland X | | | | | | | | | | | | | | | | | | |
| 1.2, 1.5, 1.6 Turbo (110 kW, 133 kW) (A18) 1.5 Turbo D, 1.6 Turbo D (88 kW) 2.0 CDTi, 2.0 D Exc. Hybrid | 6.17 - | | 3348091 | | | | 3448001 | | | | | | | | | | | |
| (A18) 1.6 Turbo Hybrid | 6.19 - | | 3348091 | | | | | | | | | | | | | | | |
| Insignia A | | | | | | | | | | | | | | | | | | |
| 1.4, 1.6, 1.8, 1.6 T, 2.0 T, 2.8 V6 T, 2.0 CDTi 2.0 Biturbo CDTi, 2.0 Turbo E85 Exc. OPC, Sri, Sport sus., Exc. Flexride sus. | 7.08 - 3.17 | | 339376 L 339375 R | | | | 349136 | | | | | | | | | | | |
| 1.4, 1.6, 1.8, 1.6 T, 2.0 T, 2.8 V6 T, 2.0 CDTi 2.0 Biturbo CDTi, 2.0 Turbo E85 Sri, Sport sus., Exc. OPC, Flexride sus. | 7.08 - 3.17 | | 339376 L 339375 R | | | | | | | | | | | | | | | |
| 1.4 LPG, 1.6 SIDI, 1.6 CDTi | 7.09 - 3.17 | | 910176 ¹⁾ | | | | | | | | | | | | | | | |
| 2.0 T, 2.8 V6 T 2.0 CDTi, 2.0 Biturbo CDTi Incl. Sri, Sport sus., Exc. OPC, Flexride sus. | 7.08 - 3.17 | | 339376 L 339375 R | | | 443134 | 343047 | 553075 ▼ 243014 | | | | | | | | | | |
| 2.8 V6 T OPC | 7.09 - 3.17 | | | | | 443134 | 343047 | 553075 ▼ 243014 SM5652 L SM5651 R | | | | | | | | | | |
| 1) Exc. ; Incl. 1.4 LPG, 1.6 SIDI, 2.0 BiTurbo CDTi | | | | | | | | | | | | | | | | | | |
| 2) <table border="1"> <tr> <td>KYB</td> <td></td> <td>Date</td> </tr> <tr> <td> SM5610</td> <td>→ D1999999</td> <td>→ 07.13</td> </tr> <tr> <td> SM1076</td> <td> E1000001 →</td> <td>08.13 →</td> </tr> </table> | | | | | | | | | | KYB | | Date | SM5610 | → D1999999 | → 07.13 | SM1076 | E1000001 → | 08.13 → |
| KYB | | Date | | | | | | | | | | | | | | | | |
| SM5610 | → D1999999 | → 07.13 | | | | | | | | | | | | | | | | |
| SM1076 | E1000001 → | 08.13 → | | | | | | | | | | | | | | | | |



| MODEL FAHRZEUG MODELE | YEAR JAHR ANNEE | FRONT/VORNE/AVANT | | | | REAR/HINTEN/ARRIERE | | | |
|---|-----------------------|-----------------------------|-----------------------------|--------------------------------|----------------------|-----------------------------|-----------------------------|--------------------------------|------------------------|
| | | PREMIUM Twin-tube Oil | EXCEL-G Twin-tube Gas | GAS-A-JUST Mono-tube Gas | | PREMIUM Twin-tube Oil | EXCEL-G Twin-tube Gas | GAS-A-JUST Mono-tube Gas | |
| Opel (D) | | | | | | | | | |
| Insignia A Sports Tourer | | | | | | | | | |
| (2WD) 1.4, 1.6, 1.8, 1.6 T, 2.0 T 2.0 CDTi, 2.0 Turbo E85 Incl. Sri, Sport sus., Exc. OPC, Flexride sus. | 7.08 - 3.17 | | 339376 L 339375 R | | | | | | |
| | | | 910176 ¹⁾ | | SM5610 ²⁾ | | | | SM5652 L ³⁾ |
| | | | | | SM1076 ²⁾ | | | | SM5651 R ³⁾ |
| (2WD) 1.4 LPG, 1.6 SIDI 1.6 CDTi, 2.0 Biturbo CDTi Exc. | 7.08 - 3.17 | | | | | | | | |
| | | | 910176 ¹⁾ | | | | | | SM5652 L ³⁾ |
| | | | | | | | | | SM5651 R ³⁾ |
| (4WD) 2.0 T, 2.8 V6 T 2.0 CDTi, 2.0 BiTurbo CDTi Incl. Sri, Sport sus., Exc. OPC, Flexride sus. | 7.08 - 3.17 | | 339376 L 339375 R | | | 443134 | 343047 | 553075 ▼ 243014 | |
| | | | 910176 ¹⁾ | | SM5610 ²⁾ | | | | SM5652 L ³⁾ |
| | | | | | SM1076 ²⁾ | | | | SM5651 R ³⁾ |
| (4WD) 2.8 V6 T OPC | 7.09 - 6.15 | | | | | 443134 | 343047 | 553075 ▼ 243014 | |
| | | | | | | | | | SM5652 L ³⁾ |
| | | | | | | | | | SM5651 R ³⁾ |
| 1) Exc. (4WD) ; Incl. 1.4 LPG, 1.6 SIDI, 2.0 BiTurbo CDTi (2WD) 2) Date | | | | | | | | | |
| SM5610 → D1999999 → 07.13 | | | | | | | | | |
| SM1076 E1000001 → 08.13 → | | | | | | | | | |
| 3) Exc. | | | | | | | | | |
| Insignia A Country Tourer | | | | | | | | | |
| (2WD) Exc. | 7.08 - 3.17 | | | | | | | | |
| | | | | | | | | | SM5652 L |
| | | | | | | | | | SM5651 R |
| (4WD) Exc. | 9.13 - 3.17 | | | | | 443134 | 343047 | 553075 ▼ 243014 | |
| | | | | | | | | | SM5652 L |
| | | | | | | | | | SM5651 R |
| Insignia B Grand Sport | | | | | | | | | |
| (2WD) (Z18) 1.5, 1.6 CDTi, 2.0 CDTi Incl. Exc. FlexRide sus. (GM) | 3.17 - | | | | | | 3440073 | | |
| Insignia B Country Tourer | | | | | | | | | |
| (2WD) (Z18) 1.5, 2.0 CDTi Incl. Exc. FlexRide sus. (GM) | 3.17 - | | | | | | 3440073 | | |
| Insignia B Sports Tourer | | | | | | | | | |
| (2WD) (Z18) 1.5, 1.6 CDTi, 2.0 CDTi Incl. Exc. FlexRide sus. (GM) | 3.17 - | | | | | | 3440073 | | |



| MODEL FAHRZEUG MODELE | YEAR JAHR ANNEE | FRONT/VORNE/AVANT | | | | REAR/HINTEN/ARRIERE | | | | | | | | | |
|--|-----------------------|-----------------------------|-----------------------------|--------------------------------|--|-----------------------------|-----------------------------|--------------------------------|--|-------|-----|-----------------------|--|---|--|
| | | PREMIUM Twin-tube Oil | EXCEL-G Twin-tube Gas | GAS-A-JUST Mono-tube Gas | | PREMIUM Twin-tube Oil | EXCEL-G Twin-tube Gas | GAS-A-JUST Mono-tube Gas | | | | | | | |
| Opel (D) | | | | | | | | | | | | | | | |
| Kadett, Olympia, Aero | | | | | | | | | | | | | | | |
| Kadett B, Olympia A Exc. Kadett Rally | 68 - 73 | 443024 | | | | 443025 | | | | | | | | | |
| Kadett C, SR Aero | 73 - 79 76 - 79 | 443026 | 343048▼ | | | 443027 | 343006 | | | | | | | | |
| Kadett C, City (SR) Kadett 1.6 Itr. Caravan | 73 - 79 5.77 - 79 | 443026 | 343048▼ | | | 443025 | | | | | | | | | |
| Kadett D 1.2, 1.3, 1.3 S, SR | 79 - 8.84 | 665036 | 365501 375009 | | | 443134 | 343047 | 553075▼ 243014 | | | | | | | |
| Kadett D 1.0, 1.6 D, 1.6 S, 1.8 GT/E | 79 - 8.84 | | | | | | | | | | | | | | |
| Kadett D | 79 - 8.84 | 665036 | 365501 375009 | | | 443135 | 343099 | 553137▼ | | | | | | | |
| Kadett E | 9.84 - 91 | 665036 | 365501 375009 | | | 443134 | 343047 | 553075▼ 243014 | | | | | | | |
| Kadett E | 9.84 - 91 | 665036 | 365501 | | | 443135 | 343099 | 553137▼ | | | | | | | |
| Kadett E Combo | 9.85 - 93 | 665036 | 365501 | | | 443233 | 343227 | | | | | | | | |
| 1) <table border="1"> <thead> <tr> <th>Model</th> <th>KYB</th> </tr> </thead> <tbody> <tr> <td>1.2 / 1.3 / 1.4 / 1.6 </td> <td></td> </tr> <tr> <td>1.6 / 1.8 / 2.0 / 2.0 GSI / 2.0 GSI 16V / 2.0 GSI CAT / 2.0 GSI 16V CAT / Diesel</td> <td></td> </tr> </tbody> </table> | | | | | | | | | | Model | KYB | 1.2 / 1.3 / 1.4 / 1.6 | | 1.6 / 1.8 / 2.0 / 2.0 GSI / 2.0 GSI 16V / 2.0 GSI CAT / 2.0 GSI 16V CAT / Diesel | |
| Model | KYB | | | | | | | | | | | | | | |
| 1.2 / 1.3 / 1.4 / 1.6 | | | | | | | | | | | | | | | |
| 1.6 / 1.8 / 2.0 / 2.0 GSI / 2.0 GSI 16V / 2.0 GSI CAT / 2.0 GSI 16V CAT / Diesel | | | | | | | | | | | | | | | |
| Karl | | | | | | | | | | | | | | | |
| Incl. IDS sus. Exc. Rocks | (C16) | 1.15 - 3.19 | | | | | 3430069 | | | | | | | | |
| | | | | | | | | | | | | | | | |
| Meriva A | | | | | | | | | | | | | | | |
| Exc. Turbo | (X03) | 5.03 - 5.10 | 333756 L 333755 R | | | | 343308 | 553242 | | | | | | | |
| | | | | | | | | | | | | | | | |



| MODEL FAHRZEUG MODELE | YEAR JAHR ANNEE | FRONT/VORNE/AVANT | | | | REAR/HINTEN/ARRIERE | | | |
|--|-----------------------|-----------------------------|--|--------------------------------|--|-----------------------------|--|--------------------------------|--|
| | | PREMIUM Twin-tube Oil | EXCEL-G Twin-tube Gas | GAS-A-JUST Mono-tube Gas | | PREMIUM Twin-tube Oil | EXCEL-G Twin-tube Gas | GAS-A-JUST Mono-tube Gas | |
| Opel (D) | | | | | | | | | |
| Meriva A | | | | | | | | | |
| 1.6 Turbo | (X03) | 9.05 - 5.10 | | | | | | | |
| | | | 935303 | SM1313 | | | | | |
| Meriva B | | | | | | | | | |
| Incl. Hill-Start Assistant | (S10) | 6.10 - | | 339827 L 339826 R | | | 344715 | | |
| | | | 910203 ¹⁾ 910069 ²⁾ | SM1036 | | | | | |
| 1) Exc. 2) | | | | | | | | | |
| Mokka / Mokka X | | | | | | | | | |
| | (J13) | 6.12 - | | 3340214 L 3340213 R | | | 3440008 ▼ 3440035 | | |
| | | | | SM1008 | | | 912049 ¹⁾ 912048 ²⁾ | | |
| 1) : 6.12 → 2) : →12.16 : 1.17 → | | | | | | | | | |
| Monterey | | | | | | | | | |
| | (UBS) | 92 - 3.95 | | 344279 | | | 344229 | | |
| | (UBS) | 4.95 - 3.98 | | 344279 | | | 344229 | | |
| Omega A, Omega B | | | | | | | | | |
| Omega A 1.8, 2.0, 2.4 i, 2.3 D, 2.3 TD Exc. | | 9.86 - 4.94 | 634022 L 634021 R | 334100 L ▼ 334099 R ▼ | | 443234 | 343216 | 553162 ▼ | |
| | | | 915329 | SM1304 | | | Exc. | | |
| Omega A 2.6 i, 3.0 i, 3.0 i 24V, 3000, 3000 24V Exc. | | 9.86 - 4.94 | | 334100 L ▼ 334099 R ▼ | | | 343216 | 553162 ▼ | |
| | | | 915329 | SM1304 | | | Exc. | | |
| Omega B Exc. | | 94 - 7.03 | | 334903 | | | 343216 | 553162 ▼ | |
| | | | 915329 | SM1304 | | | Exc. | | |
| Omega A Caravan, Omega B Caravan | | | | | | | | | |
| Omega A Caravan 2.0, 2.3 D, 2.3 TD, 2.4 Exc. | | 9.86 - 4.94 | 634022 L 634021 R | 334100 L ▼ 334099 R ▼ | | | 344256 | 554088 ▼ | |
| | | | 915329 | SM1304 | | | Exc. | | |
| Omega A Caravan 2.6 i, 3.0 i, 3.0 i 24V Exc. | | 9.86 - 4.94 | | 334100 L ▼ 334099 R ▼ | | | 344256 | 554088 ▼ | |
| | | | 915329 | SM1304 | | | Exc. | | |
| Omega B Caravan Exc. | | 94 - 7.03 | | 334903 | | | 344256 | 554088 ▼ | |
| | | | 915329 | SM1304 | | | Exc. | | |



| MODEL FAHRZEUG MODELE | YEAR JAHR ANNEE | FRONT/VORNE/AVANT | | | | REAR/HINTEN/ARRIERE | | | |
|---|--------------------------|---|---|--------------------------------|--|-----------------------------|-----------------------------|--------------------------------|--|
| | | PREMIUM Twin-tube Oil | EXCEL-G Twin-tube Gas | GAS-A-JUST Mono-tube Gas | | PREMIUM Twin-tube Oil | EXCEL-G Twin-tube Gas | GAS-A-JUST Mono-tube Gas | |
| Opel (D) | | | | | | | | | |
| Rekord | | | | | | | | | |
| Rekord A, B, C | 63 - 1.72 | 443029 | 343005 | | | 443030 | | | |
| Rekord D 1.7, 1.9, 2.0, Sprint Rekord D 2.1 Diesel | 72 - 7.77 5.72 - 8.78 | 443029 | 343005 | | | 443027 | 343006 | | |
| Rekord E 1.7, 1.8, 1.9, 2.0, 2.2 | 8.77 - 9.86 | 665035 ☺☺☺☺ 915322 ▼ ☺☺☺☺ 910083 | | | | 443027 | 343006 | | |
| Rekord E 2.0 D, 2.3 D, 2.3 TD | 77 - 9.86 | 665056 ☺☺☺☺ 915322 ▼ ☺☺☺☺ 910083 | | | | 443027 | 343006 | | |
| Rekord Caravan | | | | | | | | | |
| Rekord A, B | 63 - 68 | 443029 | 343005 | | | | | | |
| Rekord C | 67 - 1.72 | 443029 | 343005 | | | 443030 | | | |
| Rekord D 1.7, 1.9, 2.0, 2.1 D | 1.72 - 7.77 | 443029 | 343005 | | | 443031 | | | |
| Rekord E 1.7, 1.8, 1.9, 2.0, 2.2, 2.3, 2.3 D | 8.77 - 9.86 | 665035 ☺☺☺☺ 915322 ▼ ☺☺☺☺ 910083 | | | | 443031 | | | |
| Senator , Monza (Exc.) | | | | | | | | | |
| Monza A Senator A | 5.78 - 8.87 | 665056 ☺☺☺☺ 915322 ▼ ☺☺☺☺ 910083 | | | | | 343044 Exc. | | |
| Senator B 2.3 TD, 2.5, 2.6 | 9.87 - 95 | 634022 L 634021 R ☺☺☺☺ 915329 SM1304 | 334100 L ▼ 334099 R ▼ | | | 443234 | 343216 Exc. | 553162 ▼ | |
| Senator B 3.0 i, 3.0 i 24V | 9.87 - 95 | | 334100 L ▼ 334099 R ▼ ☺☺☺☺ 915329 SM1304 | | | | 343216 Exc. | 553162 ▼ | |
| Signum | | | | | | | | | |
| 1.8, 2.0 Turbo, 2.2, 2.8, 2.8 V6 Turbo 3.2 V6, 1.9 CDTI, 2.0 DTI, 2.2 DTI 3.0 V6 CDTI Exc. Sport sus., | 4.02 - 5.08 | | 334633 L ¹⁾ ▼ 334632 R ¹⁾ ▼ 3348050 L ¹⁾ 3348049 R ¹⁾ 334635 L ²⁾ 334634 R ²⁾ ☺☺☺☺ 910069 SM1311 | | | | | 553307 | |
| 1) → 48999999 2) 51000001 → | | | | | | | | | |



| MODEL FAHRZEUG MODELE | YEAR JAHR ANNEE | FRONT/VORNE/AVANT | | | | REAR/HINTEN/ARRIERE | | | |
|---|-----------------------|-----------------------------|-----------------------------|--|--|-----------------------------|-----------------------------|--------------------------------|--|
| | | PREMIUM Twin-tube Oil | EXCEL-G Twin-tube Gas | GAS-A-JUST Mono-tube Gas | | PREMIUM Twin-tube Oil | EXCEL-G Twin-tube Gas | GAS-A-JUST Mono-tube Gas | |
| Opel (D) | | | | | | | | | |
| Sintra | | | | | | | | | |
| 2.2i, 2.2 DTi, 3.0i V6 Exc. | 3.96 - 12.99 | | 334227 | | | | 344338 | | |
| | | | | SM5143 | | | | | |
| Tigra | | | | | | | | | |
| | 94 - 1.01 | | 333831 | | | | 343265 | 553155▼ | |
| | | | 323034 | | | | 353012 | | |
| | | | | 910083 SM2302 | | | | | |
| Tigra Twintop | | | | | | | | | |
| | 7.04 - | | 333756 L 333755 R | | | | | | |
| | | | | SM1313 | | | | | |
| Vectra A | | | | | | | | | |
| 1.4, 1.6 i, 1.8 S, 1.8 i, 2.0 i 1.7 D, 1.7 TD Exc. 2.0 16V | 9.88 - 95 | 665063 | 365503 | | | 443134 | 343047 | 553075▼ | |
| | | | 375032 | | | | | 243014 | |
| | | | | 910083 SM1301 ¹⁾ SM1306 ²⁾ ▼ | | | Exc. | | |
| 2000-16V (= 20XE, C 20XE) → NV199999, → N1999999 → N5999999 | 9.88 - 92 | 665063 | 365503 | | | 443234 | 343216 | 553162▼ | |
| | | | | 910083 SM1301 ¹⁾ SM1306 ²⁾ ▼ | | | Exc. | | |
| 2000-16V (= 20XE, C 20XE) P1000001 →, P5000001 → P7000001 → | 93 - 95 | 665063 | 365503 | | | 443134 | 343047 | 553075▼ | |
| | | | 375032 | | | | | 243014 | |
| | | | | 910083 SM1301 ¹⁾ SM1306 ²⁾ ▼ | | | Exc. | | |
| 2.5 i V6 | 93 - 95 | | 365503 | | | | 343047 | 553075▼ | |
| | | | 375032 | | | | | 243014 | |
| | | | | 910083 SM1301 ¹⁾ SM1306 ²⁾ ▼ | | | Exc. | | |
| 1.8 i, 2.0 i, 2.0 i 16V, 2000 16V 2.0 i 16V Turbo | 9.88 - 95 | 665063 | 365503 | | | 443234 | 343216 | 553162▼ | |
| | | | | 910083 SM1301 ¹⁾ SM1306 ²⁾ ▼ | | | Exc. | | |
| 1) SM1301: Exc. GT 2) SM1306: GT | | | | | | | | | |
| Vectra B | | | | | | | | | |
| 1.6 i, 1.8 i, 1.7 TD, 2.0 i, 2.0 Di, 2.0 DTi, 2.2 i, 2.2 DTi Incl. 16V Exc. Sport sus. | 9.95 - 3.02 | | 333716 L 333715 R | | | | 341841 | | |
| | | | | 935301 SM1313 | | | 935302 | | |
| | | | | | | | Exc. | | |
| 2.5 i V6, 2.6 i V6 Exc. Sport sus. | 9.95 - 3.02 | | 333610 L 333609 R | | | | 341841 | | |
| | | | | 935301 SM1313 | | | 935302 | | |
| | | | | | | | Exc. | | |



| MODEL FAHRZEUG MODELE | YEAR JAHR ANNEE | FRONT/VORNE/AVANT | | | | REAR/HINTEN/ARRIERE | | | |
|--|-------------------------------------|-----------------------------|--|--------------------------------|--|-----------------------------|-----------------------------|--------------------------------|--|
| | | PREMIUM Twin-tube Oil | EXCEL-G Twin-tube Gas | GAS-A-JUST Mono-tube Gas | | PREMIUM Twin-tube Oil | EXCEL-G Twin-tube Gas | GAS-A-JUST Mono-tube Gas | |
| Opel (D) | | | | | | | | | |
| Vectra B | | | | | | | | | |
| ⊕ Sport sus. Exc. i500 | 9.95 - 3.02 | | 334610 L 334609 R | | | | 341841 | | |
| | | 935301 | SM1313 | | | 935302 | Exc. | | |
| Vectra C | | | | | | | | | |
| 1.6, 1.6 16V, 1.8, 1.8 16V, 2.0 16V Turbo, 2.2 Direct, 2.2 16V, 2.8 V6 Turbo, 3.2 V6, 1.9 CDTI (Incl. 16V), 2.0 DTI 16V, 2.2 DTI 16V, 3.0 CDTI, 3.0 V6 CDTI Exc. Sport sus., H/D, | 4.02 - | | 334633 L ¹⁾ ▼ 334632 R ¹⁾ ▼ 3348050 L ¹⁾ 3348049 R ¹⁾ 334635 L ²⁾ 334634 R ²⁾ | | | | | 553307 | |
| | | 910069 | SM1311 | | | | | | |
| 1.6, 1.6 16V, 1.8, 1.8 16V, 2.0 16V Turbo, 2.2 Direct, 2.2 16V, 2.8 V6 Turbo, 3.2 V6, 1.9 CDTI (Incl. 16V), 2.0 DTI 16V, 2.2 DTI 16V, 3.0 CDTI, 3.0 V6 CDTI ⊕ H/D | 4.02 - | | | | | | | | |
| | | 910071 | | | | | | | |
| 1) → 48999999 2) 51000001 → | | | | | | | | | |
| Zafira I | | | | | | | | | |
| Exc. 2.0 OPC, | (F75) 4.99 - 6.05 | | 334845 L 334844 R | | | | 343308 | 553242 | |
| | | 935301 | SM1313 | | | | | | |
| 2.0 OPC | (F75) 9.01 - 6.05 | | | | | | | | |
| | | 935301 | SM1313 | | | | | | |
| Zafira II | | | | | | | | | |
| 1.6, 1.6 CNG, 1.8 2.0 (147 kW, 177 kW), 2.2 1.7 CDTI, 1.9 CDTI Exc. , , Panoramic Roof, IDS | 7.05 - | | 339703 L 339702 R | | | | 349018 | | |
| | | 910069 ¹⁾ | SM1310 | | | 910203 ²⁾ | | | |
| 1) ⊕ 2) Exc. | | | | | | | | | |
| Zafira Tourer C | | | | | | | | | |
| 1.4, 1.6 CDTi, 1.6 SIDI, 1.8, 1.8 LPG (P12) 2.0 CDTi (kW : 81, 96, 118, 121) Incl. Exc. Sport sus., , FlexRide sus. (GM) | 10.11 - | | 339372 L 339371 R | | | | 349234 | | |
| | | 910222 | SM1008 | | | 910204 | SM9908 | | |
| 1.4, 1.8, 1.8 LPG, (P12) 2.0 CDTi (kW : 81, 96, 118, 121) ⊕ Sport sus., Exc. , FlexRide sus. (GM) | 10.11 - | | 339374 L 339373 R | | | | 3440048 | | |
| | | 910222 | SM1008 | | | 910204 | SM9908 | | |
| 1.4 LPG 1.6 CNG Exc. FlexRide sus. (GM) | (P12) 10.11 - 12.12 3.12 - 12.12 | | 339374 L 339373 R | | | | 349234 | | |
| | | 910222 | SM1008 | | | 910204 | SM9908 | | |



Opel

| MODEL FAHRZEUG MODELE | YEAR JAHR ANNEE | FRONT/VORNE/AVANT | | | | REAR/HINTEN/ARRIERE | | | |
|---|--|-----------------------------|-----------------------------|--------------------------------|--|-----------------------------|-----------------------------|--------------------------------|--|
| | | PREMIUM Twin-tube Oil | EXCEL-G Twin-tube Gas | GAS-A-JUST Mono-tube Gas | | PREMIUM Twin-tube Oil | EXCEL-G Twin-tube Gas | GAS-A-JUST Mono-tube Gas | |
| Opel (D) | | | | | | | | | |
| Zafira Tourer C | | | | | | | | | |
| 1.4 LPG, 1.6 CNG (P12) Exc. FlexRide sus. (GM) | 1.13 - | | 3340161 L 3340160 R | | | 349234 | | | |
| | | 910222 | SM1008 | | | 910204 | SM9908 | | |
| 2.0 CDTi (125 kW) (P12) 2.0 BiTurbo CDTi Exc. Sport sus., , FlexRide sus. (GM) | 1.13 - | | | | | 349234 | | | |
| | | 910222 | SM1008 | | | 910204 | SM9908 | | |
| 1.6 CDTi, 1.6 SIDI (P12) 2.0 CDTi (125 kW), 2.0 BiTurbo CDTi Sport sus., Exc. , FlexRide sus. (GM) | 1.13 - | | 3340161 L 3340160 R | | | 3440048 | | | |
| | | 910222 | SM1008 | | | 910204 | SM9908 | | |
| Opel Commercial (D) | | | | | | | | | |
| Blitz (Bedford CF) | | | | | | | | | |
| | 74 - | 445010 | | | | 445011 | | | |
| Campo/ Brava | | | | | | | | | |
| (TFR Series) | 92 - | 443190 | | 553119 | | 443295 | | 553230 | |
| | | | | | | | | | |
| (TFR Series) | 92 - | 443216 | | 553171 | | 443295 | | 553230 | |
| | | | | | | | | | |
| Combo | | | | | | | | | |
| | 10.93 - 10.01 | 633831 | 333831 | | | 443233 | 343227 | | |
| | | 910083 | SM2302 | | | | | | |
| Exc. | 10.01 - | | 333756 L 333755 R | | | | 343308 | 553242 | |
| | | 935303 | SM1313 | | | | | | |
| 1.4, 1.4 CNG (X12) 1.3 CDTi (55 kW) 1.3 CDTi (66 kW) 1.6 CDTi (kW : 66, 74, 77) 1.6 CDTi (70 kW, 88 kW) 2.0 CDTi | 2.12 - 4.15 - 2.12 - 2.12 - 4.15 - 2.12 - | | | | | | | | |
| | | | | SM1822 L SM1821 R | | | | | |
| Movano | | | | | | | | | |
| Exc. (U9), (H9) | 7.98 - 10 | | 344306 | | | | 344307 | | |
| | | | | | | | | | |
| Movano (B) | | | | | | | | | |
| 2.3 CDTi | (B) 5.10 - | | 335835 | | | | 345702 | | |
| | | 910278 ¹⁾ | SM1019 | | | | | | |
| 1) : : | | | | | | | | | |



| MODEL FAHRZEUG MODELE | YEAR JAHR ANNEE | FRONT/VORNE/AVANT | | | | REAR/HINTEN/ARRIERE | | | |
|-----------------------------|-----------------------|-----------------------------|-----------------------------|--------------------------------|--|-----------------------------|-----------------------------|--------------------------------|--|
| | | PREMIUM Twin-tube Oil | EXCEL-G Twin-tube Gas | GAS-A-JUST Mono-tube Gas | | PREMIUM Twin-tube Oil | EXCEL-G Twin-tube Gas | GAS-A-JUST Mono-tube Gas | |

Opel Commercial (D)

Movano (B)

| | | | | | | | | | |
|-----------------------|-----|--------|----------------------|--------|--|--|--------|--|--|
| 2.3 CDTI ⊕ = | (B) | 5.10 - | | 335835 | | | 345703 | | |
| | | | 910278 ¹⁾ | SM1019 | | | | | |
| 2.3 CDTI ⊕ = | (B) | 5.10 - | | 335837 | | | 345704 | | |
| | | | 910278 ¹⁾ | SM1019 | | | | | |

1) : ⊕
 : ⊕ ,

Vivaro

| | | | | | | | | | |
|----------------------|-------|--------|--------|--------|--|--|--------|--|--|
| | | 5.01 - | | 335803 | | | 344803 | | |
| | | | 910039 | SM1511 | | | | | |
| Incl. H/D, , | (X82) | 6.14 - | | 335803 | | | 344803 | | |
| | | | 910039 | SM1511 | | | | | |

Vivaro C / Zafira Life

| | | | | | | | | | |
|--|------|------|--|--|--|--|---------|--|--|
| | (K0) | 3.19 | | 3348085 ¹⁾ 3348084 ²⁾ | | | 3458001 | | |
|--|------|------|--|--|--|--|---------|--|--|

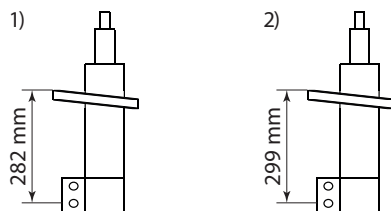

Peugeot (F)

104

| | | | | | | | | | |
|---|--|--|--------|--|--|--------|--|--|--|
| L, GL → 5534418 GL6 → 7070747 | | 73 - 8.76 74 - 8.76 | 664004 | | | | | | |
| | | | 913112 | | | | | | |
| GL 5534419 → 5675804 GL 6 7070748 → 7182579 SL → 7182579 | | 9.76 - 2.79 | 664004 | | | 441027 | | | |
| | | | 913112 | | | | | | |
| GL 5675805 → SL, GL 6 7182580 → S → 5852871 SR, GR = | | 3.79 - 88 3.79 - 88 9.78 - 80 3.79 - 88 | 664017 | | | 441027 | | | |
| | | | 913112 | | | | | | |
| S 5852872 → GL 6 Export 5675806 → 5852671 | | 80 - | | | | 441027 | | | |
| | | | 913112 | | | | | | |

104

| | | | | | | | | | |
|-------------------|--|-----------|--------|--|--|--|--|--|--|
| ZL, ZS 5534418 | | 9.73 - 77 | 664004 | | | | | | |
| | | | 913112 | | | | | | |



| MODEL FAHRZEUG MODELE | YEAR JAHR ANNEE | FRONT/VORNE/AVANT | | | | REAR/HINTEN/ARRIERE | | | |
|-----------------------------|-----------------------|-----------------------------|-----------------------------|--------------------------------|--|-----------------------------|-----------------------------|--------------------------------|--|
| | | PREMIUM Twin-tube Oil | EXCEL-G Twin-tube Gas | GAS-A-JUST Mono-tube Gas | | PREMIUM Twin-tube Oil | EXCEL-G Twin-tube Gas | GAS-A-JUST Mono-tube Gas | |

Peugeot (F)

104

| | | | | | | | | | |
|---|-----------|--------|--|--|--|--------|--|--|--|
| ZL 5534419 → 5684481 ZS 5534419 → 5684067 ZA 5534419 → 5684441 | 77 - 3.78 | 664004 | | | | 441041 | | | |
| | | 913112 | | | | | | | |
| ZL 5684482 → ZS 5684068 → ZA 5684442 → ZR, Z, ZS 2 = | 4.78 - 88 | 664017 | | | | 441041 | | | |
| | | 913112 | | | | | | | |

106 I, 106 II

| | | | | | | | | | |
|------------------|-----------------|--------|--|--|--|--------|--------|--------|--|
| Exc. 1.6 16V | 91 - 96 96 - | 665502 | 365506 375036 | | | 441065 | 341101 | 241006 | |
| | | 913112 | SM1902 ¹⁾ SM1903 ²⁾ | | | | | | |
| 1.6 16V | 94 - | | 365506 375036 | | | | 341101 | 241006 | |
| | | 913112 | SM1902 ¹⁾ SM1903 ²⁾ | | | | | | |

1) → 50265608 2) 50265609 →

107

| | | | | | | | | | |
|------------------|--------|--------|----------------------|--|--|--------|--------|--|--|
| 1.0 i 1.4 HDi | 6.05 - | | 332808 L 332807 R | | | | 343808 | | |
| | | 910123 | SM1930 | | | 912023 | SM9913 | | |

108

| | | | | | | | | | |
|-----------------------------|--------|--------|----------------------|--|--|--------|--------|--|--|
| Incl. Panorama Sunroof, | 5.14 - | | 332808 L 332807 R | | | | 343808 | | |
| | | 910123 | SM1930 | | | 912023 | SM9913 | | |

204, 304

| | | | | | | | | | |
|---------|-------------|--------|--|--|--|----------------------|--|--|--|
| 204 | 2.70 - 76 | 664006 | | | | 441028 ¹⁾ | | | |
| 304 | 2.70 - 9.72 | 664006 | | | | 441028 ¹⁾ | | | |
| 304 | 10.72 - 77 | 664006 | | | | | | | |

204, 304

| | | | | | | | | | |
|---------|-------------|--------|--|--|--|----------------------|--|--|--|
| 204 | 2.70 - 9.72 | 664006 | | | | 441028 ¹⁾ | | | |
|---------|-------------|--------|--|--|--|----------------------|--|--|--|

1) 441028

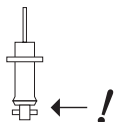



| MODEL FAHRZEUG MODELE | YEAR JAHR ANNEE | FRONT/VORNE/AVANT | | | | REAR/HINTEN/ARRIERE | | | |
|---|-----------------------|-----------------------------|--|--------------------------------|--|-----------------------------|-----------------------------|--------------------------------|--|
| | | PREMIUM Twin-tube Oil | EXCEL-G Twin-tube Gas | GAS-A-JUST Mono-tube Gas | | PREMIUM Twin-tube Oil | EXCEL-G Twin-tube Gas | GAS-A-JUST Mono-tube Gas | |
| Peugeot (F) | | | | | | | | | |
| 204, 304 | | | | | | | | | |
| 204 | 10.72- 76 | 664006 | | | | | | | |
| 304 | 70- 9.74 | 664006 | | | | | | | |
| 205 | | | | | | | | | |
| ALL , XA, XAD Exc. GTi, CTi, Rally, Turbo-Diesel | 83 - | 633828 | 333828 <u>324013 L</u> <u>324012 R</u> | | | 443220 | 343229 <u>354001</u> | 553138▼ | |
| Rally, Turbo Diesel, XDT | 83 - | | | | | 444091 | 344112 | | |
| 1.6 GTi, 1.9 GTi | 2.84 - | 634011 L 634010 R | 334023 L 334022 R <u>324013 L</u> <u>324012 R</u> | | | 444091 | 344112 <u>354001</u> | | |
| CT, CJ | 86- 94 | 633828 | 333828 <u>324013 L</u> <u>324012 R</u> | | | 443220 | 343229 <u>354001</u> | 553138▼ | |
| CTi | 86- 94 | 633830 | 333830▼ | | | 443220 | 343229 | 553138▼ | |
| 206 | | | | | | | | | |
| 1.1 i 1.4 HDi Exc. , XA, Entreprise | 9.98 - | 633730 L 633729 R | 333730 L 333729 R <u>323055 L</u> ▼ <u>323054 R</u> ▼ | | | 441110 | 341249 <u>351025</u> | | |
| 1.4 i, 1.4 LPG, 1.6 i, 1.9 D, 2.0 HDI 1.4 HDi 1.6 HDi 2.0 S16 Exc. , Entreprise | 9.98 - | 633730 L 633729 R | 333730 L 333729 R <u>323055 L</u> ▼ <u>323054 R</u> ▼ | | | 441110 | 341249 <u>351025</u> | | |



| Peugeot | MODEL FAHRZEUG MODELE | YEAR JAHR ANNEE | FRONT/VORNE/AVANT | | | | REAR/HINTEN/ARRIERE | | | |
|--|-----------------------------|-----------------------|-----------------------------|-----------------------------|--------------------------------|--------|-----------------------------|-----------------------------|--------------------------------|--|
| | | | PREMIUM Twin-tube Oil | EXCEL-G Twin-tube Gas | GAS-A-JUST Mono-tube Gas | | PREMIUM Twin-tube Oil | EXCEL-G Twin-tube Gas | GAS-A-JUST Mono-tube Gas | |
| Peugeot (F) | | | | | | | | | | |
| 206 | | | | | | | | | | |
| Entreprise 1.1 i XA, 1.4 i XA, 1.9 D, 1.4 HDi Exc. | 9.98 - | 633730 L 633729 R | 333730 L 333729 R | 323055 L ▼ 323054 R ▼ | | 441111 | 341250 | 351027 | | |
| 2.0 RC (2 A/C) | 7.03 - | | | | | | | | | |
| 206 CC | | | | | | | | | | |
| | 01 - | | 333730 L 333729 R | 323055 L ▼ 323054 R ▼ | | | 341250 | 351027 | | |
| | | | | 910041 | | | | | | |
| 206 SW | | | | | | | | | | |
| | 6.02 - | | 333730 L 333729 R | 323055 L ▼ 323054 R ▼ | | | 341250 | 351027 | | |
| | | | | 910041 | | | | | | |
| 206 + | | | | | | | | | | |
| 1.1, 1.4, 1.4 HDi | 1.09 - | 633730 L 633729 R | 333730 L 333729 R | 323055 L ▼ 323054 R ▼ | | 441110 | 341249 | 351025 | | |
| | | | | 910041 | | | | | | |
| | | | | | | | | | | |
| 1) | | Reference | Criteria | | | | | | | |
| | 1.1i / 1.4i | SM1910 L/SM1911 R | ⊕ H/D | | | | | | | |
| | 1.1i / 1.4i | SM1912 L/SM1913 R | Exc. H/D | | | | | | | |
| | 1.4 HDi | SM1910 L/SM1911 R | - | | | | | | | |



| MODEL FAHRZEUG MODELE | YEAR JAHR ANNEE | FRONT/VORNE/AVANT | | | | REAR/HINTEN/ARRIERE | | | |
|--|--|-----------------------------|--|--------------------------------|--|-----------------------------|-----------------------------|--------------------------------|--|
| | | PREMIUM Twin-tube Oil | EXCEL-G Twin-tube Gas | GAS-A-JUST Mono-tube Gas | | PREMIUM Twin-tube Oil | EXCEL-G Twin-tube Gas | GAS-A-JUST Mono-tube Gas | |
| Peugeot (F) | | | | | | | | | |
| 207 | | | | | | | | | |
| 1.4 (53 kW, 54 kW) (WA_, WC_) 1.4 16V (65 kW, 70 kW) Incl. Exc. | 2.06 - 4.08 | | 339710 L ¹⁾ 339709 R ¹⁾ | | | 349019 | | | |
| | | 910114 | MB1901 SM1932 | | | | | | |
| 1.4 HDi (50 kW) (WA_, WC_) 1.6 (81 kW), 1.6 16V (80 kW) 1.6 Flex, 1.6 HDi (66 kW) 1.6 HDi (68 kW, 80 kW), 1.6 HDi 110 1.6 16V VTi (88 kW) 1.6 16V VTi Exc. | 2.06 - 5.08 9.07 - 9.07 - 2.06 - 2.07 - 9.07 9.07 - | | 339708 L ²⁾ 339707 R ²⁾ | | | | | | |
| | | 910114 | MB1901 SM1932 | | | | | | |
| 1.4 HDi (50 kW) (WA_, WC_) 1.6 16V (80 kW), 1.6 Flex 1.6 HDi (66 kW), 1.6 16V VTi | 2.06 - 9.07 | | 339708 L ²⁾ 339707 R ²⁾ | | | | | | |
| | | 910114 | MB1901 SM1932 | | | | | | |
| 1.4 HDi (50 kW) (WA_, WC_) 1.6 16V (80 kW), 1.6 HDi (66 kW, 80 kW) 1.6 16V VTi (88 kW) | 2.06 - 5.08 2.06 - 9.07 2.06 - 9.07 | | | | | 349020 | | | |
| | | 910114 | MB1901 SM1932 | | | | | | |
| 1.6 16 V Turbo, 1.6 16V RC (WA_, WC_) | 2.06 - | | | | | | | | |
| | | 910114 | MB1901 SM1932 | | | | | | |
| 1) 2) Ø 47 mm Ø 51 mm | | | | | | | | | |
| 207 CC | | | | | | | | | |
| 1.6 16V (88 kW), 1.6 HDi (80 kW) | 2.07 - | | 339708 L ¹⁾²⁾ 339707 R ¹⁾²⁾ | | | 345076 | | | |
| | | 910114 | MB1901 SM1932 | | | | | | |
| 1.6 16V Turbo, 1.6 HDi (82 kW) | 2.07 - 3.14 | | | | | 345076 | | | |
| | | 910114 | MB1901 SM1932 | | | | | | |
| 1) 2) → 1.09 Ø 51 mm | | | | | | | | | |



| MODEL FAHRZEUG MODELE | YEAR JAHR ANNEE | FRONT/VORNE/AVANT | | | REAR/HINTEN/ARRIERE | | |
|-----------------------------|-----------------------|-----------------------------|-----------------------------|--------------------------------|-----------------------------|-----------------------------|--------------------------------|
| | | PREMIUM Twin-tube Oil | EXCEL-G Twin-tube Gas | GAS-A-JUST Mono-tube Gas | PREMIUM Twin-tube Oil | EXCEL-G Twin-tube Gas | GAS-A-JUST Mono-tube Gas |

Peugeot (F)

207 SW

| | | | | | | |
|----------------------------------|--------|--------|--|--|--------|--|
| 1.4, 1.4 16V | 6.07 - | | 339710 L ¹⁾³⁾ 339709 R ¹⁾³⁾ | | 345076 | |
| | | 910114 | MB1901 SM1932 | | | |
| 1.6 16V (88 kW), 1.6 HDi Exc. | 6.07 - | | 339708 L ²⁾⁴⁾ 339707 R ²⁾⁴⁾ | | 345076 | |
| | | 910114 | MB1901 SM1932 | | | |

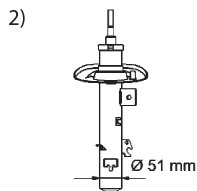
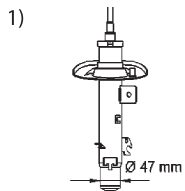

3) 1.4 16V (70 kW) : exc. , Trendy, Sport

4) 1.6 16V (88 kW) : exc. Trendy, Sport

208 I

| | | | | | | |
|--|--------|----------------------|--|--|--------|--|
| 1.0, 1.2 GPL, 1.2 PureTech 82 (CA_, CC_) 1.2 THP 110, 1.2 VTi 68 / PureTech 68 1.2 VTi 82, 1.4 GPL, 1.4 VTi 1.6 (kW : 88, 89, 115), 1.6 GTi, 1.6 THP 165 1.4 HDi, 1.5 BlueHDi 100, 1.6 HDi 1.6 HDi / BlueHDi 75, 1.6 BlueHDi 100 1.6 BlueHDi 120 | 3.12 - | | 3338013 L ¹⁾ 3338012 R ¹⁾ | | 349019 | |
| | | | 3338015 L ²⁾ 3338014 R ²⁾ | | | |
| | | | 3348013 L ³⁾ 3348012 R ³⁾ | | | |
| | | | 3338054 L ⁴⁾ 3338053 R ⁴⁾ | | | |
| | | 910259 ⁵⁾ | MB1901 | | | |
| | | 910260 ⁵⁾ | SM1553 | | | |
| | | 910261 ⁵⁾ | | | | |

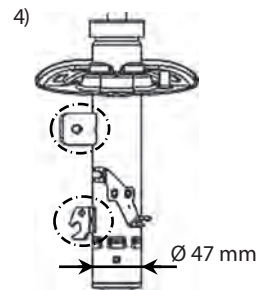
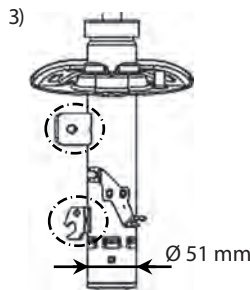
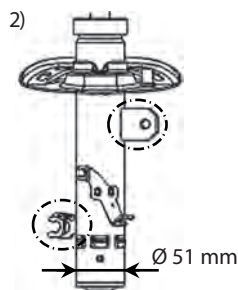
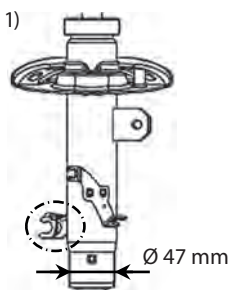

5)

| Suspension | Body style | | | | | | | | | |
|-------------|------------|--------|--------|--------|--------|--------|--------|---------|---------|--------|
| | | EC5 | DV | EB | EP | | | | | |
| | | | | | EP3C | EP6CDT | EP6FDT | EP6CDTX | EP6FDTX | |
| Normal sus. | | | | | 910260 | 910261 | 910260 | 910261 | 910259 | 910259 |
| | | 910260 | 910260 | 910261 | 910260 | 910261 | 910261 | Ø | Ø | |
| | box | | | | | | | | | |



| MODEL FAHRZEUG MODELE | YEAR JAHR ANNEE | FRONT/VORNE/AVANT | | | | REAR/HINTEN/ARRIERE | | | |
|--|----------------------------|-----------------------------|--|--------------------------------|--|-----------------------------|-----------------------------|--------------------------------|--|
| | | PREMIUM Twin-tube Oil | EXCEL-G Twin-tube Gas | GAS-A-JUST Mono-tube Gas | | PREMIUM Twin-tube Oil | EXCEL-G Twin-tube Gas | GAS-A-JUST Mono-tube Gas | |
| Peugeot (F) | | | | | | | | | |
| 301 | | | | | | | | | |
| Exc. 1.5 BlueHDi 100 | 11.12 - | | 3338001 L ¹⁾ 3338000 R ¹⁾ | | | 3438000 | | | |
| | | 910261 ²⁾ | SM1553 | | | | | | |
| 1.5 BlueHDi 100 | 5.18 - | | | | | 3438000 | | | |
| | | | SM1553 | | | | | | |
| 1) Ø 47 mm 2) → 1.13 | | | | | | | | | |
| 305 | | | | | | | | | |
| GL, GLS, GR, S, SR, GLD, GRD, SRD 8870213 → 8987000 | 82 - 6.82 | | | | | 441960 | | | |
| S, GL, GLS 8987001 → GR, SR 8987001 → 9524000 | 7.82 - 86 | 633829 | 333829 | | | 441960 | | | |
| | | 913112 | MB1901 SM1900 | | | | | | |
| S, GL, Automatic 9370001 → GR, SR 9524001 → | 86 - 88 | 633829 | 333829 | | | 441961 | | | |
| | | 913112 | MB1901 SM1900 | | | | | | |
| GLD, GRD, SRD 8987001 → | 7.82 - 88 | 633829 | 333829 | | | 441960 | | | |
| | | 913112 | MB1901 SM1900 | | | | | | |
| GT, GTX | 83 - 88 | 633829 | 333829 | | | 441961 | | | |
| | | 913112 | MB1901 SM1900 | | | | | | |
| 305 | | | | | | | | | |
| → 8987000 | 78 - 6.82 | | | | | 441962 | | | |
| 8987001 → | 7.82 - 89 | 633829 | 333829 | | | 441962 | | | |
| | | 913112 | MB1901 SM1900 | | | | | | |
| 306 | | | | | | | | | |
| 1.1 1.4 Exc. 175-70-, 175-65- | 93 - 2.97 | 633839 L 633838 R | 333839 L 333838 R | | | 441092 | 341166 | | |
| | | | 323839 L 323838 R | | | | | 241008 | |
| | | 913112 | MB1901 SM1907 ¹⁾ | | | H/D 441093 | | | |
| 1.4 175-70-, 175-65- 1.6, 1.8, 1.8 D, 1.9 D, 1.9 TD Exc. 2.0, 2.0 16V | 93 - 2.97 94 - 2.97 | 633839 L 633838 R | 333839 L 333838 R | | | 441093 | 341166 | | |
| | | | 323839 L 323838 R | | | | | 241008 | |
| | | 913112 | MB1901 SM1907 ¹⁾ | | | | | | |
| 1) | | | | | | | | | |



| MODEL FAHRZEUG MODELE | YEAR JAHR ANNEE | FRONT/VORNE/AVANT | | | | REAR/HINTEN/ARRIERE | | | |
|-----------------------------|-----------------------|-----------------------------|-----------------------------|--------------------------------|--|-----------------------------|-----------------------------|--------------------------------|--|
| | | PREMIUM Twin-tube Oil | EXCEL-G Twin-tube Gas | GAS-A-JUST Mono-tube Gas | | PREMIUM Twin-tube Oil | EXCEL-G Twin-tube Gas | GAS-A-JUST Mono-tube Gas | |

Peugeot (F)

306

| | | | | | | | | |
|--|-------------|----------------------|--|--|--------|--------|--------|--|
| 1.4 Exc. 175-70- | 3.97 - 01 | 633839 L 633838 R | 333839 L 333838 R 323839 L 323838 R | | 441092 | 341166 | 241008 | |
| 1.4 175-70-, 175-65- 1.6, 1.8, 1.8 D, 1.9 D, 1.9 TD Exc. 2.0, 2.0 16V | 4.93 - 5.01 | 633839 L 633838 R | 333839 L 333838 R 323839 L 323838 R | | 441093 | 341166 | 241008 | |
| 2.0, 2.0 16V, 2.0 HDi, 2.0 S16, 2.0 ST, 2.0 XSi | 4.93 - 5.01 | | 333839 L 333838 R 323839 L 323838 R | | 441093 | 341166 | 241008 | |
| | 3.94 - 4.02 | | 333839 L 333838 R 323839 L 323838 R | | 441093 | 341166 | 241008 | |
| | 6.94 - 4.02 | | 333839 L 333838 R 323839 L 323838 R | | 441093 | 341166 | 241008 | |
| | 7.93 - 7.01 | | 333839 L 333838 R 323839 L 323838 R | | 441093 | 341166 | 241008 | |

1)

307 , 307 SW , 307 CC

| | | | | | | | | |
|--------------|--------|--------|----------------------|--|--------|--|--|--|
| Exc. | 4.01 - | | 333758 L 333757 R | | | 344407 | | |
| | | 910067 | MB1901 SM1923 | | 910095 | SM9901 ¹⁾ SM9904 ²⁾ | | |

1) → 9.06

2) 9.06-11.07



| MODEL FAHRZEUG MODELE | YEAR JAHR ANNEE | FRONT/VORNE/AVANT | | | | REAR/HINTEN/ARRIERE | | | |
|--|--|--|-----------------------------|--------------------------------|--|-----------------------------|--|--------------------------------|--|
| | | PREMIUM Twin-tube Oil | EXCEL-G Twin-tube Gas | GAS-A-JUST Mono-tube Gas | | PREMIUM Twin-tube Oil | EXCEL-G Twin-tube Gas | GAS-A-JUST Mono-tube Gas | |
| Peugeot (F) | | | | | | | | | |
| 307 , 307 SW , 307 CC | | | | | | | | | |
| ALL | 4.01 - | | 338715 L 338714 R | | | 344408 | | | |
| | | 910067 | MB1901 SM1923 | | | 910095 | SM9901 ¹⁾ SM9904 ²⁾ | | |
| ALL Exc. | 4.01 - | | 333758 L 333757 R | | | 344408 | | | |
| | | 910067 | MB1901 SM1923 | | | 910095 | SM9901 ¹⁾ SM9904 ²⁾ | | |
| ALL | 4.01 - | | 338715 L 338714 R | | | 344408 | | | |
| | | 910067 | MB1901 SM1923 | | | 910095 | SM9901 ¹⁾ SM9904 ²⁾ | | |
| ALL Exc. | 10.03 - | | 333758 L 333757 R | | | 344408 | | | |
| | | 910067 | MB1901 SM1923 | | | 910095 | SM9901 ¹⁾ SM9904 ²⁾ | | |
| ALL | 10.03 - | | 338715 L 338714 R | | | 344408 | | | |
| | | 910067 | MB1901 SM1923 | | | 910095 | SM9901 ¹⁾ SM9904 ²⁾ | | |
| 1) → 9.06 2) 9.06-11.07 | | | | | | | | | |
| 308 I | | | | | | | | | |
| 1.4 VTi 16V 1.6 16V 1.6 HDi 2.0 16V 1.6 Gti 1.6 BioFlex Exc. , THP engines | 9.07 - 4.08 - 9.07 - 9.07 - 7.10 - 4.08 - | | 333769 L 333768 R | | | 349066 | | | |
| | | 910067 ¹⁾ 910198 ²⁾ | MB1901 SM1933 | | | 910095 | SM9902 | | |
| 2.0 HDi Exc. | 9.07 - | | 333771 L 333770 R | | | 345065 | | | |
| | | 910067 ¹⁾ 910198 ²⁾ | MB1901 SM1933 | | | 910095 | SM9902 | | |
| 308 SW I | | | | | | | | | |
| 1.4 16V 1.6 Bioflex 1.6 16V Incl. | 9.07 - 3.09 - 9.07 - | | 333769 L 333768 R | | | 344408 | | | |
| | | 910067 ¹⁾ 910198 ²⁾ | MB1901 SM1933 | | | 910095 | SM9902 | | |
| 1.4 16V 1.6 16V 1.6 HDi 2.0 Bioflex Exc. | 12.09 - 3.08 - 9.07 - 1.08 - | | 333769 L 333768 R | | | 344408 | | | |
| | | 910067 ¹⁾ 910198 ²⁾ | MB1901 SM1933 | | | 910095 | SM9902 | | |
| 1) OE p/n = 503370 2) OE p/n = 5033C8 Bumper height : 96 mm Bumper height : 87 mm | | | | | | | | | |



| MODEL FAHRZEUG MODELE | YEAR JAHR ANNEE | FRONT/VORNE/AVANT | | | | REAR/HINTEN/ARRIERE | | | |
|---|-----------------------|--|-----------------------------|--------------------------------|--|-----------------------------|-----------------------------|--------------------------------|--|
| | | PREMIUM Twin-tube Oil | EXCEL-G Twin-tube Gas | GAS-A-JUST Mono-tube Gas | | PREMIUM Twin-tube Oil | EXCEL-G Twin-tube Gas | GAS-A-JUST Mono-tube Gas | |
| Peugeot (F) | | | | | | | | | |
| 308 SW I | | | | | | | | | |
| 2.0 HDi Exc. | 9.07 - | | 333771 L 333770 R | | | 344408 | | | |
| | | 910067 ¹⁾ MB1901 910198 ²⁾ SM1933 | | | | 910095 SM9902 | | | |
| 1.6 HDi 2.0 16V | 9.07 - 1.08 - | | 333773 L 333772 R | | | 344408 | | | |
| | | 910067 ¹⁾ MB1901 910198 ²⁾ SM1933 | | | | 910095 SM9902 | | | |
| 1) OE p/n = 503370 Bumper height : 96 mm | | 2) OE p/n = 5033C8 Bumper height : 87 mm | | | | | | | |
| 308 CC | | | | | | | | | |
| Exc. | 4.09 - | | 333773 L 333772 R | | | 344407 | | | |
| | | 910067 ¹⁾ MB1901 910198 ²⁾ SM1933 | | | | 910095 SM9903▼ SM9901 | | | |
| 1) OE p/n = 503370 Bumper height : 96 mm | | 2) OE p/n = 5033C8 Bumper height : 87 mm | | | | | | | |
| 308 II , 308 SW II | | | | | | | | | |
| Incl. H/D Exc. GT, GTi, | 9.13 - | | 3348036 | | | 3448016 | | | |
| | | 910279 SM1055 | | | | | | | |
| Incl. GT Exc. GTi | 9.13 - | | | | | 3448016 | | | |
| | | 910279 SM1055 | | | | | | | |
| 2.0 GT Incl. H/D Exc. | 6.14 - | | 3348036 | | | | | | |
| | | 910279 SM1055 | | | | | | | |
| 309 | | | | | | | | | |
| Exc. GT, GT injection, Turbo Diesel, 1.9 SR | 85 - 93 | 633830 | 333830▼ | | | 443220 | 343229 | 553138▼ | |
| | | 913112 MB1901 SM1900 | | | | | | | |
| GT, GT injection, Turbo Diesel, 1.9 SR | 85 - 93 | 634011 L 634010 R | 334023 L 334022 R | | | 443220 | 343229 | 553138▼ | |
| | | | 324013 L 324012 R | | | | 354001 | | |
| | | 913112 MB1901 SM1900 | | | | | | | |
| 404 | | | | | | | | | |
| 5065744 → | 66 - 75 | 663046 | | | | 444077 | | | |
| | 67 - 76 | 663046 | | | | | | | |



| MODEL FAHRZEUG MODELE | YEAR JAHR ANNEE | FRONT/VORNE/AVANT | | | | REAR/HINTEN/ARRIERE | | | |
|---|-----------------------|-----------------------------|-----------------------------|--------------------------------|--|-----------------------------|--|--------------------------------|--|
| | | PREMIUM Twin-tube Oil | EXCEL-G Twin-tube Gas | GAS-A-JUST Mono-tube Gas | | PREMIUM Twin-tube Oil | EXCEL-G Twin-tube Gas | GAS-A-JUST Mono-tube Gas | |
| Peugeot (F) | | | | | | | | | |
| 404 | | | | | | | | | |
| U 8, U 10 | 66 - 76 | 663046 | | | | 445021 | | | |
| 405 | | | | | | | | | |
| Exc. MI 16, GRI, SRI, | 87 - 96 | 633829 | 333829 | | | 441066 | 341102 351014▼ | 551053▼ | |
| MI 16, GRI, SRI Exc. | 87 - 96 | | 333829 | | | 441066 | 341102 351014▼ | 551053▼ | |
| Exc. | 87 - 96 | 633829 | 333829 | | | | | OE = | |
| 1) → 11.99 2) 87-5.88 3) 5.88-6.92 4) 7.92 → | | | | | | | | | |
| 406 Exc. | | | | | | | | | |
| Exc. | 95 - 04 | 633728 L 633727 R | 333728 L 333727 R | | | 441102 ¹⁾ | 341229 ¹⁾ 341230 ²⁾ | | |
| Exc. | 95 - 04 | | | | | 441104 | 341231 | | |
| 1) 2) | | | | | | | | | |
| 407 407 SW | | | | | | | | | |
| 1.8 i, 2.0 i, 2.2 i, 1.6 HDi, 2.0 HDi, 2.2 HDi 2.0 Bioflex Exc. | 5.04 - | | 341825 | | | | 341826 | | |
| 2.7 HDi, 3.0 | 5.04 - | | | | | | | | |
| 407 | | | | | | | | | |
| 2.2 16V, 2.0 HDi | 10.05 - | | | | | | | | |
| 1) 2.0 HDi (100 kW, 120 kW), 2.2 16V, 2.7 HDi, 3.0 HDi, 3.0 V6 | | | | | | | | | |



| MODEL FAHRZEUG MODELE | YEAR JAHR ANNEE | FRONT/VORNE/AVANT | | | | REAR/HINTEN/ARRIERE | | | |
|-----------------------------|-----------------------|-----------------------------|-----------------------------|--------------------------------|--|-----------------------------|-----------------------------|--------------------------------|--|
| | | PREMIUM Twin-tube Oil | EXCEL-G Twin-tube Gas | GAS-A-JUST Mono-tube Gas | | PREMIUM Twin-tube Oil | EXCEL-G Twin-tube Gas | GAS-A-JUST Mono-tube Gas | |

Peugeot (F)

504

| | | | | | | | | | |
|--|-------------------------------|--|--|--|--|--------|--|--|--|
| GL, GLD, Ti → 2181356 | 68 - 76 | 664007 | | | | 444036 | | | |
| L, LD → 2181356 | 73 - 76 | 664007 | | | | 444037 | | | |
| GLD, Ti 2181357 → GL 2181357 → 3972015 | 76 - 80 76 - 85 | 664008 | | | | 444036 | | | |
| L, LD 2181357 → GR, SR, GRD → 3972015 SRD = | 76 - 80 80 - 85 80 - 83 | 664008 | | | | 444037 | | | |
| GL 3972016 → | 85 - | 664018 ¹⁾ 664008 ²⁾ | | | | 444036 | | | |
| GR, SR, GRD 3972016 → | 85 - | 664018 ¹⁾ 664008 ²⁾ | | | | 444037 | | | |

504

| | | | | | | | | | |
|---------------|---------|--------|--|--|--|--------|--|--|--|
| → 2085065 | 68 - 76 | 664007 | | | | 444036 | | | |
| 2085066 → | 76 - 83 | 664008 | | | | 444036 | | | |

504

| | | | | | | | | | |
|--|-------------------------------|--|--|--|--|--------|--|--|--|
| L, LD, GL, GLD → 2181356 | 72 - 76 | 664007 | | | | 441963 | | | |
| GL, GLD 2181357 → L, LD 2181357 → 3972015 GR, GRD 2181357 → 3972015 | 76 - 80 76 - 85 76 - 85 | 664008 | | | | 441963 | | | |
| L, LD, GR, GRD 3972016 → | 85 - | 664018 ¹⁾ 664008 ²⁾ | | | | 441963 | | | |

1) Exc. = SHORT



Lmax = 190 mm

2) = SHORT



Lmax = 180 mm

505

| | | | | | | | | | |
|---|--------------------|--|--|--|--|--------|--|--|--|
| GL, GR, SR, STi, Turbo-injection GLD, GRD, SRD, SRD Turbo → 1469621 | 79 - 83 | 664018 913113 ▼ 910085 | | | | 444036 | | | |
| GL, SL, GR, SR, Ti, STi, GTi, GLD, GRD SRD, SRD Turbo, GTD Turbo GRD Turbo 1469622 → 1845000 Turbo-injection 1469622 → 1887751 | 83 - 85 83 - 86 | 664018 ¹⁾ 664008 ²⁾ 913113 ▼ 910085 | | | | 444036 | | | |



| MODEL FAHRZEUG MODELE | YEAR JAHR ANNEE | FRONT/VORNE/AVANT | | | | REAR/HINTEN/ARRIERE | | | |
|--|-----------------------|--|-----------------------------|--------------------------------|--|---------------------------------|-----------------------------|--------------------------------|--|
| | | PREMIUM Twin-tube Oil | EXCEL-G Twin-tube Gas | GAS-A-JUST Mono-tube Gas | | PREMIUM Twin-tube Oil | EXCEL-G Twin-tube Gas | GAS-A-JUST Mono-tube Gas | |
| Peugeot (F) | | | | | | | | | |
| 505 | | | | | | | | | |
| GL, SL, GR, SR, GTi, GLD, GRD, SRD, SRD Turbo, GTD Turbo, GRD Turbo 1845001 → Turbo-injection Exc. ABS 1887752 → | 86 - | 665065 | | | | 444036 | | | |
| Turbo-injection ⊕ ABS 1965001 → | 87 - | | | | | 444036 | | | |
| 505 | | | | | | | | | |
| GL, GLD | 82 - 83 | 664008 913113 ▼ 910085 | | | | 444088 | | | |
| GR, SR, GRD, SRD GL, GTi, GLD, GTD Turbo → 1845000 | 82 - 86 84 - 86 | 664018 ¹⁾ 664008 ²⁾ 913113 ▼ 910085 | | | | 444088 | | | |
| GL, GR, GTi, GLD, GRD, GTD GTD Turbo, GRD Turbo 11845001 → | 86 - | 665065 913113 ▼ 910085 | | | | 444088 | | | |
| 1) Exc. = SHORT Lmax = 190 mm 2) ⊕ = SHORT Lmax = 180 mm | | | | | | | | | |
| 508 , 508 SW | | | | | | | | | |
| (8D_, 8E_) 1.6 THP (kW : 110, 115, 120), 1.6 VTi 1.6 HDi (82 kW, 84 kW), 2.0 BlueHDi 150 2.0 HDi (103 kW, 120 kW) Exc. | 11.10 - 12.18 | | | | | 3418000 917004 ⁴⁾ | | | |
| (8D_, 8E_) 1.6, 1.6 THP (121 kW) 1.6 BlueHDi 120, 1.6 HDi (85 kW) 2.0 BlueHDi 180, 2.0 HDi (100 kW), 2.2 HDi Exc. | 11.10 - 11.14 | | 341746 ¹⁾ | | | 3418000 917004 ⁴⁾ | | | |
| (8D_) 2.0 BlueHDi 180 Exc. | 11.14 - 12.18 | | 341746 ¹⁾ | | | 917004 ⁴⁾ | | | |
| (8E_) 2.0 BlueHDi 180 Exc. | 11.14 - 12.18 | | 341746 ¹⁾ | | | 3418000 917004 ⁴⁾ | | | |
| 1) 2) Exc. 2.0 BlueHDi 180, 2.2 HDi 3) ⊕ 2.0 BlueHDi 180, 2.2 HDi 4) Incl. Hybrid, RXH | | | | | | | | | |



| MODEL FAHRZEUG MODELE | YEAR JAHR ANNEE | FRONT/VORNE/AVANT | | | | REAR/HINTEN/ARRIERE | | | |
|--|------------------------------------|--|-----------------------------|--------------------------------|----------------------|-----------------------------|-----------------------------|--------------------------------|--|
| | | PREMIUM Twin-tube Oil | EXCEL-G Twin-tube Gas | GAS-A-JUST Mono-tube Gas | | PREMIUM Twin-tube Oil | EXCEL-G Twin-tube Gas | GAS-A-JUST Mono-tube Gas | |
| Peugeot (F) | | | | | | | | | |
| 508 , 508 SW | | | | | | | | | |
| (8D_, 8E_) 2.0 HDi 180 RXH 2.2 HDi Exc. | 10.14 - 12.18 11.14 - 12.18 | | 341746 ¹⁾ | | | | | | |
| | | SM1929 ²⁾ | | | 917004 ³⁾ | | | | |
| 1) 2) 2.0 BlueHDi 180, 2.2 HDi 3) Incl. Hybrid, RXH | | | | | | | | | |
| 604 | | | | | | | | | |
| SL, Ti, STi, Turbo Diesel → 6648440 | 74 - 3.82 | 664018 | | | | 444036 | | | |
| Ti, STi, GRD, SRD, Turbo-Diesel 6648441 → | 4.82 - 86 | 664008 | | | | 444036 | | | |
| 605 | | | | | | | | | |
| Exc. | 89 - 6.94 | | | | | 441088 | 341195 | | |
| | | 915909 MB1909 | | | | | | | |
| Exc. | 7.94 - 99 | | | | | 441088 | 341195 | | |
| | | 915909 MB1909 | | | | | | | |
| 607 | | | | | | | | | |
| 2.2 16V, 3.0 V6, 2.0 HDi, 2.2 HDi Exc. | 2.00 - | | 333948 L 333947 R | | | 441088 | 341195 | | |
| | | MB1909 | | | | | | | |
| 806 | | | | | | | | | |
| (221) | 94 - 1.98 | 634927 | 334927 | | | 443277 ¹⁾ | 343296 ¹⁾ ▼ | | |
| | | 910124 MB1907 SM1916 L SM1917 R | | | | | | | |
| (221) | 1.98 - 8.02 | 634927 | 334927 | | | 443303 ²⁾ | 343321 ²⁾ | | |
| | | 910124 MB1907 SM1916 L SM1917 R | | | | | | | |
| 1) L max. = 370mm 2) L max. = 400 mm | | | | | | | | | |
| 807 | | | | | | | | | |
| 2.0, 2.2, 3.0 V6 2.0 16V 2.0 HDi FAP, 2.2 HDi FAP 2.0 HDi | (E) 6.02 - 9.05 - 6.02 - 4.04 - | | 335934 L 335933 R | | | 443303 | 343321 | | |
| | | 910124 MB1907 SM1916 L SM1917 R | | | | | | | |



| MODEL FAHRZEUG MODELE | YEAR JAHR ANNEE | FRONT/VORNE/AVANT | | | | REAR/HINTEN/ARRIERE | | | |
|-----------------------------|-----------------------|-----------------------------|-----------------------------|--------------------------------|--|-----------------------------|-----------------------------|--------------------------------|--|
| | | PREMIUM Twin-tube Oil | EXCEL-G Twin-tube Gas | GAS-A-JUST Mono-tube Gas | | PREMIUM Twin-tube Oil | EXCEL-G Twin-tube Gas | GAS-A-JUST Mono-tube Gas | |

Peugeot (F)

1007

| | | | | | | | | |
|---------------------------|--------|--------|--|--|--|----------------------|--|--|
| 1.4 1.6 16V 1.4 HDi | 4.05 - | | 334826 L 334827 R | | | 343404 ¹⁾ | | |
| | | 910040 | MB1901 ¹⁾ SM1931 ¹⁾ | | | | | |

1) Incl. 1.6 HDi

2008 I

| | | | | | | | | |
|------------------------------|--------|--------|--|--|--|---------|--|--|
| Exc. Flex, Griffe Flex (CU_) | 3.13 - | | 3338003 L ¹⁾ 3338002 R ¹⁾ 3338005 L ²⁾ 3338004 R ²⁾ 3338056 L ³⁾ 3338055 R ³⁾ | | | 3438001 | | |
| | | 910260 | MB1901 | | | | | |

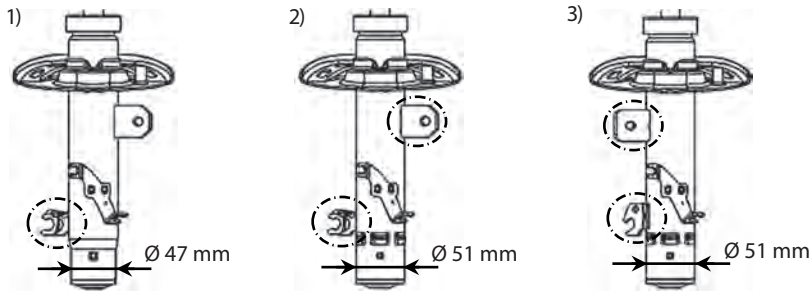

3008

| | | | | | | | | |
|--|-------------|--|----------------------|--|--|--------|--------|--|
| 1.6 THP, 1.6 VTi, 1.6 HDi, 2.0 HDi (OU_) Exc. | 6.09 - 6.14 | | 339829 L 339828 R | | | 345085 | | |
| | | 910067 ¹⁾ 910314 ¹⁾ | MB1901 SM1023 | | | 910095 | SM9912 | |
| 2.0 HDi Hybrid (OU_) | 2.11 - 6.14 | | 339829 L 339828 R | | | | SM9912 | |
| | | 910067 ¹⁾ 910314 ¹⁾ | MB1901 SM1023 | | | | | |

1)

| Engine Type | Engine Code | |
|-------------|-----------------------------|--------|
| Diesel | DV6_ | 910067 |
| | DW10_ | 910314 |
| Petrol | EP6, EP6C | 910067 |
| | EB2DT, EP6CD_, EP6D_, EP6F_ | 910314 |
| Hybrid | Hybrid4 | 910314 |

3008

| | | | | | | | | |
|----------------------------------|---------|--|---------|--|--|---------|--|--|
| Exc. Hybrid (M_) | 5.16 - | | 3348091 | | | 3448001 | | |
| | | | SM1055 | | | | | |
| 1.6 Hybrid (133 kW, 147 kW) (M_) | 10.19 - | | 3348091 | | | | | |
| | | | SM1055 | | | | | |



| MODEL FAHRZEUG MODELE | YEAR JAHR ANNEE | FRONT/VORNE/AVANT | | | | REAR/HINTEN/ARRIERE | | | |
|-----------------------------|-----------------------|-----------------------------|-----------------------------|--------------------------------|--|-----------------------------|-----------------------------|--------------------------------|--|
| | | PREMIUM Twin-tube Oil | EXCEL-G Twin-tube Gas | GAS-A-JUST Mono-tube Gas | | PREMIUM Twin-tube Oil | EXCEL-G Twin-tube Gas | GAS-A-JUST Mono-tube Gas | |

Peugeot (F)

4007

| | | | | | | | | |
|------------------|------|--------|------------------|----------------------|--|----------------|--|--|
| 2.2 HDi, 2.4 16V | (GP) | 2.07 - | | 339081 L 339080 R | | 349040 | | |
| | | | 935304 ▼ SM5657 | | | 910349 SM5091 | | |
| | | | 912053 | | | | | |

4008

| | | | | | | | | |
|--|--|-------------|--------------------------------|----------------------|--|--------|--|--|
| | | 5.12 - 7.13 | | 339254 L 339253 R | | 340060 | | |
| | | | 935304 ▼ SM5657 ¹⁾ | | | 910349 | | |
| | | | 912053 | | | | | |
| | | 8.13 - | | | | 340060 | | |
| | | | 935304 ▼ SM5657 ¹⁾ | | | 910349 | | |
| | | | 912053 | | | | | |

1)

5008 I

| | | | | | | | | |
|--|----------|--------------|-----------------------------|----------------------|--|---------|--|--|
| | (0U_0E_) | 6.09 - 11.13 | | 339807 L 339806 R | | 3458000 | | |
| | | | 910067 ¹⁾ MB1901 | | | | | |
| | | | 910314 ¹⁾ SM1023 | | | | | |

1)

| Engine Type | Engine Code | |
|-------------|----------------------|--------|
| Diesel | DV6_ | 910067 |
| | DW10_ | 910314 |
| Petrol | EB2DTS, EP6, EP6C | 910067 |
| | EP6CD_, EP6D_, EP6F_ | 910314 |

5008 II

| | | | | | | | | |
|--|--|---------|--|---------|--|---------|--|--|
| | | 12.16 - | | 3348091 | | 3448001 | | |
| | | | | SM1055 | | | | |

Partner, Partner Tepee, Ranch → Peugeot Commercial

RCZ

| | | | | | | | | |
|--|--|--------|--|--------|--|--|--------|--|
| | | 3.10 - | | | | | | |
| | | | | MB1901 | | | SM9902 | |

Rifter

| | | | | | | | | |
|--|--|--------|--|--------|--|--|--|--|
| | | 9.18 - | | | | | | |
| | | | | SM1055 | | | | |

Peugeot Commercial (F)

504

| | | | | | | | | |
|---------------|---------|--------|--|--|--|--------|--|--|
| → 3610000 | 79 - 82 | 665062 | | | | 445021 | | |
| 3610001 → | 82 - | | | | | 445021 | | |



| MODEL FAHRZEUG MODELE | YEAR JAHR ANNEE | FRONT/VORNE/AVANT | | | | REAR/HINTEN/ARRIERE | | | | | | | |
|--|-----------------------|-----------------------------|--|---|--|-----------------------------|--|--------------------------------|--|----------|----------|----------|----------|
| | | PREMIUM Twin-tube Oil | EXCEL-G Twin-tube Gas | GAS-A-JUST Mono-tube Gas | | PREMIUM Twin-tube Oil | EXCEL-G Twin-tube Gas | GAS-A-JUST Mono-tube Gas | | | | | |
| Peugeot Commercial (F) | | | | | | | | | | | | | |
| Bipper Tepee , Bipper | | | | | | | | | | | | | |
| | 2.08 - 7.12 | | 334968 L ▼ 334967 R ▼ 339809 L 339808 R | | | | 349145 | | | | | | |
| | | | 910112 | SM1821 L SM1822 R | | | | | | | | | |
| | 7.12 - | | 334968 L ▼ 334967 R ▼ 339809 L 339808 R | | | | | | | | | | |
| | | | 910112 | SM1821 L SM1822 R | | | | | | | | | |
| Boxer | | | | | | | | | | | | | |
| Incl. Exc. H/D, Camping Car | (230) 94 - 12.01 | 635806 | | | | | 344283 | | | | | | |
| | | | 910091 | MB1905 SM1920 ⁵⁾ SM1921 ⁵⁾ ¹⁾ | | | | | | | | | |
| Incl. Exc. H/D, Camping Car | (230) 94 - 12.01 | 635807 | | | | | 345021 | | | | | | |
| | | | 910096 | MB1905 SM1920 ⁵⁾ SM1921 ⁵⁾ ¹⁾ | | | | | | | | | |
| Exc. H/D | (244) 1.02 - 6.06 | 635806 | | | | | 344283 | | | | | | |
| | | | 910091 | MB1905 SM1926 L ⁶⁾ SM1927 R ⁶⁾ | | | | | | | | | |
| Exc. H/D | (244) 1.02 - 6.06 | 635807 | | | | | 345041 | | | | | | |
| | | | 910096 | MB1905 SM1926 L ⁶⁾ SM1927 R ⁶⁾ | | | | | | | | | |
| Incl. H/D, , , Camping car Exc. | 4.06 - | | 335827 ²⁾ | | | | 345700 ³⁾ 345701 ⁴⁾ | | | | | | |
| | | | 910159 | MB1905 SM1926 L ⁶⁾ SM1927 R ⁶⁾ | | | | | | | | | |
| <p>1) ← OE, (SG-704) 2) → 0.25mm</p> <p>3) 345700 : OE p/n = 5206TS, 5206TW, 5206LS, 5206VA, 5206VS, 5206VT, 5206LX</p> <p>4) 345701 : OE p/n = 5206TR, 5206TT, 5206TX, 5206LV, 5206VC, 5206VF, 5206NZ, 5206VG, 5206VH, 5206PF, 5206TY</p> <p>5) → →</p> <table border="1"> <tr> <td> SM1920 L</td> <td> SM1921 L</td> </tr> <tr> <td> SM1921 R</td> <td> SM1920 R</td> </tr> </table> <p>6) → 2.14</p> | | | | | | | | | | SM1920 L | SM1921 L | SM1921 R | SM1920 R |
| SM1920 L | SM1921 L | | | | | | | | | | | | |
| SM1921 R | SM1920 R | | | | | | | | | | | | |



| MODEL FAHRZEUG MODELE | YEAR JAHR ANNEE | FRONT/VORNE/AVANT | | | | REAR/HINTEN/ARRIERE | | | |
|-----------------------------|-----------------------|-----------------------------|-----------------------------|--------------------------------|--|-----------------------------|-----------------------------|--------------------------------|--|
| | | PREMIUM Twin-tube Oil | EXCEL-G Twin-tube Gas | GAS-A-JUST Mono-tube Gas | | PREMIUM Twin-tube Oil | EXCEL-G Twin-tube Gas | GAS-A-JUST Mono-tube Gas | |

Peugeot Commercial (F)

Expert

| | | | | | | | | | |
|---------|--------------|--------|--------------------------------|--|--|----------------------|-----------------------|--|--|
| → 7608 | 6.94 - 8.97 | 634928 | 334928 | | | 441106 ¹⁾ | 341238 ^{1)▼} | | |
| | | 910124 | MB1907 SM1916 L SM1917 R | | | | | | |
| 7609 → | 9.97 - 8.00 | 634928 | 334928 | | | 441107 ²⁾ | 341239 ²⁾ | | |
| | | 910124 | MB1907 SM1916 L SM1917 R | | | | | | |
| → 09792 | 9.00 - 10.03 | 634928 | 334928 | | | 441107 ²⁾ | 341239 ²⁾ | | |
| | | 910124 | MB1907 SM1916 L SM1917 R | | | | | | |

1) L max. = 370mm 2) L max. = 400 mm

Expert

| | | | | | | | | | |
|--------------------------------|-------------|--------|--------------------------------|--|--|--|---------|--|--|
| (VF3V_) Incl. , Exc. H/D | 1.07 - 2.09 | | 339772 L 339771 R | | | | 345078 | | |
| | | 910124 | MB1907 SM1916 L SM1917 R | | | | | | |
| (VF3V_) , H/D Exc. | 1.07 - 2.09 | | 339772 L 339771 R | | | | 345079 | | |
| | | 910124 | MB1907 SM1916 L SM1917 R | | | | | | |
| (VF3_) Incl. H/D, Exc. | 1.07 - 9.07 | | 339772 L 339771 R | | | | 345079 | | |
| | | 910124 | MB1907 SM1916 L SM1917 R | | | | | | |
| (VF3_) Incl. H/D, | 1.07 - 2.09 | | 339772 L 339771 R | | | | 345079 | | |
| | | 910124 | MB1907 SM1916 L SM1917 R | | | | | | |
| (VF3_) Incl. , H/D, | 2.09 - 3.13 | | 339772 L 339771 R | | | | 3448003 | | |
| | | 910124 | MB1907 SM1916 L SM1917 R | | | | | | |



| MODEL FAHRZEUG MODELE | YEAR JAHR ANNEE | FRONT/VORNE/AVANT | | | | REAR/HINTEN/ARRIERE | | | |
|-----------------------------|-----------------------|-----------------------------|-----------------------------|--------------------------------|--|-----------------------------|-----------------------------|--------------------------------|--|
| | | PREMIUM Twin-tube Oil | EXCEL-G Twin-tube Gas | GAS-A-JUST Mono-tube Gas | | PREMIUM Twin-tube Oil | EXCEL-G Twin-tube Gas | GAS-A-JUST Mono-tube Gas | |

Peugeot Commercial (F)

Expert / Traveller

| | | | | | | | | | |
|--|------|--------|--|--|--|--|---------|--|--|
| | (V_) | 4.16 - | | 3348085 ¹⁾ 3348084 ²⁾ | | | 3458001 | | |
|--|------|--------|--|--|--|--|---------|--|--|

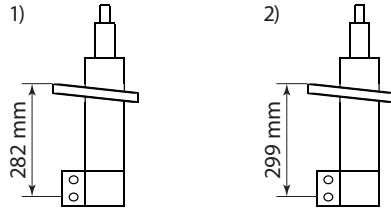

J5

| | | | | | | | | | |
|-------------------------------|---------|--------|--|--|--|--------|--|--|--|
| Incl. → 0244300 Exc. | 81 - 85 | 635850 | | | | 445022 | | | |
| Incl. → 0244300 → Exc. | 85 - 94 | 635851 | | | | 445022 | | | |
| 0244301 → 0327500 Exc. | 85 - 87 | 635851 | | | | 445022 | | | |
| 0327501 → Exc. | 87 - 94 | 635851 | | | | 445092 | | | |

J7

| | | | | | | | | | |
|---------|---------|--|--|--|--|---------|--|--|--|
| Fourgon | 66 - 80 | | | | | 443237▼ | | | |
|---------|---------|--|--|--|--|---------|--|--|--|

J9

| | | | | | | | | | |
|----------------------|---------|--|--|--|--|---------|--|--|--|
| Fourgon → 4161496 | 79 - 86 | | | | | 443237▼ | | | |
| Fourgon 4161497 → | 86 - 94 | | | | | 443237▼ | | | |

Partner, Ranch (96-)

| | | | | | | | | | |
|------|------------|----------------------|--|--|--|--------|--------|--|--|
| | 96 - 11.02 | 633839 L 633838 R | 333839 L 333838 R | | | 441105 | 341237 | | |
| | | 913112 | MB1901 SM1905 ¹⁾ SM1906 ²⁾ | | | | | | |
| | 96 - 11.02 | | 333839 L 333838 R | | | 441105 | 341237 | | |
| | | 913112 | MB1901 SM1905 ¹⁾ SM1906 ²⁾ | | | | | | |

1) ⊖ ⊕ 2) ⊕ ⊕



| MODEL FAHRZEUG MODELE | YEAR JAHR ANNEE | FRONT/VORNE/AVANT | | | | REAR/HINTEN/ARRIERE | | | |
|-----------------------------|-----------------------|-----------------------------|-----------------------------|--------------------------------|--|-----------------------------|-----------------------------|--------------------------------|--|
| | | PREMIUM Twin-tube Oil | EXCEL-G Twin-tube Gas | GAS-A-JUST Mono-tube Gas | | PREMIUM Twin-tube Oil | EXCEL-G Twin-tube Gas | GAS-A-JUST Mono-tube Gas | |

Peugeot Commercial (F)

Partner, Ranch (96-)

| | | | | | | | | | |
|----------|-----|--------------|--------|--|--|--------|--------|--|--|
| Exc. | (G) | 11.02 - 3.08 | | 333730 L 333729 R | | 441105 | 341237 | | |
| | | | 913112 | MB1901 ³⁾ SM1905 ¹⁾ SM1906 ²⁾³⁾ | | | | | |

1) 2) 3) Incl.

Partner Tepee/Ranch , Partner/Ranch (08-)

| | | | | | | | | | |
|----------------------------------|------|--------|--------|--|--|--|----------------------|--|--|
| Exc. 3rd seat row, H/D | (B9) | 4.08 - | | 338734 L 338733 R | | | | | |
| | | | 910067 | MB1901 SM1061 ¹⁾ | | | | | |
| 3rd seat row Exc. H/D | (B9) | 4.08 - | | 338734 L 338733 R | | | 349155 ³⁾ | | |
| | | | 910067 | MB1901 SM1061 ¹⁾ | | | | | |
| H/D | (B9) | 4.08 - | | 338736 L 338735 R | | | 349156 | | |
| | | | 910067 | MB1901 SM1061 ¹⁾ | | | | | |
| 500kg | (B9) | 4.08 - | | 338734 L ²⁾ 338733 R ²⁾ | | | 349157 | | |
| | | | 910067 | MB1901 SM1061 ¹⁾ | | | | | |
| Incl. LONG | (B9) | 4.08 - | | 338734 L ²⁾ 338733 R ²⁾ | | | 349155 ³⁾ | | |
| | | | 910067 | MB1901 SM1061 ¹⁾ | | | | | |



| MODEL FAHRZEUG MODELE | YEAR JAHR ANNEE | FRONT/VORNE/AVANT | | | | REAR/HINTEN/ARRIERE | | | |
|-----------------------------|-----------------------|-----------------------------|-----------------------------|--------------------------------|--|-----------------------------|-----------------------------|--------------------------------|--|
| | | PREMIUM Twin-tube Oil | EXCEL-G Twin-tube Gas | GAS-A-JUST Mono-tube Gas | | PREMIUM Twin-tube Oil | EXCEL-G Twin-tube Gas | GAS-A-JUST Mono-tube Gas | |

Peugeot Commercial (F)

Partner Tepee/Ranch , Partner/Ranch (08-)

| | | | | | | | | | |
|--|------|--------|--------|--|--|--|----------------------|--|--|
| | (B9) | 1.09 - | | 338734 L ²⁾ 338733 R ²⁾ | | | 349155 ³⁾ | | |
| | | | 910067 | MB1901 SM1061 ¹⁾ | | | | | |

1)

| | Application | kW | | →13145 →10.2012 | 13146 → 11.2012 → |
|------------------------|--------------------|--------|--------|--------------------|----------------------|
| DV6ATED4/DV6TED4 | 1.6 e-HDi/HDi | 66 | ∅ | ∅ | ∅ |
| DV6AUTED4 | 1.6 e-HDi/HDi, HDi | 68 | ∅ | ∅ | ∅ |
| DV6AUTED4/DV6TED4BU | 1.6 e-HDi/HDi, HDi | 66 | ∅ | ∅ | ∅ |
| DV6BTED4 | 1.6 HDi | 55 | ∅ | ∅ | ∅ |
| DV6BTED4/DV6BUTED4 | 1.6 HDi | 55 | ∅ | ∅ | ∅ |
| DV6C | 1.6 HDi | 82, 84 | ∅ | ∅ | SM1061 |
| DV6DTEd | 1.6 e-HDi/HDi, HDi | 68 | ∅ | ∅ | SM1061 |
| DV6DTEd | 1.6 e-HDi/HDi, HDi | 66 | SM1061 | ∅ | ∅ |
| DV6DTEd/DV6DTEdM | 1.6 HDi | 68 | ∅ | ∅ | SM1061 |
| DV6ETED/DV6ETEDM/DV6FE | 1.6 BlueHdi/HDi | 55 | ∅ | ∅ | SM1061 |
| DV6ETEDM/DV6FE | 1.6 BlueHdi/HDi | 55 | ∅ | ∅ | SM1061 |
| DV6FC | 1.6 BlueHdi | 88 | SM1061 | ∅ | ∅ |
| DV6FD | 1.6 BlueHdi | 73 | SM1061 | ∅ | ∅ |
| DV6TED4 | 1.6 HDi | 80 | ∅ | ∅ | ∅ |
| EB2DT | 1.2 THP | 81 | SM1061 | ∅ | ∅ |
| EP6C | 1.6, 1.6 VTi | 88 | ∅ | ∅ | SM1061 |
| EP6CB | 1.6 VTi | 72 | ∅ | ∅ | SM1061 |
| TU5JP4 | 1.6 | 80 | ∅ | ∅ | SM1061 |
| TU5JP4B | 1.6 | 66 | ∅ | ∅ | SM1061 |
| Y4F1 | Electric | 49 | ∅ | ∅ | ∅ |

2) Exc. Electric
3) 6.08 →

Partner (18-)

| | | | | | | | | | |
|-------------------------|------|--------|--|--------|--|--|----------|--|--|
| , Exc. e-Partner | (K9) | 9.18 - | | | | | 3418008◇ | | |
| | | | | SM1055 | | | | | |

Piaggio (I)

Porter

| | | | | | | | | | |
|----------------|------------------|------------------------|--|--|--|--------|--|--|--|
| 1.0 | 2.93 - | 633118 L 633117 R | | | | 443307 | | | |
| 1.0 | - 5.98 | 633118 L 633117 R | | | | 443401 | | | |
| 1.3 i | 5.98 - | 633262 L▼ 633261 R▼ | | | | 443401 | | | |
| 1.2 D 1.4 D | 5.98 - 5.98 - | 633262 L▼ 633261 R▼ | | | | 443402 | | | |

Plymouth (US) → Chrysler (US)

| | | | | | | | | | |
|--|--|--|--|--|--|--|--|--|--|
| | | | | | | | | | |
|--|--|--|--|--|--|--|--|--|--|

Pontiac (US) → General Motors (US)

| | | | | | | | | | |
|--|--|--|--|--|--|--|--|--|--|
| | | | | | | | | | |
|--|--|--|--|--|--|--|--|--|--|



Porsche

| MODEL FAHRZEUG MODELE | YEAR JAHR ANNEE | FRONT/VORNE/AVANT | | | | REAR/HINTEN/ARRIERE | | | |
|-----------------------------|-----------------------|-----------------------------|-----------------------------|--------------------------------|--|-----------------------------|-----------------------------|--------------------------------|--|
| | | PREMIUM Twin-tube Oil | EXCEL-G Twin-tube Gas | GAS-A-JUST Mono-tube Gas | | PREMIUM Twin-tube Oil | EXCEL-G Twin-tube Gas | GAS-A-JUST Mono-tube Gas | |

Porsche (D)

911, 914, 924, 928, 944

| | | | | | | | | | |
|-----------------------------------|-----------|--------|--------|--|--|--|--|--------|--|
| 911, 911 S, Carrera RS (Series E) | 9.71 - 74 | | 361004 | | | | | 554015 | |
| 914 | 7.69 - 76 | | 361004 | | | | | 551004 | |
| 924 Exc. sports drive | 76 - 7.84 | 663005 | 363014 | | | | | 553013 | |
| 944 | 81 - 7.84 | 663005 | 363014 | | | | | 553013 | |

Proton (MA)

Coupé

| | | | | | | | | | |
|-----|------|--|--|--|--|--|--------|--|--|
| 1.8 | 97 - | | 334098 L ¹⁾ ▼ 334097 R ²⁾ ▼ | | | | 341140 | | |
|-----|------|--|--|--|--|--|--------|--|--|

1) OE p/n = PW530083, PW530143, PW530241, PW530243

2) OE p/n = PW530084, PW530144, PW530242, PW530244

Persona Compact, 300 Series

| | | | | | | | | | |
|------------------------|------|--|------------------------|--|--|--|--------|--|--|
| 1.3, 1.5 (C96, C97) | 97 - | | 333225 L 333224 R | | | | 341140 | | |
| 1.6 (C98) | 97 - | | 334098 L▼ 334097 R▼ | | | | 341140 | | |

Persona, 400 Series, Wira

| | | | | | | | | | |
|------------------------------------|------------|--|--|--|--|--|--------|--|--|
| 1.3, 1.5 (C96, C97) | 93 - 11.95 | | 333125 L ¹⁾ 333124 R ²⁾ | | | | 341140 | | |
| 1.6 (C98) | 93 - 11.95 | | 334073 L ³⁾ 334072 R ⁴⁾ | | | | 341140 | | |
| 1.3, 1.5 (C96, C97) | 12.95 - | | 333225 L ⁵⁾ 333224 R ⁶⁾ | | | | 341140 | | |
| 1.6, 1.8, 2.0 D (C98, C99, C95) | 12.95 - | | 334098 L ⁷⁾ ▼ 334097 R ⁸⁾ ▼ | | | | 341140 | | |

1) OE p/n = MB891073

2) OE p/n = MB891074

3) OE p/n = MB891745

4) OE p/n = MB891746

5) OE p/n = PW530075, PW530077, PW530079, PW530081

6) OE p/n = PW530076, PW530078, PW530080, PW530082

7) OE p/n = PW530083, PW530143, PW530241, PW530243

8) OE p/n = PW530084, PW530144, PW530242, PW530244

Saga, Proton, Proton MPi

| | | | | | | | | | |
|----------|---------|--------|--|--|--|--------|--|--|--|
| 1.3, 1.5 | 85 - 96 | 633040 | | | | 443250 | | | |
|----------|---------|--------|--|--|--|--------|--|--|--|

Renault (F)

Avantime

| | | | | | | | | | |
|--------------------------------------|-------------|--|--|--|--|--|--|--|--|
| 2.0 i, 2.0 16V Turbo, 2.2 DCI, 3.0 i | 9.01 - 5.03 | | | | | | | | |
|--------------------------------------|-------------|--|--|--|--|--|--|--|--|

MB1901
 SM1525 L
 SM1524 R



| MODEL FAHRZEUG MODELE | YEAR JAHR ANNEE | FRONT/VORNE/AVANT | | | | REAR/HINTEN/ARRIERE | | | |
|---|-----------------------|--|--|--------------------------------|--|-----------------------------|-----------------------------|--------------------------------|--|
| | | PREMIUM Twin-tube Oil | EXCEL-G Twin-tube Gas | GAS-A-JUST Mono-tube Gas | | PREMIUM Twin-tube Oil | EXCEL-G Twin-tube Gas | GAS-A-JUST Mono-tube Gas | |
| Renault (F) | | | | | | | | | |
| Captur | | | | | | | | | |
| 0.9 TCe 90, 1.2 TCe 120 (J5_, H5_) 1.6 (I[] = H4M 429, H4M 438) 1.5 dCi, 1.5 dCi 90, 1.5 dCi 110 Incl. H/D, | 6.13 - | | 3338008 | | | | 3448002 | | |
| | | 910244 | SM1554 | | | | | | |
| 2.0 (4WD) (H5_) | 3.16 - | | 338737 | | | | 338738 | | |
| | | 910009 | MB1504 SM1528 | | | | SM1528 | | |
| Clio I (375*, 557*, 657*, B57*, C57*, S57*) | | | | | | | | | |
| 1.1 | 90 - 7.97 | 633824 ¹⁾ | 333824 ¹⁾ | | | | 341148 | 551054▼ | |
| | | 913237 | MB1504 SM1504 | | | | | | |
| 1.2 1.4 | 90 - 7.97 | 633824 ¹⁾ 633825 ¹⁾ | 333824 ¹⁾ 333825 ¹⁾ 323825 ¹⁾ | | | | 341148 | 551054▼ 241009 | |
| | | 913237 | MB1504 SM1504 ²⁾ SM1503 ³⁾ | | | | | | |
| 1.7, 1.8, 1.9 D Exc. 1.8 RSi, 1.8 16V | 90 - 7.97 | 633825 ¹⁾ | 333825 ¹⁾ 323825 ¹⁾ | | | | 341148 | 551054▼ 241009 | |
| | | 913237 | MB1504 SM1503 | | | | | | |
| 1.8 RSi (357E, 357V, C579, C57H) Exc. 1.8 16V | 90 - 7.97 | | 333825 ¹⁾ 323825 ¹⁾ | | | | | 551054▼ 241009 | |
| | | 913237 | MB1504 SM1503 | | | | | | |
| 1.2 1.4 | 7.97 - 98 | 633824 ¹⁾ 633706 ¹⁾ | 333824 ¹⁾ 333706 ¹⁾ | | | | 341148 | 551054▼ 241009 | |
| | | 913237 | MB1504 SM1504 ²⁾ SM1503 ³⁾ | | | | | | |
| 1.8, 1.9 D Exc. 1.8 RSi, 1.8 16V | 7.97 - 98 | 633706 ¹⁾ | 333706 ¹⁾ | | | | 341148 | 551054▼ 241009 | |
| | | 913237 | MB1504 SM1503 | | | | | | |
| <p>1) 2) SM1504 : 1.2L 3) SM1503 : 1.4L</p> <p>333824, 633824 : X = 52 mm 333825, 323825, 633825 : X = 54 mm 333706, 633706, 333849, 323849 : X = 58 mm</p> <p>633825 : exc. OE p/n = 7700 828 683, 7700 838 088 633706 : exc. OE p/n = 7700 423 729</p> | | | | | | | | | |



Renault

| MODEL FAHRZEUG MODELE | YEAR JAHR ANNEE | FRONT/VORNE/AVANT | | | REAR/HINTEN/ARRIERE | | |
|-----------------------------|-----------------------|-----------------------------|-----------------------------|--------------------------------|-----------------------------|-----------------------------|--------------------------------|
| | | PREMIUM Twin-tube Oil | EXCEL-G Twin-tube Gas | GAS-A-JUST Mono-tube Gas | PREMIUM Twin-tube Oil | EXCEL-G Twin-tube Gas | GAS-A-JUST Mono-tube Gas |

Renault (F)

Clio I (375*, 557*, 657*, B57*, C57*, S57*)

| | | | | | | | | | |
|-------------------------|--------------|-----------|----------------------|--|--|--|--|-------------------|--|
| 1.8 RSi Exc. 1.8 16V | (357V, C57H) | 7.97 - 98 | | 333706 ¹⁾ | | | | 551054▼ 241009 | |
| | | | 913237 | MB1504 SM1503 | | | | | |
| 1.8 16V | (C575, C57D) | 90 - 98 | | 333849 ¹⁾ 323849 ¹⁾ | | | | 551068 241010 | |
| | | | 913237 | MB1504 SM1503 | | | | | |
| 2.0 16V Williams | (C57M) | 90 - 98 | | | | | | 551068 241010 | |
| | | | | MB1504 SM1503 | | | | | |
| = Electric | (357W, 557W) | 90 - 7.97 | 633825 ¹⁾ | 333825 ¹⁾ | | | | | |
| | | | 913237 | MB1504 SM1503 | | | | | |
| = Electric | (357W, 557W) | 7.97 - 98 | 633706 ¹⁾ | 333706 ¹⁾ | | | | | |
| | | | 913237 | MB1504 SM1503 | | | | | |

1)

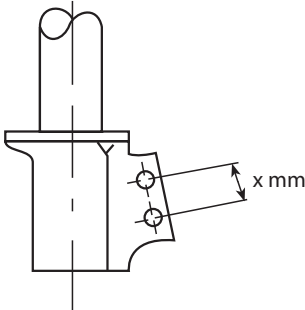

333824, 633824 : X = 52 mm
 333825, 323825, 633825 : X = 54 mm
 333706, 633706, 333849, 323849 : X = 58 mm

633825 : exc. OE p/n = 7700 828 683, 7700 838 088
 633706 : exc. OE p/n = 7700 423 729

Clio II (BB0*, CB0*, SB0*)

| | | | | | | | | | |
|---|--------|------|--------|-----------------------------|--|--|-----------------|--------|--|
| 1.2, 1.2 LPG | | 98 - | 633707 | 333707 | | | 343289 | | |
| | | | 913237 | MB1504 SM1507▼ SM1018 | | | 910068 SM9914 | | |
| 1.4, 1.6, 1.9 D, 1.9 DTI 1.2 16V, 1.5 dCi Exc. Sport sus. | | 98 - | 633708 | 333708 | | | 343289 | | |
| | | | 913237 | MB1504 SM1507▼ SM1018 | | | 910068 SM9914 | | |
| 1.4, 1.5 dCi, 1.6, 1.9 D, 1.9 DTI ⊕ Sport sus. | | 98 - | | 333708 | | | | 553225 | |
| | | | | OE=7700 428 115 | | | OE=7700 435 651 | | |
| | | | | MB1504 SM1507▼ SM1018 | | | | | |
| 1.6 16V | (CB0T) | 98 - | | 333708 | | | | 553225 | |
| | | | 913237 | MB1504 SM1507▼ SM1018 | | | 910068 | | |



| MODEL FAHRZEUG MODELE | YEAR JAHR ANNEE | FRONT/VORNE/AVANT | | | | REAR/HINTEN/ARRIERE | | | |
|-----------------------------|-----------------------|-----------------------------|-----------------------------|--------------------------------|--|-----------------------------|-----------------------------|--------------------------------|--|
| | | PREMIUM Twin-tube Oil | EXCEL-G Twin-tube Gas | GAS-A-JUST Mono-tube Gas | | PREMIUM Twin-tube Oil | EXCEL-G Twin-tube Gas | GAS-A-JUST Mono-tube Gas | |

Renault (F)

Clio II (BB0*, CB0*, SB0*)

| | | | | | | | | | |
|----------------|------|--|--|------------------|--|--|--|--------|--|
| 2.0 16V (CB0M) | 98 - | | | | | | | 553225 | |
| | | | | MB1504 SM1514 | | | | | |

Clio III

| | | | | | | | | | |
|--|--------|--|--|--|--|--|--------|--|--|
| | 9.05 - | 633744 | 333744 | | | | 344810 | | |
| | | 912025 ¹⁾ 910244 ¹⁾ | MB1509 SM1526 L ¹⁾ SM1527 R ¹⁾ SM1554 ¹⁾ | | | | | | |

Clio Grandtour

| | | | | | | | | | |
|--------------------------------|--------|--|--|--|--|--|--------|--|--|
| 1.2, 1.4, 1.5 dCi, 1.6 (KR0/1) | 2.08 - | 633744 | 333744 | | | | 344713 | | |
| | | 912025 ¹⁾ 910244 ¹⁾ | MB1509 SM1526 L ¹⁾ SM1527 R ¹⁾ SM1554 ¹⁾ | | | | | | |
| 1.2 16V Hi-Flex (KR0/1) | 7.08 - | | | 912025 ¹⁾ 910244 ¹⁾ | | | | | |
| | | | | MB1509 SM1526 L ¹⁾ SM1527 R ¹⁾ SM1554 ¹⁾ | | | | | |

1)

| | | | | | | | | | | | | | | | | | |
|--|---|---|---|---|---|---|---|---|---|----|----|----|----|----|----|----|----|
| | 1 | 2 | 3 | 4 | 5 | 6 | 7 | 8 | 9 | 10 | 11 | 12 | 13 | 14 | 15 | 16 | 17 |
| | - | - | - | - | - | - | - | - | - | - | - | - | - | - | - | - | - |

= F = / /
 = R = / /
 = W =
 =

| B | →5.10 SM1526 L / SM1527 R 912025 | →6.10 SM1526 L / SM1527 R 912025 | →3.10 SM1526 L / SM1527 R 912025 |
|---|------------------------------------|------------------------------------|------------------------------------|
| | 5.10 → SM1554 910244 | 6.10 → SM1554 910244 | 3.10 → SM1554 910244 |
| C | →5.10 SM1526 L / SM1527 R 912025 | →6.10 SM1526 L / SM1527 R 912025 | →3.10 SM1526 L / SM1527 R 912025 |
| | 5.10 → SM1554 910244 | 6.10 → SM1554 910244 | 3.10 → SM1554 910244 |
| K | →3.10 SM1526 L / SM1527 R 912025 | →3.10 SM1526 L / SM1527 R 912025 | →3.10 SM1526 L / SM1527 R 912025 |
| | 3.10 → SM1554 910244 | 3.10 → SM1554 910244 | 3.10 → SM1554 910244 |
| S | →5.10 SM1526 L / SM1527 R 912025 | ∅ | →3.10 SM1526 L / SM1527 R 912025 |
| | 5.10 → SM1554 910244 | | 3.10 → SM1554 910244 |

Clio IV

| | | | | | | | | | |
|--|---------|--|---------|--------|--|--|---------|--|--|
| Exc. Sport sus., , RS (BH_) | 11.12 - | | 3338037 | | | | 3448014 | | |
| | | | 910244 | SM1554 | | | | | |
| ⊕ Sport sus. Exc. Cup Chassis, RS (BH_) | 11.12 - | | | SM1554 | | | 3448013 | | |
| ⊕ Sport sus., Cup Chassis Exc. RS (BH_) | 11.12 - | | | SM1554 | | | 3448012 | | |



| MODEL FAHRZEUG MODELE | YEAR JAHR ANNEE | FRONT/VORNE/AVANT | | | | REAR/HINTEN/ARRIERE | | | |
|--|-----------------------|-----------------------------|-----------------------------|--------------------------------|--|-----------------------------|-----------------------------|--------------------------------|--|
| | | PREMIUM Twin-tube Oil | EXCEL-G Twin-tube Gas | GAS-A-JUST Mono-tube Gas | | PREMIUM Twin-tube Oil | EXCEL-G Twin-tube Gas | GAS-A-JUST Mono-tube Gas | |
| Renault (F) | | | | | | | | | |
| Clio IV Grandtour | | | | | | | | | |
| ALL Exc. Sport sus., | (KH_) 1.13 - | | 3338037 | | | | 3448014 | | |
| | | 910244 | SM1554 | | | | | | |
| ALL Sport sus. Exc. | (KH_) 1.13 - | | 3338036 | | | | 3448015 | | |
| | | | SM1554 | | | | | | |
| 1.5 dCi 110 Sport sus. Exc. Sport sus. | (KH_) 6.16 - | | 3338037 | | | | | | |
| | | 910244 | SM1554 | | | | | | |
| Dokker , Dokker Express | | | | | | | | | |
| 1.5 dCi, 1.6 Incl. H/D | 12.13 - | | 3338034 | | | | 344709 | | |
| | | | MB1504 SM1528 | | | | | | |
| ALL Exc. | 12.13 - | | 3338034 | | | | 344709 | | |
| | | | MB1504 SM1528 | | | | | | |
| ALL Sport sus. | 12.13 - | | 3338034 | | | | | | |
| | | | MB1504 SM1528 | | | | | | |
| Duster (HS) | | | | | | | | | |
| 2WD ALL | (HS) 2.12 - | | 338737 | | | | 343827 | | |
| | | 910009 | MB1504 SM1528 | | | 910229 | SM9916 | | |
| 4WD ALL | (HS) 6.11 - | | 338737 | | | | 338738 | | |
| | | 910009 | MB1504 SM1528 | | | | SM1528 | | |
| Duster (HM) | | | | | | | | | |
| 2WD 1.5 dCi 110 | (HM) 7.19 - | | 338737 | | | | 343827 | | |
| 4WD 1.5 dCi 110 | (HM) 7.19 - | | 338737 | | | | 338738 | | |
| Espace I | | | | | | | | | |
| J112 No T005813 → T036434 J115 No → T028296 J117 No → T003258 S112 No → T000620 S115 No → T000841 | 11.84 - 12.87 | 441080 ▼ | | | | | 443270 | 343266 ▼ | |
| J112 No T036435 → /K000001 → J115 No T028297 → J116 No T000001 → /K000001 → J117 No T003259 → S112 No T000621 → S115 No T000842 → | 1.88 - 3.91 | 441069 | 341110 | | | | 443270 | 343266 ▼ | |



| MODEL FAHRZEUG MODELE | YEAR JAHR ANNEE | FRONT/VORNE/AVANT | | | | REAR/HINTEN/ARRIERE | | | |
|--|-----------------------|-----------------------------|-----------------------------|--------------------------------|--|-----------------------------|-----------------------------|--------------------------------|--|
| | | PREMIUM Twin-tube Oil | EXCEL-G Twin-tube Gas | GAS-A-JUST Mono-tube Gas | | PREMIUM Twin-tube Oil | EXCEL-G Twin-tube Gas | GAS-A-JUST Mono-tube Gas | |
| Renault (F) | | | | | | | | | |
| Espace II | | | | | | | | | |
| 2.0, 2.2, 2.1TD, 2.8 V6, 2.9 V6, 3.0 V6 (J63) Exc. | 4.91 - 1.97 | 441069 | 341110 | | | 443270 | 343266▼ | | |
| Espace III | | | | | | | | | |
| = 2.70m 2.0, 1.9 D, 1.9 Dti (JE0A, JE0N, JE0M) | 96 - 02 | | 334821 | | | | | 553218 | |
| | | | | MB1901 SM1525 L SM1524 R | | | | | |
| = 2.87m 2.0, 1.9 D, 1.9 Dti (JE0A, JE0N, JE0M) | 96 - 02 | | 334821 | | | | | 553219 | |
| | | | | MB1901 SM1525 L SM1524 R | | | | | |
| = 2.70m 2.2 D, 3.0 V6 (JE0D, JE0E, JE0H, JE0P, JE0S) 2.2 DCI, 2.2 TD | 96 - 02 | | 334821 | | | | | 553219 | |
| | | | | MB1901 SM1525 L SM1524 R | | | | | |
| = 2.87m 2.2 D, 3.0 V6 (JE0D, JE0E, JE0H, JE0P, JE0S) 2.2 DCI, 2.2 TD | 96 - 02 | | 334821 | | | | | | |
| | | | | MB1901 SM1525 L SM1524 R | | | | | |
| = 2.70 m 2.0, 1.9 D, 1.9 Dti, 2.2 D, 3.0 V6 (JE0A, JE0D, JE0E, JE0H, JE0M, JE0N, JE0P, JE0S) 2.2 DCI, 2.2 TD | 96 - 02 | | 334821 | | | | | 553218 | |
| | | | | MB1901 SM1525 L SM1524 R | | | | | |
| = 2.87 m 2.0, 2.2 D, 3.0 V6 (JE0A, JE0D, JE0E, JE0H, JE0M, JE0N, JE0P, JE0S) 2.2 DCI, 2.2 TD | 96 - 02 | | 334821 | | | | | | |
| | | | | MB1901 SM1525 L SM1524 R | | | | | |
| = 2.70 m 3.0 V6 (JE0G) | 96 - 02 | | | OE=60 25 314 853/854 | | | OE=60 25 308 763 | 553218 | |
| | | | | MB1901 SM1525 L SM1524 R | | | | | |
| = 2.87 m 3.0 V6 (JE0G) | 96 - 02 | | | OE=60 25 314 853/854 | | | OE=60 25 314 022 | | |
| | | | | MB1901 SM1525 L SM1524 R | | | | | |
| = 2.70 m 3.0 V6 (JE0G) | 96 - 02 | | | OE=60 25 314 853/854 | | | OE=60 25 314 020 | | |
| | | | | MB1901 SM1525 L SM1524 R | | | | | |



Renault

| MODEL FAHRZEUG MODELE | YEAR JAHR ANNEE | FRONT/VORNE/AVANT | | | | REAR/HINTEN/ARRIERE | | | |
|---|-------------------------------|-----------------------------|--------------------------------|--------------------------------|--|-----------------------------|-----------------------------|--------------------------------|--|
| | | PREMIUM Twin-tube Oil | EXCEL-G Twin-tube Gas | GAS-A-JUST Mono-tube Gas | | PREMIUM Twin-tube Oil | EXCEL-G Twin-tube Gas | GAS-A-JUST Mono-tube Gas | |
| Renault (F) | | | | | | | | | |
| Espace IV | | | | | | | | | |
| ALL Exc. Self Leveling | (JK0/1_) 02 - 2.06 | 634814 | 334814 | | | | 344802 | | |
| | | 910044 | SM1529 | | | | | | |
| ALL Exc. | (JK0/1_) 3.06 - | | 339734 | | | | 344802 | | |
| | | 910092 | SM1529 | | | | | | |
| Espace V | | | | | | | | | |
| ALL Exc. Active sus. | (JR_) 2.15 - | | 3348075 | | | | 344707 | | |
| Fluence | | | | | | | | | |
| ALL Exc. Z.E. | (L30_) 2.10 - | | 339797 | | | | 3438003 | | |
| | | 912028 | SM1536 | | | | | | |
| Z.E. | (L30_) 2.12 - | | 3348007 | | | | 3448006 | | |
| | | 912028 | SM1536 | | | | | | |
| Kadjar | | | | | | | | | |
| 2WD ALL | (HA_, HL_) 6.15 - | | 3340173 L 3340172 R | | | | 349078 ¹⁾ | | |
| | | 910365 ³⁾ | SM1042 | | | | 3448029 ²⁾ | | |
| 4WD ALL | (HA_, HL_) 6.15 - | | 3340173 L 3340172 R | | | | 349078 ¹⁾ | | |
| | | 910365 ³⁾ | SM1042 | | | | | | |
| <p>1) = </p> <p>2) = </p> <p>3) phase 1 : 1.14 → 7.17</p> | | | | | | | | | |
| Koleos | | | | | | | | | |
| ALL | 9.08 - | | 339199 L 339198 R | | | | 349078 | 5540008 | |
| | | 910199 | MB1509 SM1546 L SM1545 R | | | | | | |
| Laguna I Exc. | | | | | | | | | |
| 1.8 (B56A, B56B, B56S, B56Z) 2.0 (B56C, B56H, B56N) Exc. 2.0S | ¹⁾ 12.93 - 4.95 | 634802 ²⁾ | 334802 ²⁾ | | | | | 551805 | |
| | | 945502 | MB1901 SM1525 L SM1524 R | | | | | | |
| 1.8 (B56A, B56B, B56S, B56T, B56Z) | ¹⁾ 4.95 - 3.01 | 634802 ²⁾ | 334802 ²⁾ | | | | | 551805 | |
| | | 945502 | MB1901 SM1525 L SM1524 R | | | | | | |



| MODEL FAHRZEUG MODELE | YEAR JAHR ANNEE | FRONT/VORNE/AVANT | | | REAR/HINTEN/ARRIERE |
|--|-----------------------|----------------------------------|--|--------------------------------|---------------------|
| | | PREMIUM Twin-tube Oil | EXCEL-G Twin-tube Gas | GAS-A-JUST Mono-tube Gas | |
| Renault (F) | | | | | |
| Laguna I Exc. | | | | | |
| 1.8 ⊕, ⊗, ⊕, ⊗, ⊕, ⊗ ABS (B560, B56B, B56S, B56T) | 1) 4.95 - 3.01 | 634802 ²⁾ ∞ 945502 | 334802 ²⁾ MB1901 SM1525 L SM1524 R | | 551805 |
| 1.8 ⊕, ⊗, ⊖, ⊗, ⊖, ⊗ ABS (B560, B56B, B56S, B56T) | 1) 4.95 - 3.01 | 634807 ³⁾ ∞ 945502 | 334807 ³⁾ ▼ MB1901 SM1525 L SM1524 R | | 551805 |
| 2.0 Exc. 2.0S (B56C, B56L) ⊕ (B56C) ⊕, ⊗, ⊕, ⊗ (B56C) ⊕, ⊗, ⊕, ⊗ ABS (B56H) ⊕, ⊗ (B56H) ⊕, ⊗ ABS (B56L) ⊕, ⊗, ⊕, ⊗ (B56L) ⊕, ⊗, ⊕, ⊗ ABS (B56N) ⊕, ⊗ ABS | 1) 4.95 - 3.01 | 634802 ²⁾ ∞ 945502 | 334802 ²⁾ MB1901 SM1525 L SM1524 R | | 551805 |
| 2.0 Exc. 2.0S (B56C) ⊕, ⊗, ⊖, ⊗, ⊖, ⊗ ABS (B56H) ⊖, ⊗, ⊖, ⊗ ABS (B56L) ⊕, ⊗, ⊕, ⊗, ⊖, ⊗ ABS (B56L) ⊕, ⊗, ⊖, ⊗, ⊖, ⊗ ABS | 1) 4.95 - 3.01 | 634807 ³⁾ ∞ 945502 | 334807 ³⁾ ▼ MB1901 SM1525 L SM1524 R | | 551805 |
| 1.6 16V (B561, B568) 1.9 dTi (B56J) 2.0S (B56D, B56M) 2.2 D/TD (B562, B566, B569, B56F) 3.0 (B56E, B56R) | 12.93 - 3.01 | 634802 ²⁾ ∞ 945502 | 334802 ²⁾ MB1901 SM1525 L SM1524 R | | 551805 |

1)

| | Model Type | -4.95 | 4.95- |
|---------|------------|----------------------|-----------------------|
| 1800 cc | B 560 | | S000001 → , E000001 → |
| | B 56A | → S023509 | S023510 → , E000001 → |
| | B 56B | → S060991, → E060293 | S060992 → , E060294 → |
| | B 56S | → S003274, → E012489 | S003275 → , E012490 → |
| | B 56T | | S000001 → , E000001 → |
| 2000 cc | B 56Z | → S000011 | S000012 → , E000001 → |
| | B 56C | → S059001, → E036671 | S059002 → , E036672 → |
| | B 56H | → S010453 | S010454 → , E000001 → |
| | B 56L | | S000001 → , E000001 → |
| | B 56N | → S001608 | S001609 → , E000001 → |

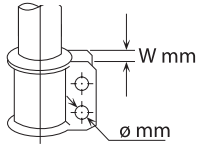
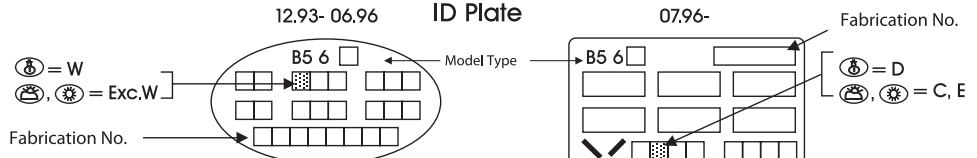

| | ø | W | KYB |
|----|-------|-------|----------------|
| 2) | 16 mm | 34 mm | 634802, 334802 |
| 3) | 14 mm | 24 mm | 634807, 334807 |



| MODEL FAHRZEUG MODELE | YEAR JAHR ANNEE | FRONT/VORNE/AVANT | | | | REAR/HINTEN/ARRIERE | | | |
|--|-----------------------|-----------------------------|--|--------------------------------|--|-----------------------------|-----------------------------|--------------------------------|--|
| | | PREMIUM Twin-tube Oil | EXCEL-G Twin-tube Gas | GAS-A-JUST Mono-tube Gas | | PREMIUM Twin-tube Oil | EXCEL-G Twin-tube Gas | GAS-A-JUST Mono-tube Gas | |
| Renault (F) | | | | | | | | | |
| Laguna I | | | | | | | | | |
| ALL Exc. | 95 - 3.01 | 634802 | 334802 | | | | | 551808 | |
| | | 945502 | MB1901 SM1525 L SM1524 R | | | | | Exc. | |
| Laguna I | | | | | | | | | |
| ALL | 12.93 - 3.01 | | 334802 | | | | | 551808 | |
| | | 945502 | MB1901 SM1525 L SM1524 R | | | | | Exc. | |
| Laguna II | | | | | | | | | |
| (B74, BG0_, BG_) 1.6 16V, 1.8 16V, 2.0 16V 2.0 Turbo, 3.0 V6, 1.9 dCi, 2.0 dCi, 2.2 dCi Exc. Sport sus. | 2.01 - | 633717 | 333717 | | | | | 553803 | |
| | | 910043 | SM1512 ¹⁾ SM1529 ²⁾ | | | | | | |
| (K74, KG0_) 1.6 16V, 1.8 16V, 2.0 16V 2.0 Turbo, 3.0 V6, 1.9 dCi, 2.0 dCi, 2.2 dCi Exc. Sport sus. | 2.01 - | 633717 | 333717 | | | | | 553803 | |
| | | 910043 | SM1512 ¹⁾ SM1529 ²⁾ | | | | | | |
| 1) 2.01- 2.05 2) 3.05- | | | | | | | | | |
| Laguna III | | | | | | | | | |
| (BT0/1) 1.6 16V, 2.0 16V, 2.0 16V Turbo 2.0 16V Hi-Flex, 1.5 dCi Exc. (Higher sus.), Sport sus. | 10.07 - | | 339704 | | | | | 344813 | |
| | | 910080 | SM1533 | | | | | | |
| (BT0/1) 2.0 dCi, 3.0 dCi, 3.5 Exc. (Higher sus.), Sport sus. | 10.07 - | | 339704 | | | | | 344813 | |
| | | 910080 | SM1533 | | | | | | |
| (KT0/1) 1.6 16V, 2.0 16V, 2.0 16V Turbo 2.0 16V Hi-Flex, 1.5 dCi Exc. (Higher sus.), Sport sus. | 10.07 - | | 339704 | | | | | 344813 | |
| | | 910080 | SM1533 | | | | | | |
| (KT0/1) 2.0 dCi, 2.0 GT, 3.0 dCi, 3.5 Exc. (Higher sus.), Sport sus. | 10.07 - | | 339704 ¹⁾ | | | | | 344813 | |
| | | 910080 | SM1533 | | | | | | |
| (DT0/1) 1.5 dCi, 2.0 16V Turbo, 2.0 GT, 2.0 dCi, 2.0 dCi GT, 3.0 dCi, 3.5 V6 | 9.08 - | | 339704 | | | | | 344813 ²⁾ | |
| | | 910080 | SM1533 | | | | | | |
| 1) Exc. 2.0 GT 2) Exc. 1.5 dCi, 2.0 dCi GT | | | | | | | | | |



| MODEL FAHRZEUG MODELE | YEAR JAHR ANNEE | FRONT/VORNE/AVANT | | | | REAR/HINTEN/ARRIERE | | | |
|--|-----------------------|-----------------------------|--|--------------------------------|--|-----------------------------|-----------------------------|--------------------------------|--|
| | | PREMIUM Twin-tube Oil | EXCEL-G Twin-tube Gas | GAS-A-JUST Mono-tube Gas | | PREMIUM Twin-tube Oil | EXCEL-G Twin-tube Gas | GAS-A-JUST Mono-tube Gas | |
| Renault (F) | | | | | | | | | |
| Latitude | | | | | | | | | |
| (L70_) 7.10 - | | | 3348009 L ¹⁾ 3348008 R ¹⁾ | | | 349238 | | | |
| | | 912028 | | | | | | | |
| 1) Color code : Blue | | | | | | | | | |
| Lodgy | | | | | | | | | |
| 5 Seater, 7 Seater Exc. | 7.13 - | | 3338023 | | | 3448005 | | | |
| | | MB1504 SM1528 | | | | | | | |
| | 7.13 - | | 3338034 | | | | | | |
| | | MB1504 SM1528 | | | | | | | |
| Logan | | | | | | | | | |
| 1.2, 1.4, 1.5 dCi, 1.6 (LS) 9.04 - | | | 338112 | | | 343418 | | | |
| | | 910009 MB1504 SM1528 | | | | 910229 SM9916 | | | |
| Logan II | | | | | | | | | |
| 1.2, 1.5 dCi, 1.6 (B8) 11.13 - Exc. | | | 338759 | | | 343833 | | | |
| | | MB1504 SM1528 | | | | 910229 SM9916 | | | |
| 1.2 LPG (B8) 11.13 - Exc. | | | 338759 | | | 343836 | | | |
| | | MB1504 SM1528 | | | | SM9916 | | | |
| 1.2, 1.5 dCi, 1.6 (B8) 11.13 - | | | 338749 | | | 343833 | | | |
| | | MB1504 SM1528 | | | | 910229 SM9916 | | | |
| Logan MCV | | | | | | | | | |
| 1.2, 1.4, 1.5 dCi, 1.6 (KS) 4.07 - | | | 338713 | | | 343482 | | | |
| | | 910009 MB1504 SM1528 | | | | 910229 SM9916 | | | |
| Logan MCV II | | | | | | | | | |
| 1.2, 1.5 dCi, 1.6 (B8) 12.13 - Exc. | | | 338759 | | | 343836 | | | |
| | | MB1504 SM1528 | | | | SM9916 | | | |
| 1.2 LPG (B8) 12.13 - Exc. | | | | | | 343418 | | | |
| | | MB1504 SM1528 | | | | SM9916 | | | |
| 1.2, 1.5 dCi, 1.6 (B8) 12.13 - | | | 338749 | | | 343418 | | | |
| | | MB1504 SM1528 | | | | SM9916 | | | |



| MODEL FAHRZEUG MODELE | YEAR JAHR ANNEE | FRONT/VORNE/AVANT | | | | REAR/HINTEN/ARRIERE | | | |
|-----------------------------|-----------------------|-----------------------------|-----------------------------|--------------------------------|--|-----------------------------|-----------------------------|--------------------------------|--|
| | | PREMIUM Twin-tube Oil | EXCEL-G Twin-tube Gas | GAS-A-JUST Mono-tube Gas | | PREMIUM Twin-tube Oil | EXCEL-G Twin-tube Gas | GAS-A-JUST Mono-tube Gas | |

Renault (F)

Mégane I, Mégane Classic

| | | | | | | | | |
|---------------------------------|----------------------|--------|--|--|--|--|------------------|--|
| (BA0/1, LA0/1) Exc. 2.0 16V, | 95 - 03 | 633827 | 333827 323827 | | | | 551804 241011 | |
| 2.0 16V Exc. | (BA0/1) 95 - 9.98 | | 334808 ¹⁾ 324808 ¹⁾ | | | | 551820 241012 | |
| 2.0 16V Exc. | (BA0/1) 10.98 - 8.03 | | 334830 ²⁾ | | | | 551820 | |

1) 334808, 324808 : x = 60 mm
2) 334830 : x = 54 mm

Mégane I, Mégane Coach

| | | | | | | | | |
|--------------------------------|-----------------------------|--------|--|--|--|--|------------------|--|
| (DA0/1, EA0/1) Exc. 2.0 16V | 96 - 03 | 633827 | 333827 323827 | | | | 551819 241012 | |
| 2.0 16V | (DA0/1, EA0/1) 96 - 9.98 | | 334808 ¹⁾ 324808 ¹⁾ | | | | 551820 241012 | |
| 2.0 16V | (DA0/1, EA0/1) 10.98 - 9.02 | | 334830 ²⁾ | | | | 551820 | |

1) 334808, 324808 : x = 60 mm
2) 334830 : x = 54 mm

Mégane I Grandtour

| | | | | | | | | |
|-----------------|-------------|--------|------------------|--|--|--|--------|--|
| (KA0/1) Exc. | 3.99 - 8.03 | 633827 | 333827 323827 | | | | 555800 | |
|-----------------|-------------|--------|------------------|--|--|--|--------|--|

Mégane II

| | | | | | | | |
|--|---------------|--------|--------|--|--|--------|--|
| 1.4, 1.6, 2.0, 2.0 16V 1.5 dCi, 1.9 dCi Exc. 2.0 Renault Sport Exc. Sport sus., | 10.02 - 11.08 | 633718 | 333718 | | | 344800 | |
| 1.4, 1.6, 2.0, 2.0 16V 1.5 dCi, 1.9 dCi Exc. 2.0 Renault Sport | 10.02 - 11.08 | | 338712 | | | 344814 | |



| MODEL FAHRZEUG MODELE | YEAR JAHR ANNEE | FRONT/VORNE/AVANT | | | | REAR/HINTEN/ARRIERE | | | |
|-----------------------------|-----------------------|-----------------------------|-----------------------------|--------------------------------|--|-----------------------------|-----------------------------|--------------------------------|--|
| | | PREMIUM Twin-tube Oil | EXCEL-G Twin-tube Gas | GAS-A-JUST Mono-tube Gas | | PREMIUM Twin-tube Oil | EXCEL-G Twin-tube Gas | GAS-A-JUST Mono-tube Gas | |

Renault (F)

Mégane II Grandtour

| | | | | | | | | | |
|--|-------------|--------|--------|--|--|--|--------|--|--|
| 1.4, 1.6, 2.0 1.5 dCi, 1.9 dCi, 2.0 dCi Exc. | 3.03 - 5.09 | 633718 | 333718 | | | | 344800 | | |
| | | 910042 | SM1517 | | | | | | |
| 1.4, 1.6, 2.0 1.5 dCi, 1.9 dCi, 2.0 dCi + | 3.03 - 5.09 | | 338712 | | | | 344814 | | |
| | | 910042 | SM1517 | | | | | | |

Mégane III

| | | | | | | | | | |
|--|-------------------|--------|----------------------|--|--|--|--|--|--|
| 1.2 TCe, 1.4 TCe, 2.0 TCe (132 kW) (BZ0_) 1.6 16V, 1.6 16V BiFuel 1.5 dCi, 1.6 dCi, 1.9 dCi 2.0 CVT Exc. Sport sus., , | 11.08 - | | 339724 ¹⁾ | | | | 344703 ²⁾ 344704 ³⁾ | | |
| | | 912024 | SM1535 ⁴⁾ | | | | | | |
| 2.0 dCi Exc. Sport sus., , | (BZ0_) 4.09 - | | | | | | 344703 ²⁾ | | |
| | | | | | | | | | |
| 1.2 TCe, 1.4 TCe, 1.6 16V, 1.6 16V BiFuel 1.5 dCi (kW : 66, 70, 78, 81), 1.6 dCi + Sport sus. Exc. , | (BZ0_) 11.08 - | | 339724 ¹⁾ | | | | 344703 ²⁾ | | |
| | | 912024 | SM1535 ⁴⁾ | | | | | | |

Mégane III Grandtour

| | | | | | | | | | |
|---|--------------------|--------|----------------------|--|--|--|----------------------|--|--|
| 1.2 TCe, 1.4 TCe 1.6 16V, 1.6 BiFuel, 1.6 16V BiFuel 1.5 dCi, 1.6 dCi, 1.9 dCi 2.0 CVT Exc. Sport sus., , | (KZ0/1) 11.08 - | | 339724 ¹⁾ | | | | | | |
| | | 912024 | SM1535 ⁴⁾ | | | | | | |
| 1.2 TCe, 1.4 TCe 1.6 16V, 1.6 BiFuel, 1.6 16V BiFuel 1.5 dCi (kW : 66, 70, 78, 81) 1.6 dCi, 1.9 dCi 2.0 CVT + Sport sus. Exc. , | (KZ0/1) 11.08 - | | 339724 ¹⁾ | | | | 344703 ²⁾ | | |
| | | 912024 | SM1535 ⁴⁾ | | | | | | |

1) 339724 OE p/n : 543020008R/16R/57R/58R

3) 344704 OE p/n : 562107002R

2) 344703 OE p/n : 562104554R/8685R

| Body | | Suspension |
|------|--|------------|
| | 2.0 TCe (132 kW), 2.0 dCi | Normal |
| | 1.2 TCe (85 kW), 1.4 TCe, 1.6 16V, 1.6 dCi, 1.6 16V BiFuel, 1.5 dCi (kW : 66, 70, 78, 81) | Sport |
| | 1.2 TCe, 1.4 TCe, 1.6 16V, 1.6 BiFuel, 1.6 16V BiFuel, 1.5 dCi (kW : 66, 70, 78, 81), 1.6 dCi, 1.9 dCi, 2.0 CVT | Sport |
| | 1.2 TCe, 1.4 TCe, 2.0 TCe (132 kW), 1.6 16V (81 kW), 1.6 16V BiFuel, 1.5 dCi, 1.6 dCi, 1.9 dCi, 2.0 dCi, 2.0 CVT | Normal |

| Body | | Suspension |
|------|---|------------|
| | 1.2 TCe (85 kW), 1.4 TCe, 1.6 16V (74 kW), 1.6 16V BiFuel, 2.0 CVT, 1.5 dCi (kW : 63, 66, 70, 78, 81), 1.6 dCi, 1.9 dCi | Normal |

4) Incl. 2.0 TCe (140 kW) , 2.0 dCi (120 kW)



| MODEL FAHRZEUG MODELE | YEAR JAHR ANNEE | FRONT/VORNE/AVANT | | | | REAR/HINTEN/ARRIERE | | | |
|-----------------------------|-----------------------|-----------------------------|-----------------------------|--------------------------------|--|-----------------------------|-----------------------------|--------------------------------|--|
| | | PREMIUM Twin-tube Oil | EXCEL-G Twin-tube Gas | GAS-A-JUST Mono-tube Gas | | PREMIUM Twin-tube Oil | EXCEL-G Twin-tube Gas | GAS-A-JUST Mono-tube Gas | |

Renault (F)

Mégane III

| | | | | | | | | | |
|---|---------|--|----------------------|--|--|--|----------------------|--|--|
| 1.2 TCe, 1.4 TCe, 2.0 TCe (132 kW) (DZ0/1) 1.6 16V (81 kW), 1.6 16V BiFuel 1.5 dCi, 1.6 dCi, 1.9 dCi 2.0 CVT Exc. Sport sus., , | 11.08 - | | 339724 ¹⁾ | | | | 344703 ²⁾ | | |
| | | | 912024 | | | | | | |
| | | | | | | | | | |
| 2.0 dCi (DZ0/1) Exc. Sport sus., , | 4.09 - | | | | | | 344703 ²⁾ | | |
| | | | | | | | | | |

1) 339724 OE p/n: 543020008R/16R/57R/58R

3) Incl. 2.0 TCe (140 kW) , 2.0 dCi (120 kW)

2) 344703 OE p/n: 562104554R/8685R

| Body | | Suspension |
|------|--|------------|
| | 2.0 TCe (132 kW), 2.0 dCi | Normal |
| | 1.2 TCe (85 kW), 1.4 TCe, 1.6 16V, 1.6 dCi, 1.6 16V BiFuel, 1.5 dCi (kW : 66, 70, 78, 81) | Sport |
| | 1.2 TCe, 1.4 TCe, 1.6 16V, 1.6 BiFuel, 1.6 16V BiFuel, 1.5 dCi (kW : 66, 70, 78, 81), 1.6 dCi, 1.9 dCi, 2.0 CVT | Sport |
| | 1.2 TCe, 1.4 TCe, 2.0 TCe (132 kW), 1.6 16V (81 kW), 1.6 16V BiFuel, 1.5 dCi, 1.6 dCi, 1.9 dCi, 2.0 dCi, 2.0 CVT | Normal |

Mégane CC

| | | | | | | | | | |
|-----------------------------|--------|--|---------|--|--|--|--|--|--|
| Exc. Sport sus. (EZ0/1) | 6.10 - | | 3348011 | | | | | | |
| | | | 912028 | | | | | | |
| | | | | | | | | | |

1) Exc. 2.0 Turbo

Mégane IV , Mégane IV Grandtour

| | | | | | | | | | |
|--|-----------------------------|--|---------|--|--|--|---------|--|--|
| Exc. 1.0 TCe 110, RS, E-TECH Exc. Sport sus., | (B9A/M_, K9A/M_) 11.15 - | | 3348092 | | | | 3448031 | | |
| | | | | | | | | | |
| | | | | | | | | | |
| Exc. 1.0 TCe 110, RS, E-TECH | (B9A/M_, K9A/M_) 11.15 - | | 3348087 | | | | 3448031 | | |
| | | | | | | | | | |
| | | | | | | | | | |
| 1.3 TCe 100 1.5 Blue dCi 95, 1.5 Blue dCi 115 1.8 Blue dCi 150 Sport sus. | (K9A/M_) 8.18 - | | | | | | 3448031 | | |
| | | | | | | | | | |
| | | | | | | | | | |



| MODEL FAHRZEUG MODELE | YEAR JAHR ANNEE | FRONT/VORNE/AVANT | | | | REAR/HINTEN/ARRIERE | | | |
|---|-----------------------|-----------------------------|---|--|--|-----------------------------|-----------------------------|--------------------------------|--|
| | | PREMIUM Twin-tube Oil | EXCEL-G Twin-tube Gas | GAS-A-JUST Mono-tube Gas | | PREMIUM Twin-tube Oil | EXCEL-G Twin-tube Gas | GAS-A-JUST Mono-tube Gas | |
| Renault (F) | | | | | | | | | |
| Mégane IV | | | | | | | | | |
| 1.2 TCe 130, 1.3 TCe 115 1.3 TCe 140, 1.6 SCe 1.5 Blue dCi 95, 1.5 Blue dCi 115 1.5 dCi 90, 1.5 dCi 110, 1.6 dCi 130 Exc. | 10.16- | | 3348092 | | | | 344707 ¹⁾ | | |
| | | | | SM1042 | | | | | |
| 1.2 TCe 130, 1.3 TCe 115 1.3 TCe 140, 1.6 SCe 1.5 dCi 90, 1.5 dCi 110, 1.6 dCi 130 | 10.16- | | 3348087 | | | | 344707 ¹⁾ | | |
| | | | | SM1042 | | | | | |
| 1) 1.5 Blue dCi 95, 1.5 Blue dCi 115 : | | | | | | | | | |
| | | | | | | | | | |
| Modus / Grand Modus | | | | | | | | | |
| 1.2, 1.4, 1.5 dCi, 1.6 (F/JPO) | 9.04- | | 333740 | | | | 344805 | | |
| | | | 912025 ¹⁾ 910244 ²⁾ | MB1509 SM1526 L ¹⁾ SM1527 R ¹⁾ SM1554 ²⁾ | | | | | |
| 1) → 6.10 2) 6.10 → | | | | | | | | | |
| R 4 | | | | | | | | | |
| (R-1120/1124) | 61 - 8.68 | | | | | 441004 | | 551045▼ | |
| (R-1120/1123/1124) | 9.68 - | 443032 | 343022 | | | 441004 | | 551045▼ | |
| GTL (R-1128) | 78 - | 443032 | 343022 | | | 441004 | | 551045▼ | |
| (F 4) (R-2105/2106/2109) | 9.68 - | 443032 | 343022 | | | | | 551029 | |
| (F 6) (R-2430/2370) | 75 - | 443032 | 343022 | | | | | 551029 | |
| R 5 | | | | | | | | | |
| Incl. Societe Exc. Alpine, Turbo (R-1223/122B) | 2.72 - 84 | 443032 | 343022 | | | 441030 | | | |



Renault

| MODEL FAHRZEUG MODELE | YEAR JAHR ANNEE | FRONT/VORNE/AVANT | | | | REAR/HINTEN/ARRIERE | | | |
|-----------------------------|-----------------------|-----------------------------|-----------------------------|--------------------------------|--|-----------------------------|-----------------------------|--------------------------------|--|
| | | PREMIUM Twin-tube Oil | EXCEL-G Twin-tube Gas | GAS-A-JUST Mono-tube Gas | | PREMIUM Twin-tube Oil | EXCEL-G Twin-tube Gas | GAS-A-JUST Mono-tube Gas | |

Renault (F)

R 5 (Super 5)

| | | | | | | | | | |
|--|-----------------------------|----------------------|------------------------|------------------|--|--------|--------|--|--|
| B 40, C 40, S 40 Exc. GT Turbo | 84 - 7.85 | | | | | 441056 | 341058 | | |
| | | | | MB1901 SM1500 | | | | | |
| B 40, C 40, S 40 Exc. GT Turbo, GTE | 8.85 - 5.88 | 633804 ¹⁾ | 333804 ¹⁾ ▼ | | | 441056 | 341058 | | |
| | | 912020 | | MB1901 SM1500 | | | | | |
| B 40, C 40, S 40 Exc. B/C 402, 408, 40G, 40K, S400 Exc. GT Turbo, Diesel | 6.88 - 3.95 | 633805 ²⁾ | 333805 ²⁾ | | | 441056 | 341058 | | |
| | | 912020 | | MB1901 SM1500 | | | | | |
| B 402, C 402, S 400 B408, C408, B40G, C40G, B40K, C40K | 6.88 - 3.95 | 633804 ¹⁾ | 333804 ¹⁾ ▼ | | | 441056 | 341058 | | |
| | | 912020 | | MB1901 SM1500 | | | | | |
| Diesel TD, GTD (B/C/S404) | 6.88 - 12.96 | 633804 ¹⁾ | 333804 ¹⁾ ▼ | | | 441056 | 341058 | | |
| | | 912020 | | MB1901 SM1500 | | | | | |
| GT Turbo (C405) | 84 - 8.85 | | | | | | 341068 | | |
| | | | | MB1901 SM1500 | | | | | |
| GT Turbo GTE (C405) (C409) | 9.85 - 5.87 10.86 - 8.91 | | 333061 | | | | 341068 | | |
| | | | | MB1901 SM1500 | | | | | |
| GT Turbo (C 405) | 6.87 - 5.91 | | | | | | 341068 | | |
| | | | | MB1901 SM1500 | | | | | |

1) 633804
333804

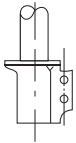

2) 633805
333805

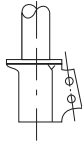

R 5 (Super 5) Express, Rapide, Extra → Renault Commercial

R 6

| | | | | | | | | | |
|--------------------|---------|--------|--|--|--|--------|--|--|--|
| ALL (R-1180, 1181) | 68 - 81 | 443032 | | | | 441004 | | | |
|--------------------|---------|--------|--|--|--|--------|--|--|--|

R 9, R 11

| | | | | | | | | | |
|---|---------|--------|---------|--------|--|--|--------|---------|--|
| R 9 2x() 1.1 (L 421) 1.2 (L 425) 1.4 (L 422/423/42A/42C/42R) 1.6 D (L 424) Exc. 1.4 Turbo (L 425) | 82 - 90 | 633807 | 333807▼ | | | | 343152 | 553141▼ | |
| | | 945502 | | MB1901 | | | | | |



| MODEL FAHRZEUG MODELE | YEAR JAHR ANNEE | FRONT/VORNE/AVANT | | | | REAR/HINTEN/ARRIERE | | | |
|--|-------------------------------|-----------------------------|-----------------------------|--------------------------------|--|-----------------------------|-----------------------------|--------------------------------|--|
| | | PREMIUM Twin-tube Oil | EXCEL-G Twin-tube Gas | GAS-A-JUST Mono-tube Gas | | PREMIUM Twin-tube Oil | EXCEL-G Twin-tube Gas | GAS-A-JUST Mono-tube Gas | |
| Renault (F) | | | | | | | | | |
| R 9, R 11 | | | | | | | | | |
| R 11 2x(0-0) 1.1 (B/C/S 371) 1.2 (B/C/S 375) 1.4 (B/C 372/373/37A/27C/37R) 1.4 (S 372/373/37A) 1.6 D (B/C/S 374) Exc. 1.4 Turbo (B/C 375) | 83 - 90 | 633807 | 333807▼ | | | | 343152 | 553141▼ | |
| R 9 2x(0-0) 1.7 → D003950, → H005600 (L 426) 1.7 → D000525 (L 42F) | 85 - 86 | 633807 | 333807▼ | | | | 343152 | 553141▼ | |
| R 11 2x(0-0) 1.4 Turbo → D001343 (B 375) 1.4 Turbo → D007886 (C 375) 1.4 Turbo → E002300 (C 375) | 84 - 86 | 633807 | 333807▼ | | | | 343152 | 553141▼ | |
| R 11 2x(0-0) 1.7 → D043789, → H017726 (B 376) 1.7 → D000644 (B 37F) 1.7 → D006418 (C 376) 1.7 → D000509 (C 37F) | 84 - 86 | 633807 | 333807▼ | | | | 343152 | 553141▼ | |
| R 9 4x(0-0) 1.7 D003951 →, H005601 → (L 426) 1.7 D000526 → (L 42F) | 86 - 90 | 633807 | 333807▼ | | | | 343207 | | |
| R 9 4x(0-0) 1.4 Turbo (L 425) | 85 - 90 | 633807 | 333807▼ | | | | 343207 | | |
| R 9 4x(0-0) 1.7 (L 42D/42E/42L/42N) | 85 - 90 | 633807 | 333807▼ | | | | 343207 | | |
| R 11 4x(0-0) 1.4 Turbo D001344 → (B 375) 1.4 Turbo D007887 → (C 375) 1.4 Turbo E002301 → (C 375) | 86 - 90 | 633807 | 333807▼ | | | | 343207 | | |
| R 11 4x(0-0) 1.7 D043790 →, H017727 → (B 376) 1.7 D000645 → (B 37F) 1.7 E006419 → (C 376) 1.7 E000510 → (C 37F) | 86 - 90 | 633807 | 333807▼ | | | | 343207 | | |
| R 11 4x(0-0) 1.7 D043790 →, H017727 → (B 376) 1.7 D000645 → (B 37F) 1.7 E006419 → (C 376) 1.7 E000510 → (C 37F) | 86 - 90 | 633807 | 333807▼ | | | | 343207 | | |
| R 11 4x(0-0) 1.7 (B/C 37D/37E/37L/37N) | 86 - 90 | 633807 | 333807▼ | | | | 343207 | | |
| R 12, R 15, R 17 | | | | | | | | | |
| R 12 (R-1170/1171/1177/1330) R 15 TL, TS, GTL (R-1300/1302) R 17 TL, TS (R-1312/1317/1322/1327) | 70 - 79 72 - 79 71 - 79 | 441013 | | | | 444031 | | | |



Renault

| MODEL FAHRZEUG MODELE | YEAR JAHR ANNEE | FRONT/VORNE/AVANT | | | | REAR/HINTEN/ARRIERE | | | |
|-----------------------------|-----------------------|-----------------------------|-----------------------------|--------------------------------|--|-----------------------------|-----------------------------|--------------------------------|--|
| | | PREMIUM Twin-tube Oil | EXCEL-G Twin-tube Gas | GAS-A-JUST Mono-tube Gas | | PREMIUM Twin-tube Oil | EXCEL-G Twin-tube Gas | GAS-A-JUST Mono-tube Gas | |

Renault (F)

R 14

| | | | | | | | | | |
|---|-----------|--------|--|--|--|--------|--|--|--|
| TL, GTL → 345946 (R-1210) LS, TS → 7533 (R-1211) | 5.76 - 78 | 664004 | | | | 441030 | | | |
| TL, GTL 345947 → (R-1210/1213) LS, TS 7534 → (R-1211/1212) | 78 - 83 | | | | | 441030 | | | |

R 18

| | | | | | | | | | |
|--|---|--|--|--|--|---------|---------|--|--|
| TL, GTL → 552000 (R-1340) TS, GTS → 559400 (R-1341) TS, GTS → 20609 (R-1342) | 79 - 84 79 - 84 79 - 83 | | | | | 443205▼ | 343179▼ | | |
| TX, GTX → 3200 (R 1343) TD, GTD → 190905 (R x1344) | - 83 80 - 84 | | | | | 443205▼ | 343179▼ | | |
| TL, GTL 552001 → (R 1340) TS, GTS 559401 → (R 1341) TS, GTS 20610 → (R 1342) TX, GTX 3201 → (R 1343) TD, GTD 190906 → (R 1344) Turbo = (R 1345) Turbo Diesel = (R 1346) | 84 - 86 84 - 86 84 - 86 84 - 86 84 - 86 82 - 86 84 - 86 | | | | | 443205▼ | 343179▼ | | |

R 19 / Chamade

| | | | | | | | | | |
|---------------------------|-----------|--------|------------------|--|--|--|----------------------|--|--|
| 2x Exc. 1.8 16V | 9.88 - 95 | 633808 | 333808 323808 | | | | 343233 ²⁾ | | |
| 4x Exc. 1.8 16V | 9.88 - 95 | 633808 | 333808 323808 | 945502 MB1901 SM1515 ¹⁾ | | | 343234 ³⁾ | | |
| R 19 / Chamade 1.8 16V | 9.88 - 95 | | | 945502 MB1901 | | | | | |

1) SM1515 : Exc. B/C/L 532

2)

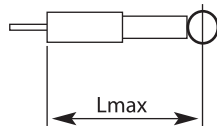

L max. = 524mm

3)

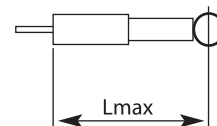

L max. = 563mm

R 21

| | | | | | | | | | |
|---|---------|--------|---------|---|--|--------|--------|--|--|
| 1.4 (L48D, B48D) 1.7 (L48 1/2/E/F/M/N, B48 1/2/E/F) 1.9 D (L48 H/I, B48H/I) | 86 - 94 | 631004 | 331002▼ | | | 441057 | 341100 | | |
| 2.0 (L483, L48C, L48R) 2.2 (L48K) 2.1 D (L486, L480, L48V) | 86 - 94 | | | 943130▼ MB1901 SM1508▼ 943130▼ MB1901 SM1508 ¹⁾ ▼ SM1509 ¹⁾ | | 441057 | 341100 | | |



| MODEL FAHRZEUG MODELE | YEAR JAHR ANNEE | FRONT/VORNE/AVANT | | | REAR/HINTEN/ARRIERE | PREMIUM Twin-tube Oil | EXCEL-G Twin-tube Gas | GAS-A-JUST Mono-tube Gas | PREMIUM Twin-tube Oil | EXCEL-G Twin-tube Gas | GAS-A-JUST Mono-tube Gas |
|---|--|-----------------------------|-----------------------------|--------------------------------|---------------------|-----------------------------|-----------------------------|--------------------------------|-----------------------------|-----------------------------|--------------------------------|
| | | PREMIUM Twin-tube Oil | EXCEL-G Twin-tube Gas | GAS-A-JUST Mono-tube Gas | | | | | | | |
| Renault (F) | | | | | | | | | | | |
| R 21 (2WD) | | | | | | | | | | | |
| 2.0 (L483, L48C, L48R) 2.2 (L48K) 2.1 D (L486, L480, L48V) | 86 - 94 | 635903 L 635902 R | | | | 441057 | 341100 | | | | |
| 2.0 (L48Q, L48Y) 2.1 D (L480, B48 0/6/O/V) 2.1 TD (L48 7/8/A/P/W) Exc. 2.0 Turbo (L48 5/L) | 86 - 94 | 635903 L 635902 R | | | | 441057 | 341100 | | | | |
| 2.0 (B48 3/C/R/Y) 2.2 (B48K) 2.1 TD (B48 7/8/A/P/W) | 86 - 94 | 635903 L 635902 R | | | | | 341100 | | | | |
| R 21 Nevada, Soci t  (2WD) | | | | | | | | | | | |
| 1.7 (K48 1/2/E/F/M/N, S481, S482) 1.9 D (K48 H/I, S48 H) | 86 - | 631004 | 331002▼ | | | | 341964 | | | | |
| 2.0 (K483, K48C) 2.2 (K48K) 2.1 D (K48 6/O/V, S48V) | 86 - | | | | | | 341964 | | | | |
| 1) | Model | Year | KYB | | | | | | | | |
| 2.0 | B48K / B48Y / B483 K48B / K48R / K48S / K489 L48Q / L48S / L48Y | 86 - | SM1509 | | | | | | | | |
| 2.0 | B48C / B48R K48C / L48C / L48K | 86 - | SM1508 | | | | | | | | |
| 2.0 | B48C / B48R K48C / L48C / L48K | 86 - | SM1509 | | | | | | | | |
| 2.0 | K48K / K483 L48K / L48R / L483 / L489 | 86 - 4.89 | SM1508 | | | | | | | | |
| 2.0 | K48K / K483 L48K / L48R / L483 / L489 | 5.89 - | SM1509 | | | | | | | | |
| 2.1 D / TD | B48A / B48P / B48W / B480 / B486 / B487 / B488 K48A / K48P / K48W / K480 / K487 L48A / L48P / L48W / L480 / L487 | 86 - | SM1509 | | | | | | | | |
| 2.1 D / TD | B480 / B48V K480 / K48V S480 / S48V / S486 | 86 - | SM1508 | | | | | | | | |
| 2.1 D / TD | B480 / B48V K480 / K48V S480 / S48V / S486 | 86 - | SM1509 | | | | | | | | |
| 2.1 D / TD | K486 / K488 L48V / L486 / L488 | 86 - 4.89 | SM1508 | | | | | | | | |
| 2.1 D / TD | K486 / K488 L48V / L486 / L488 | 5.89 - | SM1509 | | | | | | | | |



| Renault | MODEL FAHRZEUG MODELE | YEAR JAHR ANNEE | FRONT/VORNE/AVANT | | | REAR/HINTEN/ARRIERE | |
|--|--|-----------------------|--|-----------------------------|--------------------------------|---------------------|-----------------------------|
| | | | PREMIUM Twin-tube Oil | EXCEL-G Twin-tube Gas | GAS-A-JUST Mono-tube Gas | | PREMIUM Twin-tube Oil |
| Renault (F) | | | | | | | |
| R 21 Nevada, Société (2WD) | | | | | | | |
| Société 2.1 D | (S486, S480) | 86 - | | | | 341964 | |
| | | | 943130 ▼ MB1901 SM1508 ¹⁾ ▼ SM1509 ¹⁾ | | | | |
| 2.0 2.2 2.1 D ⊕ ⊕ | (K48 3/C) (K48K) (K48 6/O/V, S48V) | 86 - | 635903 L 635902 R | | | 341964 | |
| | | | 943130 ▼ MB1901 SM1508 ¹⁾ ▼ SM1509 ¹⁾ | | | | |
| 2.0 2.2 2.1 D 2.1 TD | (K48R) (K48B) (K480) (K48 7/8/A/P/W) | 86 - | 635903 L 635902 R | | | 341964 | |
| | | | 943130 ▼ MB1901 SM1508 ¹⁾ ▼ SM1509 ¹⁾ | | | | |
| 1) | | | | | | | |
| | Model | Year | KYB | | | | |
| 2.0 | B48K / B48Y / B483 K48B / K48R / K48S / K489 L48Q / L48S / L48Y | 86 - | SM1509 | | | | |
| 2.0 | B48C / B48R K48C / L48C / L48K ⊖ ⊕ | 86 - | SM1508 | | | | |
| 2.0 | B48C / B48R K48C / L48C / L48K ⊕ ⊕ | 86 - | SM1509 | | | | |
| 2.0 | K48K / K483 L48K / L48R / L483 / L489 | 86 - 4.89 | SM1508 | | | | |
| 2.0 | K48K / K483 L48K / L48R / L483 / L489 | 5.89 - | SM1509 | | | | |
| 2.1 D / TD | B48A / B48P / B48W / B480 / B486 / B487 / B488 K48A / K48P / K48W / K480 / K487 L48A / L48P / L48W / L480 / L487 | 86 - | SM1509 | | | | |
| 2.1 D / TD | B480 / B48V ⊖ ⊕ K480 / K48V ⊖ ⊕ S480 / S48V / S486 ⊖ ⊕ | 86 - | SM1508 | | | | |
| 2.1 D / TD | B480 / B48V ⊕ ⊕ K480 / K48V ⊕ ⊕ S480 / S48V / S486 ⊕ ⊕ | 86 - | SM1509 | | | | |
| 2.1 D / TD | K486 / K488 L48V / L486 / L488 | 86 - 4.89 | SM1508 | | | | |
| 2.1 D / TD | K486 / K488 L48V / L486 / L488 | 5.89 - | SM1509 | | | | |
| R 25 Exc. | | | | | | | |
| Incl. V6, Diesel Turbo | | 11.83 - 92 | 441058 | | | 334661 | |
| Safrane I & II (2WD) Exc. | | | | | | | |
| Safrane I Safrane II | | 92 - 96 96 - | | 334961 | | 333962 | |
| | | | 945502 MB1901 | | | SM9501 | |
| Sandero | | | | | | | |
| 1.2, 1.2 LPG, 1.6, 1.6 Bifuel 1.5 dCi | | 11.07 - | | 338713 | | 348008 ▼ 343418 | |
| | | | 910009 MB1504 SM1528 | | | SM9916 | |



| MODEL FAHRZEUG MODELE | YEAR JAHR ANNEE | FRONT/VORNE/AVANT | | | | REAR/HINTEN/ARRIERE | | | |
|---|-----------------------|-----------------------------|--|--------------------------------|--|--|-----------------------------|--------------------------------|--|
| | | PREMIUM Twin-tube Oil | EXCEL-G Twin-tube Gas | GAS-A-JUST Mono-tube Gas | | PREMIUM Twin-tube Oil | EXCEL-G Twin-tube Gas | GAS-A-JUST Mono-tube Gas | |
| Renault (F) | | | | | | | | | |
| Sandero II | | | | | | | | | |
| 1.2 16V, 1.6 (kW : 59, 60, 61) 1.5 dCi Exc. Stepway, H/D, | (B8_) 11.13- | | 338759 910009 MB1504 SM1528 | | | 343833 SM9916 | | | |
| 1.2 16V LPG Exc. Stepway | (B8_) 12.13- | | 338759 910009 MB1504 SM1528 | | | 343833 ³⁾ 343836 ⁴⁾ SM9916 | | | |
| 1.6 (83 kW) Exc. Stepway, | (B8_) 9.16- | | 3338042 910009 MB1504 SM1528 | | | 343834 SM9916 | | | |
| 1.6 16V (75 kW) Exc. Stepway | (B8_) 4.14- | | 338759 910009 MB1504 SM1528 | | | SM9916 | | | |
| 1.2 16V, 1.6 (kW : 59, 60, 61) 1.5 dCi ⊕ H/D Exc. Stepway, | (B8_) 11.13- | | 338759 ¹⁾ 338749 ²⁾ 910009 MB1504 SM1528 | | | 343833 SM9916 | | | |
| 1.2 16V, 1.6 (kW : 59, 60, 61, 83) 1.5 dCi ⊕ Exc. Stepway, H/D | (B8_) 11.13- | | 338749 910009 MB1504 SM1528 | | | 343833 SM9916 | | | |
| Sandero Stepway II | | | | | | | | | |
| 1.6 (kW : 59, 61, 83), 1.6 16V (75 kW) (B8_) 1.5 dCi Exc. H/D, | 11.13- | | 3338042 910009 MB1504 SM1528 | | | 343834 | | | |
| 1.6 (60 kW) Exc. H/D, | (B8_) 11.13- | | 338759 910009 MB1504 SM1528 | | | 343833 | | | |
| 1.6 (60 kW) ⊕ H/D Exc. | (B8_) 11.13- | | 338759 ¹⁾ 338749 ²⁾ 910009 MB1504 SM1528 | | | 343833 | | | |
| 1.6 (60 kW, 83 kW) ⊕ Exc. H/D | (B8_) 11.13- | | 338749 910009 MB1504 SM1528 | | | 343833 | | | |
| 1) | 2) | 3) | 4) | | | | | | |



Renault

| MODEL FAHRZEUG MODELE | YEAR JAHR ANNEE | FRONT/VORNE/AVANT | | | REAR/HINTEN/ARRIERE |
|--|-----------------------|-----------------------------|-----------------------------|--------------------------------|---|
| | | PREMIUM Twin-tube Oil | EXCEL-G Twin-tube Gas | GAS-A-JUST Mono-tube Gas | |
| Renault (F) | | | | | |
| Scénic I (96-03) 🚗 | | | | | |
| Scénic I Ⓜ 1.4, 1.6 Exc. (4WD) | (JA) 96 - 9.98 | 633827 | 333827 | MB1901 SM1515 | 551807 |
| Scénic I 1.6 Ⓜ 1.9 D, 1.9 DT, 1.9 DTI, 2.0 16V Exc. (4WD) | (JA) 96 - 9.98 | 634600 | 334660 | MB1901 SM1515 | 551807 |
| Scénic I 🚗 | | | | | |
| Ⓜ (2WD) | (JA0/1) 10.98 - 5.03 | 633827 | 333827 | MB1901 SM1515 | 551807 |
| (4WD) RX4 1.8, 1.9 dCi, 2.0 i Exc. Ⓜ | (JA0/1) 9.99 - 4.03 | | 334837 | SM1515 | 344809 |
| Scénic II, Grand Scénic II 🚗 | | | | | |
| Ⓜ Exc. Ⓜ | (JM0/1) 6.03 - | | 334831 | SM1517 | 344804 |
| Scénic III, Grand Scénic III 🚗 | | | | | |
| Grand Scénic III Ⓜ Incl. Ⓜ Exc. Ⓜ | 2.09 - | | 339762 | SM1535 | 344706 |
| Scénic III Ⓜ Incl. Ⓜ Exc. Ⓜ | 2.09 - | | 339762 | SM1535 | 344707 |
| Scénic IV, Grand Scénic IV 🚗 | | | | | |
| Ⓜ Incl. Hybrid Assist | (J9_, R9_) 9.16 - | | 3348087 | | 344707 |
| Talisman 🚗, Talisman Grantour 🚗 | | | | | |
| 1.3 TCe 60, 1.6 TCe 150 1.6 TCe 200, 1.8 TCe 225 1.5 dCi 110, 1.6 dCi 130, 1.6 dCi 160 1.7 Blue dCi 120, 1.7 Blue dCi 150 2.0 Blue dCi 160, 2.0 Blue dCi 200 Exc. H/D, Ⓜ, Ⓜ | (LP_, KP_) 11.15 - | | 3348086 | | 3448030 |
| Thalia, Symbol 🚗 | | | | | |
| 1.2 16V | (LB0/1/2) 4.02 - | 633707 ¹⁾ | 333707 ¹⁾ | MB1504 SM1507▼ SM1018 | 443398 ³⁾ 343289 ³⁾ |



| MODEL FAHRZEUG MODELE | YEAR JAHR ANNEE | FRONT/VORNE/AVANT | | | | REAR/HINTEN/ARRIERE | | | |
|--|-----------------------|-----------------------------|-----------------------------|--------------------------------|--|-----------------------------|-----------------------------|--------------------------------|--|
| | | PREMIUM Twin-tube Oil | EXCEL-G Twin-tube Gas | GAS-A-JUST Mono-tube Gas | | PREMIUM Twin-tube Oil | EXCEL-G Twin-tube Gas | GAS-A-JUST Mono-tube Gas | |
| Renault (F) | | | | | | | | | |
| Thalia, Symbol | | | | | | | | | |
| 1.4i (LB0/1/2) | 8.00 - | | 333742 | | | 443398 ³⁾ | 343289 ³⁾ | | |
| | | | | | | | | | |
| 1.4i 16V, 1.6i 16V, 1.5 dCi (LB0/1/2) | 8.00 - | 6338001 ⁴⁾ | 333743 ²⁾ | | | 443398 ³⁾ | 343289 ³⁾ | | |
| | | | | | | | | | |
| 1.6 (66 kW) (LB0/1/2) | 3.98 - | | | | | | | | |
| | | | | | | | | | |
| 1.9 D (LB0/1/2) | 2.98 - 5.01 | 633708 ²⁾ | 333708 ²⁾ | | | 443398 ³⁾ | 343289 ³⁾ | 553225 | |
| 1) 333707, 633707 : x = 52 mm 2) 333708, 333743, 633708 : x = 58 mm 3) 4) Exc. | | | | | | | | | |
| | | | | | | | | | |
| Thalia II, Symbol II | | | | | | | | | |
| 1.2 16V, 1.2 LPG, 1.4 (55 kW) (LU1/2_) | 9.08 - | 633707 ¹⁾ | 333707 ¹⁾ | | | 443398 | 343289 | | |
| 1.4 (72 kW) | | | | | | | | | |
| 1.6 (79 kW) (LU1/2_) | 9.08 - | 6338001 ³⁾ | 333743 ²⁾ | | | 443398 | 343289 | | |
| 1.5 dCi (47 kW, 62 kW) | | | | | | | | | |
| 1.6 16V (77 kW) (LU1D/LU2M) | 9.08 - | 6338001 ³⁾ | 333743 ²⁾ | | | | | | |
| | | | | | | | | | |
| 1.6 16V (77 kW) | 9.08 - | | | | | 443398 | 343289 | | |
| 1.5 dCi (48 kW) | | | | | | | | | |
| 0.9 Tce, 1.5 dCi (55 kW, 66 kW) (LU1/2_) | 11.12 - 6.14 | | | | | | | | |
| | | | | | | | | | |
| 1) 333707, 633707 : x = 52 mm 2) 333743 : x = 58 mm 3) Exc. | | | | | | | | | |
| | | | | | | | | | |
| Thalia III, Symbol III | | | | | | | | | |
| 0.9 TCe, 1.2 16V, 1.2 LPG (L8_) | 12.13 - | | 338759 | | | | 343833 | | |
| 1.5 dCi (55 kW, 66 kW) Exc. | | | | | | | | | |
| 1.2 16V, 1.2 LPG (L8_) | 12.13 - | | 338749 | | | | 343833 | | |
| 1.5 dCi (55 kW, 66 kW) | | | | | | | | | |



| Renault | MODEL FAHRZEUG MODELE | YEAR JAHR ANNEE | FRONT/VORNE/AVANT | | | | REAR/HINTEN/ARRIERE | | | |
|---|-----------------------------|-----------------------|-----------------------------|--|--------------------------------|--|-----------------------------|-----------------------------|--------------------------------|--|
| | | | PREMIUM Twin-tube Oil | EXCEL-G Twin-tube Gas | GAS-A-JUST Mono-tube Gas | | PREMIUM Twin-tube Oil | EXCEL-G Twin-tube Gas | GAS-A-JUST Mono-tube Gas | |
| Renault (F) | | | | | | | | | | |
| Twingo | | | | | | | | | | |
| 1.1, 1.2 (C/S 063, 064, 066, 067, 068) | 3.93 - 9.00 | | | 333714 | | | | 341813 | | |
| | | | 913237 | MB1504 SM1504 | | | 915501 | SM9500 | | |
| 1.1, 1.2 (C/S 063, 064, 066, 067, 068) (C/S 06C, 06D, 06G, 06K) | 10.00 - 8.04 | | | 333724 L 333723 R 328701 L 328700 R | | | | 341813 351702 | | |
| | | | 913237 | MB1504 SM1504 | | | 915501 | SM9500 | | |
| 1.2 16V | 8.04 - | | | 333724 L 333723 R 328701 L 328700 R | | | | 341813 351702 | | |
| | | | 913237 | MB1504 SM1504 | | | 915501 | SM9500 | | |
| Twingo II (CNO) 1.2, 1.2 16V, 1.2 16V Turbo, 1.5 dCi | 3.07 - | | | 338701 | | | | 343822 | | |
| | | | 912022 913237 | MB1504 SM1507 SM1018 | | | | | | |
| Twingo II (CNO) 1.6 RS | 5.08 - | | | | | | | | | |
| | | | | | MB1504 SM1514 | | | | | |
| Twingo III (BCM) Incl. Sport sus. Exc. Electric, GT | 9.14 - | | | 3338022 | | | | 3438007 | | |
| | | | | | | | | | | |
| Twingo III (BCM) 0.9 TCe GT Incl. Sport sus. | 11.16 - | | | | | | | 3438008 | | |
| | | | | | | | | | | |
| Vel Satis | | | | | | | | | | |
| 2.0 16V, 2.0 Turbo, 2.0 dCi, 2.2 dCi, 3.0 dCi, 3.5 V6 | 6.02 - | | 634814 | 334814 | | | | 344801 | | |
| | | | 910044 | SM1529 | | | | | | |
| Wind | | | | | | | | | | |
| (E4M_) | 7.10 - | | | 3338010 | | | | 3438004 | | |
| | | | | | MB1504 SM1514 | | | | | |
| Zoe | | | | | | | | | | |
| (BFM) | 6.12 - | | | 3338009 | | | | 3448004 | | |
| | | | 910244 | SM1554 | | | | | | |



| MODEL FAHRZEUG MODELE | YEAR JAHR ANNEE | FRONT/VORNE/AVANT | | | | REAR/HINTEN/ARRIERE | | | |
|---|-----------------------|-----------------------------|-----------------------------|--------------------------------|--|-----------------------------|-----------------------------|--------------------------------|--|
| | | PREMIUM Twin-tube Oil | EXCEL-G Twin-tube Gas | GAS-A-JUST Mono-tube Gas | | PREMIUM Twin-tube Oil | EXCEL-G Twin-tube Gas | GAS-A-JUST Mono-tube Gas | |
| Renault Commercial (F) | | | | | | | | | |
| Kangoo | | | | | | | | | |
| (FC0_, KC0_) Exc. 2/4 Torsion bar, | 97 - | 633848 | 333848 | | | | | 551810 ¹⁾ | |
| | | 913237 | MB1504 SM1507▼ SM1018 | | | | | | |
| (FC0_, KC0_) ⊕ 2/4 Torsion bar Exc. | 97 - | 633848 | 333848 | | | | | 551811 ²⁾ | |
| | | 913237 | MB1504 SM1507▼ SM1018 | | | | | | |
| (FC0_, KC0_) ⊕ Pampa Exc. | 97 - | 633848 | 333848 | | | | | 551811 ²⁾ | |
| | | | MB1504 SM1507▼ SM1018 | | | | | | |
| (KC0/1_, FC0/1_) 1.6 16V 4x4 1.9 dCi 4x4 | 1.02 - | | 338700 | | | | 344812 | | |
| | | 913237 | MB1504 SM1507▼ SM1018 | | | | | | |
| <p>1) Ø 40 mm</p> <p>2) Ø 50 mm</p> | | | | | | | | | |
| Kangoo II, Grand Kangoo II, Kangoo II Be Bop | | | | | | | | | |
| Kangoo II (KW0/1) 1.6 (64 kW), 1.6 16V, 1.6 16V Hi-Flex, 1.5 dCi, 1.5 dCi 110 (80 kW) | 2.08 - | | 3348010 ¹⁾ | | | | 344709 | | |
| | | 910135 | MB1509 SM1534 | | | | | | |
| Grand Kangoo II (KW0/1) 1.6 (64 kW), 1.6 16V, 1.6 16V Hi-Flex, 1.5 dCi, 1.5 dCi 110 (80 kW) Incl. | 2.08 - | | 339766 ¹⁾³⁾ | | | | 344709 ⁴⁾ | | |
| | | 910135 | MB1509 SM1534 | | | | | | |
| Kangoo II, Grand Kangoo II (KW0/1) 1.6 (64 kW), 1.6 16V, 1.6 16V Hi-Flex, 1.5 dCi, 1.5 dCi 110 (80 kW) | 2.08 - | | 3338011 ²⁾ | | | | | | |
| | | 910135 | MB1509 SM1534 | | | | | | |
| Kangoo II, Grand Kangoo II (KW0/1) 1.6 (74 kW), 1.6 CNG, 1.6 LPG Incl. H/D | 2.08 - | | 339766 ¹⁾ | | | | 344709 | | |
| | | 910135 | MB1509 SM1534 | | | | | | |
| Kangoo II Be Bop (KW0/1) | 2.09 - | | 3348010 ¹⁾ | | | | 344709 | | |
| | | 910135 | MB1509 SM1534 | | | | | | |
| <p>1) Ø 51 mm</p> <p>2) Ø 47 mm</p> <p>3) Grand Kangoo II 1.6 16V Normal sus. : 3.08 →</p> <p>4) Grand Kangoo II 1.5 dCi (78 kW) Normal sus. : → 9.12</p> | | | | | | | | | |



| MODEL FAHRZEUG MODELE | YEAR JAHR ANNEE | FRONT/VORNE/AVANT | | | | REAR/HINTEN/ARRIERE | | | |
|-----------------------------|-----------------------|-----------------------------|-----------------------------|--------------------------------|--|-----------------------------|-----------------------------|--------------------------------|--|
| | | PREMIUM Twin-tube Oil | EXCEL-G Twin-tube Gas | GAS-A-JUST Mono-tube Gas | | PREMIUM Twin-tube Oil | EXCEL-G Twin-tube Gas | GAS-A-JUST Mono-tube Gas | |

Renault Commercial (F)

Kangoo II Express, Kangoo II Express Compact, Kangoo II Express Maxi

| | | | | | | | | |
|--|-------------|--------|-----------------------|--|--|--|--|--|
| Kangoo II Express (FW0/1) 1.6, 1.5 dCi 75, 1.5 dCi 90, 1.5 dCi 110 (80 kW) ⊕ Exc. H/D, | 2.08 - 7.12 | | 3338011 ²⁾ | | | | | |
| | | 910135 | MB1509 SM1534 | | | | | |
| Kangoo II Express (FW0/1) 1.6 16V, 1.6 CNG, 1.6 Hi-Flex, 1.6 LPG, 1.5 dCi, 1.5 dCi 85 ⊕ Exc. H/D, | 2.08 - | | 3338011 ²⁾ | | | | | |
| | | 910135 | MB1509 SM1534 | | | | | |
| Kangoo II Express (FW0/1) 1.6, 1.5 dCi 75, 1.5 dCi 90, 1.5 dCi 110 (80 kW) ⊕ , Exc. H/D, | 2.08 - 9.12 | | 339766 ¹⁾ | | | | | |
| | | 910135 | MB1509 SM1534 | | | | | |
| Kangoo II Express (FW0/1) 1.6 16V, 1.6 CNG, 1.6 Hi-Flex, 1.6 LPG, 1.5 dCi, 1.5 dCi 85 ⊕ , Exc. H/D, | 2.08 - | | 339766 ¹⁾ | | | | | |
| | | 910135 | MB1509 SM1534 | | | | | |
| Kangoo II Express (FW0/1) 1.6, 1.5 dCi 75, 1.5 dCi 90, 1.5 dCi 110 (80 kW) ⊕ ⊕ H/D, | 2.08 - | | 339766 ¹⁾ | | | | | |
| | | 910135 | MB1509 SM1534 | | | | | |
| Kangoo II Express (FW0/1) 1.6, 1.5 dCi 75, 1.5 dCi 90, 1.5 dCi 110 (80 kW) ⊕ , ⊕ H/D, | 2.08 - 9.12 | | 339766 ¹⁾ | | | | | |
| | | 910135 | MB1509 SM1534 | | | | | |
| Kangoo II Express (FW0/1) 1.6 16V, 1.6 CNG, 1.6 Hi-Flex, 1.6 LPG, 1.5 dCi, 1.5 dCi 85 ⊕ H/D, | 2.08 - | | 339766 ¹⁾ | | | | | |
| | | 910135 | MB1509 SM1534 | | | | | |
| Kangoo II Express Compact (FW0/1) 1.6, 1.5 dCi 75, 1.5 dCi 90, 1.5 dCi 110 (80 kW) Exc. H/D, | 2.08 - 7.12 | | 3338011 ²⁾ | | | | | |
| | | 910135 | MB1509 SM1534 | | | | | |
| Kangoo II Express Compact (FW0/1) 1.6 16V, 1.6 CNG, 1.6 Hi-Flex, 1.6 LPG, 1.5 dCi, 1.5 dCi 85 Exc. H/D, | 2.08 - | | 3338011 ²⁾ | | | | | |
| | | 910135 | MB1509 SM1534 | | | | | |
| Kangoo II Express Maxi (FW0/1) 1.6, 1.5 dCi 75, 1.5 dCi 90, 1.5 dCi 110 (80 kW) Exc. H/D, | 2.08 - 9.12 | | 339766 ¹⁾ | | | | | |
| | | 910135 | MB1509 SM1534 | | | | | |



| MODEL FAHRZEUG MODELE | YEAR JAHR ANNEE | FRONT/VORNE/AVANT | | | | REAR/HINTEN/ARRIERE | | | |
|--|-----------------------|-----------------------------|--------------------------------|--------------------------------|--|-----------------------------|-----------------------------|--------------------------------|--|
| | | PREMIUM Twin-tube Oil | EXCEL-G Twin-tube Gas | GAS-A-JUST Mono-tube Gas | | PREMIUM Twin-tube Oil | EXCEL-G Twin-tube Gas | GAS-A-JUST Mono-tube Gas | |
| Renault Commercial (F) | | | | | | | | | |
| Kangoo II Express, Kangoo II Express Compact, Kangoo II Express Maxi | | | | | | | | | |
| Kangoo II Express Maxi (FW0/1) 1.6 16V, 1.6 CNG, 1.6 Hi-Flex, 1.6 LPG, 1.5 dCi, 1.5 dCi 85 Exc. H/D, | 2.08 - | | 339766 ¹⁾ 910135 | MB1509 SM1534 | | | | | |
| 1.6 16V LPG (FW0/1) Incl. H/D, | 2.08 - | | 339766 ¹⁾ 910135 | MB1509 SM1534 | | | | | |
| Kangoo Z.E., Kangoo Maxi Z.E. (FW0/1) | 10.11 - | | 339766 ¹⁾ 910135 | MB1509 SM1534 | | | | | |
| 1.2 TCe 115 (FW0/1) | 7.13 - | | 339766 ¹⁾ 910135 | | | | | | |
| <div style="display: flex; justify-content: space-around;"> <div style="text-align: center;"> <p>1)</p> <p>Ø 51 mm</p> </div> <div style="text-align: center;"> <p>2)</p> <p>Ø 47 mm</p> </div> </div> | | | | | | | | | |
| Kangoo II Express, Kangoo II Express Compact, Kangoo II Express Maxi | | | | | | | | | |
| Kangoo II Express (FW0/1) 1.6 (64 kW), 1.6 16V, 1.6 CNG, 1.5 dCi, 1.5 dCi 75, 1.5 dCi 85, 1.5 dCi 90, 1.5 dCi 110 (80 kW) Exc. H/D, | 2.08 - | | | | | | 3448010 | | |
| Kangoo II Express (FW0/1) 1.6 (64 kW), 1.6 16V, 1.6 CNG, 1.5 dCi, 1.5 dCi 75, 1.5 dCi 85, 1.5 dCi 90, 1.5 dCi 110 (80 kW) Exc. H/D, | 2.08 - | | | | | | 344709 | | |
| Kangoo II Express (FW0/1) 1.6 (64 kW), 1.6 16V, 1.6 CNG, 1.5 dCi, 1.5 dCi 75, 1.5 dCi 85, 1.5 dCi 90, 1.5 dCi 110 (80 kW) H/D, | 2.08 - | | | | | | 344709 | | |
| Kangoo II Express (FW0/1) 1.6 (75 kW), 1.6 Hi-Flex, 1.6 LPG H/D | 10.12 - | | | | | | 344709 | | |
| Kangoo II Express (FW0/1) 1.6 (75 kW), 1.6 Hi-Flex, 1.6 LPG | 2.08 - 9.12 | | | | | | 344709 | | |
| Kangoo II Express Compact (FW0/1) 1.6 (64 kW), 1.6 16V, 1.6 CNG, 1.5 dCi, 1.5 dCi 75, 1.5 dCi 85, 1.5 dCi 90, 1.5 dCi 110 (80 kW) Exc. H/D, | 2.08 - | | | | | | 3448010 | | |



Renault

| MODEL FAHRZEUG MODELE | YEAR JAHR ANNEE | FRONT/VORNE/AVANT | | | | REAR/HINTEN/ARRIERE | | | |
|-----------------------------|-----------------------|-----------------------------|-----------------------------|--------------------------------|--|-----------------------------|-----------------------------|--------------------------------|--|
| | | PREMIUM Twin-tube Oil | EXCEL-G Twin-tube Gas | GAS-A-JUST Mono-tube Gas | | PREMIUM Twin-tube Oil | EXCEL-G Twin-tube Gas | GAS-A-JUST Mono-tube Gas | |

Renault Commercial (F)

Kangoo II Express, Kangoo II Express Compact, Kangoo II Express Maxi

| | | | | | | | | | |
|--|--------------|--|--|--|--|--|---------|--|--|
| Kangoo II Express Maxi (FW0/1) 1.6 (64 kW), 1.6 16V, 1.6 CNG, 1.5 dCi, 1.5 dCi 75, 1.5 dCi 85, 1.5 dCi 90, 1.5 dCi 110 (80 kW) Exc. H/D, | 2.08 - | | | | | | 344709 | | |
| 1.6 (75 kW), 1.6 Hi-Flex, 1.6 LPG (FW0/1) Exc. H/D, | 2.08 - 6.12 | | | | | | 3448010 | | |
| 1.6 (75 kW), 1.6 Hi-Flex, 1.6 LPG (FW0/1) Exc. H/D, | 10.12 - | | | | | | 344709 | | |
| 1.6 (75 kW), 1.6 Hi-Flex, 1.6 LPG (FW0/1) , Exc. H/D, | 2.08 - | | | | | | 344709 | | |
| 1.6 16V LPG (FW0/1) Incl. H/D | 2.08 - | | | | | | 344709 | | |
| Kangoo Z.E., Kangoo Maxi Z.E. (FW0/1) | 10.11 - 9.12 | | | | | | 344709 | | |

Master Q Series

| | | | | | | | | | |
|--|---------|--------|--|--|--|--|--|--------|--|
| | 81 - 98 | 441965 | | | | | | 551071 | |
|--|---------|--------|--|--|--|--|--|--------|--|

Master R Series

| | | | | | | | | | |
|---------------|-----------|--------|--|--|--|--|--|--|--|
| → B066692 | 81 - 2.89 | 441965 | | | | | | | |
| B066693 → | 3.89 - 97 | 441966 | | | | | | | |

Master R Series

| | | | | | | | | | |
|----------------------------|-----------|--|--|--|--|--|--|----------------------|--|
| | 81 - 2.89 | | | | | | | 553213 ¹⁾ | |
| | 3.89 - 97 | | | | | | | 553214 ¹⁾ | |
| (RC7*, RL7*) | 81 - 97 | | | | | | | 551071 ¹⁾ | |
| (RC9*, RD9*, RL9*) Exc. | 81 - 94 | | | | | | | 551071 ¹⁾ | |
| (RC9*, RD9*, RL9*) Exc. | 94 - 97 | | | | | | | 553214 ¹⁾ | |
| (RH9*, RJ9*) | 81 - 2.89 | | | | | | | 553213 ¹⁾ | |



| MODEL FAHRZEUG MODELE | YEAR JAHR ANNEE | FRONT/VORNE/AVANT | | | | REAR/HINTEN/ARRIERE | | | | | | | | | | | | | | |
|---|--------------------------------|-----------------------------|-----------------------------|--------------------------------|--|-----------------------------|-----------------------------|--------------------------------|--|--|------|-------|--|------------------------------|--------|------------------------------|--------|--|--------------|--------|
| | | PREMIUM Twin-tube Oil | EXCEL-G Twin-tube Gas | GAS-A-JUST Mono-tube Gas | | PREMIUM Twin-tube Oil | EXCEL-G Twin-tube Gas | GAS-A-JUST Mono-tube Gas | | | | | | | | | | | | |
| Renault Commercial (F) | | | | | | | | | | | | | | | | | | | | |
| Master R Series | | | | | | | | | | | | | | | | | | | | |
| (RH9*, RJ9*) | 3.89 - 97 | | | | | | | 553214 ¹⁾ | | | | | | | | | | | | |
| 1) <table border="1"> <tr> <td></td> <td>OE =</td> <td>KYB =</td> </tr> <tr> <td rowspan="2"></td> <td>5005 387 175 5000 388 797</td> <td>553213</td> </tr> <tr> <td>7700 748 642 6006 000 216</td> <td>553214</td> </tr> <tr> <td></td> <td>6006 000 215</td> <td>551071</td> </tr> </table> | | | | | | | | | | | OE = | KYB = | | 5005 387 175 5000 388 797 | 553213 | 7700 748 642 6006 000 216 | 553214 | | 6006 000 215 | 551071 |
| | OE = | KYB = | | | | | | | | | | | | | | | | | | |
| | 5005 387 175 5000 388 797 | 553213 | | | | | | | | | | | | | | | | | | |
| | 7700 748 642 6006 000 216 | 553214 | | | | | | | | | | | | | | | | | | |
| | 6006 000 215 | 551071 | | | | | | | | | | | | | | | | | | |
| Master II | | | | | | | | | | | | | | | | | | | | |
| (JD, FD) (ED) | 9.97 - 1.10 | | 344306 | | | | 344307 | | | | | | | | | | | | | |
| Master III | | | | | | | | | | | | | | | | | | | | |
| (JV, FV, EV, HV, UV) 2.3 dCi | 2.10 - | | 335835 | | | | 345702 | | | | | | | | | | | | | |
| | | | 910278 SM1019 | | | | | | | | | | | | | | | | | |
| (FV, EV, HV, UV) 2.3 dCi = | 2.10 - | | 335835 | | | | 345703 | | | | | | | | | | | | | |
| | | | 910278 SM1019 | | | | | | | | | | | | | | | | | |
| (FV, EV, HV, UV) 2.3 dCi = | 2.10 - | | 335837 | | | | 345704 | | | | | | | | | | | | | |
| | | | 910278 SM1019 | | | | | | | | | | | | | | | | | |
| Maxity | | | | | | | | | | | | | | | | | | | | |
| 2.5 TDCi (81 kW) | 3.07 - | | 444322 | | | | 443466 | | | | | | | | | | | | | |
| 2.5 TDCi (96 kW) | 3.07 - | | 444322 | | | | 443467 | | | | | | | | | | | | | |
| R 5 (Super 5) Express, Rapide, Extra | | | | | | | | | | | | | | | | | | | | |
| (F 40 Series) Exc. Cu + () | 10.85 - 10.96 | 633806 ¹⁾ | 333806 ¹⁾ | | | 441064 ³⁾ | 341115 ³⁾ | | | | | | | | | | | | | |
| | | | 912020 SM1500 | | | | | | | | | | | | | | | | | |
| Cu + () | (F 40 Series) 10.85 - 10.96 | 633806 ¹⁾ | 333806 ¹⁾ | | | | | 551077 ⁴⁾ | | | | | | | | | | | | |
| | | | SM1500 | | | | | | | | | | | | | | | | | |
| (F 40 Series) Exc. Cu + () | 10.96 - | 633847 ²⁾ | 333847 ²⁾ | | | 441064 ³⁾ | 341115 ³⁾ | | | | | | | | | | | | | |
| | | | SM1500 | | | | | | | | | | | | | | | | | |
| Cu + () | (F 40 Series) 10.96 - | 633847 ²⁾ | 333847 ²⁾ | | | | | 551077 ⁴⁾ | | | | | | | | | | | | |
| | | | SM1500 | | | | | | | | | | | | | | | | | |
| 1) 633806 $\phi 12\text{ mm}$ 2) 633847 $\phi 14\text{ mm}$ 3) 34 mm 4) 40 mm | | | | | | | | | | | | | | | | | | | | |



| MODEL FAHRZEUG MODELE | YEAR JAHR ANNEE | FRONT/VORNE/AVANT | | | | REAR/HINTEN/ARRIERE | | | |
|-----------------------------|-----------------------|-----------------------------|-----------------------------|--------------------------------|--|-----------------------------|-----------------------------|--------------------------------|--|
| | | PREMIUM Twin-tube Oil | EXCEL-G Twin-tube Gas | GAS-A-JUST Mono-tube Gas | | PREMIUM Twin-tube Oil | EXCEL-G Twin-tube Gas | GAS-A-JUST Mono-tube Gas | |

Renault Commercial (F)

Trafic T Series (2WD)

| | | | | | | | | | |
|---|-------------|----------------------|--|--|--|--|--|--|--|
| Exc. (T1**) (T3**) (T4**) High-Roof | 81 - 2.89 | 635909 L 635908 R | | | | 444155 | | | |
| (T1**, T4**) | 81 - 2.89 | | | | | 444156 | | | |
| High-Roof (T42*, T44*, T46*, T4C*) → 25720 | 81 - 12.82 | 635909 L 635908 R | | | | 444155 | | | |
| High-Roof (T42*, T44*, T46*, T4C*) 25721 → | 1.83 - 2.89 | | | | | 444155 | | | |
| (T2**, T5**, T6**, T7**, T9**) (TA**, TB**, TE**) | 81 - 2.89 | 635909 L 635908 R | | | | 444156 | | | |
| (T1**, T2**, T3**, T4**) (TG**, TH**, TJ**) | 3.89 - 8.01 | 635909 L 635908 R | | | | 444155 | | | |
| (T7**) (TB**, TH**, TM**) | 3.89 - 8.01 | 635909 L 635908 R | | | | 444156 | | | |
| (T5**) | 3.89 - 8.01 | 635909 L 635908 R | | | | 444155 ¹⁾ 444156 ²⁾ | | | |
| (TC**) | 3.89 - 8.01 | 635909 L 635908 R | | | | | | | |

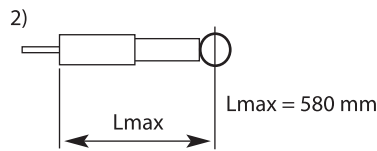
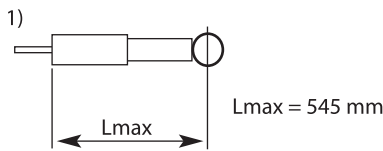

Trafic P Series (2WD)

| | | | | | | | | | |
|--------------------------------------|-----------------------------------|--|--|--|--|--|--|--|--|
| → 3373 (P3**) | 81 - 82 | 635909 L ¹⁾ 635908 R ²⁾ | | | | | | | |
| 3374 → (P3**) | 82 - 2.89 | 635909 L ¹⁾ 635908 R ²⁾ | | | | | | | |
| → 224 (P5**) → 105 (P64*) | 81 - 82 81 - 82 | 635909 L 635908 R | | | | | | | |
| 225 → (P5**) 106 → (P64*) (P8**) | 82 - 8.01 82 - 8.01 81 - 89 | 635909 L 635908 R | | | | | | | |

1) OE = 7700 718 591 2) OE = 7700 718 592

Trafic II

| | | | | | | | | | |
|---|--------|--------|--------|--|--|--|--------|--|--|
| 1.9 dCi, 2.0, 2.0 dCi, (EL, FL, JL) 2.5 dCi, 2.5 dTi | 3.01 - | | 335803 | | | | 344803 | | |
| | | 910039 | SM1511 | | | | | | |

Trafic III

| | | | | | | | | | |
|-----------------|--------|--------|--------|--|--|--|--------|--|--|
| (JG_, FG_, EG_) | 5.14 - | | 335803 | | | | 344803 | | |
| | | 910039 | SM1511 | | | | | | |



| MODEL FAHRZEUG MODELE | YEAR JAHR ANNEE | FRONT/VORNE/AVANT | | | | REAR/HINTEN/ARRIERE | | | | |
|---|-----------------------|---|-----------------------------|--------------------------------|--|-----------------------------|-----------------------------|--------------------------------|--|--|
| | | PREMIUM Twin-tube Oil | EXCEL-G Twin-tube Gas | GAS-A-JUST Mono-tube Gas | | PREMIUM Twin-tube Oil | EXCEL-G Twin-tube Gas | GAS-A-JUST Mono-tube Gas | | |
| Rover (GB) | | | | | | | | | | |
| 25 | | | | | | | | | | |
| Exc. Sport sus., ZR, Streetwise | (RF) | 11.99 - | | 334156 | | | 341208 | | | |
| 45, ZS | | | | | | | | | | |
| Exc. 2.5, ZS | (RT) | 1.00 - | | 341234 L 341233 R | | | 341131 | | | |
| | | | | | | | | | | |
| 2.5 ZS | (RT) | 1.00 - | | | | | 341131 | | | |
| 75, RJ | | | | | | | | | | |
| 1.8 1.8 Turbo 2.0 V6 2.5 V6 (129 kW) 2.5 V6 (130 kW) 2.0 CDT 2.0 CDTi | | 2.99 - 5.03 - 2.99 - 2.99 - 10.01 10.01 - 2.99 - 2.03 - | | 334963 L 334962 R | | | 343475 | | | |
| 100 Series | | | | | | | | | | |
| 114 | (XP) | 90 - | | 342016 | | | | | | |
| 200 Series | | | | | | | | | | |
| 213, 216 series | (SD 3) | 84 - 89 | | | | | 441054 | 341050 | | |
| 214 216 Exc. 216 GTi | (XW) | 86 - 96 | 634041 L ▼ 634040 R ▼ | 334069 L 334068 R | | | 441082 ▼ | 341131 | | |
| | | | | | | | | | | |
| 216 GTi 220 Incl. 220 GTi | (XW) | 86 - 96 | | 334069 L 334068 R | | | | 341131 | | |
| | | | | | | | | | | |
| 218 Diesel (1.9 D) 218 Turbo Diesel (1.7 TD) | (XW) | 86 - 96 | 634067 L ▼ 634066 R ▼ | 334104 L ▼ 334103 R ▼ | | | 441082 ▼ | 341131 | | |
| | | | | | | | | | | |
| 211, 214, 216, 218, 220 D Incl. Si, SD, SDi | (RF) | 96 - 3.00 | | 334156 | | | | 341208 | | |
| | | | | | | | | | | |
| 200 Vi | (RF) | 96 - 3.00 | | | | | | 341208 | | |
| | | | | | | | | | | |
| 200 Series | | | | | | | | | | |
| Incl. 220 Turbo → 911247 | (XW) | 89 - 2.96 | | 334069 L 334068 R | | | | 341131 | | |
| | | | | | | | | | | |
| Incl. 220 Turbo 911248 → | (XW) | 2.96 - | | 334156 | | | | | | |
| | | | | | | | | | | |
| 200 Series | | | | | | | | | | |
| 214 → 911247 | (XW) | 92 - 2.96 | 634041 L ▼ 634040 R ▼ | 334069 L 334068 R | | | 441082 ▼ | 341131 | | |
| | | | | | | | | | | |



Saab

| MODEL FAHRZEUG MODELE | YEAR JAHR ANNEE | FRONT/VORNE/AVANT | | | REAR/HINTEN/ARRIERE | |
|---|-----------------------------------|-----------------------------|-----------------------------|--------------------------------|--------------------------------|-----------------------------|
| | | PREMIUM Twin-tube Oil | EXCEL-G Twin-tube Gas | GAS-A-JUST Mono-tube Gas | | PREMIUM Twin-tube Oil |
| Rover (GB) | | | | | | |
| 200 Series | | | | | | |
| 216 → 911247 | (XW) 92 - 2.96 | 634067 L▼ 634066 R▼ | 334104 L▼ 334103 R▼ | | 441082▼ 341131 | |
| 911248 → | (XW) 3.96 - | | 334156 | | 441082▼ 341131 | |
| 400 Series | | | | | | |
| 414, 416 | (XW) 89 - 95 | 634041 L▼ 634040 R▼ | 334069 L 334068 R | | 441082▼ 341131 | |
| 418 Diesel, 418 Turbo Diesel 420 | (XW) 89 - 95 | 634067 L▼ 634066 R▼ | 334104 L▼ 334103 R▼ | | 441082▼ 341131 | |
| 414 416 420 420 D, TD, SD | (RT) 5.95 - 3.00 | | 341219 L 341218 R | | 341131 | |
| 400 Series | | | | | | |
| 414, 416 → 911247 | (XW) 94 - 2.96 | 634041 L▼ 634040 R▼ | 334069 L 334068 R | | 441082▼ 341131 | |
| 418 Diesel, 418 Turbo Diesel 420 → 911247 | (XW) 94 - 2.96 | 634067 L▼ 634066 R▼ | 334104 L▼ 334103 R▼ | | 441082▼ 341131 | |
| 911248 → | (XW) 3.96 - 3.00 | | 334156 | | 441082▼ 341131 | |
| 600 Series | | | | | | |
| | (RH) 93 - 2.99 | | 341172 L 341171 R | | 341173 | |
| 800 Series | | | | | | |
| | (RS) 11.91 - 2.99 | 441097▼ | 341156 | | 634065 L▼ 634064 R▼ Exc. | |
| MGF | | | | | | |
| 1.8i 1.8iVVC | (RD) 3.95 - 3.02 | | 343416 | | 343417 | |
| Saab (S) | | | | | | |
| 9-3 (YS3D) W-2 050001/W-7 050001 → | | | | | | |
| | (YS3D) 4.98 - 8.02 4.98 - 5.03 | | 366012 | | 343270 | |
| | | | | | | |



| MODEL FAHRZEUG MODELE | YEAR JAHR ANNEE | FRONT/VORNE/AVANT | | | | REAR/HINTEN/ARRIERE | | | |
|---|-----------------------|-----------------------------|-----------------------------|--------------------------------|--|-----------------------------|-----------------------------|--------------------------------|--|
| | | PREMIUM Twin-tube Oil | EXCEL-G Twin-tube Gas | GAS-A-JUST Mono-tube Gas | | PREMIUM Twin-tube Oil | EXCEL-G Twin-tube Gas | GAS-A-JUST Mono-tube Gas | |
| Saab (S) | | | | | | | | | |
| 9-3 (YS3F) | | | | | | | | | |
| 1.8 i, 1.8 T, 2.0 T, 1.9 TiD 2.0 T XWD, 2.2 TiD Incl. Sport sus. Exc. BioPower | (YS3F) | 7.03 - | | 334668 L 334669 R | | | 343601▼ 349007 | | |
| 1.8 t BioPower, 2.0 t BioPower | (YS3F) | 1.07 - | | | | | | | |
| 1) Incl. 2.8 Turbo V6 | | | | | | | | | |
| 9-5 (YS3E) | | | | | | | | | |
| Exc. Sport sus. | (YS3E) | 9.97 - 8.01 10.98 - 8.01 | | 335921 | | | 341847 | | |
| | | | 910162 | SM5336 | | 910163 | | | |
| Exc. Sport sus. | (YS3E) | 9.01 - 9.05 | | | | | 341847 | | |
| | | | 910162 | SM5336 | | 910163 | | | |
| 1.9 TiD 2.0 t, 2.0 t BioPower 2.3 Turbo, 2.3 t BioPower Exc. Sport sus. | (YS3E) | 1.06 - | | | | | 341847 | | |
| | | | 910162 | SM5336 | | 910163 | | | |
| 9-5 (YS3G) | | | | | | | | | |
| 1.6 T, 2.0 T (162 kW), 2.0 T BioPower Exc. Sport sus., , , | (YS3G) | 5.10 - | | 339378 L 339377 R | | | | | |
| 2.0 T, 2.0 T BioPower ⊕ Sport sus., Exc. , | (YS3G) | 5.10 - | | 339380 L 339379 R | | | 349202▼ | | |
| 2.0 T XWD, 2.0 T BioPower XWD, 2.8 T V6 XWD ⊕ , Sport sus. Exc. | (YS3G) | 5.10 - | | | | | 349197▼ | | |
| 1.6 T, 2.0 TiD, 2.0 TTiD Incl. , Sport sus. Exc. , | (YS3G) | 5.10 - | | | | | 349196 | | |
| 2.0 TTiD ⊕ Sport sus., Exc. | (YS3G) | 5.10 - | | 339421 L 339420 R | | | 349196 | | |
| 90 | | | | | | | | | |
| | | 84 - 88 | | 343008 | | | 343024 | | |
| 95, 96, GT 750 | | | | | | | | | |
| 95, 96, GT 750 | | 60 - 79 | 443033 | 343083 | | 443034 | | | |



Seat

| MODEL FAHRZEUG MODELE | YEAR JAHR ANNEE | FRONT/VORNE/AVANT | | | | REAR/HINTEN/ARRIERE | | | |
|--|-----------------------|-----------------------------|-----------------------------|--------------------------------|--------|-----------------------------|-----------------------------|--------------------------------|--------|
| | | PREMIUM Twin-tube Oil | EXCEL-G Twin-tube Gas | GAS-A-JUST Mono-tube Gas | | PREMIUM Twin-tube Oil | EXCEL-G Twin-tube Gas | GAS-A-JUST Mono-tube Gas | |
| Saab (S) | | | | | | | | | |
| 95, 96, GT 750 | | | | | | | | | |
| 95 | 60 - 78 | 443033 | 343083 | | ○ ○ | | | | |
| 99 | | | | | | | | | |
| Exc. Turbo | 68 - 4.78 | | 343008 | | ○ ○ | | | | ⊥ ⊥ |
| Turbo | 77 - 4.78 | | 343008 | | ○ ○ | | | | ⊥ ⊥ |
| Exc. Turbo | 5.78 - 84 | | 343008 | | ○ ○ | | 343024 | | ⊥ ⊥ |
| Turbo | 5.78 - 84 | | 343008 | | ○ ○ | | 343024 | | ⊥ ⊥ |
| 900 | | | | | | | | | |
| Exc. Turbo | 5.78 - 93 | 443037▼ | 343023 | | ⊥ ○ | | 343024 | | ⊥ ⊥ |
| Turbo | 5.78 - 93 | | 343023 | | ⊥ ○ | | 343024 | | ⊥ ⊥ |
| 2.0, 2.0 Turbo, 2.3, 2.5 V6 | 9.93 - 98 | | 366010 | | ⊥ | | 343270 | | ⊥ ⊥ |
| 2.0, 2.0 Turbo, 2.3, 2.5 V6 | 9.93 - 98 | | 366009 | | ⊥ | | 343270 | | ⊥ ⊥ |
| 9000 | | | | | | | | | |
| H1015470 → H8000556 → Exc. Turbo, CS | 87 - | | 334029 | | ⊥ ⊥ | | | 553187 Exc. | ⊥ ⊥ |
| CS Exc. Sport | 92 - | | 334029 | | ⊥ ⊥ | | | 553187 Exc. | ⊥ ⊥ |
| Santana (E) → Suzuki (J) | | | | | | | | | |
| Seat (E) | | | | | | | | | |
| 124, 1430 | | | | | | | | | |
| | 67 - | 443007 | 343072 | | ⊥ ⊥ | | 343017 | | ⊥ ⊥ |
| | 67 - 80 | 443007 | 343072 | | ⊥ ⊥ | 443123 | 343098 | 553005▼ | ○ ⊥ |
| 131 | | | | | | | | | |
| Mirafiori | 74 - 78 | | | | ⊥ ⊥ | | 343017 | | ⊥ ⊥ |
| Super Mirafiori | 77 - | | | | ⊥ ⊥ | | 343017 | | ⊥ ⊥ |



| MODEL FAHRZEUG MODELE | YEAR JAHR ANNEE | FRONT/VORNE/AVANT | | | | REAR/HINTEN/ARRIERE | | | | | | | | | |
|--|-----------------------|-----------------------------|--|--|--|-----------------------------|--|--------------------------------|--|--|------------|----------------------------|--------|---------|--------|
| | | PREMIUM Twin-tube Oil | EXCEL-G Twin-tube Gas | GAS-A-JUST Mono-tube Gas | | PREMIUM Twin-tube Oil | EXCEL-G Twin-tube Gas | GAS-A-JUST Mono-tube Gas | | | | | | | |
| Seat (E) | | | | | | | | | | | | | | | |
| 132 | | | | | | | | | | | | | | | |
| 1600, 1800, 2000 | 72 - 82 | 443013 | | | | | | | | | | | | | |
| Alhambra | | | | | | | | | | | | | | | |
| Exc. | (7MS/7V8/7V9) | 3.96 - 3.10 | | 334947 | | | 343319 | 553244 | | | | | | | |
| | | | 910090 | SM1704 | | | | | | | | | | | |
| | (7MS/7V8/7V9) | 3.96 - 3.10 | | | | | 343319 | 553244 | | | | | | | |
| | | | | SM1704 | | | | | | | | | | | |
| Incl. Sport sus. | (710) | 6.10 - | | 335808 325700 | | | 344459 354006 | | | | | | | | |
| | | | 910004 ¹⁾ 910059 ²⁾ | | | | 910056 | SM9709 | | | | | | | |
| 1) Exc. Sport sus. 2) Sport sus. | | | | | | | | | | | | | | | |
| Altea, Altea XL | | | | | | | | | | | | | | | |
| | (5P) | 3.04 - | | 334834 ¹⁾ 324703 ¹⁾ | | | 344459 354006 | | | | | | | | |
| Exc. Sport sus., | | | 910057 | SM1714 | | | 910058 | SM9707 | | | | | | | |
| | (5P) | 3.04 - | | 335808 ²⁾ 325700 ²⁾ | | | 344459 354006 | | | | | | | | |
| Exc. Sport sus., | | | 910057 | SM1714 | | | 910058 | SM9707 | | | | | | | |
| 1) 2) | | | | | | | | | | | | | | | |
| Arona | | | | | | | | | | | | | | | |
| Exc. | (KJ7) | 7.17 - 6.19 | | 3348090 | | | 3430079◇ | | | | | | | | |
| Exc. | (KJ7) | 7.19 - | | 3348090 | | | 3430074 | | | | | | | | |
| Arosa | | | | | | | | | | | | | | | |
| 1.0, 1.4, 1.7 SDI, 1.4 TDi Exc. Sport sus. | (6H) | 97 - 6.04 | 633276 | 333712 324025 | | | 343309 | | | | | | | | |
| | | | 915401 | SM1707 | | | 910280 ¹⁾ 910281 ¹⁾ | SM9939 | | | | | | | |
| 1) <table border="1"> <tr> <td></td> <td>KYB</td> </tr> <tr> <td>1.0, 1.4, 1.4 TDi, 1.7 SDi</td> <td> 910280</td> </tr> <tr> <td>1.4 16V</td> <td> 910281</td> </tr> </table> | | | | | | | | | | | KYB | 1.0, 1.4, 1.4 TDi, 1.7 SDi | 910280 | 1.4 16V | 910281 |
| | KYB | | | | | | | | | | | | | | |
| 1.0, 1.4, 1.4 TDi, 1.7 SDi | 910280 | | | | | | | | | | | | | | |
| 1.4 16V | 910281 | | | | | | | | | | | | | | |



| MODEL FAHRZEUG MODELE | YEAR JAHR ANNEE | FRONT/VORNE/AVANT | | | | REAR/HINTEN/ARRIERE | | | |
|--|-----------------------|-----------------------------|--|--------------------------------|--|-----------------------------|-----------------------------|--------------------------------|--|
| | | PREMIUM Twin-tube Oil | EXCEL-G Twin-tube Gas | GAS-A-JUST Mono-tube Gas | | PREMIUM Twin-tube Oil | EXCEL-G Twin-tube Gas | GAS-A-JUST Mono-tube Gas | |
| Seat (E) | | | | | | | | | |
| Ateca | | | | | | | | | |
| (2WD) 1.0 TSi (85 kW), 1.4 TSi 1.6 TDi, 2.0 TDi (81 kW, 110 kW) | (KH7) | 4.16 - | | | | | 3448027 | | |
| | | | 910255 SM1051 | | | | | | |
| (2WD) 1.0 TSi (81 kW), 1.5 TSi Exc. | (KH7) | 7.18 - | | | | | 3448027 | | |
| | | | 910255 SM1051 | | | | | | |
| (2WD) 1.0 TSi (81 kW), 1.5 TSi Multilink axle, Exc. | (KH7) | 7.18 - | | | | | 3448023 | | |
| | | | 910255 SM1051 | | | | | | |
| (4WD) Exc. | (KH7) | 4.16 - | | | | | 3448023 | | |
| | | | 910255 SM1051 | | | | | | |
| Cordoba Vario | | | | | | | | | |
| 1.4, 1.6 1.9 SDI (47 kW, 50 kW) | (6K) | 97 - 8.02 | 633276 | 333712 324025 | | 443296 ¹⁾ | 343297 ¹⁾ | | |
| | | | 915401 SM1704 ²⁾ SM1713 ³⁾ | | | 915419 SM9700 | | | |
| 1.9 TDI (66 kW, 81 kW) | (6K) | 97 - 8.02 | 634810 | 334810 324025 | | 443296 ¹⁾ | 343297 ¹⁾ | | |
| | | | 910088 SM1704 ²⁾ SM1713 ³⁾ | | | 915419 SM9700 | | | |
| 1) OE, (SG-701) 2) 97-5.99 3) 6.99-8.02 | | | | | | | | | |
| Exeo | | | | | | | | | |
| 1.6, 1.8 T, 1.8 TSi, 1.8 TFSI 2.0 TFSI, 2.0 TDI Exc. , Sport sus. | (3R2, 3R5) | 12.08 - | | 341845 | | | 344807 | | |
| | | | 910116 | | | 910227 SM9918 | | | |
| 1.6, 1.8 T, 1.8 TSi, 1.8 TFSI 2.0 TFSI, 2.0 TDI Sport sus. | (3R2, 3R5) | 12.08 - | | | | | 344808 | | |
| | | | | | | 910227 SM9918 | | | |
| Ibiza, Cordoba Exc. Cupra | | | | | | | | | |
| Ibiza 1.2, 1.5, 1.7 D, 1.7 | (021A) | 7.84 - 7.86 | | | | 633814▼ | 333814▼ | | |
| | | | | SM1804 | | | | | |
| Ibiza 1.2, 1.5, 1.7 D, 1.7 Junior SXi | (021A) | 8.86 - 8.89 1.86 - 8.89 | 633813 | | | 633815 | 333815 | | |
| | | | 915401 SM1705 | | | | | | |
| Ibiza 0.9, 1.2, 1.5, 1.7 D Junior SXi | (021A) | 9.89 - 93 | 633840▼ | 333840 | | 633815 | 333815 | | |
| | | | 915401 SM1705 | | | | | | |



| MODEL FAHRZEUG MODELE | YEAR JAHR ANNEE | FRONT/VORNE/AVANT | | | REAR/HINTEN/ARRIERE |
|--|-----------------------|-----------------------------|-----------------------------|---|---|
| | | PREMIUM Twin-tube Oil | EXCEL-G Twin-tube Gas | GAS-A-JUST Mono-tube Gas | |
| Seat (E) | | | | | |
| Ibiza, Cordoba Exc. Cupra | | | | | |
| 1.0, 1.0 i, 1.3, 1.4 1.9 SDI (6K, 6K/C) | 93 - 8.99 | 633276 | 333712 324025 | SM1701▼ SM1700 ²⁾ SM1704 ²⁾ | 443801 ¹⁾ 343274 ¹⁾ 353021 ¹⁾ SM9700 |
| 1.6, 1.8 1.9 D, 1.9 TD (47 kW, 55 kW) Exc. 1.8 16V, 1.9 TDI (6K, 6K/C) | 93 - 8.99 | 633276 | 333712 324025 | SM1701▼ SM1700 ²⁾ SM1704 ²⁾ | 443801 ¹⁾ 343274 ¹⁾ 353021 ¹⁾ SM9700 |
| 1.9 TDI (66 kW, 81 kW) (6K, 6K/C) | 96 - 8.99 | 634810 | 334810 324025 | SM1701▼ SM1700 ²⁾ SM1704 ²⁾ | 443801 ¹⁾ 343274 ¹⁾ 353021 ¹⁾ SM9700 |
| 1.8 16V 2.0 GTi, 2.0 GTi 16V, 2.0 SX 16V (6K, 6K/C) | 93 - 8.99 | 634810 | 334810 324025 | SM1701▼ SM1700 ²⁾ SM1704 ²⁾ | 343283 ¹⁾ ▼ SM9700 |
| 1.0, 1.4, 1.6, 1.9 D Exc. Sport sus. (6K, 6K/C) | 8.99 - 2.02 | 633276 | 333712 324025 | SM1713 | 443296 ¹⁾ 343297 ¹⁾ SM9700 |

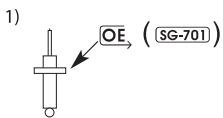

2)

| Model | Year | KYB |
|---------|-------------------------|--------------------------|
| Cordoba | 1.4 i | ABD 11.93 - 10.95 SM1700 |
| | | AEX 9.95 - 6.96 SM1704 |
| | | ABD 10.95 - 11.95 SM1700 |
| | 1.6 i | ABU 9.93 - 8.94 SM1700 |
| | | 1F 11.93 - 10.95 SM1700 |
| | | AFT 9.95 - 6.96 SM1704 |
| | 1.8 i | 1F 10.95 - 6.96 SM1704 |
| | | ABS 9.93 - 8.94 SM1700 |
| | | ADL 2.94 - 6.96 SM1704 |
| | | ADL 2.94 - 3.94 SM1700 |
| | | ADZ 7.94 - 10.95 SM1700 |
| | | ACC 3.95 - 10.95 SM1700 |
| | | ACC 10.95 - 6.96 SM1704 |
| | ADZ 10.95 - 6.96 SM1704 | |
| | 1.9 D | 9.93 - 10.95 SM1700 |
| | | 10.95 - 6.96 SM1704 |
| | 1.9 SDI | 9.95 - 6.96 SM1704 |
| | 1.9 TD | 9.93 - 10.95 SM1700 |
| | 2.0 i | 9.93 - 2.94 SM1700 |
| | | 2.94 - 6.96 SM1704 |
| | 7.96 - 8.99 SM1704 | |
| | 8.99 - 2.02 SM1713 | |
| | 3.02 - SM1713 | |

| Model | Year | KYB |
|----------------|-------------------------|-----|
| 1.05 i | 2.93 - 10.95 SM1700 | |
| | 10.95 - 6.96 SM1704 | |
| 1.3 i | 2.93 - 7.94 SM1700 | |
| 1.6 i | 2.93 - 10.95 SM1700 | |
| | 10.95 - 6.96 SM1704 | |
| 1.9 D / 1.9 TD | 2.93 - 10.95 SM1700 | |
| | 10.95 - 6.96 SM1704 | |
| 1.4 i | ABD 9.93 - 10.95 SM1700 | |
| | AEX 7.95 - 6.96 SM1704 | |
| | ABD 10.95 - 6.96 SM1704 | |
| 1.8 i | ABS 2.93 - 10.95 SM1700 | |
| | ADL 2.94 - 6.96 SM1704 | |
| | ACC 7.94 - 3.95 SM1704 | |
| | ADZ 7.94 - 10.95 SM1700 | |
| | ABS 10.95 - 6.96 SM1704 | |
| | ADZ 10.95 - 6.96 SM1704 | |
| 1.9 SDI | 9.95 - 6.96 SM1704 | |
| 2.0 i | 9.93 - 2.94 SM1700 | |
| | 2.94 - 6.96 SM1704 | |
| | 7.96 - 8.99 SM1704 | |
| | 8.99 - 2.02 SM1713 | |
| | 3.02 - SM1713 | |



| MODEL FAHRZEUG MODELE | YEAR JAHR ANNEE | FRONT/VORNE/AVANT | | | | REAR/HINTEN/ARRIERE | | | |
|--|-----------------------|-----------------------------|-----------------------------|--------------------------------|--|-----------------------------|-----------------------------|--|--|
| | | PREMIUM Twin-tube Oil | EXCEL-G Twin-tube Gas | GAS-A-JUST Mono-tube Gas | | PREMIUM Twin-tube Oil | EXCEL-G Twin-tube Gas | GAS-A-JUST Mono-tube Gas | |
| Seat (E) | | | | | | | | | |
| Ibiza, Cordoba Exc. Cupra | | | | | | | | | |
| 1.8, 1.9 TD (6K, 6K/C) | 8.99 - 2.02 | 634810 | 334810 324025 | SM1713 | | 343297 ¹⁾ | 915419 | SM9700 | |
| Sport sus. (6K, 6K/C) | 8.99 - 2.02 | | 334810 324025 | SM1713 | | 343297 ¹⁾ | 915419 | SM9700 | |
| Exc. Sport sus., Cupra (6L) | 3.02 - 11.09 | | 334835 324702 | 910084 SM1713 | | 343328 353025 | 915400 | SM9703 ³⁾ SM9704 ⁴⁾ | |
| 1.8 T Cupra R, 1.9 TDI Cupra R (6L) | 1.04 - 2.08 | | | SM1713 | | | | SM9703 ³⁾ SM9704 ⁴⁾ | |
| <p>1) OE, (SG-701)</p> <p>2) Cordoba (6L2) : 1.2 (47 kW), 1.4 TDI (51 kW, 55 kW), 1.6 Sport sus., 1.9 SDI Ibiza IV (6L1) : 1.2 (44 kW), 1.6 16V, 1.9 SDI</p> <p>3) SM9703 : OE p/n = 1J0513353D</p> <p>4) SM9704 : OE p/n = 1J0513353G, 1J0513353B, 6R0513353</p> | | | | | | | | | |
| Ibiza IV | | | | | | | | | |
| 1.0, 1.0 TSi, 1.2, 1.2 LPG, 1.2 TSi (6J_, 6P_) 1.4, 1.4 LPG, 1.6, 1.6 LPG 1.4 TDi, 1.6 TDi, 1.9 TDi Exc. Cupra, Sport sus. | 3.08 - 6.17 | | 339763 | 910154 SM1708 | | 343328 353025 | 915400 | SM9703 ²⁾ SM9704 ³⁾ | |
| 1.0, 1.0 TSi, 1.2, 1.2 LPG, 1.2 TSi (6J_, 6P_) 1.4, 1.4 LPG, 1.6, 1.6 LPG 1.4 TDi, 1.6 TDi, 1.9 TDi Sport sus. Exc. Cupra | 3.08 - 6.17 | | 339741 | 910154 SM1708 | | 343328 353025 | 915400 | SM9703 ²⁾ SM9704 ³⁾ | |
| 1.4 TSi, 2.0 Exc. Cupra, Sport sus. (6J_, 6P_) | 10.08 - 6.17 | | 339741 | 910154 SM1708 | | 343328 353025 | 915400 | SM9703 ²⁾ SM9704 ³⁾ | |
| 1.4 TSi, 2.0 Sport sus. Exc. Cupra (6J_, 6P_) | 10.08 - 6.17 | | 3348020 | 910154 SM1708 | | 343328 353025 | 915400 | SM9703 ²⁾ SM9704 ³⁾ | |
| 2.0 TDi Incl. Sport sus. (6J_, 6P_) | 1.10 - 5.15 | | 3348020 | 910154 SM1708 | | 343328 353025 | 915400 | SM9703 ²⁾ SM9704 ³⁾ | |
| <p>1) Exc. OE p/n 6R0513025K, 6R0513025P 2) SM9703 : OE p/n = 1J0513353D 3) SM9704 : OE p/n = 1J0513353G, 1J0513353B, 6R0513353</p> | | | | | | | | | |



| MODEL FAHRZEUG MODELE | YEAR JAHR ANNEE | FRONT/VORNE/AVANT | | | | REAR/HINTEN/ARRIERE | | | |
|--|-----------------------|-----------------------------|-----------------------------|--------------------------------|--|-----------------------------|--|--------------------------------|--|
| | | PREMIUM Twin-tube Oil | EXCEL-G Twin-tube Gas | GAS-A-JUST Mono-tube Gas | | PREMIUM Twin-tube Oil | EXCEL-G Twin-tube Gas | GAS-A-JUST Mono-tube Gas | |
| Seat (E) | | | | | | | | | |
| Ibiza IV | | | | | | | | | |
| 1.4 TSI Cupra Incl. Sport sus. (6J_, 6P_) | 6.09 - 5.15 | | 3348020 | | | | | 552700 ¹⁾ | |
| | | 910154 | SM1708 | | | 915400 | SM9703 ²⁾ SM9704 ³⁾ | | |
| 1.8 TSI Cupra Incl. Sport sus. (6J_, 6P_) | 11.15 - 12.16 | | 3348020 | | | | | | |
| | | 910154 | SM1708 | | | 915400 | SM9703 ²⁾ SM9704 ³⁾ | | |
| 1) Exc. OE p/n 6R0513025K, 6R0513025P 2) SM9703 : OE p/n = 1J0513353D 3) SM9704 : OE p/n = 1J0513353G, 1J0513353B, 6R0513353 | | | | | | | | | |
| Ibiza V | | | | | | | | | |
| Exc. Sports sus., | (KJ1) 1.17 - | | 3348074 | | | | | 3430079 ¹⁾ | |
| | | | SM1051 | | | | | | |
| Sports sus. Exc. | (KJ1) 1.17 - | | 3348074 | | | | | | |
| | | | SM1051 | | | | | | |
| Exc. Sport sus., | (KJ1) 1.17 - | | 3348074 | | | | | 3430074 | |
| | | | SM1051 | | | | | | |
| 1) | | | | | | | | | |
| Leon (1M1) | | | | | | | | | |
| 1.4, 1.6 Exc. Sport sus., , Cupra (1M1) | 10.99 - 9.05 | 633713 | 333713 324016 | | | | | 343348 553206 | |
| | | 915415 | SM1708 | | | 915400 | SM9703 ¹⁾ SM9704 ²⁾ | | |
| 1.8, 1.8 T, 1.9 SDI, 1.9 TDI Exc. Sport sus., , Cupra (1M1) | 10.99 - 9.05 | 634812 | 334812 324016 | | | | | 343348 553206 | |
| | | 915415 | SM1708 | | | 915400 | SM9703 ¹⁾ SM9704 ²⁾ | | |
| Sport sus. Exc. Cupra (1M1) | 10.99 - 9.05 | | 334812 324016 | | | | | 553206 | |
| | | 915415 | SM1708 | | | 915400 | SM9703 ¹⁾ SM9704 ²⁾ | | |
| Exc. Cupra (1M1) | 10.99 - 9.05 | 634812 | 334812 | | | | | | |
| | | 915415 | SM1708 | | | | | | |
| 1.8 T Cupra R (1M1) | 2.02 - 6.06 | | | | | | | | |
| | | | SM1708 | | | | SM9703 ¹⁾ SM9704 ²⁾ | | |
| 1) SM9703 : OE p/n = 1J0513353D 2) SM9704 : OE p/n = 1J0513353G | | | | | | | | | |



| MODEL FAHRZEUG MODELE | YEAR JAHR ANNEE | FRONT/VORNE/AVANT | | | REAR/HINTEN/ARRIERE | | |
|-----------------------------|-----------------------|-----------------------------|-----------------------------|--------------------------------|-----------------------------|-----------------------------|--------------------------------|
| | | PREMIUM Twin-tube Oil | EXCEL-G Twin-tube Gas | GAS-A-JUST Mono-tube Gas | PREMIUM Twin-tube Oil | EXCEL-G Twin-tube Gas | GAS-A-JUST Mono-tube Gas |

Seat (E)

Leon (1M1)

| | | | | | | | | |
|--|-----------------------|--|--------|--|--|--------|--------|--|
| (4WD) 1.8 20V T 4, 1.9 TDI Syncro, 2.8 Cupra 4 | (1M1) 10.99 - 9.05 | | 334670 | | | 343310 | 553243 | |
|--|-----------------------|--|--------|--|--|--------|--------|--|

Leon (1P1)

| | | | | | | | | |
|-------------------------------|-----------------|--|--|--|--|----------------------|--|--|
| ALL Exc. Sport sus. | (1P1) 5.05 - | | 334834 ¹⁾ 335808 ²⁾ 324703 ¹⁾ 325700 ²⁾ | | | 344459 354006 | | |
| | | | | | | | | |

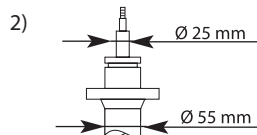
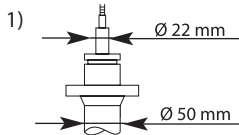

Leon (5F1) , Leon SC (5F5) , Leon ST (5F8)

| | | | | | | | | |
|--|-----------------|--|--|--|--|---|--|--|
| (2WD) ALL Incl. Sport sus., Exc. , Cupra R | (5F_) 9.12 - | | 3348039 ¹⁾ 3358015 ²⁾ | | | 3430023 ³⁾ 3448024 ⁴⁾ 3448025 ⁵⁾ | | |
| | | | | | | | | |
| | | | | | | | | |
| (4WD) 1.8 TSi, 1.6 TDi, 2.0 TDi Incl. Sport sus., Exc. | (5F_) 4.14 - | | 3348039 ¹⁾ 3358015 ²⁾ | | | 3448024 ⁴⁾ | | |
| | | | | | | | | |
| | | | | | | | | |

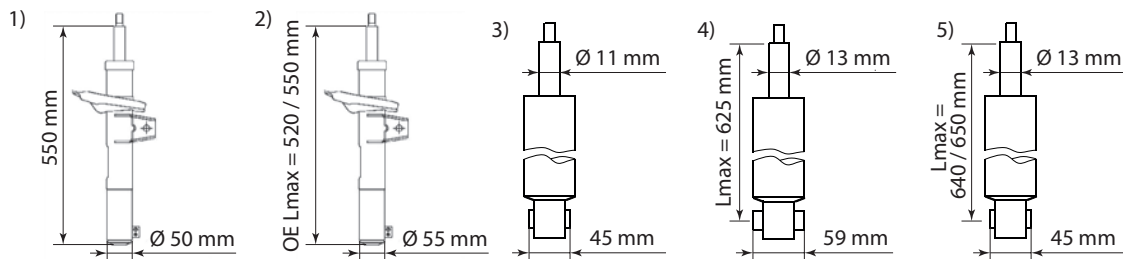

6)

| | | |
|--|----------------|---|
| | | ALL (2WD) ⊕ Normal sus. Exc. TGI, Sport sus., |
| | Multilink axle | ALL (2WD) (4WD) ⊕ Bumper height : 127 mm Exc. Cupra, Sport sus., |

7)

| | | |
|--|--|---|
| | | ALL (2WD) ⊕ Normal sus., Sport sus. Exc. CNG, TGI, |
| | | ALL (2WD) ⊕ CNG, TGI, Normal sus., |
| | | ALL (2WD) ⊕ Normal sus., Sport sus., Exc. |

Leon (KL1) , Leon Sportstourer (KL8)

| | | | | | | | | |
|--|-----------------------|--|--|--|--|--|--|--|
| ALL ⊕ Multilink axle Exc. 1.0 TSI Mild Hybrid Exc. Sport sus., | (KL1, KL8) 11.19 - | | | | | | | |
| | | | | | | | | |

1) Bumper height : 127 mm



| MODEL FAHRZEUG MODELE | YEAR JAHR ANNEE | FRONT/VORNE/AVANT | | | | REAR/HINTEN/ARRIERE | | | |
|--|--------------------------|-----------------------------|-----------------------------|--------------------------------|--|-----------------------------|-----------------------------|--------------------------------|--|
| | | PREMIUM Twin-tube Oil | EXCEL-G Twin-tube Gas | GAS-A-JUST Mono-tube Gas | | PREMIUM Twin-tube Oil | EXCEL-G Twin-tube Gas | GAS-A-JUST Mono-tube Gas | |
| Seat (E) | | | | | | | | | |
| Malaga | | | | | | | | | |
| 1.2, 1.5, 1.7 D (023A) | 5.85 - 7.86 | | | | | 633814▼ | 333814▼ | | |
| | | | | | | | | | |
| 1.2, 1.5, 1.7 D (023A) | 8.86 - 8.89 | 633813 | | | | 633815 | 333815 | | |
| | | 915401 | | | | | | | |
| 1.2, 1.5, 1.7 D (023A) | 9.89 - 12.93 | 633840▼ | 333840 | | | 633815 | 333815 | | |
| | | 915401 | | | | | | | |
| Mii | | | | | | | | | |
| Incl. Sport sus., H/D (KF1) | 10.11 - | | 3338038 | | | | 3438006 | | |
| | | 910221 ¹⁾ | | | | 910220 ¹⁾ | | | |
| 1) Exc. Sport sus. | | | | | | | | | |
| Panda, Marbella | | | | | | | | | |
| Panda Marbella | 79 - 87 - 3.89 | 633951 | 333951 | | | 441038 | 341212 | | |
| | | 910084 | | | | | | | |
| Marbella | 4.89 - | 633874 | | | | 441038 | 341212 | | |
| | | 910084 | | | | | | | |
| Ronda | | | | | | | | | |
| Exc. Crono | 84 - 6.86 | | | | | 633814▼ | 333814▼ | | |
| | | | | | | | | | |
| Crono | 84 - 6.86 | | | | | | | | |
| | | | | | | | | | |
| Strada / Ritmo | | | | | | | | | |
| 60, 65, 75, 85 Diesel | 78 - 12.83 79 - 12.83 | | | | | 633044 | | | |
| Tarraco | | | | | | | | | |
| Exc. e-Hybrid, | (KN2) 9.18 - | | 3358020 | | | | 3448024 | | |
| | | | | | | 910332 ¹⁾ | | | |
| Exc. | (KN2) 9.18 - | | 3358020 | | | | | | |
| | | | | | | 910332 ¹⁾ | | | |
| 1) 1.5 TSI ACT, 2.0 TSI 4Drive, 2.0 TDI, 2.0 TDI 4Drive | | | | | | | | | |



| MODEL FAHRZEUG MODELE | YEAR JAHR ANNEE | FRONT/VORNE/AVANT | | | | REAR/HINTEN/ARRIERE | | | |
|---|-----------------------|-----------------------------|---|--------------------------------|--|-----------------------------|---|--------------------------------|--|
| | | PREMIUM Twin-tube Oil | EXCEL-G Twin-tube Gas | GAS-A-JUST Mono-tube Gas | | PREMIUM Twin-tube Oil | EXCEL-G Twin-tube Gas | GAS-A-JUST Mono-tube Gas | |
| Seat (E) | | | | | | | | | |
| Toledo I (1L) | | | | | | | | | |
| 1.6, 1.8, 2.0 (1L) 1.9 D, 1.9 TD (47 kW, 50 kW, 55 kW) Exc. 1.8 i 16V, 2.0 i 16V, 1.9 TDI | 91 - 99 | 633276 | 333712 <u>324025</u> | | | 443800 ¹⁾ | 343191 ¹⁾ <u>353013</u> ¹⁾ | | |
| | | 915401 | SM1701▼ SM1700 ²⁾ SM1704 ²⁾ | | | 910087 | SM9700 | | |
| 1.9 TDI (66 kW, 81 kW) (1L) | 95 - 99 | 634810 | 334810 <u>324025</u> | | | 443800 ¹⁾ | 343191 ¹⁾ <u>353013</u> ¹⁾ | | |
| | | 910088 | SM1701▼ SM1700 ²⁾ SM1704 ²⁾ | | | 910087 | SM9700 | | |
| 1.8 i 16V GT (1L) 2.0 i 16V, 2.0 i 16V GT | 91 - 99 | | 334810 <u>324025</u> | | | | 343191 ¹⁾ <u>353013</u> ¹⁾ | | |
| | | 915401 | SM1701▼ SM1700 ²⁾ SM1704 ²⁾ | | | 910087 | SM9700 | | |
| <p>1) OE, (SP-001)</p> <p>2) SM1700 : 91- → ZR-054 453 SM1704 : ZR-054 454 → -99</p> | | | | | | | | | |
| Toledo II (1M2) | | | | | | | | | |
| 1.4 16V, 1.6, 1.9 SDI (1M2) Exc. Sport sus., | 99 - 7.04 | 633713 | 333713 <u>324016</u> | | | | 343348 | 553206 <u>243037</u> | |
| | | 915415 | SM1708 | | | 915400 | SM9703 ¹⁾ SM9704 ²⁾ | | |
| 1.8 20V, 2.3 V5, 1.9 TDI (1M2) Exc. Sport sus., | 99 - 7.04 | 634812 | 334812 <u>324016</u> | | | | 343348 | 553206 <u>243037</u> | |
| | | 915415 | SM1708 | | | 915400 | SM9703 ¹⁾ SM9704 ²⁾ | | |
| 1.6, 1.8 20V, 2.3 V5, 1.9 TDI (1M2) ⊕ Sport sus. | 99 - 7.04 | | 334812 <u>324016</u> | | | | | 553206 <u>243037</u> | |
| | | 915415 | SM1708 | | | 915400 | SM9703 ¹⁾ SM9704 ²⁾ | | |
| <p>1) SM9703 : OE p/n = 1J0513353D 2) SM9704 : OE p/n = 1J0513353G</p> | | | | | | | | | |



| MODEL FAHRZEUG MODELE | YEAR JAHR ANNEE | FRONT/VORNE/AVANT | | | | REAR/HINTEN/ARRIERE | | | |
|---|-----------------------|---|-----------------------------|--|--|-----------------------------|-----------------------------|--------------------------------|--------|
| | | PREMIUM Twin-tube Oil | EXCEL-G Twin-tube Gas | GAS-A-JUST Mono-tube Gas | | PREMIUM Twin-tube Oil | EXCEL-G Twin-tube Gas | GAS-A-JUST Mono-tube Gas | |
| Seat (E) | | | | | | | | | |
| Toledo III (5P2) | | | | | | | | | |
| (2WD) Exc. Sport sus., | (5P2) | 4.04 - 5.09 | | 334834 ¹⁾ 335808 ²⁾ 324703 ¹⁾ 325700 ²⁾ | | | 344459 354006 | | |
| | | | 910057 | SM1714 | | | | 910058 | SM9707 |
| 1) | | 2) | | | | | | | |
| Toledo IV (KG3) | | | | | | | | | |
| 1.2, 1.2 TSI (kW : 63, 66, 77, 81), 1.4 TDi, 1.4 TSI, 1.6, 1.6 TDi | (KG3) | 8.13 - | | | | | 344357 | | |
| | | | SM1708 | | | | | | |
| Seat Commercial (E) | | | | | | | | | |
| Inca | | | | | | | | | |
| 1.0, 1.4, 1.9 D, 1.9 SDI 1.6 i, 1.7 D | (6K) | 96 - 6.03 | 633276 | 333712 324025 | | 443287 | | 553231 | |
| | | | SM1704 | | | | | | |
| Terra, Trans | | | | | | | | | |
| Terra Trans | | 87 - 3.89 85 - | 633951 | 333951 | | 441038 | 341212 | | |
| | | | 910084 | SM1804 | | | | | |
| Terra | | 4.89 - 12.96 | 633874 | | | 441038 | 341212 | | |
| | | | 910084 | | | | | | |
| Skoda (CS) | | | | | | | | | |
| 1000, 100, 110, 105, 120 | | | | | | | | | |
| 1000, MB 100, L 110, L, LS, R 105, S, L 120, LS, GLS, LSX | | 64 - 69 70 - 78 70 - 82 10.76 - 90 | | | | 443144 | | | |
| Citigo | | | | | | | | | |
| Incl. Sport sus., H/D | | 10.11 - | | 3338038 | | | 3438006 | | |
| | | | 910221 ¹⁾ | SM1708 | | | | 910220 ¹⁾ | SM9928 |
| 1) Exc. Sport sus. | | | | | | | | | |
| Fabia | | | | | | | | | |
| Fabia I 1.0, 1.2, 1.4, 1.4 16V, 1.4 TDi, 1.9 SDi, 1.9 TDi, 2.0 Exc. , Sport sus. | (6Y) | 8.99 - 12.07 | | 334835 324702 | | | 343328 353025 | 552700 | |
| | | | 910084 | SM1713 | | | | 915400 | SM9704 |



Skoda

| MODEL FAHRZEUG MODELE | YEAR JAHR ANNEE | FRONT/VORNE/AVANT | | | | REAR/HINTEN/ARRIERE | | | |
|-----------------------------|-----------------------|-----------------------------|-----------------------------|--------------------------------|--|-----------------------------|-----------------------------|--------------------------------|--|
| | | PREMIUM Twin-tube Oil | EXCEL-G Twin-tube Gas | GAS-A-JUST Mono-tube Gas | | PREMIUM Twin-tube Oil | EXCEL-G Twin-tube Gas | GAS-A-JUST Mono-tube Gas | |

Skoda (CS)

Fabia

| | | | | | | | | | |
|---|------------|---------------|----------------|-------------------------|--|--|--|----------------------|--|
| Fabia I 1.0, 1.2, 1.4, 1.4 16V, 1.4 TDi, 1.9 SDi, 1.9 TDi, 2.0 ⊕ Exc. Sport sus. | (6Y) | 8.99 - 12.07 | | 334835 <u>324702</u> | | | 343348 | | |
| | | | 910084 SM1713 | | | | 915400 SM9704 | | |
| Fabia I 1.0, 1.2, 1.4, 1.4 16V, 1.4 TDi, 1.9 SDi, 1.9 TDi, 2.0 ⊕ Sport sus. Exc. | (6Y) | 8.99 - 12.07 | | 334835 <u>324702</u> | | | 343485 | | |
| | | | 910084 SM1713 | | | | 915400 SM9704 | | |
| Fabia II 1.2, 1.2 12V, 1.2 LPG, 1.2 TSi, 1.2 TDi, 1.4, 1.4 LPG, 1.4 TSi, 1.4 TDi, 1.6, 1.6 TDi, 1.9 TDi Exc. , Sport sus., | | 12.06 - 12.14 | | 334835 <u>324702</u> | | | 343328 <u>353025</u> | 552700 | |
| | | | 910084 SM1713 | | | | 915400 SM9704 | | |
| Fabia II 1.2, 1.2 12V, 1.2 LPG, 1.2 TSi, 1.2 TDi, 1.4, 1.4 LPG, 1.4 TSi, 1.4 TDi, 1.6, 1.6 TDi, 1.9 TDi ⊕ Exc. Sport sus., | | 12.06 - 12.14 | | 334835 <u>324702</u> | | | 343348 | | |
| | | | 910084 SM1713 | | | | 915400 SM9704 | | |
| Fabia II 1.2, 1.2 12V, 1.2 LPG, 1.2 TSi, 1.2 TDi, 1.4, 1.4 LPG, 1.4 TSi, 1.4 TDi, 1.6, 1.6 TDi, 1.9 TDi ⊕ Sport sus., Exc. | | 12.06 - 12.14 | | 334835 <u>324702</u> | | | 343485 | | |
| | | | 910084 SM1713 | | | | 915400 SM9704 | | |
| Fabia III Exc. Sport sus. | (NJ3, NJ5) | 8.14 - | | 339763 | | | 343328 ¹⁾ 343348 ²⁾ <u>353025¹⁾</u> | 552700 ¹⁾ | |
| | | | SM1708 | | | | SM9704 | | |
| Fabia III ⊕ Sport sus. | (NJ3, NJ5) | 8.14 - | | 339763 | | | 343824 | | |
| | | | SM1708 | | | | SM9704 | | |

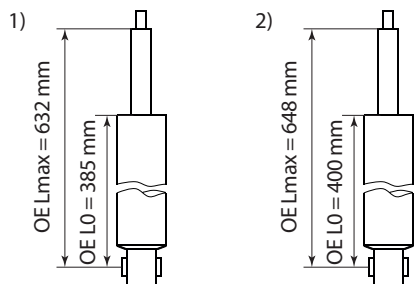

Favorit

| | | | | | | | | | |
|--|-------|---------|----------------|--------|--|--------|--------|--|--|
| | (781) | 88 - 94 | 633835 | 333835 | | 441800 | | | |
| | | | 913268 SM5505 | | | | SM9700 | | |



| MODEL FAHRZEUG MODELE | YEAR JAHR ANNEE | FRONT/VORNE/AVANT | | | Wrench icon | REAR/HINTEN/ARRIERE | | | Wrench icon |
|--|-----------------------|-----------------------------|--|--------------------------------|----------------------|--|-----------------------------|--------------------------------|-------------|
| | | PREMIUM Twin-tube Oil | EXCEL-G Twin-tube Gas | GAS-A-JUST Mono-tube Gas | | PREMIUM Twin-tube Oil | EXCEL-G Twin-tube Gas | GAS-A-JUST Mono-tube Gas | |
| Skoda (CS) | | | | | | | | | |
| Felicia | | | | | | | | | |
| (6U_) 94- 6.01 | 633835 | 333835 | | | 441800 | | | | |
| | | Exc. ABS | | | | | | | |
| | 913268 | SM5505 | | | 910087 ¹⁾ | SM9700 | | | |
| 1) | | | | | | | | | |
| Forman | | | | | | | | | |
| (785) 90- 95 | 633835 | 333835 | | | 441800 | | | | |
| | 915809▼ | SM5505 | | | 910087 | SM9700 | | | |
| | 913268 | | | | | | | | |
| Kamq | | | | | | | | | |
| (NW4) 7.19- Exc. | | | 3348074 | | | 3430079 ³⁾ ◇ | | | |
| (NW4) 7.19- Exc. | | | 3348074 ¹⁾ 3348090 ²⁾ | | | 3430074 | | | |
| <div style="display: flex; justify-content: space-around;"> <div style="text-align: center;"> <p>1)</p> <p>180 mm</p> </div> <div style="text-align: center;"> <p>2)</p> <p>170 mm</p> </div> <div style="text-align: center;"> <p>3)</p> <p>Lmax = 685 mm</p> </div> </div> | | | | | | | | | |
| Karoq | | | | | | | | | |
| (NU7) 7.17- Incl. Exc. | | | | | | 3448027 | | | |
| (NU7) 7.17- Incl. Scout Exc. | | | | | | 3448023 | | | |
| Kodiaq | | | | | | | | | |
| (NS7, NV7) 10.16- Exc. | | | 3358020 | | | | | | |
| | | | SM1051 | | 910332 | | | | |
| Octavia I (1U2) | | | | | | | | | |
| (1U2) 9.96- 12.10 1.4, 1.4 16V, 1.6, 1.9 SDi Exc. Sport sus., , RS | 633713 | 333713 324016 | | | | 343348 | 553206 | | |
| | 915415 | SM1708 | | | 915400 | SM9703 ¹⁾ SM9704 ²⁾ | 243037 | | |
| 1) SM9703 : OE p/n = 1J0513353D 2) SM9704 : OE p/n = 1J0513353B | | | | | | | | | |



Skoda

| MODEL FAHRZEUG MODELE | YEAR JAHR ANNEE | FRONT/VORNE/AVANT | | | | REAR/HINTEN/ARRIERE | | | |
|-----------------------------|-----------------------|-----------------------------|-----------------------------|--------------------------------|--|-----------------------------|-----------------------------|--------------------------------|--|
| | | PREMIUM Twin-tube Oil | EXCEL-G Twin-tube Gas | GAS-A-JUST Mono-tube Gas | | PREMIUM Twin-tube Oil | EXCEL-G Twin-tube Gas | GAS-A-JUST Mono-tube Gas | |

Skoda (CS)

Octavia I (1U2)

| | | | | | | | | |
|---|-----------------------|--------|-------------------------|--|----------------------|--|-------------------------|--|
| (2WD) 1.8, 1.8 T, 1.9 TDi, 2.0 Exc. Sport sus., , RS | (1U2) 9.96 - 12.10 | 634812 | 334812 <u>324016</u> | | | 343348 | 553206 <u>243037</u> | |
| RS 1.8 T (2WD) , 1.8 T (4WD) | (1U2) 5.01 - 5.06 | | | | | | | |
| | | 915415 | SM1708 | | 915400 | SM9703 ²⁾ SM9704 ³⁾ | | |
| | | 915415 | SM1708 | | 915400 ¹⁾ | SM9703 ²⁾ SM9704 ³⁾ | | |

1) Exc. 1.8 T **(4WD)** 2) SM9703 : OE p/n = 1J0513353D 3) SM9704 : OE p/n = 1J0513353B

Octavia I Combi (1U5)

| | | | | | | | | |
|--|-----------------------|--------|--------|--|--------|--|---------|--|
| (2WD) 1.4 16V, 1.6, 1.9 SDi Exc. Sport sus., , RS Exc. Self Leveling () | (1U5) 7.98 - 12.10 | 633713 | 333713 | | | 343298 | 553232▼ | |
| (2WD) 1.8 20V, 1.8 T, 1.9 TDi, 2.0 Exc. Sport sus., , RS Exc. Self Leveling () | (1U5) 7.98 - 12.10 | 634812 | 334812 | | | 343298 | 553232▼ | |
| ALL (4WD) Exc. Sport sus., Exc. Self Leveling () | (1U5) 5.98 - 7.00 | 634812 | 334812 | | | 344301 | | |
| ALL (4WD) Exc. Sport sus., Exc. Self Leveling () | (1U5) 8.00 - 6.04 | | 334670 | | | 344301 | | |
| (2WD) RS 1.8 T | (1U5) 8.02 - 1.06 | | | | | | | |
| | | 915415 | SM1708 | | 915400 | SM9703 ¹⁾ SM9704 ²⁾ | | |
| | | 915415 | SM1708 | | 915400 | SM9703 ¹⁾ SM9704 ²⁾ | | |

1) SM9703 : OE p/n = 1J0513353D 2) SM9704 : OE p/n = 1J0513353B

Octavia II (1Z3)

| | | | | | | | | |
|---|----------------------|----------------------|--|--|----------------------|-------------------------|--|--|
| (2WD) ALL Exc. Sport sus., , RS | (1Z3) 2.04 - 2.13 | | 334834 ¹⁾ 335808 ²⁾ <u>324703¹⁾</u> <u>325700²⁾</u> | | | 344459 <u>354006</u> | | |
| | | 910059 ³⁾ | SM1714 | | 910045 ⁶⁾ | SM9708 ⁶⁾ | | |
| | | 910057 ⁴⁾ | | | 910056 ⁷⁾ | SM9709 ⁷⁾ | | |
| | | 910177 ⁵⁾ | | | | | | |

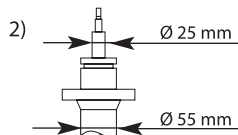
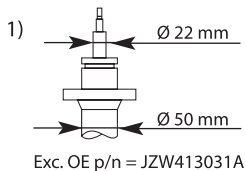

3) Normal sus.

4) Sport sus.

5)

6) OE = & → SM9708

7) OE = & → SM9709



| MODEL FAHRZEUG MODELE | YEAR JAHR ANNEE | FRONT/VORNE/AVANT | | | REAR/HINTEN/ARRIERE | |
|---|-----------------------|-----------------------------|---|--------------------------------|--|-----------------------------|
| | | PREMIUM Twin-tube Oil | EXCEL-G Twin-tube Gas | GAS-A-JUST Mono-tube Gas | | PREMIUM Twin-tube Oil |
| Skoda (CS) | | | | | | |
| Octavia II Combi (1Z5) | | | | | | |
| (2WD) (4WD) ALL Exc. Sport sus., RS | (1Z5) 2.04 - 2.13 | | 334834 ¹⁾ 335808 ²⁾ 324703 ¹⁾ 325700 ²⁾ 910059 ³⁾ SM1714 910057 ⁴⁾ 910177 ⁵⁾ | | 344459 354006 910045 ⁶⁾ SM9708 ⁶⁾ 910056 ⁷⁾ SM9709 ⁷⁾ | |
| 1) $\varnothing 22\text{ mm}$ 2) $\varnothing 25\text{ mm}$ $\varnothing 50\text{ mm}$ $\varnothing 55\text{ mm}$ Exc. OE p/n = JZW413031A | | | | | | |
| 3) Normal sus. 4) Sport sus. 5) 6) & → SM9708 7) & → SM9709 | | | | | | |
| Octavia III (5E3) | | | | | | |
| (2WD) 1.0 TSi, 1.2 TSi, 1.4 TSi, 1.4 TSi G-TEC 1.6, 1.8 TSi, 2.0 TSi RS (162 kW, 169 kW) 1.6 TDi (kW : 66, 77, 81), 2.0 TDi, 2.0 TDi RS Incl. Sport sus., Exc. | (5E3) 11.12 - | | 3348039 ¹⁾ 3358015 ²⁾ 910255 ⁵⁾ SM1051 | | 3448024 ³⁾ 3448025 ⁴⁾ 910332 ⁵⁾ SM9925 | |
| (2WD) 1.5 TSi, 1.6 TDi (85 kW) Exc. Sport sus., | (5E3) 2.17 - | | 3348039 ¹⁾ 3358015 ²⁾ 910255 ⁵⁾ SM1051 | | 3448024 ³⁾ 3448025 ⁴⁾ 910332 ⁵⁾ SM9925 | |
| (2WD) 2.0 TSi RS (180 kW) Exc. | (5E3) 2.17 - | | 3348039 ¹⁾ 3358015 ²⁾ 910255 ⁵⁾ SM1051 | | SM9925 | |
| (4WD) 1.8 TSi 1.6 TDi (77 kW, 81 kW), 2.0 TDi (110 kW) Incl. Sport sus., Exc. | (5E3) 9.14 - | | 3348039 ¹⁾ 3358015 ²⁾ 910255 ⁵⁾ SM1051 | | 910332 ⁵⁾ SM9925 | |
| (4WD) 2.0 TDi (135 kW) Incl. Sport sus. Exc. | (5E3) 9.14 - | | 3348039 ¹⁾ 3358015 ²⁾ 910255 ⁵⁾ SM1051 | | 3448024 ³⁾ SM9925 | |
| 1) 550 mm $\varnothing 50\text{ mm}$ 2) OE Lmax = 520 / 550 mm $\varnothing 55\text{ mm}$ 3) Lmax = 625 mm $\varnothing 13\text{ mm}$ 59 mm 4) Lmax = 640 / 650 mm $\varnothing 13\text{ mm}$ 45 mm 5) → 5.15 Bumper height : 80 mm 6) Multilink axle Incl. Exc. Sport sus., | | | | | | |



Skoda

| MODEL FAHRZEUG MODELE | YEAR JAHR ANNEE | FRONT/VORNE/AVANT | | | REAR/HINTEN/ARRIERE | | |
|-----------------------------|-----------------------|-----------------------------|-----------------------------|--------------------------------|-----------------------------|-----------------------------|--------------------------------|
| | | PREMIUM Twin-tube Oil | EXCEL-G Twin-tube Gas | GAS-A-JUST Mono-tube Gas | PREMIUM Twin-tube Oil | EXCEL-G Twin-tube Gas | GAS-A-JUST Mono-tube Gas |

Skoda (CS)

Octavia III Combi (5E5)

| | | | | | | |
|---|---------------|--|--|--|--|--|
| [2WD] 1.0 TSi, 1.2 TSi, 1.4 TSi, 1.6, 1.8 TSi 1.6 TDi (kW : 66, 77, 81), 2.0 TDi Incl. Sport sus., Exc. , RS | (5E5) 11.12 - | | 3348039 ¹⁾ 3358015 ²⁾ | | 3448024 ³⁾ 3448025 ⁴⁾ | |
| [2WD] 1.4 TSi G-TEC, 2.0 TSi RS (180 kW) Exc. | (5E5) 11.13 - | | 3348039 ¹⁾ 3358015 ²⁾ | | | |
| [2WD] 1.5 TSi, 2.0 TSi, 1.6 TDi (85 kW) Exc. Sport sus., , | (5E5) 2.17 - | | 3348039 ¹⁾ 3358015 ²⁾ | | 3448025 ⁴⁾ | |
| [2WD] 2.0 TSi RS (162 kW, 169 kW), 2.0 TDi RS Incl. Sport sus. Exc. H/D, | (5E5) 11.12 - | | 3348039 ¹⁾ 3358015 ²⁾ | | 3448024 ³⁾ | |
| [4WD] 1.8 TSi, 1.6 TDi (77 kW, 81 kW) 2.0 TDi, 2.0 TDi RS Incl. Sport sus., Exc. H/D, , Scout | (5E5) 11.12 - | | 3348039 ¹⁾ 3358015 ²⁾ | | 3448024 ³⁾ | |
| [4WD] 1.6 TDi (85 kW) Exc. | (5E5) 2.17 - | | 3348039 ¹⁾ 3358015 ²⁾ | | | |
| [4WD] 1.8 TSi, 2.0 TDi, 2.0 TDi RS H/D Exc. Sport sus., , , Scout | (5E5) 9.14 - | | 3348039 ¹⁾ 3358015 ²⁾ | | | |
| [4WD] Scout Exc. | (5E5) 11.12 - | | 3348039 ¹⁾ 3358015 ²⁾ | | | |

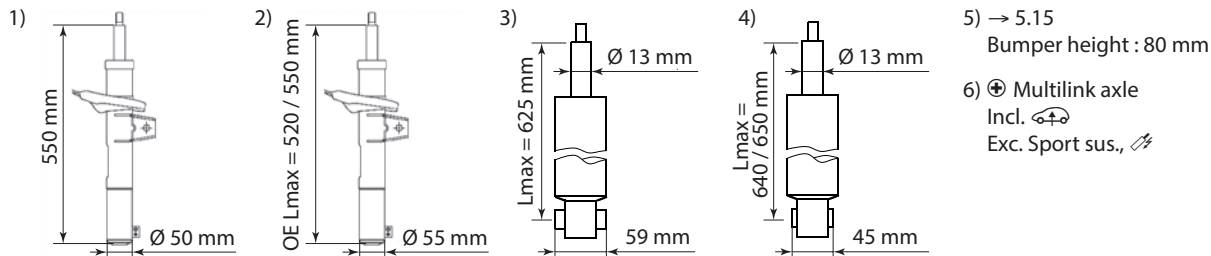

Octavia IV (NX3) , Octavia IV Combi (NX5)

| | | | | | | |
|--|--------------------|--|--|--|--|--|
| [2WD] [4WD] [ALL] Multilink axle Incl. Exc. Sport sus., | (NX3, NX5) 11.19 - | | | | | |
|--|--------------------|--|--|--|--|--|



| MODEL FAHRZEUG MODELE | YEAR JAHR ANNEE | FRONT/VORNE/AVANT | | | | REAR/HINTEN/ARRIERE | | | |
|--|-----------------------|--|--|--------------------------------|--|-----------------------------|-----------------------------|--------------------------------|--|
| | | PREMIUM Twin-tube Oil | EXCEL-G Twin-tube Gas | GAS-A-JUST Mono-tube Gas | | PREMIUM Twin-tube Oil | EXCEL-G Twin-tube Gas | GAS-A-JUST Mono-tube Gas | |
| Skoda (CS) | | | | | | | | | |
| Pick-Up, Felicia Pick-Up | | | | | | | | | |
| (787) | 93 - 95 | 633835 913268 | 333835 SM5505 | | | 441800 | | SM9700 | |
| 1.3, 1.6, 1.9 D (797) | 96 - | 633835 913268 | 333835 SM5505 | | | 443291 | 343285 | | |
| Rapid, Rapid Spaceback | | | | | | | | | |
| (NH_, NK_) | 7.12 - | | 339763 SM1708 | | | | 344357 SM9703 | | |
| Roomster , Praktik | | | | | | | | | |
| 1.2, 1.2 TDi, 1.2 TSi, 1.4, 1.4 TDi, 1.6, 1.6 TDi, 1.9 TDi (5J) | 3.06 - | | 334835 324702 910084 SM1708 ¹⁾ SM1713 ²⁾ | | | | 343298 910137 SM9703 | 553232 ▼ | |
| 1) 12.08 → 5J-9B601 132 → 5J-9B601 131 5J-95032 165 → | | 2) → 12.08 5J-9B601 131 5J-95032 164 | | | | | | | |
| Scala | | | | | | | | | |
| Exc. | (NW1) 2.19 - | | 3348074 | | | | 3430079 ³⁾ ◊ | | |
| Exc. | (NW1) 2.19 - | | 3348074 ¹⁾ 3348090 ²⁾ | | | | 3430074 | | |
| <div style="display: flex; justify-content: space-around;"> <div style="text-align: center;"> <p>1)</p> <p>180 mm</p> </div> <div style="text-align: center;"> <p>2)</p> <p>170 mm</p> </div> <div style="text-align: center;"> <p>3)</p> <p>Lmax = 685 mm</p> </div> </div> | | | | | | | | | |
| Superb I | | | | | | | | | |
| Exc. , Sport sus. | (3U4) 2.02 - 3.08 | | 341844 915708 SM5380 | | | | 343281 910003 SM5379 | 553207 | |
| Sport sus., Exc. | (3U4) 2.02 - 3.08 | | | | | | 343281 | | |
| Exc. Sport sus. | (3U4) 2.02 - 3.08 | | 341301 915708 | | | | 345027 | | |



Skoda

| MODEL FAHRZEUG MODELE | YEAR JAHR ANNEE | FRONT/VORNE/AVANT | | | | REAR/HINTEN/ARRIERE | | | |
|---|-----------------------|-----------------------------|-----------------------------|--------------------------------|--|-----------------------------|-----------------------------|--------------------------------|--|
| | | PREMIUM Twin-tube Oil | EXCEL-G Twin-tube Gas | GAS-A-JUST Mono-tube Gas | | PREMIUM Twin-tube Oil | EXCEL-G Twin-tube Gas | GAS-A-JUST Mono-tube Gas | |
| Skoda (CS) | | | | | | | | | |
| Superb II | | | | | | | | | |
| (2WD) Exc. Sport sus., | (3T4, 3T5) | 3.08 - | | 335808 ¹⁾ 325700 | | | 3440030 | | |
| | | | 910059 | SM1714 | | 910056 | SM9709 ³⁾ | | |
| (4WD) Exc. Sport sus., | (3T4, 3T5) | 3.08 - | | 335808 ¹⁾ 325700 | | | 344459 ²⁾ | | |
| | | | 910059 | SM1714 | | 910056 | SM9709 ³⁾ | | |
| (2WD) (4WD) Exc. Sport sus., | (3T4, 3T5) | 3.08 - | | 335808 ¹⁾ | | | | | |
| | | | | SM1714 | | 910056 | SM9709 ³⁾ | | |
| (4WD) Exc. Sport sus., | (3T4) | 3.08 - | | | | | 344459 | | |
| | | | 910059 | SM1714 | | 910056 | SM9709 ³⁾ | | |
| 1) Exc. Comfort Version 2) (4WD) Normal sus. : → 5.10 3) →5.10 | | | | | | | | | |
| Superb III | | | | | | | | | |
| (2WD) (4WD) Incl. Sport sus. Exc. | (3V3, 3V5) | 3.15 - | | 3358015 | | | 3448024 | | |
| | | | | SM1051 | | 910332 ¹⁾ | SM9925 | | |
| (2WD) (4WD) Exc. Sport sus., | (3V3, 3V5) | 3.15 - | | | | | 3448024 | | |
| | | | | SM1051 | | 910332 | SM9925 | | |
| 1) Exc. Sport sus. | | | | | | | | | |
| Yeti | | | | | | | | | |
| Exc. | (5L) | 5.09 - 12.17 | | 334834 324703 | | | 344459 354006 | | |
| | | | 910004 | SM1714 | | 910056 | SM9709 | | |
| Exc. | (5L) | 5.09 - 12.17 | | 334834 324703 | | | 349137 | | |
| | | | 910004 | SM1714 | | 910157 | SM9709 | | |



| MODEL FAHRZEUG MODELE | YEAR JAHR ANNEE | FRONT/VORNE/AVANT | | | | REAR/HINTEN/ARRIERE | | | |
|---|-----------------------|-----------------------------|-----------------------------|--------------------------------|--|-----------------------------|-----------------------------|--------------------------------|--|
| | | PREMIUM Twin-tube Oil | EXCEL-G Twin-tube Gas | GAS-A-JUST Mono-tube Gas | | PREMIUM Twin-tube Oil | EXCEL-G Twin-tube Gas | GAS-A-JUST Mono-tube Gas | |
| Smart (D) | | | | | | | | | |
| Cabrio | | | | | | | | | |
| ⊕ 0.6 Exc. Brabus | (450) | 3.00 - 12.00 | | 332900 | | | 343440 | | |
| | | | 910153 | SM5674 ²⁾ | | | | | |
| ⊕ 0.6, 0.7, 0.8 CDi Exc. Brabus | (450) | 3.00 - 1.04 | | 332901 ¹⁾ | | | 343440 | | |
| | | | 910153 | SM5674 ²⁾ | | | | | |
| City-Coupé | | | | | | | | | |
| ⊕ 0.6, 0.8 CDi Exc. Brabus | (450) | 7.98 - 12.00 | | 332900 | | | 343440 | | |
| | | | 910153 | SM5674 ²⁾ | | | | | |
| ⊕ 0.6, 0.7, 0.8 CDi Exc. Brabus | (450) | 7.98 - 1.04 | | 332901 ¹⁾ | | | 343440 | | |
| | | | 910153 | SM5674 ²⁾ | | | | | |
| Cross-blade | | | | | | | | | |
| ⊕ 0.6 Exc. Brabus | (450) | 6.02 - 12.03 | | 332901 ¹⁾ | | | 343440 | | |
| | | | | SM5674 ²⁾ | | | | | |
| 1) 2) Incl. Brabus | | | | | | | | | |
| Forfour | | | | | | | | | |
| Forfour I Exc. 1.5 Brabus, Sport sus., Brabus sus. | (454) | 1.04 - 6.06 | | 3338044 L 3338043 R | | | 343411 | | |
| | | | 912051 | SM1032 | | | 910167 | SM9923 | |
| Forfour I ⊕ Sport sus., Brabus sus. Exc. 1.5 Brabus | (454) | 1.04 - 6.06 | | 3338044 L 3338043 R | | | | | |
| | | | 912051 | SM1032 | | | 910167 | SM9923 | |
| Forfour I 1.5 Brabus | (454) | 5.05 - 6.06 | | 3338044 L 3338043 R | | | | | |
| | | | 912051 | SM1032 | | | 910167 | SM9923 | |
| Forfour II Exc. Brabus | (453) | 7.14 - | | 3338022 | | | 3438007 | | |
| Forfour II 0.9 Brabus | (453) | 7.16 - | | | | | 3438008◇ | | |



SsangYong

| MODEL FAHRZEUG MODELE | YEAR JAHR ANNEE | FRONT/VORNE/AVANT | | | | REAR/HINTEN/ARRIERE | | | |
|---|-----------------------|------------------------------------|-----------------------------|--------------------------------|--|-----------------------------|-----------------------------|--------------------------------|--|
| | | PREMIUM Twin-tube Oil | EXCEL-G Twin-tube Gas | GAS-A-JUST Mono-tube Gas | | PREMIUM Twin-tube Oil | EXCEL-G Twin-tube Gas | GAS-A-JUST Mono-tube Gas | |
| Smart (D) | | | | | | | | | |
| Fortwo Coupé , Fortwo Cabrio | | | | | | | | | |
| Fortwo I , 0.7, 0.8 CDi ⊕ Exc. Brabus | (450) | 1.04 - 1.07 | | 332901 ¹⁾ | | | 343440 | | |
| | | | 910152 | SM5674 | | | | | |
| Fortwo II , Incl. Sport sus., Brabus | (451) | 1.07 - | | | | | | 553393 | |
| | | | 910253 | SM5674 | | | | | |
| Fortwo III Exc. Brabus | (453) | 7.14 - | | 3338022 | | | 3438007 | | |
| Fortwo III 0.9 Brabus | (453) | 7.16 - | | | | | 3438008◇ | | |
| Roadster | | | | | | | | | |
| 0.7 ⊕ Exc. Brabus | (452) | 4.03 - 11.05 | | 332901 ¹⁾ | | | 343440 | | |
| | | | 910152 | SM5674 ²⁾ | | | | | |
| Roadster Coupé | | | | | | | | | |
| 0.7 ⊕ Exc. Brabus | (452) | 4.03 - 11.05 | | 332901 ¹⁾ | | | 343440 | | |
| | | | 910152 | SM5674 ²⁾ | | | | | |
| 1) 2) Incl. Brabus | | | | | | | | | |
| SsangYong (KO) | | | | | | | | | |
| Actyon I | | | | | | | | | |
| 2.3 2.0 Xdi (100 kW) 2.0 Xdi (104 kW) | | 11.06 - 7.07 - 12.12 11.05 - | | 341612 | | | | | |
| Actyon Sport I | | | | | | | | | |
| 2.0 Xdi (104 kW) (QJ) | | 4.07 - | | 341612 | | | | | |
| Kyron | | | | | | | | | |
| 2.3 2.0 Xdi (100 kW, 104 kW) 2.0 Xdi | | 11.06 - 5.05 - 8.07 5.05 - | | 341612 | | | | | |
| 2.7 Xdi ⊕ | | 5.05 - | | 341612 | | | | | |
| Musso / Korando | | | | | | | | | |
| Incl. | | 10.93 - | | 344309 | | | 344310 | 554147▼ | |



| MODEL FAHRZEUG MODELE | YEAR JAHR ANNEE | FRONT/VORNE/AVANT | | | | REAR/HINTEN/ARRIERE | | | | | | | | | | | | |
|---|--|-----------------------------|--|--------------------------------|--|-----------------------------|--|--------------------------------|--|--|-----|-----|---------------|-------|---------|--------------------|-------|---------|
| | | PREMIUM Twin-tube Oil | EXCEL-G Twin-tube Gas | GAS-A-JUST Mono-tube Gas | | PREMIUM Twin-tube Oil | EXCEL-G Twin-tube Gas | GAS-A-JUST Mono-tube Gas | | | | | | | | | | |
| SsangYong (KO) | | | | | | | | | | | | | | | | | | |
| Rexton / Rexton II (02-) | | | | | | | | | | | | | | | | | | |
| Rexton 2.7 Xdi (121 kW) (2WD) (4WD) | (GAB_) 5.04 - 4.06 | | 341612 | | | | | | | | | | | | | | | |
| Rexton 2.3 RX230, 3.2 RX320 (4WD) 2.9 TD (2WD) Exc. | (GAB_) 4.02 - | | | | | | 345600 | | | | | | | | | | | |
| Rexton II 3.2 RX320 (4WD) 2.7 D (4WD) 2.7 Xdi (120 kW) (2WD) 2.7 Xdi (118 kW, 121 kW) (4WD) 2.7 Xdi Turbo (4WD) Exc. | (GAB_) 4.02 - 6.06 - 8.04 - 5.04 - 5.12 3.08 - | | 341612 | | | | | | | | | | | | | | | |
| Rexton (12-) (Off Road) | | | | | | | | | | | | | | | | | | |
| 2.0 Xdi (114 kW) (2WD) Exc. Rexton W | 7.12 - 3.14 | | 341612 | | | | | | | | | | | | | | | |
| Subaru (J) | | | | | | | | | | | | | | | | | | |
| E Series, Libero | | | | | | | | | | | | | | | | | | |
| E12 1.2 (2WD) E12 1.2 (4WD) | (FA7) (FA8) 5.93 - | | | | | 442037 | | | | | | | | | | | | |
| Forester | | | | | | | | | | | | | | | | | | |
| 2.0 (4WD) 2.0 S Turbo (4WD) Exc. | (SF5) 97 - 5.02 | | 334190 L 334189 R 324053 L 324052 R | | | | 334192 L ¹⁾ 334191 R ¹⁾ 324055 L 324054 R | | | | | | | | | | | |
| | | | 910105 SM5361 | | | | 910072 SM8101 L SM8102 R | | | | | | | | | | | |
| <p>1)</p> <table border="1"> <thead> <tr> <th></th> <th>(A)</th> <th>(B)</th> </tr> </thead> <tbody> <tr> <td>334191/334192</td> <td>402mm</td> <td>Shape N</td> </tr> <tr> <td>OE = Self Leveling</td> <td>408mm</td> <td>Shape F</td> </tr> </tbody> </table> | | | | | | | | | | | (A) | (B) | 334191/334192 | 402mm | Shape N | OE = Self Leveling | 408mm | Shape F |
| | (A) | (B) | | | | | | | | | | | | | | | | |
| 334191/334192 | 402mm | Shape N | | | | | | | | | | | | | | | | |
| OE = Self Leveling | 408mm | Shape F | | | | | | | | | | | | | | | | |



Subaru

| MODEL FAHRZEUG MODELE | YEAR JAHR ANNEE | FRONT/VORNE/AVANT | | | | REAR/HINTEN/ARRIERE | | | |
|---|--|---|--|--------------------------------|--------|-----------------------------|--|--------------------------------|--|
| | | PREMIUM Twin-tube Oil | EXCEL-G Twin-tube Gas | GAS-A-JUST Mono-tube Gas | | PREMIUM Twin-tube Oil | EXCEL-G Twin-tube Gas | GAS-A-JUST Mono-tube Gas | |
| Subaru (J) | | | | | | | | | |
| Forester | | | | | | | | | |
| 2.0 2.0 S Turbo 2.5 RX Nato Exc. | (SG) 7.02 - 12.02 | | 334343 L 334342 R | | | | 334345 L 334344 R | | |
| | | 910105 | SM5361 | | | 910046 | SM5422 | | |
| 2.0 2.0 S Turbo 2.5 RX Nato Exc. | (SG) 1.03 - 1.03 - 1.03 - | | 334371 L 334370 R | | | | 334345 L 334344 R | | |
| | | 910105 | SM5361 | | | 910046 | SM5422 | | |
| 2.0 X 2.5 XT 2.5 | (SG) 9.05 - 5.06 9.05 - 5.06 12.03 - 5.06 | | 334469 L 334468 R | | | | 339150 L ³⁾ 339149 R ³⁾ | | |
| | | 910105 | SM5361 | | | 910046 | SM5422 | | |
| 2.0, 2.0 D, 2.0 Bifuel 2.5, 2.5 Turbo Exc. | (SH) 1.08 - | | 339170 L ¹⁾ 339169 R ²⁾ | | | | | | |
| | | | SM5664 | | | 910286 | SM5786 | | |
| 2.0, 2.0 D, 2.5 Exc. | (SJ) 3.13 - | | | | | | | | |
| | | | | | | 910286 | | | |
| 2) Exc. OE = 20310SC110 20310SC111 20310SC130 20310SC131 20310SC090 | | 3) Exc. OE = 20310SC100 20310SC101 20310SC120 20310SC121 20310SC080 | | 4) 2.5 | | | | | |
| Impreza (GC), (GF) | | | | | | | | | |
| 1.6, 1.8, 2.0 | (GC/GF 3/5/7) | 92 - 12.00 | | 334254 L 334253 R | | | 334147 L 334146 R | | |
| | | | | SM5361 | | | | | |
| 1.6, 1.8, 2.0 Exc. GT (2.0 Turbo) | (GC/GF 4/6/8) | 92 - 12.00 | | 334254 L 334253 R | | | 334110 L 334109 R | | |
| | | | | SM5361 | | | SM5243 | | |
| 2.0 Turbo Exc. STi ver. | (GC/GF8*L8) | 92 - 12.00 | | 334256 L 334255 R | | | 334110 L 334109 R | | |
| | | | | SM5361 | | | SM5243 | | |
| Impreza (GD), (GG) | | | | | | | | | |
| 1.6, 2.0, 2.0 Turbo WRX, 2.5 Exc. WRX-STi | (GD) | 10.00 - 10.02 | | 334305 L 334304 R | | | 334307 L 334306 R | | |
| | | | | 910142 | SM5361 | | 910046 | SM8101 L SM8102 R | |
| 2.0 Turbo WRX-STi | (GDB) | 10.00 - 10.02 | | 321007 L 321006 R | | | 321009 L 321008 R | | |
| | | | | | | | SM8101 L SM8102 R | | |



| MODEL FAHRZEUG MODELE | YEAR JAHR ANNEE | FRONT/VORNE/AVANT | | | | REAR/HINTEN/ARRIERE | | | |
|--|-----------------------|-----------------------------|------------------------------|--|--|-----------------------------|--|--------------------------------|--|
| | | PREMIUM Twin-tube Oil | EXCEL-G Twin-tube Gas | GAS-A-JUST Mono-tube Gas | | PREMIUM Twin-tube Oil | EXCEL-G Twin-tube Gas | GAS-A-JUST Mono-tube Gas | |
| Subaru (J) | | | | | | | | | |
| Impreza (GD), (GG) | | | | | | | | | |
| 1.6, 2.0, 2.0 Turbo WRX, 2.5 Exc. WRX-STi | (GD) | 11.02 - 12.02 | | 334305 L 334304 R | | | 334359 L 334358 R 324031 L 324030 R | | |
| | | | 910142 SM5361 | | | | 910046 SM8101 L SM8102 R | | |
| 2.0 Turbo WRX-STi | (GDB) | 11.02 - 12.02 | | 321007 L 321006 R | | | 321005 L 321004 R | | |
| | | | | | | | | | |
| 1.5, 1.6, 2.0, 2.0 Turbo WRX 2.5, 2.5 WRX Exc. WRX-STi | (GD) | 1.03 - 12.07 | | 334461 L 334460 R 324033 L 324032 R | | | 334359 L 334358 R 324031 L 324030 R | | |
| | | | 910142 SM5361 | | | | 910046 SM8101 L SM8102 R | | |
| 2.0 Turbo WRX-STi | (GDB) | 1.03 - 6.04 | | 321003 L 321002 R | | | 321005 L 321004 R | | |
| | | | | | | | | | |
| 1.6, 2.0, 2.0 Turbo WRX Exc. WRX-STi | (GG) | 10.00 - 10.02 | | 334301 L 334300 R | | | 334303 L 334302 R | | |
| | | | 910142 SM5361 | | | | 910046 SM8101 L SM8102 R | | |
| 1.6, 2.0, 2.0 Turbo WRX Exc. WRX-STi | (GG) | 11.02 - 12.02 | | 334301 L 334300 R | | | 334357 L 334356 R | | |
| | | | 910142 SM5361 | | | | 910046 SM8101 L SM8102 R | | |
| 1.5, 1.6, 2.0, 2.0 i R, 2.0 Turbo WRX Exc. WRX-STi | (GG) | 1.03 - 12.07 | | 334463 L 334462 R 324035 L 324034 R | | | 334357 L 334356 R 324037 L 324036 R | | |
| | | | 910142 SM5361 ¹⁾ | | | | 910046 SM8101 L SM8102 R | | |
| 1) Incl. 2.5 , 2.5 WRX | | | | | | | | | |
| Impreza | | | | | | | | | |
| 2.0 i | | 12.02 - 12.07 | | | | | | | |
| | | | 910142 SM5361 | | | | | | |
| Impreza (GR) | | | | | | | | | |
| 1.5 1.5 F | (GR) | 1.08 - 2.08 - 7.09 | | 339227 L 339226 R | | | 341487 | | |
| | | | | SM5664 | | | 910286 SM5786 | | |
| 2.0 (110 kW, 118 kW) 2.5 (169 kW) 2.0 (110 kW) | (GR) | 1.08 - | | 339172 L 339171 R | | | 341487 | | |
| | | | | | | | 910286 SM5786 | | |



Subaru

| MODEL FAHRZEUG MODELE | YEAR JAHR ANNEE | FRONT/VORNE/AVANT | | | | REAR/HINTEN/ARRIERE | | | |
|--|-----------------------|-----------------------------|-----------------------------|--------------------------------|--|-----------------------------|-------------------------------|--------------------------------|--------|
| | | PREMIUM Twin-tube Oil | EXCEL-G Twin-tube Gas | GAS-A-JUST Mono-tube Gas | | PREMIUM Twin-tube Oil | EXCEL-G Twin-tube Gas | GAS-A-JUST Mono-tube Gas | |
| Subaru (J) | | | | | | | | | |
| Impreza (GP_), (GJ_) | | | | | | | | | |
| (GP_, GJ_) 6.12 - 1.6 i (84 kW) | | | 339388 L 339387 R | | | | 340096 | | |
| | | | | | | | SM5786 | | |
| (GP_) 1.12 - 2.0 (110 kW) Exc. Hybrid | | | 339413 L 339412 R | | | | 340116 | | |
| | | | | | | | SM5786 | | |
| (GJ_) 7.11 - 11.16 2.0 (110 kW) | | | 339388 L 339387 R | | | | 340096 | | |
| | | | | | | | SM5786 | | |
| Justy, J Series | | | | | | | | | |
| (KA, KD) JF1K**K JF1K**S | 7.88 - 95 | 633207 L 633206 R | | | | 632131 | | | |
| (HSJ56, HSN56) =TSMM** Exc. ABS | 96 - 8.03 | 633134 L 633133 R | 333195 L 333194 R | | | 633174▼ | 333196 | | |
| | | | | 910083 | | | | | |
| (GX3) | 9.03 - 12.06 | | 332804 L 332803 R | | | | 343331 | | |
| | | | | 910108 | | | | | |
| Justy | | | | | | | | | |
| 1.0 | 1.07 - | | 332120 | | | | 343406 | | |
| Legacy Exc. | | | | | | | | | |
| (BC/BF/BJ) 89 - 6.91 1.6, 1.8, 2.0, 2.2 | | | 334106 L 334105 R | | | | 334145 L 334144 R | | |
| | | | | | | | SM5361 | | |
| | | | | | | | O.E. =20361AA*** | | |
| (BC/BF/BJ) 7.91 - 12.93 1.6, 1.8, 2.0, 2.2 | | | 334106 L 334105 R | | | | 334147 L 334146 R | | |
| | | | | | | | SM5361 | | |
| | | | | | | | O.E. =20361AA*** | | |
| (BD/BG) 1.94 - 99 2.0, 2.2 | | | 334254 L 334253 R | | | | 334165 L 334164 R | | |
| | | | | | | | SM5361 | | |
| | | | | | | | SM5247 L▼ SM5246 R▼ | | |
| (BC/BF/BJ) 89 - 6.91 1.8, 2.2 Exc. | | | 334106 L 334105 R | | | | 334108 L 334107 R | | |
| | | | | | | | SM5361 | | |
| | | | | | | | O.E. =20361AA*** | | |
| (BC/BF/BJ) 1.90 - 6.91 1.8, 2.2 | | | 334106 L 334105 R | | | | | | |
| | | | | | | | SM5361 | | |
| | | | | | | | O.E. =20361AA28*/29*, 48*/49* | | |
| (BC/BF/BJ) 7.91 - 12.93 1.8, 2.0, 2.2 Exc. 2.0 Turbo (BC/BF5*L8) | | | 334106 L 334105 R | | | | 334110 L 334109 R | | |
| | | | | | | | SM5361 | | |
| | | | | | | | O.E. =20361AA*** | | SM5243 |



| MODEL FAHRZEUG MODELE | YEAR JAHR ANNEE | FRONT/VORNE/AVANT | | | | REAR/HINTEN/ARRIERE | | | |
|--|-----------------------|-----------------------------|--|--------------------------------|--|--|-----------------------------|--------------------------------|--|
| | | PREMIUM Twin-tube Oil | EXCEL-G Twin-tube Gas | GAS-A-JUST Mono-tube Gas | | PREMIUM Twin-tube Oil | EXCEL-G Twin-tube Gas | GAS-A-JUST Mono-tube Gas | |
| Subaru (J) | | | | | | | | | |
| Legacy Exc. | | | | | | | | | |
| (4WD) 2.0 Turbo (BC/BF5*L8) | 7.91 - 12.93 | | 334112 L 334111 R SM5361 | | | 334110 L 334109 R SM5243 | | | |
| (4WD) 2.0, 2.2 (BD/BG 5,7) | 1.94 - 5.96 | | 334254 L 334253 R SM5361 | | | 334116 L 334115 R O.E. =20362AC*** SM8101 L SM8102 R | | | |
| (4WD) 2.0, 2.2 (BD/BG 5,7) | 6.96 - 99 | | 334254 L 334253 R SM5361 | | | 334116 L 334115 R O.E. =20363 AC*** 335019 L 335018 R O.E. =20364 AC*** SM8101 L SM8102 R | | | |
| (4WD) 2.5 Exc. Outback (BD/BG9*L9) (BG9*LB) | 6.96 - 99 | | 334112 L 334111 R SM5361 | | | 335019 L 335018 R SM8101 L SM8102 R | | | |
| (4WD) 2.5 Outback (BG9*LB) | 6.96 - 99 | | 334167 L 334166 R SM5361 | | | 335021 L 335020 R SM8101 L SM8102 R | | | |
| (4WD) 2.0, 2.5 Exc. , Outback (BE/BH) | 12.98 - 9.03 | | 334274 L 334273 R SM5361 | | | 341275 SM5214 | | | |
| (4WD) 2.5 Outback, 3.0 Outback Exc. (BE/BH) | 12.98 - 9.03 | | 334276 L 334275 R SM5361 | | | 341276 SM5214 | | | |
| (4WD) 2.0 i, 2.0 D, 2.5 i, 3.0 R, 2.0 R Exc. 3.0 R Spec B, Outback (BL) | 9.03 - | | 334373 L 334372 R 910093 SM5797 | | | 341353 940002 SM5214 | | | |
| (4WD) Outback 2.0 i, 2.0 D, 2.5 i, 2.5 Bifuel, 3.0 R (BP) | 9.03 - | | 334375 L 334374 R 910093 SM5797 | | | 341354 940002 SM5214 | | | |
| 2.0 i, 2.0 D, 2.5 i (BM, BR) | 9.09 - | | 339239 L 339238 R 910093 SM5664 | | | 340043 910286 SM5786 | | | |
| 2.5 GT (BM, BR) | 7.10 - | | 339239 L 339238 R 910093 SM5664 | | | 340042 910286 SM5786 | | | |



Subaru

| MODEL FAHRZEUG MODELE | YEAR JAHR ANNEE | FRONT/VORNE/AVANT | | | | REAR/HINTEN/ARRIERE | | | |
|---|-------------------------------------|-----------------------------|-----------------------------|--------------------------------|--|-----------------------------|-----------------------------|--------------------------------|--|
| | | PREMIUM Twin-tube Oil | EXCEL-G Twin-tube Gas | GAS-A-JUST Mono-tube Gas | | PREMIUM Twin-tube Oil | EXCEL-G Twin-tube Gas | GAS-A-JUST Mono-tube Gas | |
| Subaru (J) | | | | | | | | | |
| L Series | | | | | | | | | |
| | (AU2) | 5.79 - 84 | | | | | 343284 | | |
| | | | OE= 721032 240/241 | | | | | | |
| | (AU2) | 84 - | | | | | 343284 | | |
| | | | OE= 721032 081 | | | | | | |
| | (AU5) | 5.79 - | | | | | 343284 | | |
| L Series, Leone Exc. | | | | | | | | | |
| 1300 DL | (AN1) | 8.84 - 91 | | | | | 341214▼ | | |
| 1600 DL, 1800 DL, GL | (AN2, AN4) | 8.84 - 93 | | | | | 341214▼ | | |
| 1600 DL | (AN3) | 8.84 - 7.85 | | | | | | | |
| | | | SM5364▼ | | | | SM5362▼ | | |
| 1800 DL, GL | (AN5, AK5) | 8.84 - 7.85 | | | | | | | |
| | | | SM5364▼ | | | | SM5362▼ | | |
| 1600 DL, 1800 DL, GL | (AN3, AN5, AK5) | 8.85 - 7.86 | | | | | | | |
| | | | SM5364▼ | | | | SM5362▼ | | |
| 1600 DL, 1800 DL, GL | (AN3, AN5, AK5) | 8.86 - 93 | | | | | 341216▼ | | |
| | | | SM5364▼ | | | | SM5362▼ | | |
| L Series, Leone (AG), (AC), XT (AX) (8.84-93) Exc. | | | | | | | | | |
| 1300, 1600, 1800 DL, GL, GT | (AG1, AG2, AG4) | 8.85 - 90 | | | | | | | |
| 1300, 1600, 1800 DL, GL, GT | (AC1, AC2, AC4) | 8.84 - 93 | | | | | 341214▼ | | |
| 1300, 1600, 1800 DL, GL, GT | (AC1, AC2, AC4) | 8.84 - 93 | | | | | 341214▼ | | |
| XT 1800 Turbo | (AX4) | 8.84 - 91 | | | | | 341214▼ | | |
| | | | SM5364▼ | | | | SM5362▼ | | |
| 1800 GL 4WD Turbo Exc. RX | (AG5* L3) (AG5* L9) (AG5* L8) | 8.85 - 7.86 | | | | | | | |
| | | | SM5364▼ | | | | SM5362▼ | | |
| 1800 GL 4WD Turbo Exc. RX | (AG5* L3) (AG5* L9) (AG5* L8) | 8.86 - 90 | | | | | 341216▼ | | |
| | | | SM5364▼ | | | | SM5362▼ | | |
| 1800 DL, GL | (AC5* L2/L3) | 8.84 - 89 | | | | | | | |
| | | | SM5364▼ | | | | SM5362▼ | | |



| MODEL FAHRZEUG MODELE | YEAR JAHR ANNEE | FRONT/VORNE/AVANT | | | | REAR/HINTEN/ARRIERE | | | |
|---|---------------------------------------|-----------------------------|-----------------------------|--------------------------------|--|-----------------------------|-----------------------------|--------------------------------|--|
| | | PREMIUM Twin-tube Oil | EXCEL-G Twin-tube Gas | GAS-A-JUST Mono-tube Gas | | PREMIUM Twin-tube Oil | EXCEL-G Twin-tube Gas | GAS-A-JUST Mono-tube Gas | |
| Subaru (J) | | | | | | | | | |
| L Series, Leone (AG), (AC), XT (AX) (8.84-93) Exc. | | | | | | | | | |
| RX 1800 Turbo (AC/AG5* L8) Exc. 4WD Turbo (AG7, AC7) | 8.84 - 7.86 | | | | | | | | |
| | | | | | | | | | |
| | | | | | | | | | |
| | | | | | | | | | |
| | | | | | | | | | |
| | | | | | | | | | |
| | | | | | | | | | |
| | | | | | | | | | |
| Outback Exc. | | | | | | | | | |
| 2.0 D, 2.5 i, 3.6 R (BM, BR) | 9.09 - | | | | | | | | |
| | | | | | | | | | |
| | | | | | | | | | |
| | | | | | | | | | |
| | | | | | | | | | |
| | | | | | | | | | |
| | | | | | | | | | |
| Rex 600 | | | | | | | | | |
| (KF1) | 81 - | | | | | | | | |
| | | | | | | | | | |
| | | | | | | | | | |
| | | | | | | | | | |
| | | | | | | | | | |
| Trezza | | | | | | | | | |
| | 3.11 - | | | | | | | | |
| | | | | | | | | | |
| | | | | | | | | | |
| | | | | | | | | | |
| | | | | | | | | | |
| | | | | | | | | | |
| Tribeca | | | | | | | | | |
| 3.0 (184 kW) (B9) 3.0 (180 kW) 3.6 | 3.05 - 9.06 10.06 - 9.07 8.07 - | | | | | | | | |
| | | | | | | | | | |
| | | | | | | | | | |
| | | | | | | | | | |
| | | | | | | | | | |
| | | | | | | | | | |
| Vivio | | | | | | | | | |
| (KK/KW) | 8.93 - 7.94 | | | | | | | | |
| (KK/KW) | 8.94 - 10.95 | | | | | | | | |
| | | | | | | | | | |
| | | | | | | | | | |
| | | | | | | | | | |
| | | | | | | | | | |
| XV | | | | | | | | | |
| 1.6 i, 2.0 i, 2.0 D (108 kW) (_GP_) 1.6 BiFuel, 2.0 BiFuel | 3.12 - 3.12 - 11.12 | | | | | | | | |
| 1.6 BiFuel, 2.0 BiFuel (_GP_) 2.0 D (80 kW) | 12.12 - 3.12 - | | | | | | | | |
| | | | | | | | | | |
| | | | | | | | | | |
| | | | | | | | | | |
| | | | | | | | | | |
| Suzuki (J) | | | | | | | | | |
| Alto | | | | | | | | | |
| Alto (SS 30 V, SS 40 V) | 10.81 - | | | | | | | | |
| Alto 600 (SS 40 F) | 81 - | | | | | | | | |
| Alto 800 (SS 80 F, SS80 G) | 81 - 1.86 | 632006 | | | | | | | |



Suzuki

| MODEL FAHRZEUG MODELE | YEAR JAHR ANNEE | FRONT/VORNE/AVANT | | | | REAR/HINTEN/ARRIERE | | | |
|---|---|-----------------------------|-----------------------------|--|--|-----------------------------|-----------------------------|--------------------------------|--|
| | | PREMIUM Twin-tube Oil | EXCEL-G Twin-tube Gas | GAS-A-JUST Mono-tube Gas | | PREMIUM Twin-tube Oil | EXCEL-G Twin-tube Gas | GAS-A-JUST Mono-tube Gas | |
| Suzuki (J) | | | | | | | | | |
| Alto | | | | | | | | | |
| Alto II SB 308 (CA 91, CB 91) 00100001 → 00200000 | 7.86 - 12.87 | 632051 L 632050 R | | | | 442030 | | | |
| SM5108 | | | | | | | | | |
| Alto II SB 308 (CA 91, CB 91) 00200001 → | 88 - 92 | 632051 L 632050 R | | | | | 342020 | | |
| SM5108 | | | | | | | | | |
| Alto III SH 410 (FA 11, FB 11, EF_) | 94 - 5.02 | 632094 L 632093 R | | | | | 342018 | | |
| Alto IV 1.1 (FF/RF410) Exc. | 6.02 - 12.08 | 632141 L 632140 R | | | | | 342031 | | |
| SM1037 | | | | | | | | | |
| Alto V / Celerio 1.0, 1.0 LPG (GF/AMF310) | 1.09 - | | 332155 L 332154 R | | | | 348028 | | |
| Baleno Exc. | | | | | | | | | |
| (EG) 1.3 1.6 Incl. ABS | 95 - | 633222 L▼ 633221 R▼ | 333313 L 333312 R | | | 633186 L▼ 633185 R▼ | 333216 L 333215 R | | |
| (EG) 1.3 1.5 1.6 Incl. ABS | 95 - | 633222 L▼ 633221 R▼ | 333313 L 333312 R | | | | 333216 L 333215 R | | |
| (EG) 1.8 1.9 TD Incl. ABS | 95 - | | 333313 L 333312 R | | | | 333216 L 333215 R | | |
| (EG) 1.6 1.8 1.3 16V, 1.9 TD Incl. ABS | 95 - | | 333313 L 333312 R | | | | 333216 L 333215 R | | |
| Celerio | | | | | | | | | |
| (LF) | 3.14 - | | 3320023 L◇ 3320022 R◇ | | | | 3430032◇ | | |
| Grand Vitara I (JSAF TA/TD/TL ..., 2S2GTA ...) | | | | | | | | | |
| 1.6 2.0 2.0 TD 2.0 HDI 2.5 2.7 V6 Incl. ABS | (TA0 : SQ416) (TA5, TL5 : SQ420) (TD3 : SQ420) (TD6 : SQ425) | 3.98 - | 634090 L▼ 634089 R▼ | 334196 L 334195 R 324051 L 324050 R | | | 343247 | 553158 243040 | |
| SM5366 | | | | | | | | | |



| MODEL FAHRZEUG MODELE | YEAR JAHR ANNEE | FRONT/VORNE/AVANT | | | | REAR/HINTEN/ARRIERE | | | | | | | | | | | | | | | | | | | | | | | | | | | | | | | | | |
|---|------------------------------|-----------------------------|-----------------------------|--------------------------------|---------|-----------------------------|-----------------------------|--------------------------------|---------|------------|--------|-------------|----|-------|-------|----------|-------|----|-----|-------|----------|------|----|-----|-------|----------|------|----|-----|-------|----------|------|----|-----|-------|----------|------|----|-----|
| | | PREMIUM Twin-tube Oil | EXCEL-G Twin-tube Gas | GAS-A-JUST Mono-tube Gas | | PREMIUM Twin-tube Oil | EXCEL-G Twin-tube Gas | GAS-A-JUST Mono-tube Gas | | | | | | | | | | | | | | | | | | | | | | | | | | | | | | | |
| Suzuki (J) | | | | | | | | | | | | | | | | | | | | | | | | | | | | | | | | | | | | | | | |
| Grand Vitara II | | | | | | | | | | | | | | | | | | | | | | | | | | | | | | | | | | | | | | | |
| 1.6, 1.9 DDiS, 2.0 2.4 VVTi, 2.7 VVTi | (JT) | 4.05 - | | 334465 L 334464 R | | | 343435 | | | | | | | | | | | | | | | | | | | | | | | | | | | | | | | | |
| | | | 910066 | SM5720 | | | | | | | | | | | | | | | | | | | | | | | | | | | | | | | | | | | |
| Ignis | | | | | | | | | | | | | | | | | | | | | | | | | | | | | | | | | | | | | | | |
| (2WD) 1.3 Incl. ABS | (FH) | 10.00 - 9.03 | | 333347 L 333346 R | | | 342026 | | | | | | | | | | | | | | | | | | | | | | | | | | | | | | | | |
| (4WD) 1.3 Incl. ABS | (FH) | 10.00 - 9.03 | | 333347 L 333346 R | | | 342027 | | | | | | | | | | | | | | | | | | | | | | | | | | | | | | | | |
| 1.3 (2WD) (4WD) 1.5 (2WD) (4WD) Exc. 1.3 DDiS | (MH) | 9.03 - | | 332804 L 332803 R | | | 343331 | | | | | | | | | | | | | | | | | | | | | | | | | | | | | | | | |
| | | | 910108 | SM1035 ¹⁾ | | | | | | | | | | | | | | | | | | | | | | | | | | | | | | | | | | | |
| 1.3 DDiS | (MH) | 9.03 - | | 332806 L 332805 R | | | 343331 | | | | | | | | | | | | | | | | | | | | | | | | | | | | | | | | |
| | | | 910108 | SM1035 ¹⁾ | | | | | | | | | | | | | | | | | | | | | | | | | | | | | | | | | | | |
| 1) <table border="1"> <thead> <tr> <th>Model code</th> <th>Stroke</th> <th>Engine code</th> <th>kW</th> <th>Drive</th> </tr> </thead> <tbody> <tr> <td>RM413</td> <td>1.3 DDiS</td> <td>Z13DT</td> <td>51</td> <td>2WD</td> </tr> <tr> <td>RM413</td> <td>1.3 VVTi</td> <td>M13A</td> <td>69</td> <td>4WD</td> </tr> <tr> <td>RM413</td> <td>1.3 VVTi</td> <td>M13A</td> <td>69</td> <td>2WD</td> </tr> <tr> <td>RM415</td> <td>1.5 VVTi</td> <td>M15A</td> <td>73</td> <td>2WD</td> </tr> <tr> <td>RM415</td> <td>1.5 VVTi</td> <td>M15A</td> <td>73</td> <td>4WD</td> </tr> </tbody> </table> | | | | | | | | | | Model code | Stroke | Engine code | kW | Drive | RM413 | 1.3 DDiS | Z13DT | 51 | 2WD | RM413 | 1.3 VVTi | M13A | 69 | 4WD | RM413 | 1.3 VVTi | M13A | 69 | 2WD | RM415 | 1.5 VVTi | M15A | 73 | 2WD | RM415 | 1.5 VVTi | M15A | 73 | 4WD |
| Model code | Stroke | Engine code | kW | Drive | | | | | | | | | | | | | | | | | | | | | | | | | | | | | | | | | | | |
| RM413 | 1.3 DDiS | Z13DT | 51 | 2WD | | | | | | | | | | | | | | | | | | | | | | | | | | | | | | | | | | | |
| RM413 | 1.3 VVTi | M13A | 69 | 4WD | | | | | | | | | | | | | | | | | | | | | | | | | | | | | | | | | | | |
| RM413 | 1.3 VVTi | M13A | 69 | 2WD | | | | | | | | | | | | | | | | | | | | | | | | | | | | | | | | | | | |
| RM415 | 1.5 VVTi | M15A | 73 | 2WD | | | | | | | | | | | | | | | | | | | | | | | | | | | | | | | | | | | |
| RM415 | 1.5 VVTi | M15A | 73 | 4WD | | | | | | | | | | | | | | | | | | | | | | | | | | | | | | | | | | | |
| Jimny / Samurai / Santana | | | | | | | | | | | | | | | | | | | | | | | | | | | | | | | | | | | | | | | |
| Jimny | (LJ 10, 20, LJ 81) | 70 - 77 | 443156 | 343185 | 553107▼ | | 443194 | 343153 | 553106▼ | | | | | | | | | | | | | | | | | | | | | | | | | | | | | | |
| Jimny | (SJ 10, SJ 20, LJ 80 series) | 77 - | 443156 | 343185 | 553107▼ | | 443067 | | | | | | | | | | | | | | | | | | | | | | | | | | | | | | | | |
| Jimny, Samurai | (SJ 30, SJ 410, SJ 413) | 5.81 - 88 | 443156 | 343185 | 553107▼ | | 443194 | 343153 | 553106▼ | | | | | | | | | | | | | | | | | | | | | | | | | | | | | | |
| Samurai, Santana 1.3 | (SJ413) | 88 - | 443156 | 343185 | 553107▼ | | 443194 | 343153 | 553106▼ | | | | | | | | | | | | | | | | | | | | | | | | | | | | | | |
| Samurai, Santana 1.9 TD | (SJ419) | 98 - | | | 553220 | | | | 553221 | | | | | | | | | | | | | | | | | | | | | | | | | | | | | | |
| Jimny 1.3 (2WD) (4WD) JSAFJA33***, JSAFJB33*** Exc. 1.5 DDiS | (SN413: JA33, JB33) | 98 - | | 343287 | | | | 343288 | | | | | | | | | | | | | | | | | | | | | | | | | | | | | | | |
| 1.5 D, 1.5 DDiS | | 2.04 - | | 343287 | | | | 343288 | | | | | | | | | | | | | | | | | | | | | | | | | | | | | | | |
| Kizashi | | | | | | | | | | | | | | | | | | | | | | | | | | | | | | | | | | | | | | | |
| (2WD) (4WD) 2.4 | (FR) | 10.10 - | | 339266 L 339265 R | | | | 349141 | | | | | | | | | | | | | | | | | | | | | | | | | | | | | | | |
| | | | | SM5796 | | | | | | | | | | | | | | | | | | | | | | | | | | | | | | | | | | | |



Suzuki

| MODEL FAHRZEUG MODELE | YEAR JAHR ANNEE | FRONT/VORNE/AVANT | | | REAR/HINTEN/ARRIERE | | |
|---|------------------------|-----------------------------|-----------------------------|--------------------------------|-----------------------------|-----------------------------|--------------------------------|
| | | PREMIUM Twin-tube Oil | EXCEL-G Twin-tube Gas | GAS-A-JUST Mono-tube Gas | PREMIUM Twin-tube Oil | EXCEL-G Twin-tube Gas | GAS-A-JUST Mono-tube Gas |
| Suzuki (J) | | | | | | | |
| Liana | | | | | | | |
| (ER) Exc. 1.4 DDiS, | 7.01 - | | 333355 L 333354 R | | 333357 L 333356 R | | |
| | | 910143 | SM5487 | | 910143 | | |
| 1.4 DDiS | (ER) 4.04 - | | 333432 L 333431 R | | 333357 L 333356 R | | |
| | | 910143 | SM5740 | | 910143 | | |
| Santana SE416 Vitara (: VSEOSJ ..., VSEE TV/TW ...) | | | | | | | |
| 1.6 (JJ/JV61, TV0) 1.6 (TW0) Incl. ABS | 89 - 89 - | 634073 L 634072 R | 334140 L 334139 R | | 343247 | 553158 | |
| | | | SM5082 | | | | |
| Splash | | | | | | | |
| 1.0, 1.2, 1.2 VVT, 1.3 CDTi | (EX) 9.07 - | | 333409 L 333408 R | | 343420 | | |
| | | 912027 912052 | SM3703 | | SM9930 | | |
| Swift (83-89) | | | | | | | |
| 1000 (AA41 : SA 310) 1300 (AA51 : SA 413) | 10.83 - 10.86 | | | | 442028 | | |
| 1000 (AA43 : SA 310) 1300 (AA53 : SA 413) Gti / Gxi (AA33 : SA 413) | 10.86 - 89 | | | | 441059 | | |
| | | | SM5108 | | SM5189 | | |
| Swift (: = TSMM ...) | | | | | | | |
| 1.0 (AA 44/AB 44, AH 44 : SF 310) 1.3 (AA 35/AB 35, AH 35 : SF 413) 1.6 (: SF4 16) | 92 - | 633134 L 633133 R | 333195 L 333194 R | | 633174 | 333196 | |
| | | 910083 | | | | | |
| Swift (: = JSAE ...) | | | | | | | |
| 1.0 (AA 44/AB 44, AH 44 : SF 310) 1.3 (AA 35/AB 35, AH 35 : SF 413) Exc. GTi 00100001 → 00140000 | 1.89 - 92 1.89 - 92 | 632069 L 632068 R | 332053 L 332052 R | | 632067 | 332051 | |
| | | 910083 | SM5188 | | SM5189 | | |
| 1.3 GTi (AA 34 : SF 413) 00100001 → 00104275 | 1.89 - 12.89 | 632069 L 632068 R | 332053 L 332052 R | | 633174 | 333196 | |
| | | 910083 | SM5188 | | SM5189 | | |
| 1.3 GTi (AA 34 : SF 413) 00104276 → 00140000 | 1.90 - 92 | 632062 L 632061 R | 332050 L 332049 R | | 633174 | 333196 | |
| | | 910083 | SM5188 | | SM5189 | | |
| 1.0 (AA 44/AB 44 : SF 310) 1.3 (AA 35/AB 35, AA 34 : SF 413) Incl. GTi 00140001 → | 92 - 92 - | 633134 L 633133 R | 333195 L 333194 R | | 633174 | 333196 | |
| | | 910083 | SM5188 | | SM5189 | | |



| MODEL FAHRZEUG MODELE | YEAR JAHR ANNEE | FRONT/VORNE/AVANT | | | REAR/HINTEN/ARRIERE | |
|--|-----------------------|-----------------------------|-----------------------------|--------------------------------|---|-----------------------------|
| | | PREMIUM Twin-tube Oil | EXCEL-G Twin-tube Gas | GAS-A-JUST Mono-tube Gas | | PREMIUM Twin-tube Oil |
| Suzuki (J) | | | | | | |
| Swift (: = JSAE ...) | | | | | | |
| (4WD) 1.3 (AF 35 : SF 413) No. 00100001 → 00102077 | 1.89 - 90 | 632062 L▼ 632061 R▼ | 332050 L 332049 R | | 632067▼ | 332051 |
| | | 910083 | | | | |
| (4WD) 1.3 (AF 35 : SF 413) No. 00102078 → | 1.91 - | 633134 L 633133 R | 333195 L 333194 R | | 633174▼ | 333196 |
| | | 910083 | | | | |
| (2WD) No. 00107571 → (AH 35 : SF 413) (2WD) No. 00109591 → (AH 14 : SF 416) (4WD) No. 00102383 → (AJ 14 : SF 416) | 1.89 - 90 | 632062 L▼ 632061 R▼ | 332050 L 332049 R | | 633174▼ | 333196 |
| | | 910083 SM5188 | | | SM5189 | |
| (2WD) No. 00107572 → (AH 35 : SF 413) (2WD) No. 00109592 → (AH 14 : SF 416) (4WD) No. 00102384 → (AJ 14 : SF 416) | 90 - | 633134 L 633133 R | 333195 L 333194 R | | 633174▼ | 333196 |
| | | 910083 SM5188 | | | SM5189 | |
| (2WD) 1.3 (AK 35 : SF 413) | 92 - | 633134 L 633133 R | 333195 L 333194 R | | 633174▼ | 333196 |
| | | 910083 SM5188 | | | SM5189 | |
| Swift III | | | | | | |
| 1.3, 1.5 (MZ, EZ) 1.3 DDiS Exc. (4WD) | 2.05 - 9.10 | | 333409 L 333408 R | | | 343420 ¹⁾ |
| | | SM3703 | | | Exc. (RUS) 343464 + (RUS) SM9930 | |
| 1.6 (MZ, EZ) | 5.06 - | | | | | |
| | | SM3703 | | | SM9930 | |
| 1.3 (4WD), 1.5 (4WD) (MZ, EZ) | 2.05 - 9.10 | | 333409 L 333408 R | | | |
| | | SM3703 | | | | |
| 1) Exc. OE = 41800-63J02 | | | | | | |
| Swift IV | | | | | | |
| 1.2, 1.3 DDiS (FZ, NZ) Exc. (4WD) | 10.10 - | | 338065 L 338064 R | | | 343420 |
| | | SM1049 | | | SM9930 | |
| 1.6 (FZ, NZ) | 1.12 - | | | | | |
| | | SM1049 | | | SM9930 | |
| Swift V | | | | | | |
| 1.0 (82 kW), 1.0 SHVS (82 kW) 1.2 (66 kW), 1.2 SHVS (66 kW) Exc. AllGrip, Hybrid | (AZ) 4.17 - | | 3330128 L 3330127 R | | | |

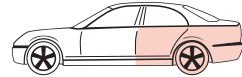
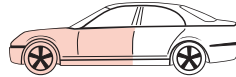

Suzuki

| MODEL FAHRZEUG MODELE | YEAR JAHR ANNEE | FRONT/VORNE/AVANT | | | | REAR/HINTEN/ARRIERE | | | | | | | | | | | | | | | | | | | | | | | |
|--|---|-----------------------------|-----------------------------|--------------------------------|--|-----------------------------|-----------------------------|--------------------------------|--|------------|--------|----|-------|---|-------|-----|----|-----|------|-------|-----|----|-----|--------|-------|-----|----|-----|--------|
| | | PREMIUM Twin-tube Oil | EXCEL-G Twin-tube Gas | GAS-A-JUST Mono-tube Gas | | PREMIUM Twin-tube Oil | EXCEL-G Twin-tube Gas | GAS-A-JUST Mono-tube Gas | | | | | | | | | | | | | | | | | | | | | |
| Suzuki (J) | | | | | | | | | | | | | | | | | | | | | | | | | | | | | |
| SX4 | | | | | | | | | | | | | | | | | | | | | | | | | | | | | |
| 2WD 1.5, 1.5 VVT, 1.6, 1.6 VVT, 1.6 DDiS, 1.9 DDiS Exc. | (GY) 6.06 - | | 333752 L 333751 R | | | 343811 | | | | | | | | | | | | | | | | | | | | | | | |
| | | | 910125 | | | SM5736 | | | | | | | | | | | | | | | | | | | | | | | |
| 4WD 1.6 VVT, 1.9 DDiS Exc. | (GY) 6.06 - | | 333754 L 333753 R | | | 343812 | | | | | | | | | | | | | | | | | | | | | | | |
| | | | 910125 | | | SM5736 | | | | | | | | | | | | | | | | | | | | | | | |
| 2WD 1.5, 1.5 VVT, 1.6, 1.6 VVT | (GY) 6.06 - | | 339314 L 339313 R | | | | | | | | | | | | | | | | | | | | | | | | | | |
| | | | | | | SM5736 | | | | | | | | | | | | | | | | | | | | | | | |
| 4WD 1.6 VVT, 1.9 DDiS, 2.0 | (GY) 6.06 - | | 339314 L 339313 R | | | | | | | | | | | | | | | | | | | | | | | | | | |
| | | | | | | SM5736 | | | | | | | | | | | | | | | | | | | | | | | |
| 2WD 4WD 2.0 DDiS | (GY) 7.09 - | | | | | | | | | | | | | | | | | | | | | | | | | | | | |
| | | | 910125 | | | | | | | | | | | | | | | | | | | | | | | | | | |
| SX4 S-Cross | | | | | | | | | | | | | | | | | | | | | | | | | | | | | |
| 1.0, 1.0 AllGrip, 1.4 T, 1.4 T AllGrip 1.6 (85 kW), 1.6 AllGrip (85 kW) 1.6 DDiS, 1.6 DDiS AllGrip | (JY) 8.13 - | | 3358008 L 3358007 R | | | 3438005 | | | | | | | | | | | | | | | | | | | | | | | |
| Vitara (No. JSAE TA/TD ..., 2S3TA ...), | | | | | | | | | | | | | | | | | | | | | | | | | | | | | |
| 1.6 (TA0 : SE 416) 1.6 (TD0 : SE 416) → TA/TD 0##01110000 | 89 - 95 91 - 95 | 634073 L 634072 R | 334140 L 334139 R | | | 343247 | 553158 | | | | | | | | | | | | | | | | | | | | | | |
| | | | | | | SM5082 | | | | | | | | | | | | | | | | | | | | | | | |
| 1.6 Incl. ABS (TA0 : SE 416) 1.6 Incl. ABS (TD0 : SE 416) TA/TD 0##01110001 → | 96 - | 634073 L 634072 R | 334140 L 334139 R | | | 343247 | 553158 | | | | | | | | | | | | | | | | | | | | | | |
| | | | | | | SM5082 | | | | | | | | | | | | | | | | | | | | | | | |
| 1.9 D, 1.9 TD 2.0 V6 Incl. ABS (TD1 : SV620) 2.0 TD Incl. ABS (TD3 : SV420 D) | 96 - | 634073 L 634072 R | 334140 L 334139 R | | | 343247 | 553158 | | | | | | | | | | | | | | | | | | | | | | |
| | | | | | | SM5082 | | | | | | | | | | | | | | | | | | | | | | | |
| Vitara (LY) | | | | | | | | | | | | | | | | | | | | | | | | | | | | | |
| 1.4 T, 1.4 T AllGrip, 1.6, 1.6 AllGrip 1.6 DDiS, 1.6 DDiS AllGrip | (LY) 2.15 - | | 3358008 L 3358007 R | | | 3438005 | | | | | | | | | | | | | | | | | | | | | | | |
| Wagon R | | | | | | | | | | | | | | | | | | | | | | | | | | | | | |
| 1.0, 1.2 | (RB_) 7.03 - 8.05 | | | | | | | | | | | | | | | | | | | | | | | | | | | | |
| | | | | | | SM1035 ¹⁾ | | | | | | | | | | | | | | | | | | | | | | | |
| 1) | <table border="1"> <thead> <tr> <th>Model Code</th> <th>Stroke</th> <th>kW</th> <th>Drive</th> <th># </th> </tr> </thead> <tbody> <tr> <td>RB310</td> <td>1.0</td> <td>39</td> <td>2WD</td> <td>G10A</td> </tr> <tr> <td>RB310</td> <td>1.0</td> <td>44</td> <td>2WD</td> <td>Z10EXP</td> </tr> <tr> <td>RB412</td> <td>1.2</td> <td>59</td> <td>2WD</td> <td>Z12EXP</td> </tr> </tbody> </table> | | | | | | | | | Model Code | Stroke | kW | Drive | # | RB310 | 1.0 | 39 | 2WD | G10A | RB310 | 1.0 | 44 | 2WD | Z10EXP | RB412 | 1.2 | 59 | 2WD | Z12EXP |
| Model Code | Stroke | kW | Drive | # | | | | | | | | | | | | | | | | | | | | | | | | | |
| RB310 | 1.0 | 39 | 2WD | G10A | | | | | | | | | | | | | | | | | | | | | | | | | |
| RB310 | 1.0 | 44 | 2WD | Z10EXP | | | | | | | | | | | | | | | | | | | | | | | | | |
| RB412 | 1.2 | 59 | 2WD | Z12EXP | | | | | | | | | | | | | | | | | | | | | | | | | |



| MODEL FAHRZEUG MODELE | YEAR JAHR ANNEE | FRONT/VORNE/AVANT | | | | REAR/HINTEN/ARRIERE | | | | | | | | | | | | | | | | | | | | | | | | | | | | | | | | | |
|--|------------------------|-----------------------------|-----------------------------|--------------------------------|--|-----------------------------|-----------------------------|--------------------------------|--|------------|--------|----|-------|---|-------|-----|----|-----|-------|-------|-----|----|-----|-------|-------|----------|----|-----|------|-------|----------|----|-----|------|-------|----------|----|-----|-------|
| | | PREMIUM Twin-tube Oil | EXCEL-G Twin-tube Gas | GAS-A-JUST Mono-tube Gas | | PREMIUM Twin-tube Oil | EXCEL-G Twin-tube Gas | GAS-A-JUST Mono-tube Gas | | | | | | | | | | | | | | | | | | | | | | | | | | | | | | | |
| Suzuki (J) | | | | | | | | | | | | | | | | | | | | | | | | | | | | | | | | | | | | | | | |
| Wagon R+ | | | | | | | | | | | | | | | | | | | | | | | | | | | | | | | | | | | | | | | |
| (2WD) (4WD) 1.0 (SR410 : MA61) 1.2 (SR412 : MA81, MB81) Incl. ABS | 97 - 5.00 98 - 5.00 | | 332093 L 332092 R | | | | 342020 | | | | | | | | | | | | | | | | | | | | | | | | | | | | | | | | |
| | | | SM5108 | | | | | | | | | | | | | | | | | | | | | | | | | | | | | | | | | | | | |
| (2WD) 1.3, 1.3 DDiS (RB413 : MA53) Incl. ABS Exc. (4WD) | 5.00 - | | 333307 L 333306 R | | | | 343331 | | | | | | | | | | | | | | | | | | | | | | | | | | | | | | | | |
| | | 910073 | SM1035 ¹⁾ | | | | | | | | | | | | | | | | | | | | | | | | | | | | | | | | | | | | |
| 1) <table border="1"> <thead> <tr> <th>Model Code</th> <th>Stroke</th> <th>kW</th> <th>Drive</th> <th># </th> </tr> </thead> <tbody> <tr> <td>RB413</td> <td>1.3</td> <td>56</td> <td>2WD</td> <td>G13BB</td> </tr> <tr> <td>RB413</td> <td>1.3</td> <td>56</td> <td>4WD</td> <td>G13BB</td> </tr> <tr> <td>RB413</td> <td>1.3 VVTi</td> <td>69</td> <td>2WD</td> <td>M13A</td> </tr> <tr> <td>RB413</td> <td>1.3 VVTi</td> <td>69</td> <td>4WD</td> <td>M13A</td> </tr> <tr> <td>RB413</td> <td>1.3 DDiS</td> <td>51</td> <td>2WD</td> <td>Z13DT</td> </tr> </tbody> </table> | | | | | | | | | | Model Code | Stroke | kW | Drive | # | RB413 | 1.3 | 56 | 2WD | G13BB | RB413 | 1.3 | 56 | 4WD | G13BB | RB413 | 1.3 VVTi | 69 | 2WD | M13A | RB413 | 1.3 VVTi | 69 | 4WD | M13A | RB413 | 1.3 DDiS | 51 | 2WD | Z13DT |
| Model Code | Stroke | kW | Drive | # | | | | | | | | | | | | | | | | | | | | | | | | | | | | | | | | | | | |
| RB413 | 1.3 | 56 | 2WD | G13BB | | | | | | | | | | | | | | | | | | | | | | | | | | | | | | | | | | | |
| RB413 | 1.3 | 56 | 4WD | G13BB | | | | | | | | | | | | | | | | | | | | | | | | | | | | | | | | | | | |
| RB413 | 1.3 VVTi | 69 | 2WD | M13A | | | | | | | | | | | | | | | | | | | | | | | | | | | | | | | | | | | |
| RB413 | 1.3 VVTi | 69 | 4WD | M13A | | | | | | | | | | | | | | | | | | | | | | | | | | | | | | | | | | | |
| RB413 | 1.3 DDiS | 51 | 2WD | Z13DT | | | | | | | | | | | | | | | | | | | | | | | | | | | | | | | | | | | |
| X-90 | | | | | | | | | | | | | | | | | | | | | | | | | | | | | | | | | | | | | | | |
| 1.6 (2WD) (LA 1) 1.6 (4WD) (LB 1) Incl. ABS | 96 - 96 - | 634073 L 634072 R | 334140 L 334139 R | | | | 343247 | 553158 | | | | | | | | | | | | | | | | | | | | | | | | | | | | | | | |
| | | | SM5082 | | | | | | | | | | | | | | | | | | | | | | | | | | | | | | | | | | | | |
| Suzuki Commercial (J) | | | | | | | | | | | | | | | | | | | | | | | | | | | | | | | | | | | | | | | |
| Carry | | | | | | | | | | | | | | | | | | | | | | | | | | | | | | | | | | | | | | | |
| Super Carry (SK 410 V) | 4.85 - 1.99 | | | | | | 442028 | | | | | | | | | | | | | | | | | | | | | | | | | | | | | | | | |
| Talbot (F) (GB) | | | | | | | | | | | | | | | | | | | | | | | | | | | | | | | | | | | | | | | |
| Alpine | | | | | | | | | | | | | | | | | | | | | | | | | | | | | | | | | | | | | | | |
| | 7.75 - 80 | 443114 | | | | | | | | | | | | | | | | | | | | | | | | | | | | | | | | | | | | | |
| Horizon | | | | | | | | | | | | | | | | | | | | | | | | | | | | | | | | | | | | | | | |
| | 77 - 86 | 443131 | | | | 443130 | | | | | | | | | | | | | | | | | | | | | | | | | | | | | | | | | |
| Samba | | | | | | | | | | | | | | | | | | | | | | | | | | | | | | | | | | | | | | | |
| | 82 - | | | | | 441041 | | | | | | | | | | | | | | | | | | | | | | | | | | | | | | | | | |
| Simca | | | | | | | | | | | | | | | | | | | | | | | | | | | | | | | | | | | | | | | |
| Simca 1307/1308/1309 | 75 - 80 | 443114 | | | | | | | | | | | | | | | | | | | | | | | | | | | | | | | | | | | | | |
| Solara | | | | | | | | | | | | | | | | | | | | | | | | | | | | | | | | | | | | | | | |
| | 80 - | 443131 | | | | 443130 | | | | | | | | | | | | | | | | | | | | | | | | | | | | | | | | | |
| Tagora | | | | | | | | | | | | | | | | | | | | | | | | | | | | | | | | | | | | | | | |
| | 80 - 85 | 664008 | | | | 444036 | | | | | | | | | | | | | | | | | | | | | | | | | | | | | | | | | |

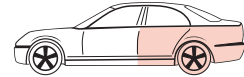
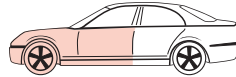

| MODEL FAHRZEUG MODELE | YEAR JAHR ANNEE | FRONT/VORNE/AVANT | | | | REAR/HINTEN/ARRIERE | | | |
|---|-----------------------|--|-----------------------------|--------------------------------|--|-----------------------------|-----------------------------|--------------------------------|--|
| | | PREMIUM Twin-tube Oil | EXCEL-G Twin-tube Gas | GAS-A-JUST Mono-tube Gas | | PREMIUM Twin-tube Oil | EXCEL-G Twin-tube Gas | GAS-A-JUST Mono-tube Gas | |
| Toyota (J) | | | | | | | | | |
| Aurion | | | | | | | | | |
| 3.5 | (GSV50) | 9.11 - | | 339352 L 339351 R | | | | | |
| Auris | | | | | | | | | |
| 1.3 1.4 L 1.6 L 1.8 2.0 L Exc. 1.8 Hybrid, 2.2 D | (_E15_) | 10.06 - | | 339701 L 339700 R | | | 344811 | | |
| | | | | 910079 SM1009 ¹⁾ | | | 912030 SM9911 | | |
| 1.8 Hybrid, 2.2 D | (_E15_) | 3.07 - | | | | | | | |
| | | | | 910079 | | | | | |
| 1.3, 1.4 D-4D Incl. | (E18) | 10.12 - | | 339701 L 339700 R | | | 3448008 | | |
| | | | | SM5639 ²⁾ | | | 912030 SM9911 | | |
| 1.6, 2.0 D-4D Incl. | (E18) | 10.12 - | | 339701 L 339700 R | | | 3448009 | | |
| | | | | SM5639 ²⁾ | | | 912030 SM9911 | | |
| 1.2, 1.6 D-4D Incl. | (E18) | 3.15 - | | 3358012 L 3358011 R | | | 3448009 | | |
| | | | | SM5639 ²⁾ | | | 912030 SM9911 | | |
| 1.8 Hybrid Incl. | (E18) | 10.12 - | | 339701 L 339700 R | | | 3448009 | | |
| | | | | SM5639 ²⁾ | | | 912030 SM9911 | | |
| 1) Exc. 2.0 D-4D 2) Exc. 2.0 D-4D | | | | | | | | | |
| Auris Touring Sports | | | | | | | | | |
| 1.3, 1.4 D-4D | (E18) | 7.13 - | | 339701 L 339700 R | | | 3448008 | | |
| | | | | SM5639 ¹⁾ | | | 912030 | | |
| 1.6, 1.8 Hybrid, 2.0 D-4D | (E18) | 7.13 - | | 339701 L 339700 R | | | 3448009 | | |
| | | | | SM5639 ¹⁾ | | | 912030 | | |
| 1.2, 1.6 D-4D Incl. | (E18) | 3.15 - | | 3358012 L 3358011 R | | | 3448009 | | |
| | | | | SM5639 ¹⁾ | | | 912030 | | |
| 1) | | | | | | | | | |
| Avensis (_T22_) | | | | | | | | | |
| 1.6, 1.8, 2.0 (AT220, AT221, ST220) 2.0 Diesel Turbo (CT220) 1.9 D, 2.0 D | | 10.97 - 7.00 10.97 - 7.00 10.97 - 2.03 | | 334204 L 334203 R | | | 334330 L 334329 R | | |
| | | | | 913267 | | | 910084 SM5087 | | |
| 2.0 D | (_T22_) | 9.02 - 2.03 | | | | | | | |
| | | | | | | | 910085 | | |



| MODEL FAHRZEUG MODELE | YEAR JAHR ANNEE | FRONT/VORNE/AVANT | | | | REAR/HINTEN/ARRIERE | | | |
|--|-----------------------|-----------------------------|-----------------------------|--------------------------------|----------------------|-----------------------------|-----------------------------|--------------------------------|--------|
| | | PREMIUM Twin-tube Oil | EXCEL-G Twin-tube Gas | GAS-A-JUST Mono-tube Gas | | PREMIUM Twin-tube Oil | EXCEL-G Twin-tube Gas | GAS-A-JUST Mono-tube Gas | |
| Toyota (J) | | | | | | | | | |
| Avensis (_T22_) | | | | | | | | | |
| 1.6 VVTi (ZZT220) 1.8 VVTi (ZZT221) 2.0 VVTi (AZT220) 2.0 D-4D (CDT220) | 7.00 - 12.02 | | 334204 L 334203 R | | | 334330 L 334329 R | | | |
| | | | 913267 | | | | 910084 | | SM5087 |
| Avensis (_T25_) | | | | | | | | | |
| 1.6 VVTi (ZZT250) 1.8 (ZZT251) 2.0, 2.0 VVTi (AZT250) Exc. , , Turkey spec., | 1.03 - 12.09 | | 334816 L 334815 R | | | | | | |
| | | | 910049 | | SM1010 | | 910054 | | SM9917 |
| 1.6 VVTi (ZZT250) 1.8 (ZZT251) 2.0, 2.0 VVTi (AZT250) 2.4 (AZT251) 2.0 D-4D (CDT250) 2.2 D-4D, 2.2 D-CAT (ADT251) Incl. , , Turkey spec., | 1.03 - 6.03 | | | | | 341815 | | | |
| | | | 910049 | | SM1010 | | 910054 | | SM9917 |
| 1.6 VVTi (ZZT250) 1.8 (ZZT251) 2.0, 2.0 VVTi (AZT250) 2.4 (AZT251) 2.0 D-4D (CDT250) 2.2 D-4D, 2.2 D-CAT (ADT251) Exc. , , Turkey spec., | 6.03 - 4.06 | | | | | 341815 | | | |
| | | | 910049 | | SM1010 | | 910054 | | SM9917 |
| 1.6 VVTi (ZZT250) 1.8 (ZZT251) 2.0, 2.0 VVTi (AZT250) 2.4 (AZT251) 2.0 D-4D (CDT250) 2.2 D-4D, 2.2 D-CAT (ADT251) , Turkey spec., | 6.03 - 12.09 | | | | | 341815 | | | |
| | | | 910049 | | SM1010 | | 910054 | | SM9917 |
| Avensis (_T27_) | | | | | | | | | |
| Exc. | (_T27_) 11.08 - 1.11 | | 339817 L 339816 R | | | 349248 | | | |
| | | | | | SM1011 ¹⁾ | | 912030 | | |
| Exc. | (_T27_) 2.11 - | | 339817 L 339816 R | | | 3448019 | | | |
| | | | | | SM1011 ¹⁾ | | 912030 | | |
| 1.6, 1.8, 2.0 (= 3ZRFAE) (_T27_) 2.0 D-4D (91 kW, 93 kW), 2.2 D-4D | 11.08 - 7.10 | | 3358010 L▼ 3358009 R▼ | | | | | | |
| | | | | | SM1011 ¹⁾ | | 912030 | | |
| 2.0 (= 3ZRFE) (_T27_) | 11.08 - | | 339817 L 339816 R | | | 3448019 | | | |
| | | | | | SM1011 ¹⁾ | | 912030 | | |

1) → 5.15



Toyota

| MODEL FAHRZEUG MODELE | YEAR JAHR ANNEE | FRONT/VORNE/AVANT | | | | REAR/HINTEN/ARRIERE | | | |
|--|-----------------------|-----------------------------|--|--------------------------------|--|-----------------------------|--|--------------------------------|--|
| | | PREMIUM Twin-tube Oil | EXCEL-G Twin-tube Gas | GAS-A-JUST Mono-tube Gas | | PREMIUM Twin-tube Oil | EXCEL-G Twin-tube Gas | GAS-A-JUST Mono-tube Gas | |
| Toyota (J) | | | | | | | | | |
| Avensis Verso | | | | | | | | | |
| 2.0 (ACM20) 2.0 D (CLM20) | 8.01 - 11.09 | | 334320 L 334319 R | | | | 344362 | | |
| | | | 910145 | | | | 912029 | | |
| Aygo | | | | | | | | | |
| 1.0 i, 1.0 LPG, 1.4 HDi (WNB1_, KGB1_) | 2.05 - | | 332808 L ¹⁾ 332807 R ¹⁾ | | | | 343808 | | |
| | | | 910123 SM1930 | | | | 912023 SM9913 | | |
| ALL (PAB4_, KGB4_) Incl. H/D, Panorama Sunroof | 5.14 - | | 332808 L 332807 R | | | | 343808 | | |
| | | | 910123 SM1930 | | | | 912023 SM9913 | | |
| 1) → 2.12 | | | | | | | | | |
| Blizzard | | | | | | | | | |
| LD 10, LD 10 V | 3.80 - 5.84 | 443152 | | | | 443150 | | 553143 | |
| Camry | | | | | | | | | |
| (SV10, CV10, SV11) 1800, 2000, 2000 Diesel | 3.82 - 7.86 | 665046▼ | | | | | 333012 L▼ 333011 R▼ | | |
| | | | | | | | | SM5069 | |
| 2WD (SV20, SV21, CV20, VZV21) 1800, 2000 i, 2000 TD, 2500-V6 | 10.86 - 91 | | 365061 | | | | 365062 | | |
| | | | 910084 SM5090 | | | | 910084 SM5375▼ | | |
| 4WD (SV25) 2000 i | 8.88 - 91 | | 365061 | | | | 334055 L▼ 334054 R▼ | | |
| | | | 910084 | | | | | | |
| (SV20, SV21, CV20, VZV21) 1800, 2000 i, 2000 TD, 2500-V6 | 10.86 - 92 | | 365061 | | | | 365063 | | |
| | | | 910084 SM5090 | | | | | SM5375▼ | |
| (SXV10, VCV10) 2200, 3000 | 6.91 - 8.94 | | 365085 ¹⁾ 334477 L 334476 R | | | | 365097 ¹⁾ 334479 L 334478 R | | |
| | | | | | | | | SM5133▼ | |
| (SXV10, VCV10) 2200, 3000 | 8.94 - 8.96 | | 365096 ¹⁾ 334171 L 334170 R | | | | 365097 ¹⁾ 334479 L 334478 R | | |
| | | | | | | | | SM5133▼ | |
| (SXV10, VCV10) 2200, 3000 | 3.92 - 8.94 | | 334477 L 334476 R | | | | 334479 L 334478 R | | |
| | | | | | | | | SM5133▼ | |
| (SXV10, VCV10) 2200, 3000 | 8.94 - 7.96 | | 334171 L 334170 R | | | | 334479 L 334478 R | | |
| | | | | | | | | SM5133▼ | |

1)



| MODEL FAHRZEUG MODELE | YEAR JAHR ANNEE | FRONT/VORNE/AVANT | | | | REAR/HINTEN/ARRIERE | | | |
|---|-----------------------------|-----------------------------|--|--------------------------------|--|-----------------------------|--|--------------------------------|--|
| | | PREMIUM Twin-tube Oil | EXCEL-G Twin-tube Gas | GAS-A-JUST Mono-tube Gas | | PREMIUM Twin-tube Oil | EXCEL-G Twin-tube Gas | GAS-A-JUST Mono-tube Gas | |
| Toyota (J) | | | | | | | | | |
| Camry | | | | | | | | | |
| (SXV20, MCV20) 2200, 3000 | 8.96 - 7.01 | | 339087 L 339086 R | | | | 334479 L 334478 R | | |
| | | 910168 | SM5180 L▼ SM5179 R▼ | | | 935313 | SM5175 | | |
| 2.0 i (ACV31) 2.4 (ACV30) 3.0 i (MCV30) | 8.01 - 7.03 | | 334339 L 334338 R 324047 L 324046 R | | | | 334341 L 334340 R 324049 L 324048 R | | |
| | | | SM5423 | | | 935313 | SM5175 | | |
| 2.0 i (ACV31) 2.4 (ACV30) 3.0 i (MCV30) | 8.03 - 1.06 | | 334387 L 334386 R | | | | 334389 L 334388 R | | |
| | | | SM5423 | | | 935313 | SM5175 | | |
| (XV4) 2.4 i 16V LE 2.4 i Auto 16V LE, 2.4 VVTi, 3.5 i V6 | 1.06 - 9.11 | | 339024 L 339023 R | | | | 339026 L 339025 R | | |
| | | | SM5637 | | | 935313 | | | |
| 2.0 (109 kW) (ACV51_) 2.5 Altise (ASV50_) 3.5 (183 kW, 204 kW) (GSV50_) | 9.11 - | | 339352 L 339351 R | | | | | | |
| Carina | | | | | | | | | |
| (TA/RA 10/30 series) 1400, 1600, 1800, 2000 | 2.70 - 9.77 | 665021 | | | | | 343036 | | |
| (TA 16 V/19 V/49 V) 1400, 1600 | 1.76 - 8.81 | 665021 | | | | 443098 | | | |
| 1600, 1800, 2000 (TA 41/45/46/47, RA 45/46) 1500, 1800 (AA 60, SA 60, CA 60, TA 60/62) | 10.77 - 7.81 8.81 - 8.85 | 665021 | | | | 443102 | 343039 | | |
| (TA 61/63, RA 63) 1600, 1800, 2000 | 8.81 - 8.85 | 665024▼ | | | | | 343042 | | |
| (TA 67 V, CA 67 V) 1600, 1800 Diesel | 9.81 - 9.83 | 665021 | | | | | | | |
| (SA 60 G) 1800 | 2.82 - 8.85 | 665021 | | | | 443102 | 343039 | | |
| Carina II (Corona) | | | | | | | | | |
| (ST 150, CT 150) 1800 | 2.83 - 4.85 | 665047▼ | 365041 | | | | 333003 L▼ 333002 R▼ | | |
| | | 913267 | | | | 913128▼ 910085 | | | |
| (AT 151) 1600 | 5.85 - 11.87 | | 363059 | | | | 333003 L▼ 333002 R▼ | | |
| | | 913267 | SM5019▼ | | | 913128▼ 910085 | | | |



| MODEL FAHRZEUG MODELE | YEAR JAHR ANNEE | FRONT/VORNE/AVANT | | | REAR/HINTEN/ARRIERE | | |
|-----------------------------|-----------------------|-----------------------------|-----------------------------|--------------------------------|-----------------------------|-----------------------------|--------------------------------|
| | | PREMIUM Twin-tube Oil | EXCEL-G Twin-tube Gas | GAS-A-JUST Mono-tube Gas | PREMIUM Twin-tube Oil | EXCEL-G Twin-tube Gas | GAS-A-JUST Mono-tube Gas |

Toyota (J)

Carina II (Corona)

| | | | | | | | | |
|-----------------------|------------------|--------------|------------|--------------|--|--|----------------------------|------------|
| 1800, 2000 Diesel | (ST 150, CT 150) | 5.85 - 11.87 | | 365058 | | | 333003 L ▼ 333002 R ▼ | |
| | | | ☞☞☞ 913267 | ☞☞☞ SM5019 ▼ | | | ☞☞☞ 913128 ▼ ☞☞☞ 910085 | |
| 1600, 1600 i | (AT 171) | 12.87 - 3.92 | | 363062 | | | | |
| | | | ☞☞☞ 913267 | | | | ☞☞☞ 910085 | ☞☞☞ SM5087 |
| 2000 i | (ST 171) | 12.87 - 3.92 | | 365068 | | | 334028 L 334027 R | |
| | | | ☞☞☞ 913267 | | | | ☞☞☞ 910085 | ☞☞☞ SM5087 |
| 2000 Diesel | (CT 170) | 12.87 - 3.92 | | 365068 | | | | |
| | | | ☞☞☞ 913267 | | | | ☞☞☞ 910085 | ☞☞☞ SM5087 |

Carina E (📦 : 🚗 = JT ...)

| | | | | | | | | |
|--|----------|-------------|------------|----------------------|--|--|----------------------|--|
| 1.6 Incl. ABS Exc. Rough road package | (AT 190) | 2.92 - 1.96 | | 333198 L 333197 R | | | 333108 L 333107 R | |
| | | | ☞☞☞ 913267 | | | | ☞☞☞ 910085 | |
| 1.6 ⊕ Rough road package Incl. ABS | (AT 190) | 2.92 - 1.96 | | 333198 L 333197 R | | | 333113 L 333112 R | |
| | | | ☞☞☞ 913267 | | | | ☞☞☞ 910085 | |
| 2.0 D, 2.0 TD Incl. ABS Exc. Rough road package | (CT 190) | 2.92 - 1.96 | | 365081 | | | 333108 L 333107 R | |
| | | | ☞☞☞ 913267 | | | | ☞☞☞ 910085 | |
| 2.0 D, 2.0 TD ⊕ Rough road package Incl. ABS | (CT 190) | 2.92 - 1.96 | | 365081 | | | 333113 L 333112 R | |
| | | | ☞☞☞ 913267 | | | | ☞☞☞ 910085 | |
| 2.0 i Incl. ABS Exc. GTi, Rough road package | (ST191) | 2.92 - 1.96 | | 365081 | | | 334064 L 334063 R | |
| | | | ☞☞☞ 913267 | | | | ☞☞☞ 910085 | |
| 2.0 i ⊕ Rough road package Incl. ABS Exc. GTi | (ST191) | 2.92 - 1.96 | | 365081 | | | 334062 L 334061 R | |
| | | | ☞☞☞ 913267 | | | | ☞☞☞ 910085 | |
| 2.0 GTi Incl. ABS | (ST191) | 2.92 - 1.96 | | | | | 334064 L 334063 R | |
| | | | | | | | ☞☞☞ 910085 | |

Carina E (📦 : 🚗 = JT ...)

| | | | | | | | | |
|------------------------------|----------------------|------------------------------|------------|----------------------|--|--|----------------------|--|
| 1.6 i 1.8 i Incl. ABS | (AT 190) (AT 191) | 11.92 - 1.96 2.94 - 1.96 | | 333198 L 333197 R | | | 333113 L 333112 R | |
| | | | ☞☞☞ 913267 | | | | ☞☞☞ 910085 | |
| 2.0 D 2.0 TD Incl. ABS | (CT 190) (CT 190) | 11.92 - 1.96 11.92 - 1.96 | | 365081 | | | 333113 L 333112 R | |
| | | | ☞☞☞ 913267 | | | | ☞☞☞ 910085 | |
| 2.0 i Incl. ABS | (ST 191) | 11.92 - 1.96 | | 365081 | | | 334062 L 334061 R | |
| | | | ☞☞☞ 913267 | | | | | |



| MODEL FAHRZEUG MODELE | YEAR JAHR ANNEE | FRONT/VORNE/AVANT | | | | REAR/HINTEN/ARRIERE | | | |
|--|-----------------------|-----------------------------|-----------------------------|--|------|-----------------------------|-----------------------------|--------------------------------|--|
| | | PREMIUM Twin-tube Oil | EXCEL-G Twin-tube Gas | GAS-A-JUST Mono-tube Gas | | PREMIUM Twin-tube Oil | EXCEL-G Twin-tube Gas | GAS-A-JUST Mono-tube Gas | |
| Toyota (J) | | | | | | | | | |
| Carina E (: = SB ...) | | | | | | | | | |
| 1.6 i Incl. ABS Exc. (IRL) | (AT 190) | 12.92- 8.93 | | 333198 L 333197 R | | | 333108 L 333107 R | | |
| | | | ∞ 913267 | | | | | | |
| (IRL) 1.6 i Incl. ABS | (AT 190) | 12.92- 8.93 | | 333198 L 333197 R | | | 333113 L 333112 R | | |
| | | | ∞ 913267 | | | | | | |
| 1.6 i 1.8 i Incl. ABS Exc. (IRL) | (AT 190) (AT 191) | 8.93- 1.96 | | 334138 L 334137 R | | | 334064 L 334063 R | | |
| | | | ∞ 913267 | | | | | | |
| (IRL) 1.6 i 1.8 i Incl. ABS | (AT 190) (AT 191) | 8.93- 1.96 | | 334138 L 334137 R | | | 334062 L 334061 R | | |
| | | | ∞ 913267 | | | | | | |
| 1.6 i 1.8 i Incl. ABS | (AT 190) (AT 191) | 1.96- 98 1.96- 98 | | 334138 L 334137 R | | | 334062 L 334061 R | | |
| | | | ∞ 913267 | | | | | | |
| 2.0 i 2.0 D, 2.0 TD Incl. ABS Exc. (IRL), GTi | (ST 191) (CT 190) | 12.92- 12.94 8.93- 12.94 | | 365081 ¹⁾ 334138 L ²⁾ 334137 R ²⁾ | | | 334064 L 334063 R | | |
| | | | ∞ 913267 | | | | | | |
| (IRL) 2.0 i 2.0 D, 2.0 TD Incl. ABS Exc. GTi | (ST 191) (CT 190) | 12.92- 12.94 8.93- 12.94 | | 365081 ¹⁾ 334138 L ²⁾ 334137 R ²⁾ | | | 334062 L 334061 R | | |
| | | | ∞ 913267 | | | | | | |
| 2.0 i 2.0 D, 2.0 TD Incl. ABS Exc. (IRL), GTi | (ST 191) (CT 190) | 12.94- 1.96 12.94- 1.96 | | 334138 L 334137 R | | | 334064 L 334063 R | | |
| | | | ∞ 913267 | | | | | | |
| (IRL) 2.0 i 2.0 D, 2.0 TD Incl. ABS Exc. GTi | (ST 191) (CT 190) | 12.94- 1.96 12.94- 1.96 | | 334138 L 334137 R | | | 334062 L 334061 R | | |
| | | | ∞ 913267 | | | | | | |
| 2.0 i 2.0 D, 2.0 TD Incl. ABS Exc. GTi | (ST 191) (CT 190) | 1.96- 98 1.96- 98 | | 334138 L 334137 R | | | 334062 L 334061 R | | |
| | | | ∞ 913267 | | | | | | |

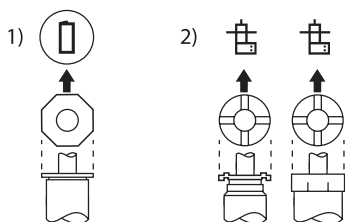



| MODEL FAHRZEUG MODELE | YEAR JAHR ANNEE | FRONT/VORNE/AVANT | | | | REAR/HINTEN/ARRIERE | | | |
|---|----------------------------|-----------------------------|--|--------------------------------|----------------|-----------------------------|-----------------------------|--------------------------------|--|
| | | PREMIUM Twin-tube Oil | EXCEL-G Twin-tube Gas | GAS-A-JUST Mono-tube Gas | | PREMIUM Twin-tube Oil | EXCEL-G Twin-tube Gas | GAS-A-JUST Mono-tube Gas | |
| Toyota (J) | | | | | | | | | |
| Carina E (: = SB ...) | | | | | | | | | |
| 1.6 i (AT 190) 1.8 i (AT 191) 2.0 D, 2.0 TD (CT 190) 2.0 i (ST 191) Incl. ABS | 5.95 - 98 | | 334138 L 334137 R | | | | 334062 L 334061 R | | |
| | | 913267 | | | | | | | |
| Celica | | | | | | | | | |
| 1600, 2000 (TA 20, RA 20 series) | 12.70 - 9.75 | | 365022 | | | | 343036 | | |
| 1600, 1200 (TA 23/28/35, RA 23/28/35) | 10.75 - 8.77 | 665021 | | | | | 343036 | | |
| 1600, 1800, 2000 (TA 45/46/47, RA 45) ⊕ | 10.77 - 7.80 | 665021 | | | | | 343039 | | |
| 1600, 2000, 2600 (TA 40, RA 40, MA 45/46) ⊕ | 10.77 - 7.80 | 665024▼ | | | | | 343039 | | |
| 1600, 1800, 2000, 2800 (TA 55/61/63, RA 55/63, MA 55/56) | 8.80 - 7.81 | 665024▼ | | | | | 343042 | | |
| 1.6 (TA60) | 8.81 - 7.85 | 665021 | | | | 443102 | 343039 | | |
| 2.0 ST, XT (RA 60) | 8.81 - 7.85 | 665024▼ | | | | 443102 | 343039 | | |
| 1.6 GT, GTS (AA63) 2.0 XT, ST, GT (RA61/63/65, SA63) | 8.83 - 7.85 8.81 - 1.85 | 665024▼ | | | | | 343042 | | |
| ST, GT (AT 160, ST 162, ST 160) Exc. ST 165 | 8.85 - 8.87 | | 365058 ¹⁾ 365068 ²⁾ | | | | | | |
| | | 916902 SM5086 | | | 910085 SM5069 | | | | |
| GT (AT 160, ST 160) Exc. ST 165 | 8.87 - 9.89 | | 365058 ¹⁾ 365068 ²⁾ | | | | 334014 L 334013 R | | |
| | | 916902 SM5086 | | | 910085 SM5069 | | | | |
| 1.6 STi (AT 180) 2.0 GTi (ST 182) | 10.89 - 94 | | 365077 | | | | 334051 L 334050 R | | |
| | | SM5086 | | | SM5087 | | | | |
| 2.0 Turbo (ST 185) | 10.89 - 94 | | 365077 | | | | 334053 L 334052 R | | |
| 1.8 (AT 200) 2.0 (ST 202) Exc. Super Strut sus. | 94 - 99 | | 365092 ³⁾ 334379 L ⁴⁾ 334378 R ⁴⁾ | | | | 334126 L 334125 R | | |
| | | SM5164 | | | SM5087 | | | | |
| 2.0 (ST 202) 2.0 GT Four (ST 205) ⊕ Super Strut sus. | 94 - 99 | | 331019 L ⁵⁾ 331018 R ⁵⁾ | | | | 334128 L 334127 R | | |



| MODEL FAHRZEUG MODELE | YEAR JAHR ANNEE | FRONT/VORNE/AVANT | | | | REAR/HINTEN/ARRIERE | | | |
|---|-----------------------|-----------------------------|-----------------------------|--------------------------------|--|-----------------------------|-----------------------------|--------------------------------|--|
| | | PREMIUM Twin-tube Oil | EXCEL-G Twin-tube Gas | GAS-A-JUST Mono-tube Gas | | PREMIUM Twin-tube Oil | EXCEL-G Twin-tube Gas | GAS-A-JUST Mono-tube Gas | |
| Toyota (J) | | | | | | | | | |
| Celica | | | | | | | | | |
| 1.8 (ZZT230) | 8.99 - 10.99 | | 334278 L 334277 R | | | | 341277 ⁶⁾ | | |
| 1.8 (ZZT230) | 10.99 - 8.00 | | 334278 L 334277 R | | | | 341278 ⁷⁾ | | |
| 1.8 (ZZT23#) | 8.00 - | | 334278 L 334277 R | | | | 341278 ⁷⁾ | | |
| | | | | | | | | | |
| Celica Supra, Supra Exc. | | | | | | | | | |
| 2.8 (MA 61) | 12.81 - 8.83 | | 365076 | | | | 343042 | | |
| 2.8 (MA 61) | 9.83 - 12.85 | | | | | | 343042 | | |
| 3.0 24V, 3.0 24V Turbo (MA 70) | 1.86 - 5.93 | | | | | | 341070 | | |
| 3.0 24V, 3.0 24V Turbo (JZA 80) | 5.93 - 1.96 | | | 551069 | | | | 551070 | |
| Corolla & Sprinter (70-4.87) | | | | | | | | | |
| (KE 20, TE 20 series) 1200, 1400 | 5.70 - 3.74 | 663031 | 363018 | | | | | | |
| (KE 26 V) 1200 | 5.70 - 3.74 | 663031 | | | | | | | |
| (TE 27 MQ, 27 MBQ) 1600 SR | 3.72 - 3.74 | 665021 | | | | | | | |
| (KE 30, 40, 50, 60) 1200, 1300 | 4.74 - 5.79 | 663031 | 363018 | | | | | 553055 | |
| (TE 30, 40, 50, 60) 1400, 1600 | 4.74 - 5.79 | 665022▼ | 365015 | | | | | 553055 | |
| (KE 36 V) 1200 | 4.74 - 5.79 | 663031 | 363018 | | | 443098 | | | |
| (TE 36 V) 1400 | 4.74 - 5.79 | 665022▼ | 365015 | | | 443098 | | | |
| (KE 70, AE 70) 1300, 1500 | 6.79 - 6.83 | 663032 | | | | | 343036 | | |

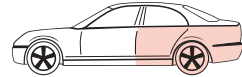
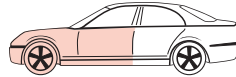

Toyota

| MODEL FAHRZEUG MODELE | YEAR JAHR ANNEE | FRONT/VORNE/AVANT | | | | REAR/HINTEN/ARRIERE | | | |
|-----------------------------|-----------------------|-----------------------------|-----------------------------|--------------------------------|--|-----------------------------|-----------------------------|--------------------------------|--|
| | | PREMIUM Twin-tube Oil | EXCEL-G Twin-tube Gas | GAS-A-JUST Mono-tube Gas | | PREMIUM Twin-tube Oil | EXCEL-G Twin-tube Gas | GAS-A-JUST Mono-tube Gas | |

Toyota (J)

Corolla & Sprinter (70-4.87)

| | | | | | | | | | |
|---|--|---------|---------|--|--|--------|----------------------|--|--|
| (TE 70, TE 71, CE 70) 1600, 1800, 1800 Diesel | 6.79 - 6.83 | 665022▼ | 365015 | | | | 343036 | | |
| 1300 (KE 71 V, 72 V) 1300 (KE 73 G) 1300 (KE70) | 6.79 - 8.81 4.82 - 7.87 12.79 - 8.87 | 663032 | | | | 443098 | | | |
| 1600 (OHC) (TE 73 V) | 6.79 - 8.81 | 665022▼ | 365015 | | | 443098 | | | |
| 1800 Diesel (CE70, CE 71 V) | 8.81 - 7.87 | 665022▼ | 365015 | | | 443098 | | | |
| 1300, 1500, 1600 (AE 80/81/82, EE 80) | 5.83 - 4.85 | 663045 | 363039▼ | | | | 332012 L 332011 R | | |
| | | 916902 | SM5019▼ | | | 910085 | SM5069 | | |
| 1800 Diesel (CE 80) Exc. Rough Road Package () | 5.83 - 4.87 | 665047▼ | 365041 | | | | 332012 L 332011 R | | |
| | | 916902 | SM5019▼ | | | 910085 | SM5069 | | |
| 1600 GT 16V (Levin) (AE 86) 1600 | 5.83 - 4.87 | | 365015 | | | | 343036 | | |
| 1600 Compact GT 16 V (AE 82) | 10.84 - 4.87 | | 365041 | | | | 332021▼ | | |
| | | 916902 | SM5019▼ | | | | SM5069 | | |
| 1300, 1600 (EE 80, AE 80, AE 82, E8B) Exc. GT-16V | 5.85 - 4.87 | | 363059 | | | | 332012 L 332011 R | | |
| | | 916902 | SM5019▼ | | | | SM5069 | | |

Corolla (5.87- 4.97)

| | | | | | | | | | |
|---|-----------|--------|--|--|--|--------|----------------------|--|--|
| (2WD) 1300, 1600 (EE 90, AE 92) Exc. 1600 Gti Exc. Rough Road Package () | 5.87 - 92 | | 363060 ¹⁾ 333119 L 333118 R | | | | 333052 L 333051 R | | |
| | | 916902 | SM5049 | | | 910085 | SM5074 L SM5075 R | | |
| 1600 GTi (AE 92) | 5.87 - 92 | | 365064 | | | | 333052 L 333051 R | | |
| | | 916902 | SM5049 | | | 910085 | SM5074 L SM5075 R | | |
| 1800 Diesel (CE 90) Exc. Rough Road Package () | 5.87 - 92 | | 365064 | | | | 333052 L 333051 R | | |
| | | 916902 | SM5049 | | | 910085 | SM5074 L SM5075 R | | |
| 1300, 1600, 1800 Diesel (EE 90, AE 92, CE 90) ⊕ Rough Road Package () | 5.87 - 92 | | 365066 | | | | 333052 L 333051 R | | |
| | | | | | | 910085 | | | |



| MODEL FAHRZEUG MODELE | YEAR JAHR ANNEE | FRONT/VORNE/AVANT | | | | REAR/HINTEN/ARRIERE | | | |
|-----------------------------|-----------------------|-----------------------------|-----------------------------|--------------------------------|--|-----------------------------|-----------------------------|--------------------------------|--|
| | | PREMIUM Twin-tube Oil | EXCEL-G Twin-tube Gas | GAS-A-JUST Mono-tube Gas | | PREMIUM Twin-tube Oil | EXCEL-G Twin-tube Gas | GAS-A-JUST Mono-tube Gas | |

Toyota (J)

Corolla (5.87- 4.97)

| | | | | | | | | | |
|---|--------------|--|--|----------------|--|--|----------------------|------------------------------|--|
| 1600 (4WD) (AE 95) | 10.87 - 8.95 | | 365066 | | | | 343242 | | |
| 1300 i, 1300 Xli, 1400 i (EE 100, EE 101) Exc. Rough Road Package | 5.92 - 4.97 | | 333115 L 333114 R | 916902 SM5104 | | | 333117 L 333116 R | 910085 SM5074 L SM5075 R | |
| 1600 i (AE 101) | 5.92 - 4.97 | | 333115 L 333114 R | 916902 SM5104 | | | 333117 L 333116 R | 910085 SM5074 L SM5075 R | |
| 2000 Diesel (CE 100) Exc. Rough Road Package | 5.92 - 4.97 | | 365091 ¹⁾ 334177 L ²⁾ 334176 R ²⁾ | 916902 SM5104 | | | 333117 L 333116 R | 910085 SM5074 L SM5075 R | |
| 1300 i, 1300 Xli, 2000 Diesel (EE 100, EE 101, CE 100) ⊕ Rough Road Package | 5.92 - 4.97 | | | | | | 333117 L 333116 R | 910085 | |

1)

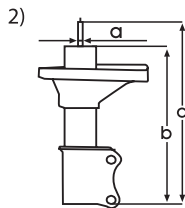

| | a | b | c |
|----------|-------|--------|--------|
| 334177 L | 22 mm | 323 mm | 481 mm |
| 334176 R | | | |

Corolla (No. = JT153..., JTB53...), (No. = JT172..., JTB72...) (4.97-9.01)

| | | | | | | | | | |
|---|-------------|--|--|----------------|--|--|--|------------------------------|--|
| 1300-12V (EE110) Exc. Rough Road Package | 4.97 - 9.01 | | 333237 L ¹⁾ 333236 R ¹⁾ | 916902 SM5104 | | | 332089 L ²⁾ 332088 R ²⁾ | 910085 SM5074 L SM5075 R | |
| 1300-16V, 1600-16V (EE111, AE111) 1400-16V, 1600-16V (ZZE111, ZZE112) Exc. Rough Road Package | 4.97 - 9.01 | | 333237 L ¹⁾ 333236 R ¹⁾ 323064 L 323063 R | 916902 SM5104 | | | 334179 L ²⁾ 334178 R ²⁾ 324045 L 324044 R | 910085 SM5074 L SM5075 R | |

1) ⇔ 2)

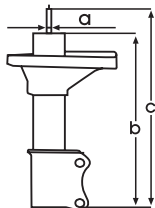

1)

| | a | b | c |
|----------|-------|--------|--------|
| 333237 L | 20 mm | 328 mm | 479 mm |
| 333236 R | | | |

2)

| | a | b | c |
|----------|-------|--------|--------|
| 334179 L | 20 mm | 368 mm | 523 mm |
| 334178 R | | | |



| MODEL FAHRZEUG MODELE | YEAR JAHR ANNEE | FRONT/VORNE/AVANT | | | REAR/HINTEN/ARRIERE | | |
|-----------------------------|-----------------------|-----------------------------|-----------------------------|--------------------------------|-----------------------------|-----------------------------|--------------------------------|
| | | PREMIUM Twin-tube Oil | EXCEL-G Twin-tube Gas | GAS-A-JUST Mono-tube Gas | PREMIUM Twin-tube Oil | EXCEL-G Twin-tube Gas | GAS-A-JUST Mono-tube Gas |

Toyota (J)

Corolla (No. = JT153..., JTB53...), (No. = JT172..., JTB72...) (4.97-9.01)

| | | | | | | | |
|---|-------------|--|--|--|--|--|------|
| 1800 D, 1900 D, 2000 D (WZE110, WZE110, CE 110) Exc. Rough Road Package | 4.97 - 1.02 | | 334177 L ²⁾ 334176 R ²⁾ | | | 334179 L ⁴⁾ 334178 R ⁴⁾ | |
| 1300 (12V, 16V), 1400-16V, 1600-16V 1800 Diesel, 2000 Diesel, 2000 D4D ⊕ Rough Road Package | 4.97 - 9.01 | | 334187 L ³⁾ 334186 R ³⁾ | | | 333117 L ⁵⁾ 333116 R ⁵⁾ | |
| 1800-16V (AE115) | 4.97 - 9.01 | | 334187 L ³⁾ 334186 R ³⁾ | | | 333287 L 333286 R | |

Corolla (4.92-9.01)

| | | | | | | | |
|----------------------|-------------|--|----------------------|--|--|----------------------|------|
| (AE114 / 115, CE114) | 4.92 - 9.01 | | 334187 L 334186 R | | | 333287 L 333286 R | |
|----------------------|-------------|--|----------------------|--|--|----------------------|------|

Corolla (No. = JT152..., JTB52...), (No. = JT164..., JTB64...) (4.97-9.01)

| | | | | | | | |
|---|-------------|--|--|--|--|--|------|
| 1300-16V, 1600-16V (EE111, AE111) 1400-16V, 1600-16V (ZZE111, ZZE112) Exc. Rough Road Package | 4.97 - 9.01 | | 333237 L ¹⁾ 333236 R ¹⁾ 323064 L 323063 R | | | 334179 L ⁴⁾ 334178 R ⁴⁾ 324045 L 324044 R | |
| 1300-16V, 1400-16V, 1600-16V ⊕ Rough Road Package | 4.97 - 9.01 | | 334187 L ³⁾ 334186 R ³⁾ | | | 333117 L ⁵⁾ 333116 R ⁵⁾ | |
| 2000 Diesel (CE110) 1800 Diesel (WZE110) 1900 Diesel 2000 D4D | 4.97 - 7.01 | | 334177 L ²⁾ 334176 R ²⁾ | | | 334179 L ⁴⁾ 334178 R ⁴⁾ | |

1) ↔ 5)

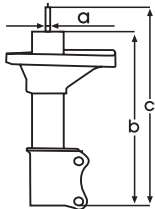

| | a | b | c |
|-------------------------|-------|--------|--------|
| 1) 333237 L 333236 R | 20 mm | 328 mm | 479 mm |
| 2) 334177 L 334176 R | 22 mm | 323 mm | 481 mm |
| 3) 334187 L 334186 R | 22 mm | 338 mm | 486 mm |

| | a | b | c |
|-------------------------|-------|--------|--------|
| 4) 334179 L 334178 R | 20 mm | 368 mm | 523 mm |
| 5) 333117 L 333116 R | 20 mm | 368 mm | 571 mm |

Corolla (10.01-)

| | | | | | | | |
|--|---------|--|----------------------|--|--|------------------|------|
| 1.4 VVTi (ZZE120) 1.4 D4D (NDE120) Exc. Rough Road Package | 10.01 - | | 333359 L 333358 R | | | 341816 351701 | |
| 1.6 VVTi (ZZE121) Exc. Rough Road Package | 10.01 - | | 333359 L 333358 R | | | 341816 351701 | |



| MODEL FAHRZEUG MODELE | YEAR JAHR ANNEE | FRONT/VORNE/AVANT | | | | REAR/HINTEN/ARRIERE | | | |
|-----------------------------|-----------------------|-----------------------------|-----------------------------|--------------------------------|--|-----------------------------|-----------------------------|--------------------------------|--|
| | | PREMIUM Twin-tube Oil | EXCEL-G Twin-tube Gas | GAS-A-JUST Mono-tube Gas | | PREMIUM Twin-tube Oil | EXCEL-G Twin-tube Gas | GAS-A-JUST Mono-tube Gas | |

Toyota (J)

Corolla (10.01-)

| | | | | | | | | | |
|---|---------|--|----------------------|--|--|--|------------------|--|--|
| 1.6 VVTi (ZZE121) Exc. Rough Road Package | 10.01 - | | 333359 L 333358 R | | | | 341322 | | |
| | | | | | | | | | |
| 1.6 VVTi (ZZE121) , Rough Road Package | 10.01 - | | | | | | | | |
| 2.0 D4D (CDE120) Exc. Rough Road Package | 10.01 - | | 333359 L 333358 R | | | | 341816 351701 | | |
| | | | | | | | | | |

1) → 5.04

Corolla (10.01-)

| | | | | | | | | | |
|--|---------|--|----------------------|--|--|--|------------------|--|--|
| 1.4 (ZZE120) 1.4 D4D (NDE120) 1.6 VVTi (ZZE121) Exc. Rough Road Package | 10.01 - | | 333359 L 333358 R | | | | 341816 351701 | | |
| | | | | | | | | | |
| 2.0 D4D (CDE120) Exc. Rough Road Package | 10.01 - | | 333359 L 333358 R | | | | 341816 351701 | | |
| | | | | | | | | | |
| 1.6 VVTi (ZZE121) , Rough Road Package | 10.01 - | | | | | | | | |

1) → 5.04

Corolla (9.02-) (E12U_)

| | | | | | | | | | |
|---|--------|--|----------------------|--|--|--|------------------|--|--|
| 1.4 (ZZE120) 1.4 D (NDE120) 1.4 VVTi (ZZE111) 1.6 (ZZE121) 1.6 VVTi (ZZE112) 1.8 (ZZE123) 2.0 TD (CDE120) 2.0 D4D (CDE120) | 9.02 - | | 334818 L 334817 R | | | | 341816 351701 | | |
| | | | | | | | | | |
| | | | | | | | | | |

Corolla (No. = SB164...) (4.97-11.01)

| | | | | | | | | | |
|-----------------------------------|-------------|--|--|--|--|--|--|--|--|
| 1300-16V, 1600-16V (EE111, AE111) | 9.98 - 1.99 | | 334177 L ¹⁾ 334176 R ¹⁾ | | | | 334179 L ²⁾ 334178 R ²⁾ | | |
| | | | | | | | | | |

1) ↔ 2)

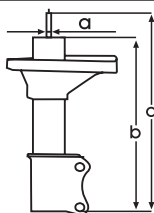

| | a | b | c |
|-------------------------|-------|--------|--------|
| 1) 334177 L 334176 R | 22 mm | 323 mm | 481 mm |

| | a | b | c |
|-------------------------|-------|--------|--------|
| 2) 334179 L 334178 R | 20 mm | 368 mm | 523 mm |



| MODEL FAHRZEUG MODELE | YEAR JAHR ANNEE | FRONT/VORNE/AVANT | | | REAR/HINTEN/ARRIERE | | |
|-----------------------------|-----------------------|-----------------------------|-----------------------------|--------------------------------|-----------------------------|-----------------------------|--------------------------------|
| | | PREMIUM Twin-tube Oil | EXCEL-G Twin-tube Gas | GAS-A-JUST Mono-tube Gas | PREMIUM Twin-tube Oil | EXCEL-G Twin-tube Gas | GAS-A-JUST Mono-tube Gas |

Toyota (J)

Corolla (SB164...) (4.97-11.01)

| | | | | | | |
|-------------------------------------|---------------|--|--|--|--|--|
| 1300-16V, 1600-16V (EE111, AE111) | 1.99 - 7.99 | | 333237 L ¹⁾ 333236 R ¹⁾ | | 334179 L ³⁾ 334178 R ³⁾ | |
| | | | SM5104 | | 910254 SM5074 L SM5075 R | |
| 1300-16V, 1600-16V (EE111, AE111) | 7.99 - 11.99 | | 334177 L ²⁾ 334176 R ²⁾ | | 334179 L ³⁾ 334178 R ³⁾ | |
| | | | SM5104 | | 910254 SM5074 L SM5075 R | |
| 1400-16V, 1600-16V (ZZE111, ZZE112) | 11.99 - 11.01 | | 334177 L ²⁾ 334176 R ²⁾ | | 334179 L ³⁾ 334178 R ³⁾ | |
| | | | SM5104 | | 910254 SM5074 L SM5075 R | |
| 1800 Diesel (WZE110) | 12.99 - 11.01 | | 334177 L ²⁾ 334176 R ²⁾ | | 334179 L ³⁾ 334178 R ³⁾ | |
| | | | SM5104 | | 910254 SM5074 L SM5075 R | |

1) ⇔ 3)

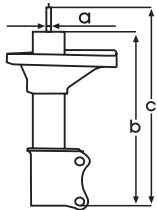

| | a | b | c |
|-------------------------|-------|--------|--------|
| 1) 333237 L 333236 R | 20 mm | 328 mm | 479 mm |
| 2) 334177 L 334176 R | 22 mm | 323 mm | 481 mm |

| | a | b | c |
|-------------------------|-------|--------|--------|
| 3) 334179 L 334178 R | 20 mm | 368 mm | 523 mm |

Corolla (1.02-)

| | | | | | | |
|---|--------|--|----------------------|--|----------------|--|
| 1.4 (ZZE120) 1.4 D, D4D 1.6 (ZZE121) 2.0 TD (CDE120) | 1.02 - | | 334818 L 334817 R | | 341816 | |
| | | | 324701 L 324700 R | | 351701 | |
| | | | 910049 SM5215 | | 910053 SM5382 | |

Corolla (E12U_) (11.01-)

| | | | | | | |
|---|---------|--|----------------------|--|----------------|--|
| 1.4 (ZZE120) 1.4 D (ZZE121) 1.4 VVTi (ZZE120) 1.6 (ZZE121) 1.6 VVTi (ZZE121) 1.8 (ZZE123) 1.8 VVTi (ZZE123) 2.0 TD (CDE120) 2.0 D4D (CDE120) Exc. Rough Road Package | 11.01 - | | 334818 L 334817 R | | 341816 | |
| | | | 324701 L 324700 R | | 351701 | |
| | | | 910049 SM5215 | | 910053 SM5382 | |

Corolla (E15)

| | | | | | | |
|--|---------|--|----------------------|--|----------------|--|
| 1.33, 1.6 (E15_) 1.3 VVTi, 1.4 VVTi, 1.6 VVTi 1.4 D4D, 2.0 D4D | 10.06 - | | 339701 L 339700 R | | 344811 | |
| | | | 910079 | | 912029 SM9921 | |



| MODEL FAHRZEUG MODELE | YEAR JAHR ANNEE | FRONT/VORNE/AVANT | | | | REAR/HINTEN/ARRIERE | | | |
|---|---|-----------------------------|-----------------------------|--------------------------------|--|-----------------------------|-----------------------------|--------------------------------|--|
| | | PREMIUM Twin-tube Oil | EXCEL-G Twin-tube Gas | GAS-A-JUST Mono-tube Gas | | PREMIUM Twin-tube Oil | EXCEL-G Twin-tube Gas | GAS-A-JUST Mono-tube Gas | |
| Toyota (J) | | | | | | | | | |
| Corolla (E18) | | | | | | | | | |
| 1.3, 1.6 (90 kW, 97 kW) 1.8 VVTi (103 kW), 1.4 D-4D Incl. H/D | (_E18_) 6.13 - | | 339701 L 339700 R | | | | 3448008 | | |
| | | | SM5639 | | | 912030 | SM9911 | | |
| Corolla Verso | | | | | | | | | |
| 1.4 D4D, 1.4 D 1.6 VVTi 1.8 VVTi | (ZZE121) (ZZE122) 9.01 - 12.03 | | 333359 L 333358 R | | | | 341816 351701 | | |
| | | 910048 | SM5215 | | | 910053 | SM5382 | | |
| 2.0 D4D | (CDE120) 9.01 - 12.03 | | 333359 L 333358 R | | | | 341816 351701 | | |
| | | 910283 ¹⁾ | SM5215 | | | 910053 | SM5382 | | |
| 1.4 VVTi, 1.4 D 1.4 D4D 1.6 VVTi, 2.0 1.8 VVTi 2.0 TD, D4D 2.2 D4D | (ZNR10) (ZNR11) (CUR10) (AUR10) 2.04 - | | 334833 L 334832 R | | | | 341821 | | |
| | | 910048 | SM1010 | | | 910210 | SM5382 | | |
| 1) → 5.04 | | | | | | | | | |
| Corona | | | | | | | | | |
| 1500, 1600, 1700, 1900 (RT 40/50/60/70/90 series, RT 82 S/84 S/95 S) | 64 - 3.73 | | | 553057 | | | | 553055 | |
| (RT 80/81/82/84) 1700 | 2.70 - 7.73 | | | 553057 | | | | 553055 | |
| 1600, 1800, 2000 (RT 100/110/120, TT 100/1105/120) | 8.73 - 78 | | | 553057 | | | | | |
| (RT 116) 1800 | 8.73 - 78 | | | 553057 | | | | | |
| (RT 106 V/108 V, TT 106 V) 1600, 1800 | 8.73 - 78 | | | 553057 | | 443179 | 343214▼ | | |
| 1600, 1800, 2000 ⊕ ⊗ (TT 130/131, RT 131/133) | 9.78 - 12.81 | 665021 | | | | 443102 | 343039 | | |
| 1800, 2000 ⊕ ⊗ (TT 131/132, RT 132/133) | 9.78 - 12.81 | 665024▼ | | | | 443102 | 343039 | | |
| (AT 140, ST 140) 1500, 1800 | 1.82 - 12.86 | 665021 | | | | 443102 | 343039 | | |



| MODEL FAHRZEUG MODELE | YEAR JAHR ANNEE | FRONT/VORNE/AVANT | | | | | REAR/HINTEN/ARRIERE | | | |
|--|----------------------------|-----------------------------|-----------------------------|--------------------------------|-----------------------------|--------|-----------------------------|--------------------------------|--|--|
| | | PREMIUM Twin-tube Oil | EXCEL-G Twin-tube Gas | GAS-A-JUST Mono-tube Gas | PREMIUM Twin-tube Oil | | EXCEL-G Twin-tube Gas | GAS-A-JUST Mono-tube Gas | | |
| Toyota (J) | | | | | | | | | | |
| Corona | | | | | | | | | | |
| (CT 140) 1800 Diesel | 1.82 - 12.86 | | | | | 443102 | 343039 | | | |
| (TT 142, RT 141) 1800, 2000 | 1.82 - 12.86 | 665024▼ | | | | | 343042 | | | |
| (TT 137 V, RT 137 V) 1600, 1800 | 9.78 - 12.81 | 665021 | | | | | | | | |
| (TT 147 V, CT 147 V) 1600, 1800 | 1.82 - 12.86 | 665021 | | | | | | | | |
| Corona Mk II & Cressida | | | | | | | | | | |
| (RT 60/70 series) 1600, 1700, 1900 | 9.68 - 12.71 | | | 553057 | | | | 553060 | | |
| (RX 10/20, MX 10/20) 1800, 2000, 2300 SL, GSL, GSS | 1.72 - 12.76 | | | 553057 | | | | | | |
| (RX 16 V/17 V) 1800 | 2.71 - 12.76 | | | 553057 | | 443179 | 343214▼ | | | |
| (RX 26/27/28, MX 27) 1800, 2000 | 1.71 - 12.76 | | | 553057 | | | | 553060 | | |
| (RX 63, GX 61, MX 61) 2000 GT, LG Touring | 9.80 - 7.84 | | 365076 | | | | | | | |
| 2000 GD, Turbo (MX 61, GX 61) 2400 Turbo Diesel (LX 65) | 8.82 - 7.84 8.82 - 7.84 | | 365076 | | | | | | | |
| (SX 60) 1800 | 8.82 - 7.84 | | 365076 | | | | | | | |
| (LX 60) 2200 D | 8.82 - 7.84 | | 365076 | | | | | | | |
| (GX 60 G, LX 60) 2000, 2200 | 11.80 - 8.82 | | | | | 443102 | 343039 | | | |
| Hilux | | | | | | | | | | |
| (2WD) RN 10/20 series | 68 - 8.78 | | | 553057 | | 444026 | | 553060 | | |
| (2WD) RN 30/35/40 | 9.78 - 8.80 | | | 553122 | | 444026 | | 553060 | | |
| (4WD) RN 36/39 | 9.78 - 10.83 | 443106 | 343195 | 553110▼ | | | | | | |
| (2WD) LN 30/40/41 | 12.79 - 3.84 | | | 553122 | | 444026 | | 553060 | | |
| (4WD) LN 36/46 | 10.81 - 10.83 | 443106 | 343195 | 553110▼ | | 443183 | 343245▼ | | | |



| MODEL FAHRZEUG MODELE | YEAR JAHR ANNEE | FRONT/VORNE/AVANT | | | | REAR/HINTEN/ARRIERE | | | |
|---|--|-----------------------------|-----------------------------|--------------------------------|--|-----------------------------|-----------------------------|--------------------------------|--|
| | | PREMIUM Twin-tube Oil | EXCEL-G Twin-tube Gas | GAS-A-JUST Mono-tube Gas | | PREMIUM Twin-tube Oil | EXCEL-G Twin-tube Gas | GAS-A-JUST Mono-tube Gas | |
| Toyota (J) | | | | | | | | | |
| Hilux | | | | | | | | | |
| (2WD) YN/LN 50 series | 11.83- 8.88 | 443214 | 343198 | 553117 | | 443217 | | 553118 | |
| (4WD) YN/LN 60, YN/LN 65 Exc. VAN | 11.83- 8.88 | 443106 | 343195 | 553110▼ | | 443241▼ | 343300 | 553160 | |
| (2WD) LN/YN 85 LN 85 | 8.88- 8.97 | 443214 | 343198 | 553117 | | 443217 | | 553118 | |
| (2WD) LN/YN 85 | 8.88- 8.97 | 443214 | 343198 | 553117 | | 443259 | 343252▼ | 553209 | |
| (2WD) LN/YN 90 | 8.88- 10.91 | 443214 | 343198 | 553117 | | 443258 | 343251 | 553189 | |
| (4WD) LN 105, YN 106 | 8.88- 8.97 | 443106 | 343195 | 553110▼ | | 443257 L 443254 R | 343253 L 343246 R | 553190 L 553191 R | |
| (4WD) RN106 LN/YN/RN110 LN108 | 8.89- 8.97 8.88- 8.97 8.91- 8.97 | 444103 | 344202 | 554069 | | 443257 L 443254 R | 343253 L 343246 R | 553190 L 553191 R | |
| LN145 LN150 | 8.97- 8.01 | 443214 | 343198 | 553117 | | 443297▼ | | 553233 | |
| LN145 | 8.97- 8.01 | 443214 | 343198 | 553117 | | 443298 | | 553234 | |
| LN165, LN170 RZN168, RZN173 | 8.97- 8.01 | | 344202 | 554069 | | | 343300 L 343299 R | 553160 L 553235 R | |
| KDN145, KDN150 | 8.01 - | 443214 | 343198 | 553117 | | 443297▼ | | 553233 | |
| KDN165 KDN170, KDN190 | 8.01 - | | 344202 | 554069 | | | 343300 L 343299 R | 553160 L 553235 R | |
| KDN165 | 8.01 - | | | | | | 343300 L 343299 R | 553160 L 553235 R | |
| (2WD) KUN 15, KUN 16 | 8.04 - | | 341398 L 341397 R | | | | 349023 | | |
| (4WD) KUN 25 | 8.04 - | | 341372 | | | | 349015 | | |
| Hilux VIII (N1) 2.4 D (2WD) 2.4 D (110 kW) (4WD) | 5.15 - | | 341396 | | | | 3440051◇ | | |
| Hilux VIII (N1) 2.4 D (125 kW) (4WD) 2.8 D (130 kW) (4WD) | 5.15 - | | 341396 | | | | | | |
| Hilux VIII (N1) 2.8 D (2WD) | 5.15 - | | 341396 | | | | 3440051◇ | | |



Toyota

| MODEL FAHRZEUG MODELE | YEAR JAHR ANNEE | FRONT/VORNE/AVANT | | | | | REAR/HINTEN/ARRIERE | | | |
|---|------------------------------|-----------------------------|-----------------------------|--------------------------------|--|--------|-----------------------------|-----------------------------|--------------------------------|--|
| | | PREMIUM Twin-tube Oil | EXCEL-G Twin-tube Gas | GAS-A-JUST Mono-tube Gas | | | PREMIUM Twin-tube Oil | EXCEL-G Twin-tube Gas | GAS-A-JUST Mono-tube Gas | |
| Toyota (J) | | | | | | | | | | |
| Highlander | | | | | | | | | | |
| 2.7 VVTi (ASU50) | 9.14 - 10.15 | | 335824 L 335823 R | | | | | | | |
| iQ | | | | | | | | | | |
| 1.0 VVTi 1.3 VVTi 1.4 D4D | 1.09 - | | | | | | 348037 | | | |
| ∞ 912023 | | | | | | | | | | |
| Land Cruiser | | | | | | | | | | |
| FJ, BJ 40 series | 3.69 - 1.75 | 444024 | | | | 444026 | | | | |
| FJ, BJ 40 series BJ 44V | 1.75 - 4.86 10.81 - 10.85 | 444024 | | | | 444012 | 344015▼ | | | |
| FJ, BJ 50 series | 3.69 - 7.80 | 444027▼ | | | | 444026 | | | | |
| BJ 60, HJ 60, FJ 60/62 WGV (Van Type) | 8.80 - 10.85 | | | | | 444012 | 344015▼ | | | |
| HJ 60/61, FJ 60/62 WGG (G Type) | 8.80 - 10.85 | 444078 | | 554044▼ | | 444012 | 344015▼ | | | |
| BJ 60, HJ 60/61, FJ 60/62 WGV (Van Type) | 11.86 - 8.87 | 444078 | | 554044▼ | | | | | | |
| HJ 60/61, FJ 62 WGG (G Type) Exc. Tire 10 R 15-6 | 10.85 - 8.87 | 444078 | | 554044▼ | | | | | | |
| HJ 60/61, FJ 62 WGG (G Type) ⊕ Tire 10 R 15-6 | 10.85 - 8.87 | 444078 | | 554044▼ | | | | | | |
| FJ 62, HJ 60/61 Exc. 7JJ x 15 wheel | 8.87 - 1.90 | | 345008 | | | | 345019 L 345018 R | | | |
| FJ 62 GX, GV ⊕ 7JJ x 15 wheel HJ 60/61 GX, GV ⊕ 7JJ x 15 wheel | 8.87 - 1.90 | | 345008 | | | | | | | |
| BJ 70/71/73 | 11.84 - 8.87 | 444114▼ | 344060 | 554055▼ | | 444092 | 344216▼ | | | |
| BJ 70/71/73 | 8.87 - 1.90 | 444106▼ | 344207 | 554079 | | 444092 | 344216▼ | | | |
| BJ 75 | 11.84 - 8.87 | 444114▼ | 344060 | 554055▼ | | 444107 | 344061▼ | | | |
| BJ 75 | 8.87 - 1.90 | 444106▼ | 344207 | 554079 | | 444107 | 344061▼ | | | |



| MODEL FAHRZEUG MODELE | YEAR JAHR ANNEE | FRONT/VORNE/AVANT | | | | REAR/HINTEN/ARRIERE | | | |
|---|----------------------------|-----------------------------|-----------------------------|--------------------------------|--|--|--|--------------------------------|--|
| | | PREMIUM Twin-tube Oil | EXCEL-G Twin-tube Gas | GAS-A-JUST Mono-tube Gas | | PREMIUM Twin-tube Oil | EXCEL-G Twin-tube Gas | GAS-A-JUST Mono-tube Gas | |
| Toyota (J) | | | | | | | | | |
| Land Cruiser | | | | | | | | | |
| RJ 70/73, LJ 70/73 | 11.84 - 8.87 | 444113 | 344213 | 554057▼ | | 444116 L ¹⁾ 444115 R ²⁾ | 344215 L ¹⁾ 344214 R ²⁾ | | |
| RJ 70/73 LJ 70/73 | 8.87 - 1.90 | 444113 | 344213 | 554057▼ | | | 345019 L ¹⁾ 345018 R ²⁾ | | |
| HZJ 70/73 PJZ 70/73 | 1.90 - 8.99 1.90 - 8.91 | 444110 | 344210▼ | | | 444112 | 344212▼ | | |
| PJZ 75 HZJ 75 | 1.90 - 8.92 8.92 - 8.99 | 444106▼ | 344207 | 554079 | | 444107 | 344061▼ | | |
| HZJ 71/74 | 8.99 - 8.01 | | | | | | 344212▼ | | |
| HZJ 78 | 8.99 - 8.01 | | 345044 | | | | 344460 | | |
| HZJ 79 | 8.99 - 8.01 | | 345044 | | | | 344461 | | |
| RJ 70/73, LJ 70/73/77 KZJ 70/73/77 | 1.90 - 4.96 5.93 - 4.96 | | 344211 | 554076▼ | | | 345011 | 555005▼ | |
| HDJ 80, HZJ 80, FJ 80 FZJ 80 | 1.90 - 98 8.92 - 98 | | 345020 | | | | 345010 | | |
| KZJ 90 3.0 Diesel KZJ 95 3.0 Diesel KDJ 90 3.0 Diesel KDJ 95 3.0 Diesel VZJ 90 3.4 VZJ 95 3.4 Exc. | 3.96 - 9.02 | | 341232 351031 | | | | 344288 354005 | | |
| HDJ 100 4.2 Diesel Turbo UZJ 100 4.7 Exc. | 1.98 - | | 345022 | | | | 345023 | | |
| KDJ 125 3.0 TD GRJ 125 4.0 Exc. | 9.02 - 1.03 - | | 341340 | | | | 344410 | | |
| KDJ 120 3.0 TD GRJ 120 4.0 Exc. | 9.02 - 1.03 - | | 341344 | | | | 344416 | | |
| | | 917006 ³⁾ | | | | | | | |
| 4.7 (UZJ200) 4.5 D (VDJ200) | 9.07 - 9.07 - | | 340062 | | | | 345087 | | |
| 4.6 (URJ202) | 1.12 - | | 340062 | | | | | | |
| 1) 2) 3) | | | | | | | | | |
| Land Cruiser (_J15_) | | | | | | | | | |
| 3.0 D-4D (KDJ150) 4.0 V6 VVTi (207 kW) (GRJ125, GRJ150) 4.0 V6 Dual VVTi (GRJ150) Exc. Types VX-L, TX-L/VX Exc. , Prado | 8.09 - 8.09 - 8.09 - | | 340085 | 5510017 | | | 3450004 | | |



Toyota

| MODEL FAHRZEUG MODELE | YEAR JAHR ANNEE | FRONT/VORNE/AVANT | | | | REAR/HINTEN/ARRIERE | | | |
|---|---|-----------------------------|-----------------------------|--------------------------------|--|-----------------------------|-----------------------------|--------------------------------|--|
| | | PREMIUM Twin-tube Oil | EXCEL-G Twin-tube Gas | GAS-A-JUST Mono-tube Gas | | PREMIUM Twin-tube Oil | EXCEL-G Twin-tube Gas | GAS-A-JUST Mono-tube Gas | |
| Toyota (J) | | | | | | | | | |
| Land Cruiser (_J15_) | | | | | | | | | |
| 3.0 D-4D (KDJ155) Exc. , Prado | 10.10 - | | 340085 | 5510017 | | | 3450000 | 5540001 | |
| 3.0 D-4D (KDJ150) 3.0 D-4D (KDJ155) 4.0 V6 VVTi (207 kW) (GRJ125, GRJ150) Exc. Prado | 8.09 - 10.10 - 9.12 8.09 - | | 340085 | 5510017 | | | 3450000 | 5540001 | |
| 3.0 D-4D (KDJ150) 4.0 V6 VVTi (207 kW) (GRJ125, GRJ150) 4.0 V6 Dual VVTi (GRJ150) Type TX-L/VX Exc. Prado | 8.09 - 2.12 8.09 - 2.12 8.09 - 2.12 | | 340125 | | | | | | |
| 4.0 V6 VVTi (202 kW) (GRJ150) Exc. , Prado | 8.09 - | | 340085 | 5510017 | | | 3450000 | 5540001 | |
| 4.0 V6 VVTi (202 kW) (GRJ150) , type VX Exc. Prado | 8.09 - 2.12 | | 340125 | | | | | | |
| Land Cruiser Prado (_J15_) | | | | | | | | | |
| 3.0 D-4D (KDJ150) 4.0 V6 VVTi (kW : 183, 207) (GRJ125, GRJ150) Exc. Types VX-L, TX-L/VX Exc. , , | 8.09 - 8.09 - | | 340085 | 5510017 | | | 3450004 | | |
| 3.0 D-4D (127 kW) (KDJ155) 4.0 V6 VVTi (183 kW) (GRJ150) | 8.09 - 1.10 - | | 340085 | 5510017 | | | 3450000 | 5540001 | |
| 4.0 V6 VVTi (207 kW) (GRJ125, GRJ150) | 8.09 - | | 340085 | 5510017 | | | 3450000 | 5540001 | |
| 3.0 D-4D (140 kW) (KDJ150) | 10.10 - | | 340085 | 5510017 | | | 3450000 | 5540001 | |
| 3.0 D-4D (140 kW) (KDJ150) 4.0 V6 VVTi (207 kW) (GRJ125, GRJ150) Type TX-L/VX | 10.10 - 2.12 8.09 - 2.12 | | 340125 | | | | | | |
| MR 2 | | | | | | | | | |
| 1.6 (AW 10, 11) | 6.84 - 8.86 | | 363045 | | | | 363046 | | |
| 1.6 (AW 11) | 9.86 - 90 | | 363045 | | | | 365086 | | |
| 2.0 16V Incl. ABS (SW20) | 90 - 00 | | 365099 | | | | 365100 | | |
| SM5161 | | | | | | | | | |
| MR 2 III | | | | | | | | | |
| 1.8 (W3) | 00 - | | 333321 L 333320 R | | | | 334311 L 334310 R | | |
| SM5799 | | | | | | | | | |



| MODEL FAHRZEUG MODELE | YEAR JAHR ANNEE | FRONT/VORNE/AVANT | | | | REAR/HINTEN/ARRIERE | | | |
|--------------------------------|-----------------------|-----------------------------|-----------------------------|--------------------------------|--|-----------------------------|-----------------------------|--------------------------------|--|
| | | PREMIUM Twin-tube Oil | EXCEL-G Twin-tube Gas | GAS-A-JUST Mono-tube Gas | | PREMIUM Twin-tube Oil | EXCEL-G Twin-tube Gas | GAS-A-JUST Mono-tube Gas | |
| Toyota (J) | | | | | | | | | |
| Paseo | | | | | | | | | |
| 1500 | (EL54) | 8.95 - 7.99 | | 333210 L 333209 R | | | 341191 | 551064▼ | |
| | | | | SM5089 | | | SM5163 | | |
| Picnic | | | | | | | | | |
| 2.0 i, 2.2 TD | (SXM 10, CXM 10) | 9.96 - 5.01 | | 334173 L 334172 R | | | 343282 | | |
| | | | | 910051 | | | | | |
| Previa / Emina / Lucida | | | | | | | | | |
| | (TCR10) (TCR20) | 5.90 - 00 | | 334094 L 334093 R | | | 344226 | | |
| | | | | SM5090 | | | | | |
| | (TCR11) (TCR21) | 5.90 - 00 | | 334094 L 334093 R | | | 344225 | | |
| | | | | SM5090 | | | | | |
| | (R30) | 4.00 - | | 334285 L 334284 R | | | 344308 | | |
| | | | | | | | 912029 | | |
| Prius (Hybrid) | | | | | | | | | |
| | (HW1) | 8.00 - 7.03 | | 333361 L 333360 R | | | 341321 | | |
| | | | | 910048 SM5474 | | | 910053 SM5382 | | |
| | (HW2) | 8.03 - | | 333389 L 333388 R | | | 341363 | | |
| | | | | 910048 | | | 910053 SM5382 | | |
| | (ZVW30) | 1.09 - | | 339243 L 339242 R | | | 344811 | | |
| | | | | SM5665 | | | SM9921 ¹⁾ | | |
| 1) Incl. ZVW35 | | | | | | | | | |
| Prius +, Grand Prius + | | | | | | | | | |
| 1.8 Hybrid (73 kW) | (ZVW40) | 3.12 - | | 335081 L 335080 R | | | 349218 | | |
| | | | | SM5665 | | | | | |
| Prius | | | | | | | | | |
| 1.8 Hybrid (72 kW) Incl. | (_W5_) | 9.15 - | | 3350027 L 3350026 R | | | 3440083 | | |
| Prius PHV | | | | | | | | | |
| Incl. | (_W52_) | 1.16 - | | | | | 3440083 | | |



Toyota

| MODEL FAHRZEUG MODELE | YEAR JAHR ANNEE | FRONT/VORNE/AVANT | | | REAR/HINTEN/ARRIERE | | |
|-----------------------------|-----------------------|-----------------------------|-----------------------------|--------------------------------|-----------------------------|-----------------------------|--------------------------------|
| | | PREMIUM Twin-tube Oil | EXCEL-G Twin-tube Gas | GAS-A-JUST Mono-tube Gas | PREMIUM Twin-tube Oil | EXCEL-G Twin-tube Gas | GAS-A-JUST Mono-tube Gas |

Toyota (J)

| RAV 4 (2WD) (4WD) | | | | | | | | |
|---------------------------------|-------------------------------|----------------------------|--|--|------------------|--|--|----------|
| ALL | (SXA10) (SXA11) | 4.94 - 1.98 1.98 - 4.00 | | 365093 ¹⁾ 334483 L ²⁾ 334482 R ²⁾ 375035 ¹⁾ ▼ 324039 L ²⁾ ▼ 324038 R ²⁾ ▼ | | | 343272 ⁴⁾ 243033 ⁴⁾ | |
| | | | | 910110 SM5162 | | | | |
| | (SXA10) | 8.96 - 4.00 | | 334483 L ²⁾ 334482 R ²⁾ 324039 L ²⁾ ▼ 324038 R ²⁾ ▼ | | | 343313 ⁵⁾ | |
| | | | | 910110 SM5162 | | | | |
| 235-60- | (SXA11) | 8.96 - 4.00 | | 334252 L ³⁾ 334251 R ³⁾ | | | 343314 ⁶⁾ | |
| | | | | SM5162 | | | | |
| 1.8 2.0 2.0TD 2.0D | (ZCA25) (ACA20) (CLA20) | 5.00 - | | 3340114 L 3340113 R 324057 L 324056 R | | | 343272 | |
| | | | | 910050 SM5162 | | | | |
| 1.8 2.0 2.0TD 2.0D | (ZCA26) (ACA21) (CLA21) | 5.00 - | | 335041 L 335040 R 325002 L 325001 R | | | 343272 | |
| | | | | 910050 SM5162 | | | | |

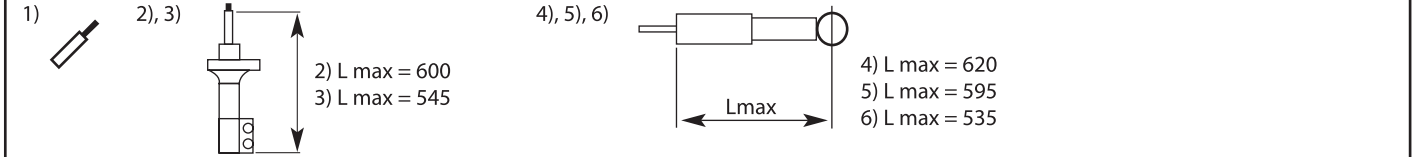

RAV 4 III (06-)

| | | | | | | | | |
|--|--------------------|--------|--|--|--|--|--------|----------|
| 2.0 VVT-i (4WD) 2.2 D-4D (4WD) 2.2 D-4D 180 (4WD) 2.4 VVT-i (2WD) (4WD) | (ACA30) (ACA30) | 1.06 - | | 339032 L 339031 R | | | 349024 | |
| | | | | 910074 SM5639 ¹⁾ SM5658 ²⁾ | | | | |

1) SM5639 : OE = 48609-42030 (incl.) = 48609-42060 (incl.) 2) SM5658 : OE = 48609-42020 (exc.) + 48619-42010 ()

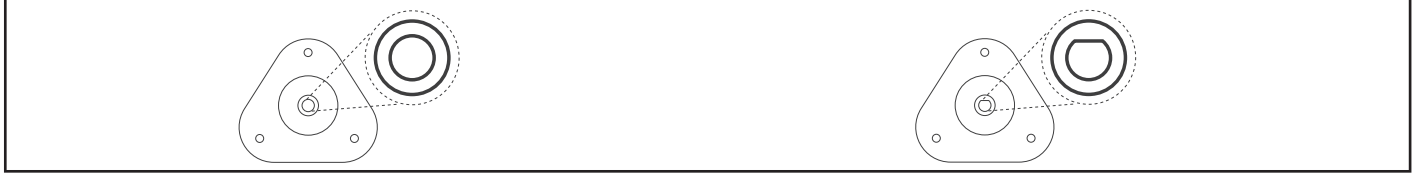



| MODEL FAHRZEUG MODELE | YEAR JAHR ANNEE | FRONT/VORNE/AVANT | | | | REAR/HINTEN/ARRIERE | | | |
|--|---|-----------------------------|-----------------------------|--------------------------------|--|-----------------------------|-----------------------------|--------------------------------|--|
| | | PREMIUM Twin-tube Oil | EXCEL-G Twin-tube Gas | GAS-A-JUST Mono-tube Gas | | PREMIUM Twin-tube Oil | EXCEL-G Twin-tube Gas | GAS-A-JUST Mono-tube Gas | |
| Toyota (J) | | | | | | | | | |
| RAV 4 IV (13-) | | | | | | | | | |
| 2.0 (105 kW) (_A4_) 2.0 (kW : 107, 111, 112) 2.0 D 2.2 D Incl. H/D | 12.12- | | 3350001 L 3350000 R | | | | 349024 | | |
| 2.0 (107 kW) (_A4_) 2.5 (132 kW) Exc. | 12.12- 12.18 | | 339335 L 339334 R | | | | 349024 | | |
| 2.0 (107 kW) (_A4_) 2.5 (132 kW) | 12.12- 12.18 | | 3350001 L 3350000 R | | | | 349024 | | |
| 2.5 Hybrid (_A4_) 2.5 Hybrid (114 kW) Incl. H/D | 10.15- 12.18 | | 3350039 L 3350038 R | | | | 349024 | | |
| RAV 4 V (18-) | | | | | | | | | |
| 2.0 (_A5_,_H5_) 2.0 VVTi 2.5 Hybrid (131 kW) 2.5 VVTi (149 kW) Incl. | 12.18- | | | | | | 3440083 | | |
| 4-Runner / Hilux Surf | | | | | | | | | |
| 3.0 i (VZN 130) 2.4 D (LN 130) 3.0 TD (KZN 130) Exc. | 8.89- 11.95 1.90- 11.95 8.93- 11.95 | | 344202 | 554069 | | | 344254 | 554071 ▼ | |
| Starlet | | | | | | | | | |
| (KP60, KP62, KP61) 1000, 1200, 1300 | 2.78- 10.84 | | 363038 | | | | 342007 | 552006 | |
| (KP60V, KP62V, KP61V) 1000, 1200, 1300 | 10.78- 10.84 | | 363038 | | | | | | |
| (EP70, EP71, NP/NR70) 1000, 1300, 1500 Diesel | 10.84- 12.89 | | 363047 | | | | 341048 | | |
| | | | 913273 ▼ | | | | SM5088 | | |
| (EP80, EP81/82, NP80) 1000, 1300, 1500 Diesel | 7.90- 4.94 | | 333068 L 333067 R | | | | 341082 | 551050 ▼ | |
| | | | 910083 | | | | SM5088 | | |
| (EP80, EP81/82, NP80) 1000, 1300, 1500 Diesel | 5.94- 1.96 | | 333068 L 333067 R | | | | 341191 | 551064 ▼ | |
| | | | 910083 | | | | SM5163 | | |
| 1300 | (EP91) 1.96- 7.99 | | 333210 L 333209 R | | | | 341191 | 551064 ▼ | |
| | | | 910083 SM5089 | | | | | | |



| MODEL FAHRZEUG MODELE | YEAR JAHR ANNEE | FRONT/VORNE/AVANT | | | | REAR/HINTEN/ARRIERE | | | |
|---|-------------------------------|--|-----------------------------|--------------------------------|--------|-----------------------------|-----------------------------|--------------------------------|--|
| | | PREMIUM Twin-tube Oil | EXCEL-G Twin-tube Gas | GAS-A-JUST Mono-tube Gas | | PREMIUM Twin-tube Oil | EXCEL-G Twin-tube Gas | GAS-A-JUST Mono-tube Gas | |
| Toyota (J) | | | | | | | | | |
| Tercel & Corsa | | | | | | | | | |
| 1300, 1500 | (AL 20, 21) | 5.82 - 8.84 | 663039 | | | | | | |
| | | | | SM5067▼ | | | | SM5069 | |
| 1500 | (AL 25) | 8.82 - 1.88 | | 363037 | | | 343036 | | |
| | | | | SM5067▼ | | | | | |
| Town Ace/ Model F / Space Cruiser | | | | | | | | | |
| Town Ace | (RR 10/20) | 8.78 - 11.79 | | | | 443194 | 343153 | 553106▼ | |
| Town Ace | (RR 10/21) | 11.79 - 10.82 | | | | 443194 | 343153 | 553106▼ | |
| 1800 2000 2000 Diesel | (YR 20) (YR 21) (CR 21) | 11.82 - 8.84 8.84 - 8.85 5.83 - 8.84 | | 343190 | | | | | |
| 2000 2200 | (YR 21) (YR 21) | 8.85 - 90 8.86 - 90 | | 343190 | | | 343192 | | |
| 2200 | (YR 31) | 8.86 - 90 | | 343277 | | | 343278 | | |
| Urban Cruiser | | | | | | | | | |
| 1.4 Diesel Turbo | 1.09 - | | | 339268 L 339267 R | | | 348030 | | |
| | | | | 910209 | SM5641 | | | | |
| 1.3 | 1.09 - | | | 339135 L 339134 R | | | 348001 | | |
| | | | | 910209 | | | 912023 | | |
| Verso | | | | | | | | | |
| 1.6, 1.8 | 4.09 - | | | 335822 L 335821 R | | | 344705 | | |
| | | | | SM1011 | | | SM9938 | | |
| 1.6 D4-D 2.0 D-4D (93 kW) 2.2 D-4D, 2.2 D-CAT | 4.09 - | | | 335824 L 335823 R | | | 344705 | | |
| | | | | SM1011 | | | SM9938 | | |
| 1.6 D-4D exc. 2.0 D-4D (91 kW) | 11.12 - | | | 3358006 L 3358005 R | | | 344705 | | |
| | | | | SM1011 | | | SM9938 | | |
| Verso S | | | | | | | | | |
| 1.3 16V 1.4 D4-D Incl. | 11.10 - | | | 339135 L 339134 R | | | 348001 | | |
| | | | | 910209 | | | 912023 | | |



| MODEL FAHRZEUG MODELE | YEAR JAHR ANNEE | FRONT/VORNE/AVANT | | | | REAR/HINTEN/ARRIERE | | | |
|-----------------------------|-----------------------|-----------------------------|-----------------------------|--------------------------------|--|-----------------------------|-----------------------------|--------------------------------|--|
| | | PREMIUM Twin-tube Oil | EXCEL-G Twin-tube Gas | GAS-A-JUST Mono-tube Gas | | PREMIUM Twin-tube Oil | EXCEL-G Twin-tube Gas | GAS-A-JUST Mono-tube Gas | |

Toyota (J)

Yaris I

| | | | | | |
|---|--|---|--|--------|---|
| 1.0 (2WD) (P10) 1.3 (2WD) 1.4 TD, D4D (2WD) | 3.99 - 1.06 3.99 - 1.06 10.01 - 1.06 | 333368 | | 343431 | |
| | | 323058 | | 353015 | |
| | | 910047 ¹⁾²⁾ SM5472 ¹⁾³⁾ SM1024 ¹⁾³⁾ SM1025 ¹⁾³⁾ | | | 910052 ¹⁾⁴⁾ SM9905 ¹⁾⁵⁾ |
| 1.5 (2WD) (P10) | 1.01 - 1.06 | 333368 | | 343805 | |
| | | 323058 | | 353024 | |
| | | 910047 ¹⁾²⁾ SM5472 ¹⁾³⁾ SM1024 ¹⁾³⁾ SM1025 ¹⁾³⁾ | | | 910052 ¹⁾⁴⁾ SM9905 ¹⁾⁵⁾ |

1)

| | | | | | | | | | | | | | | | | |
|---|---|---|---|---|---|---|---|---|----|----|----|----|----|----|----|----|
| 1 | 2 | 3 | 4 | 5 | 6 | 7 | 8 | 9 | 10 | 11 | 12 | 13 | 14 | 15 | 16 | 17 |
| - | - | - | - | - | - | - | - | - | - | - | - | - | - | - | - | - |

↓
V =
J =
3 = Yaris

2)

| | | | |
|--|--|------|------------------|
| | | Exc. | 1.0 ⊕ Start & Go |
| | | | 1.5 |

 4) ⊕
5) ⊕

3)

| SM5472 | SM1024 | SM1025 | SM1024 |
|--------|--------|--------|--------|
| | | | |

Yaris II

| | | | | | |
|---|--------------|--|--|---|--|
| 1.0 VVT-i, 1.0 LPG 1.3 VVT-i, 1.33 VVT-i 1.4 D-4D | (P9_) 11.05- | 333746 L 333745 R | | 343809 | |
| | | 910144 ¹⁾²⁾ SM5641 ¹⁾³⁾ 910209 ¹⁾²⁾ SM1012 ¹⁾⁴⁾ | | 912023 ¹⁾⁵⁾ SM9905 ¹⁾⁵⁾ | |

1)

| | | | | | | | | | | | | | | | | |
|---|---|---|---|---|---|---|---|---|----|----|----|----|----|----|----|----|
| 1 | 2 | 3 | 4 | 5 | 6 | 7 | 8 | 9 | 10 | 11 | 12 | 13 | 14 | 15 | 16 | 17 |
| - | - | - | - | - | - | - | - | - | - | - | - | - | - | - | - | - |

↓
V =
J =
3 = Yaris

2)

| | | | |
|--------|--|-----|---|
| | | | |
| 910144 | | 1.0 | ∅ |
| 910209 | | 1.8 | |

3) ⊕
4) ⊕
5) ⊕



| MODEL FAHRZEUG MODELE | YEAR JAHR ANNEE | FRONT/VORNE/AVANT | | | REAR/HINTEN/ARRIERE | | |
|-----------------------------|-----------------------|-----------------------------|-----------------------------|--------------------------------|-----------------------------|-----------------------------|--------------------------------|
| | | PREMIUM Twin-tube Oil | EXCEL-G Twin-tube Gas | GAS-A-JUST Mono-tube Gas | PREMIUM Twin-tube Oil | EXCEL-G Twin-tube Gas | GAS-A-JUST Mono-tube Gas |

Toyota (J)

Yaris III

| | | | | | | | | | |
|---|---------|---------|--|--|--|---|--|--|--|
| 1.0, 1.3, 1.5, 1.4 D-4D Incl. Hybrid version Exc. Sport sus., | (_P13_) | 12.10 - | | 333746 L 333745 R | | 343823 | | | |
| | | | 910209 ⁽¹⁾²⁾ SM5641 ⁽¹⁾³⁾ SM1012 ⁽¹⁾⁴⁾ | | | 912023 ⁽¹⁾⁴⁾ SM9905 ⁽¹⁾⁵⁾ | | | |
| 1.0, 1.3, 1.5, 1.4 D-4D Incl. Hybrid version | (_P13_) | 12.10 - | | 333746 L 333745 R | | 343809 | | | |
| | | | | SM5641 ⁽¹⁾³⁾ SM1012 ⁽¹⁾⁴⁾ | | 912023 ⁽¹⁾⁴⁾ SM9905 ⁽¹⁾⁵⁾ | | | |
| 1.0, 1.3, 1.5, 1.4 D-4D Sport sus. Incl. Hybrid version | (_P13_) | 12.10 - | | 339757 L 339756 R | | 343823 | | | |
| | | | | SM5641 ⁽¹⁾³⁾ SM1012 ⁽¹⁾⁴⁾ | | 912023 ⁽¹⁾⁴⁾ SM9905 ⁽¹⁾⁵⁾ | | | |

1)

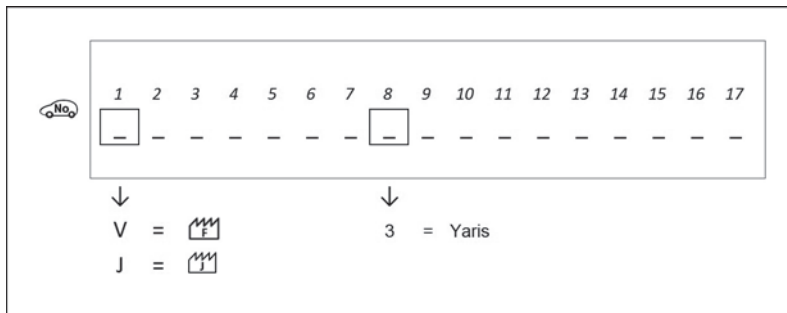

2)

| | | | | |
|--|--|--------|------|----------------------------------|
| | | → 1.13 | Exc. | Tyre 175/65R14 Tyre 185/60R15 |
|--|--|--------|------|----------------------------------|

3)

4)

5)

Yaris Verso

| | | | | | | | | | |
|---------------------------|--------------|--------|----------------|--------|--|--------|--|--|--|
| 1.3 1.5 1.4 TD, D4D | (_P21, _P22) | 8.99 - | | 333278 | | 343806 | | | |
| | | | 910047 SM1024 | | | 910052 | | | |

Toyota Commercial (J)

Coaster

| | | | | | | | | | |
|---------------------------------|-------------|--------|--|--|--|--------|--|--|--|
| Coaster (RU 19, BU 19) | 2.72 - 7.77 | 444024 | | | | 444025 | | | |
| Coaster (RB 11/12/13, BB 10/11) | 8.77 - 4.82 | 444040 | | | | 444025 | | | |

Dyna

| | | | | | | | | | |
|------------------------|-----------------------|----------------------------|--------|---------|--|--------|--------|--|--|
| Dyna | (RU/BU/JU 10) | 5.70 - 7.77 | 444024 | | | 444025 | | | |
| Dyna | (RU/JU 15) | 5.70 - 1.72 | | | | | | | |
| Dyna Exc. Low floor | (RU 15, BU 15/20/30) | 2.72 - 7.77 | 444024 | | | 444023 | 344102 | | |
| Dyna Exc. Low floor | (BU 20/30) | 7.7 - 11.84 | 444028 | 344062▼ | | 444023 | 344102 | | |
| Dyna Low floor | (BU 20/30) | 7.7 - 11.84 | 444028 | 344062▼ | | 444025 | | | |
| Dyna Dyna | (BU 35/36) (HU 50) | 8.80 - 8.84 4.82 - 8.84 | 444028 | 344062▼ | | 444023 | 344102 | | |



| MODEL FAHRZEUG MODELE | YEAR JAHR ANNEE | FRONT/VORNE/AVANT | | | | REAR/HINTEN/ARRIERE | | | |
|--|---|-----------------------------|-----------------------------|--------------------------------|--|-----------------------------|-----------------------------|--------------------------------|--|
| | | PREMIUM Twin-tube Oil | EXCEL-G Twin-tube Gas | GAS-A-JUST Mono-tube Gas | | PREMIUM Twin-tube Oil | EXCEL-G Twin-tube Gas | GAS-A-JUST Mono-tube Gas | |
| Toyota Commercial (J) | | | | | | | | | |
| Dyna | | | | | | | | | |
| Dyna (YU 60/70, BU 60/62) | 9.84 - | 444083 | | 553204▼ | | 444084 | 344065▼ | | |
| Dyna 250 (BU 84) | 86 - | 443260 | 343254 | | | 443262 | 343260▼ | | |
| Dyna 100 | | | | | | | | | |
| 1800 (YH 81) 2400 Diesel (LH 80) | 8.85 - 5.95 | 444085 | 344058 | | | | 344099 | | |
| 2400 Diesel (LY 100) | 5.95 - | 444085 | 344058 | | | | 344099 | | |
| Dyna 150 | | | | | | | | | |
| 1800 (YY 51/60) 2000 (YY 52/61) 2400 Diesel (LY 60) | 8.85 - 8.87 | 443260 | 343254 | | | 443262 | 343260▼ | | |
| 2000 (YY 61R) 2400 Diesel (LY 60R) | 8.85 - 8.87 | 443260 | 343254 | | | 443194 | 343153 | | |
| 2000 Diesel (LY 61L) 2400 Diesel (LY 60L) | 8.85 - 8.87 | 443260 | 343254 | | | 443285 | | 553193 | |
| 2800 Diesel (LY 61) | 8.88 - 5.95 | 443260 | 343254 | | | 443262 | 343260▼ | | |
| 2000 (YY 61) 2400 Diesel (LY 60) 2800 Diesel (LY 61) | 8.87 - 8.88 8.87 - 8.88 8.88 - 5.95 | 443280 | | 553203▼ | | 443285 | | 553193 | |
| 2000 (YY 211) 2800 Diesel (LY 211) 3000 Diesel (LY 212) | 5.95 - | 443260 | 343254 | | | 443262 | 343260▼ | | |
| 2000 (YY 211R) 2800 Diesel (LY 211R) 3000 Diesel (LY 212) | 5.95 - | 443260 | 343254 | | | 443194 | 343153 | | |
| 2800 Diesel (LY 211L) | 5.95 - | 443280 | | 553203▼ | | 443285 | | 553193 | |
| Hi-Ace | | | | | | | | | |
| (PH, RA, RH, LH series) | 9.67 - 12.82 | 444022 | | 554046 | | 444023 | 344102 | 553084 | |
| 1600 (RH11) 2200 Diesel (LH11) | 11.82 - 7.85 | 444022 | | 554046 | | 444023 | 344102 | 553084 | |
| Hi-Ace II (Commuter), 1.8 (YH50, YH60) 2.2 D (LH50, LH60) Exc. | 12.82 - 1.84 | 444085 | 344058 | | | 444084 | 344065▼ | | |



Toyota

| MODEL FAHRZEUG MODELE | YEAR JAHR ANNEE | FRONT/VORNE/AVANT | | | | REAR/HINTEN/ARRIERE | | | |
|-----------------------------|-----------------------|-----------------------------|-----------------------------|--------------------------------|--|-----------------------------|-----------------------------|--------------------------------|--|
| | | PREMIUM Twin-tube Oil | EXCEL-G Twin-tube Gas | GAS-A-JUST Mono-tube Gas | | PREMIUM Twin-tube Oil | EXCEL-G Twin-tube Gas | GAS-A-JUST Mono-tube Gas | |

Toyota Commercial (J)

Hi-Ace

| | | | | | | | | | |
|--|---|---------|--------|--|--|--------|---------|--------|--|
| Hi-Ace II (Commuter), 2.2 D (LH50, LH60) Exc. | 1.84 - 6.85 | 444085 | 344058 | | | | | | |
| Hi-Ace II (Commuter), 1.8 (YH50, YH60) 2.0 (YH51, YH61) 2.4 D (LH51, LH61) Exc. | 1.84 - 8.87 | 444085 | 344058 | | | | 344059 | 554053 | |
| Hi-Ace II (Commuter), 1.8 (YH50, YH60) 2.0 (YH51, YH61) 2.4 D (LH51, LH61) Exc. | 8.87 - 1.96 | | | | | | 344059 | 554053 | |
| 2000 (YH 56V) 2400 (YH 66V) 2400 Diesel (LH 56V, LH 66V) | 8.86 - 8.89 | 444093▼ | 344201 | | | | 344100 | | |
| 2000 (RZH 102/112) 2400 (RZH 103/113) 2400 Diesel (LH 102/112) | 8.89 - 8.95 | 444104 | 344203 | | | 444123 | 344100 | | |
| (Commuter) 2400 (RZH 115) | 8.89 - 5.92 | 444104 | 344203 | | | 444123 | 344100 | | |
| 2400 (RZH 109/119) 2400 Diesel (LH 108/118) | 8.89 - 5.92 | 444093▼ | 344201 | | | 444105 | 344204▼ | | |
| 2400 (RCH 12/22) 2700 (RCH 13/23) 2400 Diesel/Diesel Turbo (LXH 12/22) | 8.95 - 4.98 4.98 - 7.99 8.96 - 7.99 | | 344203 | | | | 344484 | | |
| 2400 (RCH 18/28) 2700 (RCH 19/29) 2400 Diesel/Diesel Turbo (LXH 18/28) | 8.95 - 4.98 4.98 - 7.99 8.96 - 7.99 | | 344201 | | | | 344485 | | |
| KLH 12/22 LXH 12/22 RCH 12/13/22/23 | 7.99 - | | 344203 | | | | 344485 | | |
| KLH 18/28 LXH 19/29 RCH 19/22 | 7.99 - | | 344201 | | | | 344485 | | |

Lite-Ace

| | | | | | | | | | |
|--------------------|--------------|--------|--|--|--|--------|--------|--------|--|
| (KM 20, CM 20) | 10.79 - 9.85 | 443181 | | | | 443149 | 343213 | 553116 | |
| (KM 20, CM 20) | 10.79 - 9.85 | 443181 | | | | 443150 | | | |



| MODEL FAHRZEUG MODELE | YEAR JAHR ANNEE | FRONT/VORNE/AVANT | | | | REAR/HINTEN/ARRIERE | | | |
|--|---|-----------------------------|--|--------------------------------|--|-----------------------------|-----------------------------|--------------------------------|--------|
| | | PREMIUM Twin-tube Oil | EXCEL-G Twin-tube Gas | GAS-A-JUST Mono-tube Gas | | PREMIUM Twin-tube Oil | EXCEL-G Twin-tube Gas | GAS-A-JUST Mono-tube Gas | |
| Toyota Commercial (J) | | | | | | | | | |
| Lite-Ace | | | | | | | | | |
| 1500 (KM 30) 2000 Diesel (CM 30) | 10.85 - 1.92 8.88 - 1.92 | | 343190 | | | | 343267 | | |
| 1500 (KM 31) | 10.85 - 8.86 | | | | | | | | |
| 1500 (KM 36) 1800 Diesel (CM 35) 2000 Diesel (CM 36) | 10.85 - 1.92 10.85 - 8.88 8.88 - 1.92 | | 343190 | | | | 343196 | | |
| 1500 (KR 21) 2200 (YR 22) 2000 Diesel (CR 21) | 1.92 - 5.94 1.92 - 1.95 1.92 - 1.95 | | 344255 | 554087 | | | 343192 | | |
| 1500 (KR 27) 2200 (YR 29) 2000 Diesel (CR 27) | 1.92 - 5.94 1.92 - 1.95 1.92 - 1.95 | | 344255 | 554087 | | | 344102 | 553084 | |
| ALL (KM 67) | 92 - | | 344255 | 554087 | | | 344102 | 553084 | |
| Proace | | | | | | | | | |
| ALL (MDZ_) | 2.16 - | | 3348085 ¹⁾ 3348084 ²⁾ | | | | 3458001 | | |
| Proace Verso | | | | | | | | | |
| ALL (MDY_) | 7.18 - | | 3348085 ¹⁾ 3348084 ²⁾ | | | | 3458001 | | |
| <div style="display: flex; justify-content: space-around;"> <div style="text-align: center;"> <p>1)</p> <p>282 mm</p> </div> <div style="text-align: center;"> <p>2)</p> <p>299 mm</p> </div> </div> | | | | | | | | | |
| Stout | | | | | | | | | |
| Stout (RK 45/45 V/45 P/45 B, RK 100) | 60 - 66 | | | | | | 444026 | | 553060 |
| Stout, Stout Van (RK 40/40 V/43) | 63 - 68 | | | 553057 | | | 444026 | | 553060 |
| Stout (RK 110/111) | 3.79 - | | | | | | 444023 | 344102 | |



Vauxhall

| MODEL FAHRZEUG MODELE | YEAR JAHR ANNEE | FRONT/VORNE/AVANT | | | | REAR/HINTEN/ARRIERE | | | |
|-----------------------------|-----------------------|-----------------------------|-----------------------------|--------------------------------|--|-----------------------------|-----------------------------|--------------------------------|--|
| | | PREMIUM Twin-tube Oil | EXCEL-G Twin-tube Gas | GAS-A-JUST Mono-tube Gas | | PREMIUM Twin-tube Oil | EXCEL-G Twin-tube Gas | GAS-A-JUST Mono-tube Gas | |

Vauxhall (GB)

Adam, Adam Rocks

| | | | | | | | | | |
|--|-------|--------------|-------------------------------|----------------------|--|---|---------|--|--|
| 1.0, 1.2, 1.4 Incl. Sport sus., Exc. 1.4 S, , Adam Rocks | (M13) | 10.12 - 4.19 | | 339715 L 339714 R | | | 3430061 | | |
| | | | 910203 ¹⁾ SM1820 | | | 910276 SM9806 L SM9805 R | | | |
| 1.0, 1.2, 1.4 , Adam Rocks Exc. 1.4 S, Sport sus., | (M13) | 10.12 - 4.19 | | | | | 3430061 | | |
| | | | 910134 ²⁾ SM1820 | | | 910277 SM9806 L SM9805 R | | | |
| 1.4 S | (M13) | 11.14 - 1.19 | | | | | | | |
| | | | 910203 ¹⁾³⁾ SM1820 | | | 910276 ³⁾ SM9806 L SM9805 R | | | |

1) Bumper height : 40 mm 2) Bumper height : 65 mm 3) Exc. , Adam Rocks

Agila

| | | | | | | | | | |
|---|-----|-------------|---------------------------|----------------------|--|--------|--------|--|--|
| Agila Mk I <u>(2WD)</u> 1.0, 1.2, 1.3 CDTI Incl. ABS | (A) | 4.00 - 8.07 | | 333307 L 333306 R | | | 343331 | | |
| | | | 910108 SM1035 | | | | | | |
| Agila Mk II 1.0, 1.2, 1.3 CDTI | (B) | 9.07 - | | 333409 L 333408 R | | | 343420 | | |
| | | | 912027▼ SM1034 912052 | | | SM9930 | | | |

Ampera

| | | | | | | | | | |
|--|---------|--------|-----------------------------|--|--|--|--|--|--|
| | (D1JOI) | 3.12 - | | | | | | | |
| | | | 910222 ¹⁾ SM1008 | | | | | | |

1) → 7.12
 → CU999999

Antara A

| | | | | | | | | | |
|---------------------------------------|-------|--------|--------|--------------------------|--|--|--------|--|--|
| <u>(2WD)</u> <u>(4WD)</u> Exc. | (L07) | 8.06 - | | 3350067 L◇ 3350066 R◇ | | | 345084 | | |
| | | | 910285 | | | | | | |

Astra Exc. VXR /

| | | | | | | | | | |
|------|--|-------------|-------------------|------------------|--|--------|--------|-------------------|--|
| | | 2.80 - 8.84 | 665036 | 365501 375009 | | 443134 | 343047 | 553075▼ 243014 | |
| | | | 915322▼ 910083 | | | | | | |
| | | 2.80 - 8.84 | 665036 | 365501 | | 443135 | 343099 | 553137▼ | |
| | | | 915322▼ 910083 | | | | | | |



| MODEL FAHRZEUG MODELE | YEAR JAHR ANNEE | FRONT/VORNE/AVANT | | | | REAR/HINTEN/ARRIERE | | | |
|-----------------------------|-----------------------|-----------------------------|-----------------------------|--------------------------------|--|-----------------------------|-----------------------------|--------------------------------|--|
| | | PREMIUM Twin-tube Oil | EXCEL-G Twin-tube Gas | GAS-A-JUST Mono-tube Gas | | PREMIUM Twin-tube Oil | EXCEL-G Twin-tube Gas | GAS-A-JUST Mono-tube Gas | |

Vauxhall (GB)

Astra Exc. VXR /

| | | | | | | | | | |
|---------------------|-----------|--------|------------------|--|--|--------|--------|-------------------|--|
| ALL Exc. GTE | 9.84 - 91 | 665036 | 365501 375009 | | | 443134 | 343047 | 553075▼ 243014 | |
| ALL | 9.84 - 91 | 665036 | 365501 | | | 443135 | 343099 | 553137▼ | |
| 1.8 GTE | 9.84 - 91 | | 365501 375009 | | | | 343047 | 553075▼ 243014 | |

1)

| Model | KYB |
|---------------------------|--------|
| 1.2 / 1.3 / 1.4 / 1.6 | SM1300 |
| 1.6 / 1.8 / 2.0 / Diesel | SM1307 |

Astra Exc. VXR /

| | | | | | | | | | |
|--|-------------|--------|----------------------|--|--|--------|--------|-------------------|--|
| Astra F ALL Exc. 1.8 i/2.0i SRi, GSi, Gt | 8.91 - 9.98 | 665501 | 365504 375034 | | | 443134 | 343047 | 553075▼ 243014 | |
| Astra F 1.8 i/2.0 i SRi, GSi ALL | 8.91 - 9.98 | | 365504 375034 | | | | 343047 | 553075▼ 243014 | |
| Astra F ALL | 3.91 - 2.98 | 665501 | 365504 | | | 443135 | 343099 | 553137▼ | |
| Astra G (F69, F48, F08, T98) ALL Exc. Sport sus. | 98 - 3.04 | | 334847 L 334846 R | | | | 343306 | 553240 | |
| Astra G (F69, F48, F08, T98) ALL ⊕ Sport sus. | 98 - 3.04 | | | | | | 343306 | 553240 | |
| Astra G (F35, T98) ALL Exc. Sport sus. | 98 - 3.04 | | 334847 L 334846 R | | | | 343307 | 553241▼ | |
| Astra G (F35, T98) ALL ⊕ Sport sus. | 98 - 3.04 | | | | | | 343307 | 553241▼ | |

1) Incl. VXR, VXR, 2.2 16V

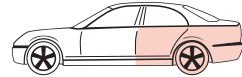
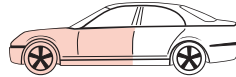

| MODEL FAHRZEUG MODELE | YEAR JAHR ANNEE | FRONT/VORNE/AVANT | | | | REAR/HINTEN/ARRIERE | | | |
|-----------------------------|-----------------------|-----------------------------|-----------------------------|--------------------------------|--|-----------------------------|-----------------------------|--------------------------------|--|
| | | PREMIUM Twin-tube Oil | EXCEL-G Twin-tube Gas | GAS-A-JUST Mono-tube Gas | | PREMIUM Twin-tube Oil | EXCEL-G Twin-tube Gas | GAS-A-JUST Mono-tube Gas | |

Vauxhall (GB)

Astra Exc. VXR /

| | | | | | | | | | |
|--|------------|--------|----------------------|----------------------|--|--|--------|--------|--|
| Astra G 1.6, 1.8 16V, 2.0 16V, 2.0 Turbo Exc. Sport sus. | (F07, T98) | 9.00 - | | 334847 L 334846 R | | | 343306 | 553240 | |
| | | | 935301 ¹⁾ | SM1313 ¹⁾ | | | | | |
| Astra G 1.6 16V, 1.8 16V Exc. Sport sus. | (F67, T98) | 9.00 - | | 334847 L 334846 R | | | 343306 | 553240 | |
| | | | 935301 | SM1313 ¹⁾ | | | | | |
| Astra G 2.2 16V ⊕ Sport sus. | (F67, T98) | 9.00 - | | | | | 343306 | 553240 | |
| | | | 935301 | SM1313 ¹⁾ | | | | | |

1) Incl. VXR, VXR, 2.2 16V

| | | | | | | | | | |
|--|-------|--------------|----------------------|----------------------|--|--|--------|--|--|
| Astra Mk V (H) ALL Incl. Exc. 2.0 Turbo (177 kW) Exc. Sport sus., , IDS sus. | (A04) | 1.04 - 3.11 | | 339703 L 339702 R | | | 344445 | | |
| | | | 910069 | SM1310 | | | | | |
| Astra Mk V (H) ALL ⊕ Sport sus., Exc. 2.0 Turbo (177 kW), , IDS sus. | (A04) | 1.04 - 3.11 | | 339703 L 339702 R | | | 344446 | | |
| | | | 910203 | SM1310 | | | | | |
| Astra Mk V (H) Sport Hatch ALL Incl. Sport sus., , Exc. 2.0 VXR, IDS sus. | (A04) | 2.05 - 11.10 | | 339703 L 339702 R | | | 344446 | | |
| | | | 910069 ¹⁾ | SM1310 | | | | | |
| | | | 910203 ²⁾ | | | | | | |
| Astra Mk V (H) Astra Mk V (H) Sport Hatch 2.0 Turbo (177 kW), 2.0 VXR Exc. IDS sus. | (A04) | 1.04 - 11.10 | | 339703 L 339702 R | | | | | |
| | | | 910069 | SM1310 | | | | | |
| Astra Mk V (H) ALL Incl. Exc. Sport sus., , , IDS sus. | (A04) | 8.04 - 10.12 | | 339703 L 339702 R | | | | | |
| | | | 910069 | SM1310 | | | | | |
| Astra Mk V (H) ALL ⊕ Sport sus., Exc. , , IDS sus. | (A04) | 8.04 - 10.12 | | 339703 L 339702 R | | | 344445 | | |
| | | | 910203 | SM1310 | | | | | |
| Astra Mk V (H) TwinTop 1.6, 1.6i 16V, 1.8 Exc. Sport sus., , IDS sus. | (A04) | 9.05 - 8.11 | | 339703 L 339702 R | | | | | |
| | | | 910069 | SM1310 | | | | | |

1) Exc. Sport sus.,

2) ⊕ Sport sus.,



| MODEL FAHRZEUG MODELE | YEAR JAHR ANNEE | FRONT/VORNE/AVANT | | | | REAR/HINTEN/ARRIERE | | | | | | | | | | | | | | | |
|---|-----------------------|-----------------------------|--|--------------------------------|--|---|-----------------------------|--------------------------------|--|---------|--|---|--|--|------------|--|------------|--|------------|-----|--|
| | | PREMIUM Twin-tube Oil | EXCEL-G Twin-tube Gas | GAS-A-JUST Mono-tube Gas | | PREMIUM Twin-tube Oil | EXCEL-G Twin-tube Gas | GAS-A-JUST Mono-tube Gas | | | | | | | | | | | | | |
| Vauxhall (GB) | | | | | | | | | | | | | | | | | | | | | |
| Astra Exc. VXR / | | | | | | | | | | | | | | | | | | | | | |
| Astra J (68, 69, 35) Incl. Exc. 2.0 BiTurbo CDTi, Astra GTC J Exc. Sport sus., , FlexRide sus. (GM) | 12.09- 7.12 | | 339372 L 339371 R | | | 348032 | | | | | | | | | | | | | | | |
| | | 910222 ¹⁾ SM1008 | | | | 910204 ²⁾ SM9908 910205 ³⁾ | | | | | | | | | | | | | | | |
| Astra J (68, 69, 35) ⊕ Sport sus., Exc. 1.4, 2.0 BiTurbo CDTi, Astra GTC J Exc. , FlexRide sus. (GM) | 12.09- 7.12 | | 339374 L 339373 R | | | 348032 | | | | | | | | | | | | | | | |
| | | 910222 ¹⁾ SM1008 | | | | 910204 ²⁾ SM9908 910205 ³⁾ | | | | | | | | | | | | | | | |
| Astra J (68, 35) 2.0 CDTi (118 kW) → A3999999 → A8999999 → AG999999 ⊕ | 12.09- | | 339372 L 339371 R | | | 348032 | | | | | | | | | | | | | | | |
| | | 910222 ¹⁾ SM1008 | | | | SM9908 | | | | | | | | | | | | | | | |
| Astra J (68, 69, 35) 1.4, 1.6, 1.6 SIDI, 1.6 Turbo 1.7 CDTi (kW : 81, 92, 96) Exc. , Sport sus., Exc. FlexRide sus. (GM), Astra GTC J | 8.12 - | | 339419 L 339418 R | | | 348032 | | | | | | | | | | | | | | | |
| | | 910222 ¹⁾ | | | | | | | | | | | | | | | | | | | |
| Astra GTC J (08) 1.4, 1.6, 1.6 SIDI 1.6 CDTi, 1.7 CDTi 2.0 CDTi, 2.0 BiTurbo CDTi Exc. FlexRide sus. (GM) | 10.11 - | | | | | 3440048 | | | | | | | | | | | | | | | |
| | | 910222 ¹⁾ SM1008 | | | | 910204 ²⁾ | | | | | | | | | | | | | | | |
| 1) <table border="1"> <tr> <td>Astra J </td> <td></td> <td rowspan="5">⊕</td> <td rowspan="5">Exc. FlexRide BiTurbo OPC VXR 2.0 (206 kW) GTC </td> </tr> <tr> <td></td> <td> B3000001 →</td> </tr> <tr> <td></td> <td> B8000001 →</td> </tr> <tr> <td></td> <td> BG000001 →</td> </tr> <tr> <td>GTC </td> <td></td> </tr> </table> 2) , ⊕ , : ALL 3) , ⊖ | | | | | | | | | | Astra J | | ⊕ | Exc. FlexRide BiTurbo OPC VXR 2.0 (206 kW) GTC | | B3000001 → | | B8000001 → | | BG000001 → | GTC | |
| Astra J | | ⊕ | Exc. FlexRide BiTurbo OPC VXR 2.0 (206 kW) GTC | | | | | | | | | | | | | | | | | | |
| | B3000001 → | | | | | | | | | | | | | | | | | | | | |
| | B8000001 → | | | | | | | | | | | | | | | | | | | | |
| | BG000001 → | | | | | | | | | | | | | | | | | | | | |
| GTC | | | | | | | | | | | | | | | | | | | | | |
| Astra K (B16) 1.0, 1.4, 1.4 Turbo (92 kW, 110 kW) 1.6 Biturbo, 1.6 Turbo 1.6 CDTi Incl. Removable tow bar Exc. | 7.15 - | | | | | 3440091 | | | | | | | | | | | | | | | |
| | | | | SM5888 ¹⁾ | | SM5887 ¹⁾ | | | | | | | | | | | | | | | |
| 1) Incl. | | | | | | | | | | | | | | | | | | | | | |





Vauxhall

| MODEL FAHRZEUG MODELE | YEAR JAHR ANNEE | FRONT/VORNE/AVANT | | | | REAR/HINTEN/ARRIERE | | | |
|---|---|-----------------------------|-----------------------------|--------------------------------|--|-----------------------------|-----------------------------|--------------------------------|--|
| | | PREMIUM Twin-tube Oil | EXCEL-G Twin-tube Gas | GAS-A-JUST Mono-tube Gas | | PREMIUM Twin-tube Oil | EXCEL-G Twin-tube Gas | GAS-A-JUST Mono-tube Gas | |
| Vauxhall (GB) | | | | | | | | | |
| Belmont | | | | | | | | | |
| ALL | 86 - 91 | 665036 | 365501 375009 | | | 443134 | 343047 | 553075▼ 243014 | |
| | | 915322▼ 910083 | | | | | | | |
| Calibra | | | | | | | | | |
| 2.0 i Exc. 16V, 16V-Turbo | 90 - 98 | 665063 | 365503 375032 | | | | 343259 353011▼ | | |
| | | 910083 | | | | | | | |
| 2.0 i 16V 2.0 i 16V Turbo 2.5 i 16V | 90 - 98 | | 365503 375032 | | | | 343259 353011▼ | | |
| | | 910083 | | | | | | | |
| Campo/ Brava | | | | | | | | | |
| (TFR Series) | 92 - | 443190 | | 553119 | | 443295 | | 553230 | |
| (TFS Series) | 92 - | 443216 | | 553171 | | 443295 | | 553230 | |
| Carlton, Viceroy, Omega Exc. | | | | | | | | | |
| Carlton Viceroy Carlton | 10.78 - 2.82 10.80 - 2.82 83 - 86 | 665035 | | | | 443027 | 343006 | | |
| | | 915322▼ 910083 | | | | | | | |
| Carlton Diesel | 83 - 86 | 665056 | | | | 443027 | 343006 | | |
| | | 915322▼ 910083 | | | | | | | |
| Carlton | 10.78 - 82 83 - 8.86 | 665035 | | | | 443031 | | | |
| | | 915322▼ 910083 | | | | | | | |
| Carlton 1.8, 2.0, 2.4 i, 2.3 D, 2.3 TD | 9.86 - 94 | 634022 L 634021 R | 334100 L▼ 334099 R▼ | | | 443234 | 343216 | 553162▼ | |
| | | 915329 | | | | | Exc. | | |
| Carlton 2.6 i, 3.0 i, 3000 | 9.86 - 94 | | 334100 L▼ 334099 R▼ | | | | 343216 | 553162▼ | |
| | | 915329 | | | | | Exc. | | |
| Carlton 2.0, 2.3 D, 2.3 TD, 2.4 i | 9.86 - 94 | 634022 L 634021 R | 334100 L▼ 334099 R▼ | | | | 344256 | 554088▼ | |
| | | 915329 | | | | | Exc. | | |
| Carlton 2.6 i, 3.0 i | 9.86 - 94 | | 334100 L▼ 334099 R▼ | | | | 344256 | 554088▼ | |
| | | 915329 | | | | | Exc. | | |



| MODEL FAHRZEUG MODELE | YEAR JAHR ANNEE | FRONT/VORNE/AVANT | | | | REAR/HINTEN/ARRIERE | | | |
|---|-----------------------|-----------------------------|-----------------------------|--------------------------------|--|-----------------------------|-----------------------------|--------------------------------|--|
| | | PREMIUM Twin-tube Oil | EXCEL-G Twin-tube Gas | GAS-A-JUST Mono-tube Gas | | PREMIUM Twin-tube Oil | EXCEL-G Twin-tube Gas | GAS-A-JUST Mono-tube Gas | |
| Vauxhall (GB) | | | | | | | | | |
| Carlton, Viceroy, Omega Exc. | | | | | | | | | |
| ALL Exc. | 94 - 7.03 | | 334903 | | | | 343216 | 553162▼ | |
| | | 915329 | SM1304 | | | | Exc. | | |
| ALL Exc. | 94 - 7.03 | | 334903 | | | | 344256 | 554088▼ | |
| | | 915329 | SM1304 | | | | Exc. | | |
| Cascada | | | | | | | | | |
| ALL | (W13) 2.13 - | | | | | | | SM9908 | |
| | | 910222 ¹⁾ | SM1008 | | | | | | |
| 1) Exc. | | | | | | | | | |
| Cavalier, Vectra | | | | | | | | | |
| ALL | 8.75 - 6.81 | 443026 | 343048▼ | | | 443027 | 343006 | | |
| | | | | 244029 | | | | 244030▼ | |
| ALL | 8.81 - 8.84 | 665042 | 365030▼ | | | 443230 | 343150▼ | | |
| | | 910083 | | | | | | | |
| ALL 1003027 → 5000001 → 6000001 → | 9.84 - 88 | 665057 | | | | 443230 | 343150▼ | | |
| | | 910083 | SM5498▼ | | | | | | |
| ALL | 8.81 - 8.84 | 665042 | 365030▼ | | | | | | |
| | | 910083 | | | | | | | |
| ALL 1003027 → 5000001 → 6000001 → | 9.84 - 88 | 665057 | | | | | | | |
| | | 910083 | SM5498▼ | | | | | | |
| ALL Exc. 2000-16V, 2.5 V6 | 9.88 - 95 | 665063 | 365503 | | | 443134 | 343047 | 553075▼ | |
| | | | 375032 | | | | | 243014 | |
| | | 910083 | SM1301 | | | | Exc. | | |
| 2000-16 V (2WD) (IF = 20XE, C 20XE) No. → NV199999 No. → N1999999 No. → N5999999 | 9.88 - 92 | 665063 | 365503 | | | 443234 | 343216 | 553162▼ | |
| | | 910083 | SM1301 | | | | Exc. | | |
| 2000-16 V (2WD) (IF = 20XE, C 20XE) No. → P1000001 No. → P5000001 No. → P7000001 | 93 - 95 | 665063 | 365503 | | | 443134 | 343047 | 553075▼ | |
| | | | 375032 | | | | | 243014 | |
| | | 910083 | SM1301 | | | | Exc. | | |
| 2.5 i V6 | 93 - 95 | | 365503 | | | | 343047 | 553075▼ | |
| | | | 375032 | | | | | 243014 | |
| | | 910083 | SM1301 | | | | Exc. | | |



| MODEL FAHRZEUG MODELE | YEAR JAHR ANNEE | FRONT/VORNE/AVANT | | | | REAR/HINTEN/ARRIERE | | | |
|--|-----------------------|---|-----------------------------|--------------------------------|--|--|-----------------------------|--------------------------------|--|
| | | PREMIUM Twin-tube Oil | EXCEL-G Twin-tube Gas | GAS-A-JUST Mono-tube Gas | | PREMIUM Twin-tube Oil | EXCEL-G Twin-tube Gas | GAS-A-JUST Mono-tube Gas | |
| Vauxhall (GB) | | | | | | | | | |
| Cavalier, Vectra | | | | | | | | | |
| (4WD) 1.8, 2.0 i, 2.0 i 16V, 2000-16V 2.0 i 16V Turbo | 9.88 - 95 | 665063 | 365503 | | | 443234 | 343216 | 553162▼ | |
| | | 910083 | SM1301 | | | | Exc. | | |
| Chevette | | | | | | | | | |
| ALL | 6.76 - 84 | 443026 | 343048▼ | | | 443027 | 343006 | | |
| | | | | 244029 | | | | 244030▼ | |
| ALL | 10.75 - 84 | 443026 | 343048▼ | | | 443025 | | | |
| Corso C | | | | | | | | | |
| 1.0, 1.2, 1.7 TDi, 1.3 CDTi Incl. Twinport Exc. , Sport sus. | 9.00 - | | 333756 L 333755 R | | | | 343350 | | |
| | | 935303 | SM1313 | | | | | | |
| 1.4, 1.8, 1.7 DTi, 1.7 CDTi Incl. Twinport Exc. , Sport sus. | 9.00 - | | 333756 L 333755 R | | | | 343351 | | |
| | | 935303 | SM1313 | | | | | | |
| Corso Mk III | | | | | | | | | |
| 1.0, 1.2, 1.2 LPG, 1.4, 1.4 LPG Exc. Sport sus. | 7.06 - | | 339715 L 339714 R | | | | 343459 | | |
| | | 910134 ¹⁾ SM1820 910203 ²⁾ | | | | 913121 SM9806 L SM9805 R | | | |
| 1.3 CDTi, 1.7 CDTi Exc. Sport sus. | 7.06 - | | 339717 L 339716 R | | | | 343459 | | |
| | | 910134 ¹⁾ SM1820 910203 ²⁾ | | | | 913121 SM9806 L SM9805 R | | | |
| 1.6 VXR, 1.6 SRI | 2.07 - | | | | | | | | |
| | | 910134 SM1820 | | | | 913121 SM9806 L SM9805 R | | | |
| 1) Exc. 2) | | | | | | | | | |
| Corso Mk IV (E) | | | | | | | | | |
| ALL Exc. 1.6 VXR, Sport sus., , | (X15) 8.14 - | | 339715 L 339714 R | | | | 343459 | | |
| | | 910134 ¹⁾ SM1820 | | | | 910277 ¹⁾ SM9806 L SM9805 R | | | |
| ALL Sport sus., , | (X15) 8.14 - | | 339715 L 339714 R | | | | 3430078 | | |
| Exc. 1.6 VXR | | 910134 ¹⁾ SM1820 | | | | 910277 ¹⁾ SM9806 L 910276 ²⁾ SM9805 R | | | |
| 1) Normal sus., 2) Sport sus., | | | | | | | | | |



| MODEL FAHRZEUG MODELE | YEAR JAHR ANNEE | FRONT/VORNE/AVANT | | | | REAR/HINTEN/ARRIERE | | | | | | | | | | | | |
|---|----------------------------------|-----------------------------|-----------------------------|--------------------------------|--|-----------------------------|-----------------------------|--------------------------------|--|--|--|------|--|---|---------|--|--|-----------|
| | | PREMIUM Twin-tube Oil | EXCEL-G Twin-tube Gas | GAS-A-JUST Mono-tube Gas | | PREMIUM Twin-tube Oil | EXCEL-G Twin-tube Gas | GAS-A-JUST Mono-tube Gas | | | | | | | | | | |
| Vauxhall (GB) | | | | | | | | | | | | | | | | | | |
| Corsa Mk IV (E) | | | | | | | | | | | | | | | | | | |
| 1.6 VXR Incl. Sport sus. | (X15) | 4.15 - | | 3348081 L 3348080 R | | | | SM9806 L SM9805 R | | | | | | | | | | |
| Crossland X | | | | | | | | | | | | | | | | | | |
| | (P17) | 3.17 - | | 3338052 L 3338051 R | | | 3438001 | | | | | | | | | | | |
| Frontera | | | | | | | | | | | | | | | | | | |
| Incl. Sport | (52SU, 53MW, 5JMW) | 10.91 - 9.95 | 444120 | 344227 | | 444122 | 344228 | | | | | | | | | | | |
| Incl. Sport | (54/55/5B/5K SU, 54/55/5B/5K MW) | 9.95 - 10.98 | | 344227 | | | 344229 | | | | | | | | | | | |
| Incl. Sport | | 10.98 - | | 344298 | | | 344299 | | | | | | | | | | | |
| Grandland X | | | | | | | | | | | | | | | | | | |
| Exc. Hybrid | (A18) | 6.17 - | | 3348091 | | | 3448001 | | | | | | | | | | | |
| 1.6 Turbo Hybrid | (A18) | 6.19 - | | 3348091 | | | | | | | | | | | | | | |
| Insignia | | | | | | | | | | | | | | | | | | |
| 1.4, 1.6, 1.8, 1.6 T, 2.0 T, 2.8 V6 T, 2.0 CDTi 2.0 Biturbo CDTi, 2.0 Turbo E85 Exc. VXR, Sri, Sport sus., Exc. Flexride sus. | | 7.08 - | | 339376 L 339375 R | | | 349136 | | | | | | | | | | | |
| 1.4, 1.6, 1.8, 1.6 T, 2.0 T, 2.8 V6 T, 2.0 CDTi 2.0 Biturbo CDTi, 2.0 Turbo E85 Sri, Sport sus., Exc. VXR, Flexride sus. | | 7.08 - | | 339376 L 339375 R | | | | SM5652 L SM5651 R | | | | | | | | | | |
| 1.6, 1.8, 1.6 T, 2.0 T, 2.8 V6 T, 2.0 CDTi 2.0 Biturbo CDTi Incl. Sri, Sport sus., Exc. VXR, Flexride sus. | | 7.08 - | | 339376 L 339375 R | | | | SM5652 L SM5651 R | | | | | | | | | | |
| 1.4 LPG, 2.8 VXR, 1.6 CDTi | | 7.09 - | | 910176 ¹⁾ | | | | SM5652 L SM5651 R | | | | | | | | | | |
| <p>1) Exc. , VXR</p> <p>2) <table border="1"> <tr> <td></td> <td></td> <td>Date</td> </tr> <tr> <td></td> <td>→ </td> <td>→ 07.13</td> </tr> <tr> <td></td> <td></td> <td>→ 08.13 →</td> </tr> </table></p> | | | | | | | | | | | | Date | | → | → 07.13 | | | → 08.13 → |
| | | Date | | | | | | | | | | | | | | | | |
| | → | → 07.13 | | | | | | | | | | | | | | | | |
| | | → 08.13 → | | | | | | | | | | | | | | | | |



Vauxhall

| MODEL FAHRZEUG MODELE | YEAR JAHR ANNEE | FRONT/VORNE/AVANT | | | REAR/HINTEN/ARRIERE | | |
|---|--|--|--|--------------------------------|-----------------------------|--|--------------------------------|
| | | PREMIUM Twin-tube Oil | EXCEL-G Twin-tube Gas | GAS-A-JUST Mono-tube Gas | PREMIUM Twin-tube Oil | EXCEL-G Twin-tube Gas | GAS-A-JUST Mono-tube Gas |
| Vauxhall (GB) | | | | | | | |
| Insignia Sports Tourer | | | | | | | |
| (2WD) (4WD) 1.4, 1.6, 1.8, 1.6 T, 2.0 T, 2.8 V6 T 2.0 CDTi, 2.0 Biturbo CDTi Incl. Sri, Sport sus., Exc. VXR, Flexride sus. | 7.08 - 5.17 | | 339376 L 339375 R | | | | |
| | | 910176 ¹⁾ | SM5610 ²⁾ SM1076 ²⁾ | | | SM5652 L ³⁾ SM5651 R ³⁾ | |
| (2WD) (4WD) 1.4 LPG, 2.8 VXR, 1.6 CDTi Exc. | 7.09 - 5.17 | | | | | SM5652 L ³⁾ SM5651 R ³⁾ | |
| 1) Exc. (4WD), VXR 2) Date | | | | | | | |
| SM5610 → D1999999 → 07.13 | | | | | | | |
| SM1076 E1000001 → 08.13 → | | | | | | | |
| 3) Exc. | | | | | | | |
| Insignia Country Tourer | | | | | | | |
| (2WD) (4WD) Exc. | 7.08 - 5.17 | | | | | SM5652 L SM5651 R | |
| Insignia Mk II | | | | | | | |
| (2WD) (Z18) 1.5, 1.6 Turbo, 1.6 D, 2.0 D Incl. Exc. FlexRide sus. (GM) | 3.17 - | | | | 3440073 | | |
| Insignia Mk II Country Tourer | | | | | | | |
| (2WD) (Z18) 2.0 D Incl. Exc. FlexRide sus. (GM) | 3.17 - | | | | 3440073 | | |
| Insignia Mk II Sports Tourer | | | | | | | |
| (2WD) (Z18) 1.5, 1.6 Turbo, 1.6 D, 2.0 D Incl. Exc. FlexRide sus. (GM) | 3.17 - | | | | 3440073 | | |
| Meriva Mk I (A) | | | | | | | |
| 1.3 CDTi (X03) 1.6 i 1.6 i 16V 1.8 i 1.7 CDTi 1.7 DTi | 9.03 - 5.03 - 5.03 - 5.03 - 8.03 - 5.03 - | | 333756 L 333755 R | | | 343308 553242 | |
| | | 935303 | SM1313 | | | | |
| 1.6 Turbo (X03) | 5.06 - 6.10 | | | | | | |
| | | 935303 | SM1313 | | | | |
| Meriva Mk II (B) | | | | | | | |
| Incl. , Hill-Start Assistant (S10) | 6.10 - | | 339827 L 339826 R | | | 344715 | |
| | | 910203 ¹⁾ 910069 ²⁾ | SM1036 | | | | |
| 1) Exc. 2) | | | | | | | |



| MODEL FAHRZEUG MODELE | YEAR JAHR ANNEE | FRONT/VORNE/AVANT | | | | REAR/HINTEN/ARRIERE | | | |
|--|---------------------------|-----------------------------|-----------------------------|--------------------------------|--|--|-----------------------------|--------------------------------|--|
| | | PREMIUM Twin-tube Oil | EXCEL-G Twin-tube Gas | GAS-A-JUST Mono-tube Gas | | PREMIUM Twin-tube Oil | EXCEL-G Twin-tube Gas | GAS-A-JUST Mono-tube Gas | |
| Vauxhall (GB) | | | | | | | | | |
| Mokka / Mokka X | | | | | | | | | |
| (J13) | 6.12 - | | 3340214 L 3340213 R | | | 3440008 ▼ 3440035 | | | |
| | | | SM1008 | | | 912049 ¹⁾ 912048 ²⁾ | | | |
| 1) : 6.12 → 2) : →12.16 : 1.17 → | | | | | | | | | |
| Monterey | | | | | | | | | |
| (UBS) | 92 - 3.98 | | 344279 | | | 344229 | | | |
| Nova, Corsa | | | | | | | | | |
| Nova Exc. GTE, GSi | 83 - 2.93 | 633831 | 333831 <u>323034</u> | | | 443225 | 343265 <u>353012</u> | 553155 ▼ | |
| | | | 910083 SM1305 | | | | | | |
| Nova GTE, GSi | 83 - 2.93 | | 333831 <u>323034</u> | | | | 343265 <u>353012</u> | 553155 ▼ | |
| | | | 910083 SM1305 | | | | | | |
| Corsa Exc. GSi, Sport | 3.93 - 9.00 | 633831 | 333831 <u>323034</u> | | | 443225 | 343265 <u>353012</u> | 553155 ▼ | |
| | | | 910083 SM2302 | | | | | | |
| Corsa GSi, Sport | 3.93 - 9.00 | | 333831 <u>323034</u> | | | | 343265 <u>353012</u> | 553155 ▼ | |
| | | | 910083 SM2302 | | | | | | |
| Royale, Senator Exc. | | | | | | | | | |
| Exc. | 10.78 - 2.82 78 - 8.87 | 665056 | | | | 343044 | | | |
| | | | 915322 ▼ 910083 | | | | | | |
| 2.3 TD, 2.6 | 9.87 - 95 | 634022 L 634021 R | 334100 L ▼ 334099 R ▼ | | | 443234 | 343216 | 553162 ▼ | |
| | | | 915329 SM1304 | | | | Exc. | | |
| 2.5 | 9.87 - 95 | 634022 L 634021 R | 334100 L ▼ 334099 R ▼ | | | 443234 | 343216 | 553162 ▼ | |
| | | | 915329 SM1304 | | | | Exc. | | |
| 3.0 i, 3.0 i 24 V | 9.87 - 95 | | 334100 L ▼ 334099 R ▼ | | | | 343216 | 553162 ▼ | |
| | | | 915329 SM1304 | | | | Exc. | | |



Vauxhall

| MODEL FAHRZEUG MODELE | YEAR JAHR ANNEE | FRONT/VORNE/AVANT | | | | REAR/HINTEN/ARRIERE | | | |
|---|-----------------------|-----------------------------|--|--------------------------------|--|-----------------------------|-----------------------------|--------------------------------|--|
| | | PREMIUM Twin-tube Oil | EXCEL-G Twin-tube Gas | GAS-A-JUST Mono-tube Gas | | PREMIUM Twin-tube Oil | EXCEL-G Twin-tube Gas | GAS-A-JUST Mono-tube Gas | |
| Vauxhall (GB) | | | | | | | | | |
| Signum | | | | | | | | | |
| 1.8, 2.0 Turbo, 2.2, 2.8 V6 Turbo, 3.2 V6 1.9 CDTI (incl. 16V), 1.9 Turbo D, 2.0 DTI 2.2 DTI, 3.0 CDTI, 3.0 V6 CDTI Exc. Sport sus, | 4.02 - 5.08 | | 334633 L ¹⁾ ▼ 334632 R ¹⁾ ▼ 3348050 L ¹⁾ 3348049 R ¹⁾ 334635 L ²⁾ 334634 R ²⁾ | | | | | 553307 | |
| | | 910069 | | | | | | | |
| 1) → 48999999 2) 51000001 → | | | | | | | | | |
| Sintra | | | | | | | | | |
| 2.2 i, 2.2 DTi, 3.0 i V6 Exc. | 3.96 - 12.99 | | 334227 | | | | 344338 | | |
| | | SM5143 | | | | | | | |
| Tigra | | | | | | | | | |
| | 94 - 1.01 | | 333831 323034 | | | | 343265 353012 | 553155▼ | |
| | | 910083 | | | | | | | |
| Tigra Twintop | | | | | | | | | |
| | 7.04 - | | | | | | | | |
| | | SM1313 | | | | | | | |
| Vectra B | | | | | | | | | |
| 1.6 i, 1.8 i, 1.7 TD, 2.0 i, 2.0 Di, 2.0 DTi 2.2 i, 2.2 DTi Incl. 16V Exc. Sport sus. | 9.95 - 3.02 | | 333716 L 333715 R | | | | 341841 ¹⁾ | | |
| | | 935301 | | | | 935302 | | | |
| 2.5i V6, 2.5 i GSi, 2.6 i V6 Exc. Sport sus. | 9.95 - 3.02 | | 334610 L 334609 R | | | | 341841 ¹⁾ | | |
| | | 935301 | | | | 935302 | | | |
| Sport sus. | 9.95 - 3.02 | | 334610 L 334609 R | | | | 341841 ¹⁾ | | |
| | | 935301 | | | | 935302 | | | |
| 1) Exc. | | | | | | | | | |
| Vectra C | | | | | | | | | |
| 1.6, 1.6 16V, 1.8, 1.8 16V 2.0 16V Turbo, 2.2 direct, 2.2 16V 2.8 V6 Turbo, 3.2 V6 1.9 CDTI (incl. 16V), 2.0 DTI 16V 2.2 DTI 16V, 3.0 CDTI, 3.0 V6 CDTI 1.8 16V Dualfuel Exc. Sport sus, H/D, | 4.02 - 10.08 | | 334633 L ¹⁾ ▼ 334632 R ¹⁾ ▼ 3348050 L ¹⁾ 3348049 R ¹⁾ 334635 L ²⁾ 334634 R ²⁾ | | | | | 553307 | |
| | | 910069 | | | | | | | |
| 1) → 48999999 2) 51000001 → | | | | | | | | | |



| MODEL FAHRZEUG MODELE | YEAR JAHR ANNEE | FRONT/VORNE/AVANT | | | | REAR/HINTEN/ARRIERE | | | |
|--|-----------------------|---|-----------------------------|--------------------------------|--|-----------------------------|-----------------------------|--------------------------------|--|
| | | PREMIUM Twin-tube Oil | EXCEL-G Twin-tube Gas | GAS-A-JUST Mono-tube Gas | | PREMIUM Twin-tube Oil | EXCEL-G Twin-tube Gas | GAS-A-JUST Mono-tube Gas | |
| Vauxhall (GB) | | | | | | | | | |
| Vectra C | | | | | | | | | |
| 1.6, 1.6 16V, 1.8, 1.8 16V 2.0 16V Turbo, 2.2 direct, 2.2 16V 2.8 V6 Turbo, 3.2 V6 1.9 CDTi (incl. 16V), 2.0 DTI 16V 2.2 DTI 16V, 3.0 CDTi, 3.0 V6 CDTi 1.8 16V Dualfuel ⊕ H/D | 4.02 - 10.08 | | | | | | | | |
| | | 910071 | | | | | | | |
| Viva | | | | | | | | | |
| 1.0 (55 kW), 1.0 LPG Incl. IDS sus. (C16) | 1.15 - 3.18 | | | | | | 3430069 | | |
| | | SM1054 | | | | | | | |
| 1.0 (54 kW) (C16) | 1.18 - 3.19 | | | | | | | | |
| | | SM1054 | | | | | | | |
| Zafira I | | | | | | | | | |
| ALL Exc. 2.0 VXR, Self Leveling (⊕) | (F75) 11.98 - 8.05 | | 334845 L 334844 R | | | | 343308 | 553242 | |
| | | 935301 SM1313 | | | | | | | |
| 2.0 VXR (F75) | 9.01 - 6.05 | | | | | | | | |
| | | 935301 SM1313 | | | | | | | |
| Zafira II | | | | | | | | | |
| 1.6, 1.6 CNG, 1.6 CNGT (M75) 1.8, 2.0, 2.2 1.7 CDTi, 1.9 CDTi Exc. , Self Leveling (⊕), IDS | 4.05 - | | 339703 L 339702 R | | | | 349018 | | |
| | | 910069 ¹⁾ SM1310 910203 ²⁾ | | | | | | | |
| 1) ⊕ 2) Exc. | | | | | | | | | |
| Zafira Tourer Mk III | | | | | | | | | |
| 1.4, 1.6 CDTi, 1.6 SIDI, 1.8 (P12) 2.0 CDTi (kW : 81, 96, 118, 121) Incl. Exc. Sport sus., , FlexRide sus. (GM) | 10.11 - | | 339372 L 339371 R | | | | 349234 | | |
| | | 910222 SM1008 | | | | 910204 SM9908 | | | |
| 1.4, 1.8 (P12) 2.0 CDTi (kW : 81, 96, 118, 121) ⊕ Sport sus., Exc. , FlexRide sus. (GM) | 10.11 - | | 339374 L 339373 R | | | | 3440048 | | |
| | | 910222 SM1008 | | | | 910204 SM9908 | | | |
| 1.4 LPG, 1.6 CNG (P12) Exc. FlexRide sus. (GM) | 10.11 - 12.12 | | 339374 L 339373 R | | | | 349234 | | |
| | | 910222 SM1008 | | | | 910204 SM9908 | | | |
| 1.4 LPG, 1.6 CNG (P12) Exc. FlexRide sus. (GM) | 1.13 - | | 3340161 L 3340160 R | | | | 349234 | | |
| | | 910222 SM1008 | | | | 910204 SM9908 | | | |
| 2.0 CDTi (125 kW), 2.0 BiTurbo CDTi (P12) Exc. Sport sus., , FlexRide sus. (GM) | 1.13 - | | | | | | 349234 | | |
| | | 910222 SM1008 | | | | 910204 SM9908 | | | |



Vauxhall

| MODEL FAHRZEUG MODELE | YEAR JAHR ANNEE | FRONT/VORNE/AVANT | | | | REAR/HINTEN/ARRIERE | | | |
|-----------------------------|-----------------------|-----------------------------|-----------------------------|--------------------------------|--|-----------------------------|-----------------------------|--------------------------------|--|
| | | PREMIUM Twin-tube Oil | EXCEL-G Twin-tube Gas | GAS-A-JUST Mono-tube Gas | | PREMIUM Twin-tube Oil | EXCEL-G Twin-tube Gas | GAS-A-JUST Mono-tube Gas | |

Vauxhall (GB)

Zafira Tourer Mk III

| | | | | | | | | |
|---|--------|--------|------------------------|--|--|---------|--------|--|
| 1.6 CDTi, 1.6 SIDI (P12) 2.0 CDTi (125 kW), 2.0 BiTurbo CDTi ⊕ Sport sus., Exc. , FlexRide sus. (GM) | 1.13 - | | 3340161 L 3340160 R | | | 3440048 | | |
| | | 910222 | SM1008 | | | 910204 | SM9908 | |

Vauxhall Commercial (GB)

Combo

| | | | | | | | | |
|--|---------------|--------|----------------------|----------------------|--|--------|--------|--------|
| | 10.93 - 10.01 | 633831 | 333831 | | | 443233 | 343227 | |
| | | 910083 | SM2302 | | | | | |
| Exc. | 10.01 - | | 333756 L 333755 R | | | | 343308 | 553242 |
| | | 935303 | SM1313 | | | | | |
| Combo Mk III 1.4, 1.4 CNG, 1.3 CDTi (66 kW) 1.6 CDTi (kW : 66, 74, 77), 2.0 CDTi | (D) 11.11 - | | | SM1822 L SM1821 R | | | | |

Movano

| | | | | | | | | |
|-----------------------|-----------|--|--------|--|--|--|--------|--|
| Exc. (U9), (H9) | 7.98 - 10 | | 344306 | | | | 344307 | |
|-----------------------|-----------|--|--------|--|--|--|--------|--|

Movano (B)

| | | | | | | | | |
|-------------------|------------|----------------------|--------|--|--|--|--------|--|
| 2.3 CDTi ⊕ | (B) 5.10 - | | 335835 | | | | 345702 | |
| | | 910278 ¹⁾ | SM1019 | | | | | |
| 2.3 CDTi ⊕ | (B) 5.10 - | | 335835 | | | | 345703 | |
| | | 910278 ¹⁾ | SM1019 | | | | | |
| 2.3 CDTi ⊕ | (B) 5.10 - | | 335837 | | | | 345704 | |
| | | 910278 ¹⁾ | SM1019 | | | | | |

1) : ⊕
 : ⊕

Vivaro

| | | | | | | | | |
|----------------------|--------------|--------|--------|--|--|--|--------|--|
| | 5.01 - | | 335803 | | | | 344803 | |
| | | 910039 | SM1511 | | | | | |
| Incl. H/D, , | (X82) 5.14 - | | 335803 | | | | 344803 | |
| | | 910039 | SM1511 | | | | | |



| MODEL FAHRZEUG MODELE | YEAR JAHR ANNEE | FRONT/VORNE/AVANT | | | | REAR/HINTEN/ARRIERE | | | |
|--|-----------------------|-----------------------------|-----------------------------|--|---------------------------------|-----------------------------|--|--------------------------------|--|
| | | PREMIUM Twin-tube Oil | EXCEL-G Twin-tube Gas | GAS-A-JUST Mono-tube Gas | | PREMIUM Twin-tube Oil | EXCEL-G Twin-tube Gas | GAS-A-JUST Mono-tube Gas | |
| Vauxhall Commercial (GB) | | | | | | | | | |
| Vivaro C / Vivaro Life | | | | | | | | | |
| | (K0) | 3.19 - | | 3348085 ¹⁾ 3348084 ²⁾ | | | 3458001 | | |
| 1) | | 2) | | | | | | | |
| Volkswagen (D) | | | | | | | | | |
| Amarok | | | | | | | | | |
| | | 9.10 - | | | | | 349144 | | |
| 2.0 BitDi, 2.0 TDi, 2.0 TSi | | | | | | | | | |
| Arteon , Arteon Shooting Brake | | | | | | | | | |
| | (3H_) | 3.17 - | | 3358015 | | | 3448024 | | |
| Incl. Exc. TSI R, Sport sus., | | | | | | | | | |
| | | | | | | | | | |
| 1) | | | | | | | | | |
| Beetle | | | | | | | | | |
| | (5C1, 5C7) | 4.11 - | | 334834 ¹⁾ 335808 ²⁾ | | | 3430019 ³⁾ 3440030 ⁴⁾ | | |
| Exc. Sport sus., Comfort sus. | | | | | | | | | |
| | (5C1, 5C7) | 4.11 - | | 335808 ²⁾ | | | 3430019 ³⁾ 3440030 ⁴⁾ | | |
| Exc. Comfort sus. | | | | | | | | | |
| | | | | | | | | | |
| | (5C1) | 4.11 - | | 335808 ²⁾ | | | | | |
| Exc. Sport sus. | | | | | | | | | |
| | | | | | | | | | |
| 1) | | 2) | | 3) | | | | | |
| | | | | 4) | | | | | |
| Bora , Jetta IV | | | | | | | | | |
| | (1J) | 9.97 - 5.05 | 633713 | 333713 324016 | | | 343348 | 553206 243037 | |
| 1.4, 1.6 Exc. Sport sus., | | | | | | | | | |
| | | | | | | | | | |
| 1) SM9703 : OE p/n = 1J0513353D | | | | | 2) SM9704 : OE p/n = 1J0513353B | | | | |



| MODEL FAHRZEUG MODELE | YEAR JAHR ANNEE | FRONT/VORNE/AVANT | | | | REAR/HINTEN/ARRIERE | | | |
|-----------------------------|-----------------------|-----------------------------|-----------------------------|--------------------------------|--|-----------------------------|-----------------------------|--------------------------------|--|
| | | PREMIUM Twin-tube Oil | EXCEL-G Twin-tube Gas | GAS-A-JUST Mono-tube Gas | | PREMIUM Twin-tube Oil | EXCEL-G Twin-tube Gas | GAS-A-JUST Mono-tube Gas | |

Volkswagen (D)

Bora , Jetta IV

| | | | | | | | | | |
|---|------|-------------|--------|------------------|--|--|--------|------------------|--|
| (2WD) 1.8, 1.8 Turbo, 2.0, 2.3, 1.9 SDI, 1.9 TDI Exc. Sport sus, | (1J) | 9.97 - 5.05 | 634812 | 334812 324016 | | | 343348 | 553206 243037 | |
| (2WD) ALL + Sport sus. Exc. 2.8 V6 | (1J) | 9.97 - 5.05 | | 334812 324016 | | | | 553206 243037 | |
| (2WD) ALL + Exc. 2.8 V6 | (1J) | 9.97 - 5.05 | 634812 | 334812 | | | | 553206 243037 | |
| (4WD) 1.8, 2.3, 1.9 TDI Exc. Sport sus, , 2.8 V6 | (1J) | 9.97 - 5.99 | 634812 | 334812 324016 | | | 343310 | 553243 | |
| (4WD) ALL + Sport sus. Exc. 2.8 V6 | (1J) | 9.97 - 5.99 | | 334812 324016 | | | 343310 | 553243 | |
| (4WD) ALL + Exc. 2.8 V6 | (1J) | 9.97 - 5.99 | 634812 | 334812 | | | 344301 | | |
| (4WD) 1J-X-9998-000 → Exc. Sport sus, , 2.8 V6 | (1J) | 99 - 5.05 | | 334670 | | | 343310 | 553243 | |
| (4WD) ALL + Sport sus. Exc. 2.8 V6 | (1J) | 99 - 5.05 | | 334670 | | | 343310 | 553243 | |
| (4WD) ALL + Exc. 2.8 V6 | (1J) | 99 - 5.05 | | 334670 | | | 344301 | | |
| 2.8 V6 (4WD) | (1J) | 99 - 5.05 | | | | | | | |

Bora Variant

| | | | | | | | | | |
|---|------|-----------|--------|--------|--|--|--------|--|--|
| (2WD) 1.4, 1.6 Exc. Sport sus, | (1J) | 99 - 5.05 | 633713 | 333713 | | | 343298 | 553232▼ | |
| | | | 915415 | SM1708 | | | 915400 | SM9703 ¹⁾ SM9704 ²⁾ | |

1) SM9703 : OE p/n = 1J0513353D

2) SM9704 : OE p/n = 1J0513353B



| MODEL FAHRZEUG MODELE | YEAR JAHR ANNEE | FRONT/VORNE/AVANT | | | | REAR/HINTEN/ARRIERE | | | |
|-----------------------------|-----------------------|-----------------------------|-----------------------------|--------------------------------|--|-----------------------------|-----------------------------|--------------------------------|--|
| | | PREMIUM Twin-tube Oil | EXCEL-G Twin-tube Gas | GAS-A-JUST Mono-tube Gas | | PREMIUM Twin-tube Oil | EXCEL-G Twin-tube Gas | GAS-A-JUST Mono-tube Gas | |

Volkswagen (D)

Bora Variant

| | | | | | | | | |
|---|------|-----------|------------------|----------------------------|--|--------|--|--|
| 1.8 T, 2.3, 1.9 SDI, 1.9 TDI Exc. Sport sus, | (1J) | 99 - 5.05 | 634812 915415 | 334812 SM1708 | | 915400 | 553232 SM9703 ¹⁾ SM9704 ²⁾ | |
| ⊕ Sport sus. | (1J) | 99 - 5.05 | 915415 | 334812 324016 SM1708 | | 915400 | 553206 243037 SM9703 ¹⁾ SM9704 ²⁾ | |
| ⊕ | (1J) | 99 - 5.05 | 634812 915415 | 334812 SM1708 | | 915400 | 553232 SM9703 ¹⁾ SM9704 ²⁾ | |
| Exc. Sport sus, , 2.8 V6 | (1J) | 99 - 5.05 | 915415 | 334670 SM1708 | | 915400 | 343310 553243 SM9703 ¹⁾ SM9704 ²⁾ | |
| ⊕ Sport sus. Exc. 2.8 V6 | (1J) | 99 - 5.05 | 915415 | 334670 SM1708 | | 915400 | 343310 553243 SM9703 ¹⁾ SM9704 ²⁾ | |
| ⊕ Exc. 2.8 V6 | (1J) | 99 - 5.05 | 915415 | 334670 SM1708 | | 915400 | 344301 SM9703 ¹⁾ SM9704 ²⁾ | |

1) SM9703 : OE p/n = 1J0513353D 2) SM9704 : OE p/n = 1J0513353B

Caddy Life, Caddy Maxi Life → Volkswagen Commercial

| | | | | | | | | |
|--|--|--|--|--|--|--|--|--|
| | | | | | | | | |
|--|--|--|--|--|--|--|--|--|

Corrado

| | | | | | | | | |
|--------------------------------------|-------|--------------|------------------|--|--|--------|--|--|
| 1.8 16V, 1.8 G60 2.0 i, 2.0 i 16V | (53i) | 8.87 - 12.95 | 634810 915401 | 334810 324025 SM1700 ²⁾ SM1704 ³⁾ | | 910087 | 343258 ¹⁾ (SP-001) 353013 ¹⁾ (SP-001) SM9700 | |
| VR 6 | (53i) | 8.91 - 12.95 | 634810 915401 | 334810 324025 SM1704 ³⁾ | | 910087 | 343191 ¹⁾ (SP-001) 353013 ¹⁾ (SP-001) SM9700 | |

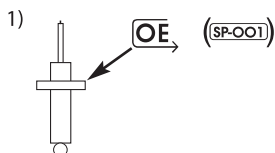

| | Year | KYB |
|---------|--------------|--------|
| 1.8 16V | 4.89 - 7.92 | SM1700 |
| 1.8 G60 | 9.88 - 9.93 | SM1700 |
| 2.0 16V | 8.91 - 7.94 | SM1700 |
| 2.0 16V | 8.94 - 12.95 | SM1704 |



| MODEL FAHRZEUG MODELE | YEAR JAHR ANNEE | FRONT/VORNE/AVANT | | | | REAR/HINTEN/ARRIERE | | | |
|--|------------------------------|-----------------------------|--|--------------------------------|--|----------------------------------|--|--------------------------------|--|
| | | PREMIUM Twin-tube Oil | EXCEL-G Twin-tube Gas | GAS-A-JUST Mono-tube Gas | | PREMIUM Twin-tube Oil | EXCEL-G Twin-tube Gas | GAS-A-JUST Mono-tube Gas | |
| Volkswagen (D) | | | | | | | | | |
| Eos (1F7) | | | | | | | | | |
| 1.4 TSi, 1.6 FSi, 2.0 FSi 2.0 TFSi, 2.0 TSi, 2.0 TDi, 2.0 TDi 16V 3.2 V6, 3.6 V6 Incl. Sport sus. | (1F7) 3.06 - | | 335808 325700 | | | | 349022 | | |
| | | 910059 ¹⁾ SM1714 | | | | 915400 SM9711 | | | |
| 1) Normal sus. | | 2) Sport sus. | | | | | | | |
| Fox (5Z1) | | | | | | | | | |
| 1.2 i, 1.4 i, 1.4 TDi | (5Z1) 4.05 - | | 334835 324702 | | | | 343438 | | |
| | | 910084 SM1713 | | | | 915400 SM9704 | | | |
| Golf I, Jetta I Exc. | | | | | | | | | |
| Golf Jetta Exc. GTI, Turbo Diesel | 73 - 8.83 8.78 - 2.84 | 663009 | 363001 373012 | | | 441018 443172 ¹⁾ ▼ | 341007 351007 | | |
| | | 910088 SM5508 | | | | | | | |
| Golf GTI, Turbo-Diesel Jetta GTI, Turbo-Diesel | 9.76 - 12.83 9.76 - 2.84 | | 363001 373012 | | | | 341007 351007 | | |
| | | 910088 SM5508 | | | | | | | |
| 1) | | | | | | | | | |
| Golf II, Jetta II Exc. | | | | | | | | | |
| Golf Jetta → 1 G LW 320000 Exc. GTI, GTI 16V, G60 | 8.83 - 12.89 3.84 - 12.89 | 664014 ¹⁾ | 364014 ¹⁾ 374006 ¹⁾ ▼ | | | 443800 ²⁾ | 343191 ²⁾ 353013 ²⁾ | | |
| | | 915401 SM1701 ▼ SM1700 | | | | 910087 SM9700 | | | |
| | | 633276 | 333712 324025 | | | | | | |
| | | 915401 SM1701 ▼ SM1700 | | | | 910087 SM9700 | | | |



| MODEL FAHRZEUG MODELE | YEAR JAHR ANNEE | FRONT/VORNE/AVANT | | | | REAR/HINTEN/ARRIERE | | | |
|---|------------------------------|-----------------------------|--|--------------------------------|--|------------------------------------|--|--------------------------------|--|
| | | PREMIUM Twin-tube Oil | EXCEL-G Twin-tube Gas | GAS-A-JUST Mono-tube Gas | | PREMIUM Twin-tube Oil | EXCEL-G Twin-tube Gas | GAS-A-JUST Mono-tube Gas | |
| Volkswagen (D) | | | | | | | | | |
| Golf II, Jetta II Exc. | | | | | | | | | |
| (2WD) Golf Jetta 1 G LW 320001 → Exc. GTI, GTI 16V, G60 | 1.90 - 92 | 633276 | 333712 324025 | | | 443800 ²⁾ (SP-001) | 343191 ²⁾ (SP-001) 353013 ²⁾ (SP-001) | | |
| | | 915401 | SM1701 ▼ SM1700 | | | 910087 | SM9700 | | |
| (2WD) Golf GTI Exc. 16V, G60 Jetta GTi, GT 16V | 1.84 - 12.89 3.84 - 12.89 | | 364014 ¹⁾ (RN-001) 374006 ¹⁾ ▼ (RN-001) | | | | 343191 ²⁾ (SP-001) 353013 ²⁾ (SP-001) | | |
| | | 915401 | SM1701 ▼ SM1700 | | | | | | |
| | | 633276 | 333712 324025 | | | | | | |
| | | 915401 | SM1701 ▼ SM1700 | | | 910087 | SM9700 | | |
| (2WD) Golf GTI Exc. 16V, G60 Jetta GTi, GT 16V | 1.90 - 92 1.90 - 92 | 633276 | 333712 324025 | | | | 343191 ²⁾ (SP-001) 353013 ²⁾ (SP-001) | | |
| | | 915401 | SM1701 ▼ SM1700 | | | 910087 | SM9700 | | |
| (2WD) Golf GTI 16V | 2.86 - 12.89 | | 364014 ¹⁾ (RN-001) 374006 ¹⁾ ▼ (RN-001) | | | 443235 ²⁾ ▼ (SP-001) | 343258 ²⁾ (SP-001) 353013 ²⁾ (SP-001) | | |
| | | 915401 | SM1701 ▼ SM1700 | | | | | | |
| | | 633276 | 333712 324025 | | | | | | |
| | | 915401 | SM1701 ▼ SM1700 | | | 910087 | SM9700 | | |
| 1) | 2) | | (OE) (SP-001) | | | | | | |



| MODEL FAHRZEUG MODELE | YEAR JAHR ANNEE | FRONT/VORNE/AVANT | | | | REAR/HINTEN/ARRIERE | | | |
|-----------------------------|-----------------------|-----------------------------|-----------------------------|--------------------------------|--|-----------------------------|-----------------------------|--------------------------------|--|
| | | PREMIUM Twin-tube Oil | EXCEL-G Twin-tube Gas | GAS-A-JUST Mono-tube Gas | | PREMIUM Twin-tube Oil | EXCEL-G Twin-tube Gas | GAS-A-JUST Mono-tube Gas | |

Volkswagen (D)

Golf II, Jetta II Exc.

| | | | | | | | | | |
|---|------------------------------|---|--|--|--|---|--|--|--|
| (2WD) Golf GTI 16V | 1.90 - 92 | 633276 | 333712 324025 | | | 443235 ²⁾ ▼ (SP-001) | 343258 ²⁾ (SP-001) 353013 ²⁾ (SP-001) | | |
| (2WD) Golf 1.8 GTi G60 | 10.89 - 7.91 | 634810 | 334810 324025 | | | 443235 ²⁾ ▼ (SP-001) | 343258 ²⁾ (SP-001) 353013 ²⁾ (SP-001) | | |
| (4WD) Golf Syncro Exc. Rally, Country Jetta Syncro | 2.86 - 12.89 8.87 - 12.89 | 664014 ¹⁾ (RN-001) | 364014 ¹⁾ (RN-001) 374006 ¹⁾ ▼ (RN-001) | | | 443236 ²⁾ ▼ (SP-001) | 343274 ²⁾ (SP-001) | | |
| (4WD) Golf Syncro Exc. Rally, Country Jetta Syncro | 1.90 - 92 | 633276 | 333712 324025 | | | 443236 ²⁾ ▼ (SP-001) | 343274 ²⁾ (SP-001) | | |

1) 2) **OE** **(SP-001)**

Golf III, Vento , Jetta III Exc.

| | | | | | | | | | |
|---|----------------|--------|----------------------|--|--|---|--|--|--|
| (2WD) Golf, Vento 1.4 i, 1.6 i, 1.8 i 1.9 Diesel, 1.9 Turbo Diesel, 1.9 TDI Incl. GT | (1H) 9.91 - 98 | 633276 | 333712 324025 | | | 443800 ¹⁾ (SP-001) | 343191 ¹⁾ (SP-001) 353013 ¹⁾ (SP-001) | | |
|---|----------------|--------|----------------------|--|--|---|--|--|--|

915401²⁾ SM1701▼
 910088 SM1700³⁾
 SM1704³⁾



| MODEL FAHRZEUG MODELE | YEAR JAHR ANNEE | FRONT/VORNE/AVANT | | | REAR/HINTEN/ARRIERE |
|--|-----------------------|-----------------------------|-----------------------------|--------------------------------|--|
| | | PREMIUM Twin-tube Oil | EXCEL-G Twin-tube Gas | GAS-A-JUST Mono-tube Gas | |
| Volkswagen (D) | | | | | |
| Golf III, Vento , Jetta III Exc. | | | | | |
| (2WD) Golf, Vento 2.0 GTI, 2.0 16V GTI, 2.8 VR6 2.8V, 1.9 SDI 2.0 8V | (1H) | 9.91 - 98 | 634810 | 334810 324025 | 343258 ¹⁾ (SP-001) 353013 ¹⁾ (SP-001) |
| (4WD) Golf Syncro, 1.8 Exc. Country | (1H) | 1.93 - 98 | 633276 | 333712 324025 | |
| (4WD) Golf Vento Syncro 2.0, 2.9 VR 6, 1.9 TDI Exc. Country | (1H) | 10.94 - 98 | 634810 | 334810 324025 | |

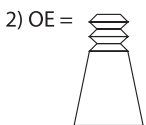
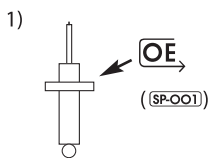

3)

| Model | Year | KYB | |
|--|------------------------------|-------------------|-------------------|
| Golf III | 1.4 / 1.6 | | |
| | 1.8 | AAM | 9.91- 8.94 SM1700 |
| | | ABS | 8.94- 98 SM1704 |
| | | | 9.91- 8.94 SM1700 |
| | | 8.94- 98 SM1704 | |
| | | ADZ | 9.91- 8.94 SM1700 |
| | | ACC | 8.94- 6.95 SM1704 |
| | 12.94- 98 SM1704 | | |
| | 1.9 D / 1.9 TD / 2.0 / 2.8 | | 9.91- 8.94 SM1700 |
| | 1.9 TDI | | 8.94- 98 SM1704 |
| 6.93- 8.94 SM1700 | | | |
| 7.95- 98 SM1704 | | | |
| 1.9 SDi / 2.0 GL / 2.0 GTI 16V / 2.8 VR6 | | 1.92- 9.97 SM1704 | |
| Vento | 1.4 / 1.6 | | 9.91- 8.94 SM1700 |
| | 1.6 | | 9.91- 8.94 SM1700 |
| | 1.4 / 1.6 | | 8.94- 98 SM1704 |
| | 1.8 | AAM | 9.91- 8.94 SM1700 |
| | | AAM | 9.91- 8.94 SM1700 |
| | 1.8 | ABS | 9.91- 8.94 SM1704 |
| | 1.8 | | 8.94- 98 SM1704 |
| | 1.9 SDI | | 7.95- 98 SM1704 |
| | 1.9 TD / 1.9 TDI / 2.0 / 2.8 | | 9.91- 8.94 SM1700 |
| | 8.94- 98 SM1704 | | |

| Model | Year | KYB | |
|------------------|----------------------------|-------------------|-------------------|
| Golf III Variant | 1.4 / 1.6 | | |
| | 1.8 | AAM | 9.91- 8.94 SM1700 |
| | | ABS | 8.94- 98 SM1704 |
| | | | 9.91- 8.94 SM1700 |
| | | 8.94- 6.95 SM1704 | |
| | | ADZ | 10.94- 98 SM1704 |
| | | ACC | 12.94- 98 SM1704 |
| | 1.9 D / 1.9 TD / 2.0 / 2.8 | | 9.91- 8.94 SM1700 |
| | 1.9 TDI | | 8.94- 98 SM1704 |
| | 6.93- 8.94 SM1700 | | |
| 8.94- 98 SM1704 | | | |

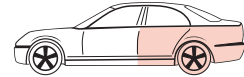
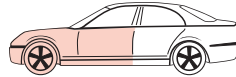

| MODEL FAHRZEUG MODELE | YEAR JAHR ANNEE | FRONT/VORNE/AVANT | | | REAR/HINTEN/ARRIERE | | |
|-----------------------------|-----------------------|-----------------------------|-----------------------------|--------------------------------|-----------------------------|-----------------------------|--------------------------------|
| | | PREMIUM Twin-tube Oil | EXCEL-G Twin-tube Gas | GAS-A-JUST Mono-tube Gas | PREMIUM Twin-tube Oil | EXCEL-G Twin-tube Gas | GAS-A-JUST Mono-tube Gas |

Volkswagen (D)

Golf III Variant

| | | | | | | | | |
|--|------|-----------|---|-------------------------|--|--------|------------------------|--|
| 1.4 i, 1.6 i, 1.8 i 1.9 D, 1.9 TD, 1.9 TDI Exc. Syncro | (1H) | 9.93 - 98 | 633276 | 333712 <u>324025</u> | | 441802 | 341803 ▼ 913145 | |
| | | | 915401 ¹⁾ SM1701 ▼ 910088 SM1700 ²⁾ SM1704 ²⁾ | | | 913145 | | |
| 2.0, 1.9 SDI, 2.9 VR6 Exc. Syncro | (1H) | 9.93 - 98 | 634810 | 334810 <u>324025</u> | | 441802 | 341803 ▼ 913145 | |
| | | | 910088 SM1701 ▼ SM1700 ²⁾ SM1704 ²⁾ | | | 913145 | | |

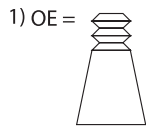

2)

| Model | | Year | KYB | |
|--|----------------------------|------------|------------|--------|
| Golf III | 1.4 / 1.6 | 9.91- 8.94 | SM1700 | |
| | | 8.94- 98 | SM1704 | |
| | 1.8 | AAM | 9.91- 8.94 | SM1700 |
| | | | 8.94- 98 | SM1704 |
| | | ABS | 9.91- 8.94 | SM1700 |
| | | | 8.94- 6.95 | SM1704 |
| | ADZ | 10.94- 98 | SM1704 | |
| | | ACC | 12.94- 98 | SM1704 |
| | 1.9 D / 1.9 TD / 2.0 / 2.8 | | 9.91- 8.94 | SM1700 |
| | | | 8.94- 98 | SM1704 |
| 1.9 TDI | | 6.93- 8.94 | SM1700 | |
| | | 7.95- 98 | SM1704 | |
| 1.9 SDI / 2.0 GL / 2.0 GTI 16V / 2.8 VR6 | | 1.92- 9.97 | SM1704 | |
| Vento | 1.4 / 1.6 | 9.91- 8.94 | SM1700 | |
| | | 9.91- 8.94 | SM1700 | |
| | 1.6 | | 9.91- 8.94 | SM1700 |
| | | | 8.94- 98 | SM1704 |
| | 1.8 | AAM | 9.91- 8.94 | SM1700 |
| | | | 9.91- 8.94 | SM1700 |
| | 1.8 | ABS | 9.91- 8.94 | SM1704 |
| | | | 8.94- 98 | SM1704 |
| | 1.8 | | 8.94- 98 | SM1704 |
| | 1.9 SDI | | 7.95- 98 | SM1704 |
| 1.9 TD / 1.9 TDI / 2.0 / 2.8 | | 9.91- 8.94 | SM1700 | |
| | | 8.94- 98 | SM1704 | |

| Model | | Year | KYB | |
|------------------|----------------------------|------------|------------|--------|
| Golf III Variant | 1.4 / 1.6 | 9.91- 8.94 | SM1700 | |
| | | 8.94- 98 | SM1704 | |
| | 1.8 | AAM | 9.91- 8.94 | SM1700 |
| | | | 8.94- 98 | SM1704 |
| | | ABS | 9.91- 8.94 | SM1700 |
| | | | 8.94- 6.95 | SM1704 |
| | ADZ | 10.94- 98 | SM1704 | |
| | | ACC | 12.94- 98 | SM1704 |
| | 1.9 D / 1.9 TD / 2.0 / 2.8 | | 9.91- 8.94 | SM1700 |
| | | | 8.94- 98 | SM1704 |
| 1.9 TDI | | 6.93- 8.94 | SM1700 | |
| | | 8.94- 98 | SM1704 | |



| MODEL FAHRZEUG MODELE | YEAR JAHR ANNEE | FRONT/VORNE/AVANT | | | | REAR/HINTEN/ARRIERE | | | |
|---|-----------------------|-----------------------------|-----------------------------|--------------------------------|--|-----------------------------|-----------------------------|--------------------------------|--|
| | | PREMIUM Twin-tube Oil | EXCEL-G Twin-tube Gas | GAS-A-JUST Mono-tube Gas | | PREMIUM Twin-tube Oil | EXCEL-G Twin-tube Gas | GAS-A-JUST Mono-tube Gas | |
| Volkswagen (D) | | | | | | | | | |
| Golf IV | | | | | | | | | |
| (2WD) 1.4, 1.6, 1.6 FSI Exc. Sport sus., | (1J1) | 9.97 - 10.03 | 633713 | 333713 <u>324016</u> | | | 343348 | 553206 <u>243037</u> | |
| 915415 | | | 915400 | | | | | | |
| (2WD) 1.8, 1.8 Turbo, 2.0, 2.3, 1.9 SDI, 1.9 TDI Exc. Sport sus., | (1J1) | 9.97 - 10.03 | 634812 | 334812 <u>324016</u> | | | 343348 | 553206 <u>243037</u> | |
| 915415 | | | 915400 | | | | | | |
| (2WD) + Sport sus. | (1J1) | 9.97 - 10.03 | | 334812 <u>324016</u> | | | | 553206 <u>243037</u> | |
| 915415 | | | 915400 | | | | | | |
| (2WD) + | (1J1) | 9.97 - 6.05 | 634812 | 334812 <u>324016</u> | | | | 553206 <u>243037</u> | |
| 915415 | | | 915400 | | | | | | |
| (4WD) 1.8, 2.3, 1.9 TDI → 1J-X-800 000 Exc. Sport sus., , 2.8 V6 | (1J1) | 9.97 - 5.99 | 634812 | 334812 <u>324016</u> | | | 343310 | 553243 | |
| 915415 | | | 915400 | | | | | | |
| (4WD) → 1J-X-800 000 + Sport sus. Exc. 2.8 V6, 3.2 R32 | (1J1) | 9.97 - 5.99 | | 334812 <u>324016</u> | | | 343310 | 553243 | |
| 915415 | | | 915400 | | | | | | |
| (4WD) → 1J-X-800 000 Exc. 2.8 V6, 3.2 R32 | (1J1) | 9.97 - 5.99 | 634812 | 334812 <u>324016</u> | | | 344301 | | |
| 915415 | | | 915400 | | | | | | |
| (4WD) 1.8, 2.3, 1.9 TDI, 2.8 V6 1J-X-800 001 → Exc. | (1J1) | 6.99 - 04 | | 334670 | | | 343310 | 553243 | |
| 915415 | | | 915400 | | | | | | |
| (4WD) 1J-X-800 001 → Exc. 3.2 R32 | (1J1) | 6.99 - 04 | | 334670 | | | 344301 | | |
| 915415 | | | 915400 | | | | | | |
| (4WD) 3.2 R32 | (1J1) | 9.02 - 6.05 | | | | | | | |
| | | | | | | | | | |

1) SM9703 : OE p/n = 1J0513353D

2) SM9704 : OE p/n = 1J0513353B



| MODEL FAHRZEUG MODELE | YEAR JAHR ANNEE | FRONT/VORNE/AVANT | | | | REAR/HINTEN/ARRIERE | | | |
|-----------------------------|-----------------------|-----------------------------|-----------------------------|--------------------------------|--|-----------------------------|-----------------------------|--------------------------------|--|
| | | PREMIUM Twin-tube Oil | EXCEL-G Twin-tube Gas | GAS-A-JUST Mono-tube Gas | | PREMIUM Twin-tube Oil | EXCEL-G Twin-tube Gas | GAS-A-JUST Mono-tube Gas | |

Volkswagen (D)

Golf IV Variant

| | | | | | | | | | |
|--|-------|-----------|--------|------------------|--|--|--------|--|--|
| (2WD) 1.4, 1.6 Exc. Sport sus., | (1J5) | 99 - 6.06 | 633713 | 333713 | | | 343298 | 553232▼ | |
| | | | 915415 | SM1708 | | | 915400 | SM9703 ¹⁾ SM9704 ²⁾ | |
| (2WD) 2.0, 2.3, 1.9 SDI, 1.9 TDI Exc. Sport sus., | (1J5) | 99 - 6.06 | 634812 | 334812 | | | 343298 | 553232▼ | |
| | | | 915415 | SM1708 | | | 915400 | SM9703 ¹⁾ SM9704 ²⁾ | |
| (2WD) ALL + Sport sus. | (1J5) | 99 - 6.06 | | 334812 324016 | | | | 553206 243037 | |
| | | | 915415 | SM1708 | | | 915400 | SM9703 ¹⁾ SM9704 ²⁾ | |
| (2WD) ALL + | (1J5) | 99 - 6.06 | 634812 | 334812 | | | | | |
| | | | 915415 | SM1708 | | | 915400 | SM9703 ¹⁾ SM9704 ²⁾ | |
| (4WD) 2.3, 1.9 TDI, 2.8 V6 Exc. | (1J5) | 99 - 6.06 | | 334670 | | | 343310 | 553243 | |
| | | | | SM1708 | | | | | |
| (4WD) ALL + | (1J5) | 99 - 6.06 | | 334670 | | | 344301 | | |
| | | | | SM1708 | | | | | |

1) SM9703 : OE p/n = 1J0513353D

2) SM9704 : OE p/n = 1J0513353B

Golf V

| | | | | | | | | | |
|--|----------------|------------------------------|----------------------|--|--|----------------------|----------------------|--|--|
| (2WD) (4WD) ALL Exc. Sport sus., , GTi, 3.2 | (1K1) | 10.03 - 2.09 | | 334834 ¹⁾ 335808 ²⁾ 324703 ¹⁾ 325700 ²⁾ | | | 344459 | | |
| | | | 910059 ⁴⁾ | SM1714 | | | 915400 ⁷⁾ | SM9707 ⁷⁾ | |
| | | | 910057 ⁵⁾ | | | 910045 ⁸⁾ | SM9708 ⁸⁾ | | |
| | | | 910177 ⁶⁾ | | | | | | |
| (2WD) ALL + | (1K1) | 1.08 - 12.08 | | | | | 349137 ³⁾ | | |
| | | | 910059 ⁴⁾ | SM1714 | | | 915400 ⁷⁾ | SM9707 ⁷⁾ | |
| | | | 910057 ⁵⁾ | | | 910045 ⁸⁾ | SM9708 ⁸⁾ | | |
| | | | 910177 ⁶⁾ | | | | | | |
| 3.2 R32 (4WD) | (1K1) | 11.05 - 11.08 | | | | | | | |
| | | | 910059 | SM1714 | | | | SM9708 ⁸⁾ | |
| 3.2 (2WD) 2.0 GTi | (1K1) (1K1) | 9.05 - 11.08 10.04 - 2.09 | | | | | | | |
| | | | 910059 | SM1714 | | | | SM9707 ⁷⁾ SM9708 ⁸⁾ | |



| MODEL FAHRZEUG MODELE | YEAR JAHR ANNEE | FRONT/VORNE/AVANT | | | | REAR/HINTEN/ARRIERE | | | |
|-----------------------------|-----------------------|-----------------------------|-----------------------------|--------------------------------|--|-----------------------------|-----------------------------|--------------------------------|--|
| | | PREMIUM Twin-tube Oil | EXCEL-G Twin-tube Gas | GAS-A-JUST Mono-tube Gas | | PREMIUM Twin-tube Oil | EXCEL-G Twin-tube Gas | GAS-A-JUST Mono-tube Gas | |

Volkswagen (D)

Golf V Variant

| | | | | | | |
|---|-------|--------|---|--|--|--|
| 2WD 4WD ALL Exc. Sport sus., | (1K5) | 6.07 - | 334834 ¹⁾ 335808 ²⁾ 324703 ¹⁾ 325700 ²⁾ 910059 ⁴⁾ SM1714 910057 ⁵⁾ 910177 ⁶⁾ | 344459 354006 915400 ⁷⁾ SM9707 ⁷⁾ 910045 ⁸⁾ SM9708 ⁸⁾ | | |
| 2WD ALL ⊕ Sport sus. Exc. , 4WD | (1K5) | 6.07 - | 334834 ¹⁾ 324703 ¹⁾ 910059 ⁴⁾ SM1714 910057 ⁵⁾ 910177 ⁶⁾ | 915400 ⁷⁾ SM9707 ⁷⁾ 910045 ⁸⁾ SM9708 ⁸⁾ | | |
| 2WD 4WD ALL ⊕ Exc. Sport sus. | (1K5) | 6.07 - | 910059 ⁴⁾ SM1714 910057 ⁵⁾ 910177 ⁶⁾ | 349137 ³⁾ 915400 ⁷⁾ SM9707 ⁷⁾ 910045 ⁸⁾ SM9708 ⁸⁾ | | |

Golf V Plus

| | | | | | | |
|---|-------|--------|---|--|--|--|
| 2WD ALL ⊕ Sport sus. Exc. | (5M1) | 1.05 - | 334834 ¹⁾ 335808 ²⁾ 324703 ¹⁾ 325700 ²⁾ 910059 ⁴⁾ SM1714 910057 ⁵⁾ 910177 ⁶⁾ | 344459 354006 915400 ⁷⁾ SM9707 ⁷⁾ 910045 ⁸⁾ SM9708 ⁸⁾ | | |
| 2WD ALL ⊕ Exc. Sport sus. | (5M1) | 1.05 - | 910059 ⁴⁾ SM1714 910057 ⁵⁾ 910177 ⁶⁾ | 349137 ³⁾ 915400 ⁷⁾ SM9707 ⁷⁾ 910045 ⁸⁾ SM9708 ⁸⁾ | | |

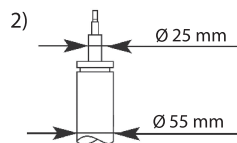
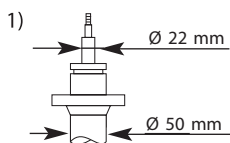

3) ⊕ Normal sus.

4) ⊕ Sport sus.

5) ⊕

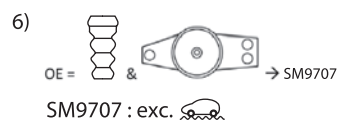



| MODEL FAHRZEUG MODELE | YEAR JAHR ANNEE | FRONT/VORNE/AVANT | | | | REAR/HINTEN/ARRIERE | | | |
|-----------------------------|-----------------------|-----------------------------|-----------------------------|--------------------------------|--|-----------------------------|-----------------------------|--------------------------------|--|
| | | PREMIUM Twin-tube Oil | EXCEL-G Twin-tube Gas | GAS-A-JUST Mono-tube Gas | | PREMIUM Twin-tube Oil | EXCEL-G Twin-tube Gas | GAS-A-JUST Mono-tube Gas | |

Volkswagen (D)

Golf VI

| | | | | | | | | | |
|--|-------|--------------|--|--|--|--|----------------------|----------------------|--|
| [2WD] [4WD] ALL Incl. Sport sus. Exc. | (5K1) | 10.08 - 2.14 | | 334834 ¹⁾ 335808 ²⁾ 324703 ¹⁾ 325700 ²⁾ | | | 344459 354006 | | |
| [2WD] [4WD] ALL + Exc. Sport sus., | (5K1) | 10.08 - 2.14 | | 334834 ¹⁾ 335808 ²⁾ 324703 ¹⁾ 325700 ²⁾ | | | 349137 | | |
| [2WD] [4WD] ALL + | (5K1) | 10.08 - 2.14 | | | | | | SM9709 ⁷⁾ | |

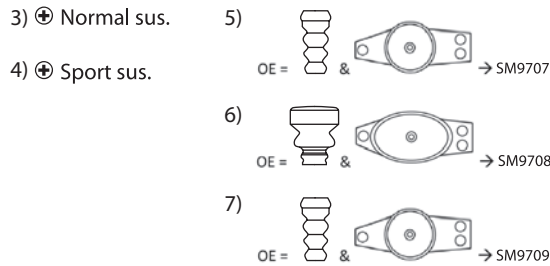
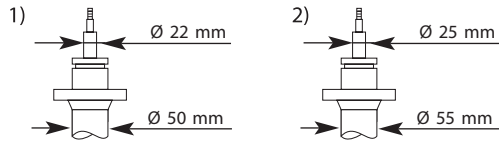

Golf VI Variant

| | | | | | | | | | |
|---|-------|--------------|--|--|--|--|----------------------|--|--|
| [2WD] [4WD] ALL Exc. Sport sus., | (AJ5) | 7.09 - | | 334834 ¹⁾ 335808 ²⁾ 324703 ¹⁾ 325700 ²⁾ | | | 344459 354006 | | |
| [2WD] [4WD] ALL + Exc. Sport sus., | (AJ5) | 7.09 - 12.11 | | | | | 349137 ³⁾ | | |

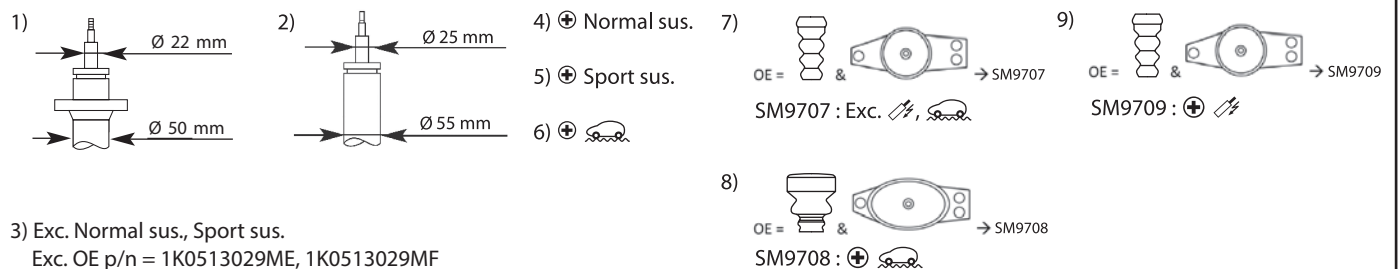
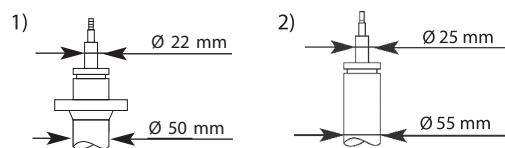



| MODEL FAHRZEUG MODELE | YEAR JAHR ANNEE | FRONT/VORNE/AVANT | | | REAR/HINTEN/ARRIERE | | |
|-----------------------------|-----------------------|-----------------------------|-----------------------------|--------------------------------|-----------------------------|-----------------------------|--------------------------------|
| | | PREMIUM Twin-tube Oil | EXCEL-G Twin-tube Gas | GAS-A-JUST Mono-tube Gas | PREMIUM Twin-tube Oil | EXCEL-G Twin-tube Gas | GAS-A-JUST Mono-tube Gas |

Volkswagen (D)

Golf VII (5G1, BQ1, BE1, BE2)

| | | | | | | | | |
|--|---------|--|--|--------------------------|---|--|--|----------|
| (2WD) ALL (5G1, BQ1, BE1, BE2) Incl. Sport sus., , CNG Exc. , GTD, GTE Hybrid, GTi, e-Golf | 8.12 - | | 3348039 ¹⁾ 3358015 ²⁾ | SM1051 ⁷⁾ | 3430023 ³⁾ 3448024 ⁴⁾ 3448025 ⁵⁾ | 910247 ⁸⁾ 910332 ⁹⁾ | SM9924 ¹⁰⁾ SM9925 ¹⁰⁾ | |
| (2WD) (5G1, BQ1, BE1, BE2) 1.4 GTE Hybrid 2.0 GTD, 2.0 GTi Exc. Sport sus., , Clubsport, TCR | 4.13 - | | 3348039 ¹⁾ 3358015 ²⁾ | SM1051 ⁷⁾ | 3448024 ⁴⁾ | 910247 ⁸⁾ | SM9924 ¹⁰⁾ SM9925 ¹⁰⁾ | |
| (2WD) (5G1, BQ1, BE1, BE2) 2.0 GTi Clubsport ⊕ Sport sus. Exc. , Clubsport S | 2.16 - | | 3358015 ²⁾ | SM1051 ⁷⁾ | 3448024 ⁴⁾ | 910247 ⁸⁾ | SM9924 ¹⁰⁾ SM9925 ¹⁰⁾ | |
| (2WD) (5G1, BQ1, BE1, BE2) e-Golf | 3.14 - | | 3348039 ¹⁾ | SM1051 | 3448024 ⁴⁾ | 910247 ⁸⁾ | SM9925 | |
| (4WD) ALL (5G1, BQ1, BE1, BE2) Incl. Sport sus., Exc. , 2.0 R | 11.12 - | | 3348039 ¹⁾ 3358015 ²⁾ | SM1051 ⁷⁾ | 3448024 ⁴⁾ | 910332 ⁹⁾ | SM9924 ¹⁰⁾ SM9925 ¹⁰⁾ | |
| (4WD) (5G1, BQ1, BE1, BE2) 2.0 R Exc. Sport sus., , 360S | 11.13 - | | | SM1051 ⁷⁾ | 3448024 ⁴⁾ | | SM9924 ¹⁰⁾ SM9925 ¹⁰⁾ | |

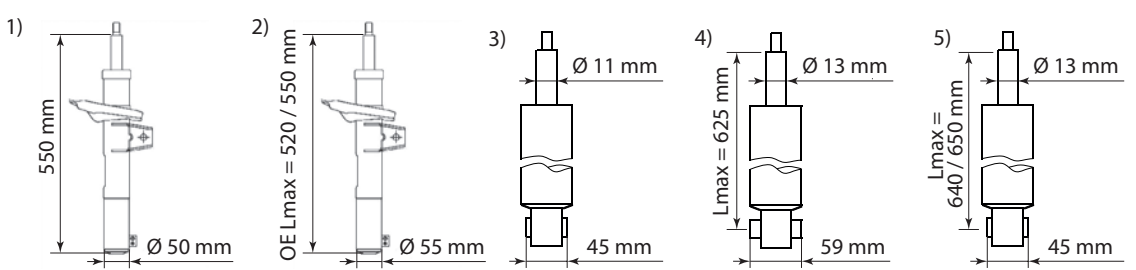

- 6) Exc. 2.0 GTD, 2.0 GTi
- 7) → 1.17
- 8) ⊕ Normal sus.
Exc. Sport sus., , , , 1.4 TGI CNG
- 9) ⊕
Exc. Sport sus., ,
- 10)

| | | |
|--|--|---|
| | | Standard sus. (exc. CNG, incl. Blue Motion), Sport sus. |
| | | Standard sus. (⊕ CNG, exc. Blue Motion) |
| | | (incl. , , GTD, GTE, GTi, R) exc. |



| MODEL FAHRZEUG MODELE | YEAR JAHR ANNEE | FRONT/VORNE/AVANT | | | REAR/HINTEN/ARRIERE | | |
|-----------------------------|-----------------------|-----------------------------|-----------------------------|--------------------------------|-----------------------------|-----------------------------|--------------------------------|
| | | PREMIUM Twin-tube Oil | EXCEL-G Twin-tube Gas | GAS-A-JUST Mono-tube Gas | PREMIUM Twin-tube Oil | EXCEL-G Twin-tube Gas | GAS-A-JUST Mono-tube Gas |

Volkswagen (D)

Golf VII Variant (BA5, BV5)

| | | | | | | | | |
|---|------------|--------|--|--|--|----------------------|---|--|
| [2WD] [ALL] Incl. Sport sus., Exc. , CNG, GTD, Multifuel | (BA5, BV5) | 4.13 - | | 3348039 ¹⁾ 3358015 ²⁾ | | | 3430023 ³⁾ 3448024 ⁴⁾ 3448025 ⁵⁾ | |
| | | | | | | 910332 ⁷⁾ | | |
| [2WD] 1.4 TGI CNG, 1.4 TSi Multifuel 2.0 GTD (135 kW) Incl. Exc. Sport sus., | (BA5, BV5) | 4.13 - | | 3348039 ¹⁾ 3358015 ²⁾ | | | 3448024 ⁴⁾ 3448025 ⁵⁾ | |
| | | | | | | 910332 ⁷⁾ | | |
| [2WD] 2.0 GTD (135 kW) Sport sus. Exc. , | (BA5, BV5) | 1.15 - | | | | | 3448024 ⁴⁾ | |
| | | | | | | | | |
| [4WD] [ALL] Incl. Exc. Sport sus., , 2.0 R | (BA5, BV5) | 4.13 - | | 3348039 ¹⁾ | | | 3448024 ⁴⁾ | |
| | | | | | | 910332 ⁷⁾ | | |
| [4WD] [ALL] Sport sus. Exc. , , 2.0 R | (BA5, BV5) | 4.13 - | | | | | 3448024 ⁴⁾ | |
| | | | | | | | | |

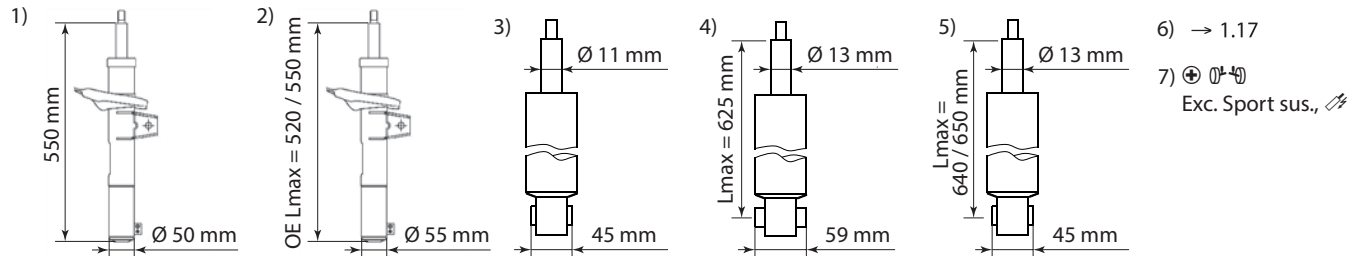

Golf Alltrack VII Variant (BA5, BV5)

| | | | | | | | | |
|----------------------|------------|---------|--|--|--|--|--------|--|
| [ALL] Exc. | (BA5, BV5) | 12.14 - | | | | | 910332 | |
|----------------------|------------|---------|--|--|--|--|--------|--|

Golf Sportsvan (AM1, AN1)

| | | | | | | | | |
|---|------------|--------|--|-----------------------|--|----------------------|---|--|
| [ALL] Incl. Sport sus., Exc. | (AM1, AN1) | 2.14 - | | 3348039 ¹⁾ | | | 3430023 ²⁾ 3448024 ³⁾ 3448025 ⁴⁾ | |
| | | | | | | 910247 ⁵⁾ | | |
| | | | | | | 910332 ⁶⁾ | | |

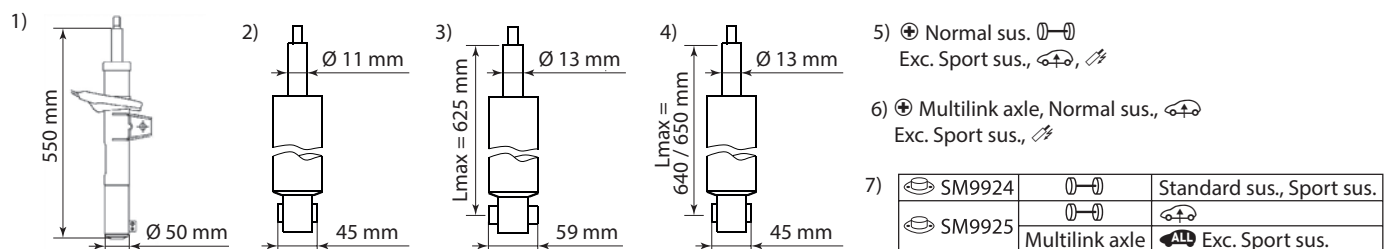

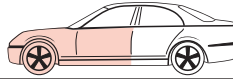

| MODEL FAHRZEUG MODELE | YEAR JAHR ANNEE | FRONT/VORNE/AVANT | | | | REAR/HINTEN/ARRIERE | | | |
|---|-----------------------|-----------------------------|--|--------------------------------|--|----------------------------------|--|--------------------------------|--|
| | | PREMIUM Twin-tube Oil | EXCEL-G Twin-tube Gas | GAS-A-JUST Mono-tube Gas | | PREMIUM Twin-tube Oil | EXCEL-G Twin-tube Gas | GAS-A-JUST Mono-tube Gas | |
| Volkswagen (D) | | | | | | | | | |
| Golf VIII (CD1) , Golf VIII Variant (CG5) | | | | | | | | | |
| (2WD) (4WD) ⊕ Multilink axle Incl. Sport sus., Exc. | (CD1, CG5) | 7.19 - | | | | | | 910332 ¹⁾ | |
| 1) Bumper height : 127 mm | | | | | | | | | |
| Golf Alltrack VIII (CG5) | | | | | | | | | |
| (4WD) ⊕ Multilink axle Incl. Exc. Sport sus., | (CG5) | 11.20 - | | | | | | 910332 ¹⁾ | |
| 1) Bumper height : 127 mm | | | | | | | | | |
| Golf Cabrio | | | | | | | | | |
| Golf I | (155) | 76 - 93 | 663009 | 363001 373012 | | 441018 443172 ²⁾ ▼ | 341007 351007 | | |
| | | | 910088 | | | | | | |
| Golf III Incl. Sport sus. | (1E7) | 9.93 - 2.98 | 634810 | 334810 324025 | | 443800 ¹⁾ | 343191 ¹⁾ 353013 ¹⁾ | | |
| | | | 910088 | | 910087 | | | | |
| Golf IV Incl. Sport sus. | (1E7) | 3.98 - 6.02 | 634810 | 334810 324025 | | 443800 ¹⁾ | 343191 ¹⁾ 353013 ¹⁾ | | |
| | | | 910088 | | 910087 | | | | |
| Golf VI 1.2 TSi, 1.2 TSi 16V 1.4 TSi (kW : 90, 92, 110), 1.6 TDi 2.0 GTI, 2.0 TDi, 2.0 TSi Incl. Sport sus. Exc. | (517) | 3.11 - | | | | | 344459 354006 | | |
| | | | 910059 ³⁾ 910057 ⁴⁾ | | SM9707 ⁵⁾ SM9708 ⁶⁾ | | | | |
| Golf VI 2.0 R, 2.0 TFSi R Incl. Sport sus. Exc. | (517) | 1.13 - | | 335808 | | | 344459 354006 | | |
| | | | 910059 ³⁾ 910057 ⁴⁾ | | SM9707 ⁵⁾ SM9708 ⁶⁾ | | | | |
| <p>1) 2) </p> <p>3) Exc. Sport sus., , 2.0 R 5) & → SM9707 SM9707 : exc. , 2.0 R</p> <p>4) 6) & → SM9708 SM9708 : </p> | | | | | | | | | |



| MODEL FAHRZEUG MODELE | YEAR JAHR ANNEE | FRONT/VORNE/AVANT | | | REAR/HINTEN/ARRIERE | | |
|---|----------------------------|---|--|--|-----------------------------|--|--|
| | | PREMIUM Twin-tube Oil | EXCEL-G Twin-tube Gas | GAS-A-JUST Mono-tube Gas | PREMIUM Twin-tube Oil | EXCEL-G Twin-tube Gas | GAS-A-JUST Mono-tube Gas |
| Volkswagen (D) | | | | | | | |
| Jetta V | | | | | | | |
| Exc. Sport sus., | (1K2) | 8.05 - 10.10 | 334834 ¹⁾ 335808 ²⁾ 324703 ¹⁾ 325700 ²⁾ | SM1714 | 344459 354006 | 915400 ⁶⁾ 910045 ⁷⁾ | SM9707 ⁶⁾ SM9708 ⁷⁾ |
| 1) 2) | | 3) Normal sus. 4) Sport sus. 5) | | 6) OE = & → SM9707 SM9707 : exc. | | 7) OE = & → SM9708 SM9708 : | |
| Jetta VI | | | | | | | |
| Incl. Sport sus. Exc. | (162) | 4.10 - | 334834 ¹⁾ 335808 ²⁾ 324703 ¹⁾ 325700 ²⁾ | SM1714 | 344459 354006 | SM9707 ³⁾ SM9708 ⁴⁾ | |
| Exc. Sport sus. | (162) | 4.10 - | 334834 ¹⁾ 335808 ²⁾ 324703 ¹⁾ 325700 ²⁾ | SM1714 | 349137 | | |
| 1) 2) | | 3) OE = & → SM9707 | | 4) OE = & → SM9708 | | 5) Normal sus. 6) Sport sus. | |
| Käfer / Beetle / Coccinelle / Kever | | | | | | | |
| Type I (swing axle) 1200, 1300, 1300 A, 1500, 1500 A | 8.65 - 79 | 443046 | 343088▼ | | 443045 | 343087▼ | |
| Type I (double articulated axle) 1300, 1300 A, 1500, 1500 A | 5.67 - 79 | 443046 | 343088▼ | | 443047 | 343053 | |
| Type I 1302, S, LS 1303, S | 8.70 - 7.73 9.72 - 7.73 | 663007 | 363012 | | 443047 | 343053 | |

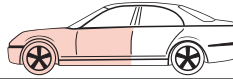

| MODEL FAHRZEUG MODELE | YEAR JAHR ANNEE | FRONT/VORNE/AVANT | | | | REAR/HINTEN/ARRIERE | | | | | | | | | |
|---|-----------------------|-----------------------------|-----------------------------|--------------------------------|--|--|-----------------------------|--------------------------------|--|--|------------|---|--------|-----------------------------------|--------|
| | | PREMIUM Twin-tube Oil | EXCEL-G Twin-tube Gas | GAS-A-JUST Mono-tube Gas | | PREMIUM Twin-tube Oil | EXCEL-G Twin-tube Gas | GAS-A-JUST Mono-tube Gas | | | | | | | |
| Volkswagen (D) | | | | | | | | | | | | | | | |
| Käfer / Beetle / Coccinelle / Kever | | | | | | | | | | | | | | | |
| Type I 1303 | 8.73 - 4.75 | 663008▼ | | | | 443047 | 343053 | | | | | | | | |
| Type III 1600, A, L, TL Incl. | 8.67 - 73 | | | | | 443047 | 343053 | | | | | | | | |
| Lupo | | | | | | | | | | | | | | | |
| 1.0, 1.4, 1.4 TDi, 1.7 SDi Exc. 1.2 TDi 3L (6X) | 98 - 7.05 | 633276 | 333712 324025 | | | | 343309 | | | | | | | | |
| | | 915401 SM1707 | | | | 910280 ¹⁾ SM9939 910281 ¹⁾ | | | | | | | | | |
| 1.6 GTi Exc. 1.2 TDi 3L (6X) | 98 - 7.05 | | | | | | 343309 | | | | | | | | |
| | | 915401 SM1707 | | | | 910280 ¹⁾ SM9939 910281 ¹⁾ | | | | | | | | | |
| 1.2 TDi 3L, 1.4 FSi (6X, 6E) | 01 - | | | | | | 343309 | | | | | | | | |
| | | 915401 SM1707 | | | | 910280 ¹⁾ SM9939 910281 ¹⁾ | | | | | | | | | |
| 1) <table border="1"> <tr> <td></td> <td>KYB</td> </tr> <tr> <td>1.0, 1.2 TDi 3L, 1.4, 1.4 16V (55 kW), 1.4 TDi, 1.7 SDi</td> <td> 910280</td> </tr> <tr> <td>1.4 16V (74 kW), 1.4 FSi, 1.6 GTi</td> <td> 910281</td> </tr> </table> | | | | | | | | | | | KYB | 1.0, 1.2 TDi 3L, 1.4, 1.4 16V (55 kW), 1.4 TDi, 1.7 SDi | 910280 | 1.4 16V (74 kW), 1.4 FSi, 1.6 GTi | 910281 |
| | KYB | | | | | | | | | | | | | | |
| 1.0, 1.2 TDi 3L, 1.4, 1.4 16V (55 kW), 1.4 TDi, 1.7 SDi | 910280 | | | | | | | | | | | | | | |
| 1.4 16V (74 kW), 1.4 FSi, 1.6 GTi | 910281 | | | | | | | | | | | | | | |
| New Beetle (1C, 9C) | | | | | | | | | | | | | | | |
| Exc. RSI (1C, 9C) | 1.98 - 9.10 | | 334812 324016 | | | | 343348 | 553206 243037 | | | | | | | |
| | | 915415 SM1708 | | | | 915400 SM9703 ¹⁾ SM9704 ²⁾ | | | | | | | | | |
| RSI 3.2 4motion (1C9) | 4.00 - 5.01 | | | | | | | | | | | | | | |
| | | 915415 SM1708 | | | | 915400 SM9703 ¹⁾ | | | | | | | | | |
| 1) SM9703 : OE p/n = 1J0513353D 2) SM9704 : OE p/n = 1J0513353B | | | | | | | | | | | | | | | |
| Passat, Santana (- 88) | | | | | | | | | | | | | | | |
| Passat (32) Exc. | 7.73 - 10.80 | 664001 | | | | | | | | | | | | | |
| | | | | | | | | | | | | | | | |
| Passat Variant (33) Exc. | 73 - 2.81 | 664001 | | | | | | | | | | | | | |
| | | | | | | | | | | | | | | | |





| MODEL FAHRZEUG MODELE | YEAR JAHR ANNEE | FRONT/VORNE/AVANT | | | REAR/HINTEN/ARRIERE | | |
|-----------------------------|-----------------------|-----------------------------|-----------------------------|--------------------------------|-----------------------------|-----------------------------|--------------------------------|
| | | PREMIUM Twin-tube Oil | EXCEL-G Twin-tube Gas | GAS-A-JUST Mono-tube Gas | PREMIUM Twin-tube Oil | EXCEL-G Twin-tube Gas | GAS-A-JUST Mono-tube Gas |

Volkswagen (D)

Passat, Santana (- 88)

| | | | | | | | |
|--|--|--------|--------------------------------------|--------|---|--|--|
| Passat (32B) Passat Variant Santana → 32D155757 Exc. | 11.80 - 3.83 3.81 - 83 82 - 3.83 | 665030 | 365500 <u>375008²⁾</u> | 910088 | 443164 ¹⁾ <u>(SP-001)</u> | 915408▼ 910087 | |
| (32B) Passat Passat Variant Santana 32D155758 → Exc. | 4.83 - 3.88 | 665030 | 365500 <u>375008²⁾</u> | 910088 | 443209 ¹⁾ <u>(SP-001)</u> | 343206 ¹⁾ ▼ <u>(SP-001)</u> 915408▼ 910087 | |
| Syncro Exc. | 8.84 - 8.88 | | 365500 <u>375008²⁾</u> | | | 551063 | |
| | (32B) 8.84 - 8.88 | | 365500 <u>375008²⁾</u> | | | 551063 | |

Passat (88 - 96)

| | | | | | | | |
|--|-------------|----------------------|-------------------------|--------|---|---|--|
| (3A2, 351) Variant (3A5, 351) Exc. 2.8 VR6, | 4.88 - 7.91 | 665500 ²⁾ | 365502 ²⁾ | 915401 | 443246 ¹⁾ <u>(SP-001)</u> | 343223 ¹⁾ <u>(SP-001)</u> | |
| | | 634810 | 334810 <u>324025</u> | | | | |
| | | 915401 | | | 915408▼ 910087 | | |
| (3A2, 351) Variant (3A5, 351) → P-026435 Exc. 2.8 VR6, | 8.91 - 92 | 634810 | 334810 <u>324025</u> | 915401 | 443246 ¹⁾ <u>(SP-001)</u> | 343223 ¹⁾ <u>(SP-001)</u> | |
| (3A2, 351) Variant (3A5, 351) P-026436 → Exc. 2.8 VR6, | 92 - 96 | 634811 | 334811 | 910088 | 443246 ¹⁾ <u>(SP-001)</u> | 343223 ¹⁾ <u>(SP-001)</u> | |
| | | 910088 | | | 915408▼ 910087 | | |

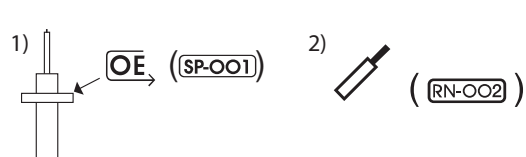



| MODEL FAHRZEUG MODELE | YEAR JAHR ANNEE | FRONT/VORNE/AVANT | | | | REAR/HINTEN/ARRIERE | | | |
|--|--------------------------|-----------------------------|------------------------------------|--|--|----------------------------------|----------------------------------|-------------------------------------|--|
| | | PREMIUM Twin-tube Oil | EXCEL-G Twin-tube Gas | GAS-A-JUST Mono-tube Gas | | PREMIUM Twin-tube Oil | EXCEL-G Twin-tube Gas | GAS-A-JUST Mono-tube Gas | |
| Volkswagen (D) | | | | | | | | | |
| Passat (88 - 96) | | | | | | | | | |
| (2WD) 2.8 VR6 2.8 VR6 Exc. Syncro, , | (3A2, 35I) (3A5, 35I) | 8.91 - 96 | 634811 ☺☺☺☺ 910088 | 334811 | | 443246 ¹⁾ (SP-001) | 343223 ¹⁾ (SP-001) | ☺☺☺☺ 915408▼ ☺☺☺☺ 910087 | |
| Syncro (4WD) 1.8 G60/2.0 1.8 G60/2.0 Exc. | (3A2, 35I) (3A5, 35I) | 9.89 - 7.91 10.90 - 7.91 | 665500 ²⁾ 634810 | 365502 ²⁾ 334810 324025 | | | | 551063 | |
| Syncro (4WD) 1.8 G60/2.0 1.8 G60/2.0 → P-026435 Exc. | (3A2, 35I) (3A5, 35I) | 8.91 - 92 | 634810 | 334810 324025 | | | | 551063 | |
| Syncro (4WD) 1.8 G60/2.0 1.8 G60/2.0 P-026436 → Exc. | (3A2, 35I) (3A5, 35I) | 92 - 96 | 634811 | 334811 | | | | 551063 | |
| Syncro (4WD) 2.8 VR6 2.8 VR6 Exc. , | (3A2, 35I) (3A5, 35I) | 8.91 - 96 | 634811 ☺☺☺☺ 913147 | 334811 | | | | 551063 | |
| Syncro (4WD) 1.8 G60/2.0 1.8 G60/2.0 ⊕ | (3A2, 35I) (3A5, 35I) | 9.89 - 92 | ☺☺☺☺ 913147 | 334810 324025 | | | | | |
| Syncro (4WD) 1.8 G60/2.0 1.8 G60/2.0 ⊕ | (3A2, 35I) (3A5, 35I) | 92 - 96 | ☺☺☺☺ 913147 | 334811 | | | | | |

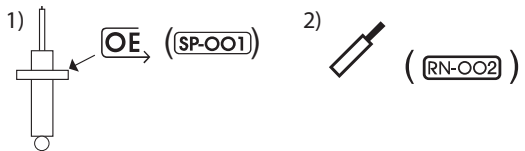



| MODEL FAHRZEUG MODELE | YEAR JAHR ANNEE | FRONT/VORNE/AVANT | | | REAR/HINTEN/ARRIERE | | |
|--|-----------------------|-----------------------------|--|--------------------------------|-----------------------------|-----------------------------|--------------------------------|
| | | PREMIUM Twin-tube Oil | EXCEL-G Twin-tube Gas | GAS-A-JUST Mono-tube Gas | PREMIUM Twin-tube Oil | EXCEL-G Twin-tube Gas | GAS-A-JUST Mono-tube Gas |
| Volkswagen (D) | | | | | | | |
| Passat (3B) (97-05) | | | | | | | |
| (2WD) ALL (3B2) Variant ALL (3B5) → 3B-YE121221 Exc. Sport sus., , 2.5 i V6, 2.8 V6 | 97 - | | 341842 | | | 343281 | 553207 |
| | | 915708 | SM1711 ⁽¹⁾⁽²⁾ ▼ SM5236 ⁽¹⁾⁽²⁾ | | 910003 | SM9706 ⁽¹⁾ | |
| (2WD) ALL (3B2) Variant ALL (3B5) 3B-YE121221 → Exc. Sport sus., , 2.5 i V6, 2.8 V6 | - 10.00 | | 341844 | | | 343281 | 553207 |
| | | 915708 | SM1712 ⁽¹⁾⁽²⁾ ▼ SM5236 ⁽¹⁾⁽²⁾ | | 910003 | SM9706 ⁽¹⁾ | |
| Syncro (4WD) ALL (3B2) Variant ALL (3B5) → 3B-YE121221 Exc. Sport sus., , 2.5 i V6, 2.8 V6 | 97 - | | 341842 | | | | |
| | | 915708 | SM1711 ⁽¹⁾⁽²⁾ ▼ SM5236 ⁽¹⁾⁽²⁾ | | | | |
| Syncro (4WD) ALL (3B2) Variant ALL (3B5) 3B-YE121221 → Exc. Sport sus., , 2.5 i V6, 2.8 V6 | - 10.00 | | 341844 | | | | |
| | | 915708 | SM1712 ⁽¹⁾⁽²⁾ ▼ SM5236 ⁽¹⁾⁽²⁾ | | | | |
| (2WD) ALL (3B2) Variant ALL (3B5) 3B-YE121221 ⊕ Sport sus. Exc. , 2.5 i V6, 2.8 V6 | 97 - | | 341843 | | | | 553207 |
| | | 915708 | SM1711 ⁽¹⁾⁽²⁾ ▼ SM5236 ⁽¹⁾⁽²⁾ | | 910228 | SM9706 ⁽¹⁾ | |
| (2WD) ALL (3B2) Variant ALL (3B5) 3B-YE121221 → ⊕ Sport sus. Exc. , 2.5 i V6, 2.8 V6 | - 10.00 | | 341844 | | | | 553207 |
| | | 915708 | SM1712 ⁽¹⁾⁽²⁾ ▼ SM5236 ⁽¹⁾⁽²⁾ | | 910228 | SM9706 ⁽¹⁾ | |
| Syncro (4WD) ⊕ Sport sus. ALL (3B2) Variant ALL (3B5) → 3B-YE121221 Exc. , 2.5 i V6, 2.8 V6 | 97 - | | 341843 | | | | |
| | | 915708 | SM1711 ⁽¹⁾⁽²⁾ ▼ SM5236 ⁽¹⁾⁽²⁾ | | | | |
| Syncro (4WD) ⊕ Sport sus. ALL (3B2) Variant ALL (3B5) 3B-YE121221 → Exc. , 2.5i V6, 2.8 V6 | - 10.00 | | 341844 | | | | |
| | | 915708 | SM1712 ⁽¹⁾⁽²⁾ ▼ SM5236 ⁽¹⁾⁽²⁾ | | | | |
| (2WD) (4WD) 2.8 V6 (3B2) | 8.96 - 11.00 | | | | | | |
| | | 915708 | SM1711 ⁽¹⁾⁽²⁾ ▼ SM1712 ⁽¹⁾⁽²⁾ ▼ SM5236 ⁽¹⁾⁽²⁾ | | | SM9706 ⁽¹⁾ | |



| MODEL FAHRZEUG MODELE | YEAR JAHR ANNEE | FRONT/VORNE/AVANT | | | | REAR/HINTEN/ARRIERE | | | |
|-----------------------------|-----------------------|-----------------------------|-----------------------------|--------------------------------|--|-----------------------------|-----------------------------|--------------------------------|--|
| | | PREMIUM Twin-tube Oil | EXCEL-G Twin-tube Gas | GAS-A-JUST Mono-tube Gas | | PREMIUM Twin-tube Oil | EXCEL-G Twin-tube Gas | GAS-A-JUST Mono-tube Gas | |

Volkswagen (D)

Passat (3B) (97-05)

| | | | | | | | | | |
|--|----------------|--------------|--------|--------|--|--|--------|-----------------------|--|
| (2WD) (4WD) 2.8 V6 | (3B5) | 8.96 - 11.00 | | 915708 | SM1711 ⁽¹⁾⁽²⁾ ▼ SM1712 ⁽¹⁾⁽²⁾ ▼ SM5236 ⁽¹⁾⁽²⁾ | | | SM9706 ⁽¹⁾ | |
| (2WD) Variant Exc. Sport sus., | (3B3) (3B6) | 11.00 - 2.05 | 341844 | 915708 | SM1712 ⁽¹⁾⁽²⁾ ▼ SM5236 ⁽¹⁾⁽²⁾ SM5380 ⁽¹⁾ | | 343281 | 553207 Exc. | SM9706 ⁽¹⁾ SM5379 ⁽¹⁾ |
| (2WD) Variant ⊕ Sport sus. Exc. | (3B3) (3B6) | 11.00 - 2.05 | 341844 | 915708 | SM1712 ⁽¹⁾⁽²⁾ ▼ SM5236 ⁽¹⁾⁽²⁾ SM5380 ⁽¹⁾ | | | 553207 Exc. | SM9706 ⁽¹⁾ SM5379 ⁽¹⁾ |
| Syncro (4WD) Variant Incl. Sport sus. Exc. , 4.0 W8 | (3B3) (3B6) | 11.00 - 2.05 | 341844 | 915708 | SM1712 ⁽¹⁾⁽²⁾ ▼ SM5236 ⁽¹⁾⁽²⁾ SM5380 ⁽¹⁾ | | | | |
| (2WD) ⊕ 3B-YE121222 → Exc. Syncro 4motion (4WD) | | - 05 | 341301 | 915708 | | | 345027 | | |
| Syncro (4WD) ⊕ 3B-YE121222 → | | - 05 | 341301 | 915708 | | | | | |

1)

| | | 3B2, 3B3 | | | | 3B5 | | | | 3B6 | |
|--|-------|----------|---------------------|--------|-----------------|----------|---------------------|--------|--|--------|--|
| | | KYB | | KYB | | KYB | | KYB | | KYB | |
| | (2WD) | SM1711 ▼ | 97 → 3B-YE018431 | SM5380 | 3B-1-3000 001 → | SM1711 ▼ | 97 → 3B-YE018431 | SM5380 | | | |
| | (4WD) | SM1712 ▼ | 3B-YE018432 → 10.00 | | | SM1712 ▼ | 3B-YE018432 → 10.00 | | | SM5380 | |
| | | SM5236 | 97 → 3B-1-3000 000 | | | SM5236 | | | | | |
| | (2WD) | SM9706 | 97 → 3B-1-3000 000 | SM5379 | 3B-1-3000 001 → | SM9706 | | SM5379 | | | |
| | (4WD) | ∅ | | | | ∅ | | | | | |

2)

| KYB | |
|----------|--|
| SM1711 ▼ | See pictures in section suspension mounting type numerical listing |
| SM1712 ▼ | |
| SM5236 | |

Passat (3C2, 3C5) (05-)

| | | | | | | | | | |
|--|------------|--------|--|------------------|--------|--|--------|------------------|--|
| (2WD) (4WD) Exc. Sport sus., , 3.6, , | (3C2, 3C5) | 3.05 - | | 335808 325700 | | | | 344459 354006 | |
| | | | | 910059 | SM1714 | | 910056 | SM9709 | |
| 3.6 R36 4motion (4WD) | (3C2, 3C5) | 3.05 - | | | SM1714 | | | SM9709 | |



| MODEL FAHRZEUG MODELE | YEAR JAHR ANNEE | FRONT/VORNE/AVANT | | | | REAR/HINTEN/ARRIERE | | | |
|-----------------------------|-----------------------|-----------------------------|-----------------------------|--------------------------------|--|-----------------------------|-----------------------------|--------------------------------|--|
| | | PREMIUM Twin-tube Oil | EXCEL-G Twin-tube Gas | GAS-A-JUST Mono-tube Gas | | PREMIUM Twin-tube Oil | EXCEL-G Twin-tube Gas | GAS-A-JUST Mono-tube Gas | |

Volkswagen (D)

Passat (362, 365) (10-)

| | | | | | | | | | |
|--|------------------|--|----------------------|--------|--|--------|-----------------------|--------|--|
| (2WD) (4WD) (362) (2WD) (365) Incl. , Sport sus., Blue-Motion Exc. , , | 8.10 - | | 335808 | | | | 344459 | | |
| | | | 325700 | | | 354006 | | | |
| | | | 910059 ¹⁾ | SM1714 | | | 910056 | SM9709 | |
| (4WD) (365) Incl. , Sport sus. Exc. , , | 8.10 - | | 335808 | | | | 344459 | | |
| | | | 325700 | | | 354006 | | | |
| | | | 910059 ¹⁾ | SM1714 | | | 910056 | SM9709 | |
| (362, 365) 1.8 TFSi (112 kW) 2.0 TDi (125 kW) Incl. , Sport sus., Blue-Motion Exc. | 2.11 - 8.10 - | | 335808 | | | | | | |
| | | | 325700 | | | | | | |
| | | | 910059 ¹⁾ | SM1714 | | | | | |
| Alltrack (365) Exc. | 1.12 - | | 335808 | | | | 3440042 ²⁾ | | |
| | | | 325700 | | | | | | |
| | | | | | | | 910056 | SM9709 | |

1) Normal sus. 2) 3.12 →

Passat CC

| | | | | | | | | | |
|-------------------|---------|--|--------|--------|--|--------|--------|--------|--|
| (357) Exc. | 5.08 - | | 335808 | | | | 344459 | | |
| | | | 325700 | | | 354006 | | | |
| | | | 910059 | SM1714 | | | 910056 | SM9709 | |
| (358) Exc. | 11.11 - | | 335808 | | | | 344459 | | |
| | | | 325700 | | | 354006 | | | |
| | | | 910059 | SM1714 | | | 910056 | SM9709 | |

Passat (3G2, CB2) , Passat Variant (3G5, CB5)

| | | | | | | | | | |
|--|--------|--|---------|--|--|-----------------------|-----------------------|--------|--|
| (3G_, CB_) 8.14 - Exc. Sport sus., , , , | 8.14 - | | 3358015 | | | | 3448023 ¹⁾ | | |
| | | | | | | 3448024 ¹⁾ | | | |
| | | | | | | | 910332 ²⁾ | SM9925 | |
| (3G_, CB_) 8.14 - Sport sus., , Exc. , | 8.14 - | | 3358015 | | | | 3448024 ¹⁾ | | |
| | | | | | | | | | |
| | | | | | | | 910332 ²⁾ | SM9925 | |

1) 2) Bumper height : 127 mm, Normal sus.,
 Exc. Sport sus., ,

| KYB | A |
|---------|--------|
| 3448023 | 415 mm |
| 3448024 | 400 mm |

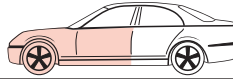

| MODEL FAHRZEUG MODELE | YEAR JAHR ANNEE | FRONT/VORNE/AVANT | | | | REAR/HINTEN/ARRIERE | | | | | | | | | |
|--|-----------------------|-----------------------------|---|--------------------------------|--|------------------------------|---|--------------------------------|--|-----|---|---------|--------|---------|--------|
| | | PREMIUM Twin-tube Oil | EXCEL-G Twin-tube Gas | GAS-A-JUST Mono-tube Gas | | PREMIUM Twin-tube Oil | EXCEL-G Twin-tube Gas | GAS-A-JUST Mono-tube Gas | | | | | | | |
| Volkswagen (D) | | | | | | | | | | | | | | | |
| Passat Alltrack (3G5, CB5) | | | | | | | | | | | | | | | |
| Exc. Sport sus., | (3G5, CB5) | 5.15 - | | 3358015 | | | 3448023 ¹⁾ 3448024 ¹⁾ | | | | | | | | |
| | | | | SM1051 | | 910332 SM9925 ²⁾ | | | | | | | | | |
| + Sport sus. Exc. | (3G5, CB5) | 5.15 - | | 3358015 | | | 3448024 ¹⁾ | | | | | | | | |
| | | | | SM1051 | | 910332 SM9925 ²⁾ | | | | | | | | | |
| 1) 2) Incl. <table border="1" style="margin-left: 20px;"> <thead> <tr> <th>KYB</th> <th>A</th> </tr> </thead> <tbody> <tr> <td>3448023</td> <td>415 mm</td> </tr> <tr> <td>3448024</td> <td>400 mm</td> </tr> </tbody> </table> | | | | | | | | | | KYB | A | 3448023 | 415 mm | 3448024 | 400 mm |
| KYB | A | | | | | | | | | | | | | | |
| 3448023 | 415 mm | | | | | | | | | | | | | | |
| 3448024 | 400 mm | | | | | | | | | | | | | | |
| Polo, Derby | | | | | | | | | | | | | | | |
| Polo (Exc. G40) Derby | | 75 - 94 7.76 - 86 | 663035 | | | | 441019 341023▼ 351004▼ | | | | | | | | |
| | | | 915404 SM1703 | | | 915412 ¹⁾ | | | | | | | | | |
| 1.0, 1.05, 1.3, 1.4, 1.6, 1.7 SDI, 1.9 D 1.9 SDI | (6N1) | 9.94 - 10.99 | 633276 | 333712 324025 | | | 443801 ⁴⁾ 343274 ⁴⁾ 353021 ⁴⁾ | | | | | | | | |
| | | | 915401 ²⁾ SM1707 910084 ³⁾ | | | 915418 SM9700 | | | | | | | | | |
| 1.0, 1.4, 1.4 TDI, 1.7 SDI, 1.9 SDI 1.9 D | (6N2) | 10.99 - 9.01 | 633276 | 333712 324025 | | | 443801 ⁴⁾ 343274 ⁴⁾ 353021 ⁴⁾ | | | | | | | | |
| | | | 910084 SM1713 | | | 915418 SM9700 | | | | | | | | | |
| 1.6 GTi | (6N2) | 10.99 - 9.01 | | | | | 443801 ⁴⁾ 343274 ⁴⁾ 353021 ⁴⁾ | | | | | | | | |
| | | | 910084 SM1713 | | | 915418 SM9700 | | | | | | | | | |
| Classic 1.4, 1.6, 1.7 SDI | (6KV2) | 95 - 9.01 | 633276 | 333712 324025 | | | 443801 ⁴⁾ 343274 ⁴⁾ 353021 ⁴⁾ | | | | | | | | |
| | | | 915401 ²⁾ SM1707 910084 ³⁾ | | | 915419 SM9700 | | | | | | | | | |
| Classic 1.8, 1.9 SDI, 1.9 TDI | (6KV2) | 95 - 9.01 | 634810 | 334810 324025 | | | 443801 ⁴⁾ 343274 ⁴⁾ 353021 ⁴⁾ | | | | | | | | |
| | | | 915401 ²⁾ SM1707 910084 ³⁾ | | | 915419 SM9700 | | | | | | | | | |
| 1) 915412 = not for 441019, 341023, 351004 4) () 2) → 6KX610000 3) 6KX610000 → | | | | | | | | | | | | | | | |



Volkswagen

| MODEL FAHRZEUG MODELE | YEAR JAHR ANNEE | FRONT/VORNE/AVANT | | | REAR/HINTEN/ARRIERE | | |
|-----------------------------|-----------------------|-----------------------------|-----------------------------|--------------------------------|-----------------------------|-----------------------------|--------------------------------|
| | | PREMIUM Twin-tube Oil | EXCEL-G Twin-tube Gas | GAS-A-JUST Mono-tube Gas | PREMIUM Twin-tube Oil | EXCEL-G Twin-tube Gas | GAS-A-JUST Mono-tube Gas |

Volkswagen (D)

Polo , Polo Variant

| | | | | | | | | | | | |
|-----------------------------------|-------------|-----------|-----------------------------|------------------|--|----------------------|----------------------|--|--|--|--|
| 1.4, 1.6, 1.8 1.7 SDI, 1.9 SDI | (6KV5, 6NF) | 97 - 9.01 | 633276 | 333712 324025 | | 443296 ¹⁾ | 343297 ¹⁾ | | | | |
| | | | 910084 ²⁾ SM1713 | | | 915419 | SM9700 | | | | |
| 1.9 D, 1.9 TDI | (6KV5, 6NF) | 97 - 9.01 | 634810 | 334810 324025 | | 443296 ¹⁾ | 343297 ¹⁾ | | | | |
| | | | 910084 ²⁾ SM1704 | | | 915419 | SM9700 | | | | |

1) OE (SG-701)

2) Exc. Polo

Polo (9N, 9A4)

| | | | | | | | | | | | |
|---|------|---------------|----------------|------------------|--|--------|------------------|--|--|--|--|
| (9N, 9A4) Exc. Sport sus., , Cup Edition | | 10.01 - 11.09 | | 334835 324702 | | | 343328 353025 | | | | |
| | | | 910084 SM1713 | | | 915400 | SM9704 | | | | |
| | (9N) | 10.01 - 11.09 | | | | | 343348 | | | | |
| | | | SM1713 | | | 915400 | SM9704 | | | | |

Polo V

| | | | | | | | | | | | |
|--|------------|--------|----------------|--------|--|--------|------------------|--------|--|--|--|
| (6R1, 6C1) Exc. Sport sus., , , Exc. GTi, WRC, Cross Polo | | 3.09 - | | 339763 | | | 343328 353025 | 552700 | | | |
| | | | 910154 SM1708 | | | 915400 | SM9704 | | | | |
| 1.0, 1.0 TSi, 1.2 TSi (81 kW) 1.4 TSi (110 kW), 1.6 1.4 TDi Sport sus. Exc. GTi, WRC, Cross Polo, | (6R1, 6C1) | 1.10 - | | 339741 | | | | | | | |
| | | | 910154 SM1708 | | | 915400 | SM9704 | | | | |
| 1.2, 1.2 TSi (66 kW, 77 kW) 1.4, 1.4 TSi (103 kW) 1.4 BiFuel, 1.6 BiFuel 1.2 TDi, 1.6 TDi Sport sus. Exc. GTi, WRC, Cross Polo, | (6R1, 6C1) | 3.09 - | | 339741 | | | | 552700 | | | |
| | | | 910154 SM1708 | | | 915400 | SM9704 | | | | |
| 1.0, 1.0 TSi, 1.2 TSi (kW : 66, 81) 1.4 TSi (110 kW), 1.6 1.4 TDi Exc. GTi, WRC, Cross Polo, | (6R1, 6C1) | 1.10 - | | 339763 | | | 343348 | | | | |
| | | | 910154 SM1708 | | | 915400 | SM9704 | | | | |
| 1.2, 1.2 TSi (77 kW), 1.4 1.4 TSi (103 kW), 1.4 BiFuel, 1.6 BiFuel 1.2 TDi, 1.6 TDi Exc. GTi, WRC, Cross Polo, | (6R1, 6C1) | 3.09 - | | | | | 343348 | | | | |
| | | | 910154 SM1708 | | | 915400 | SM9704 | | | | |



| MODEL FAHRZEUG MODELE | YEAR JAHR ANNEE | FRONT/VORNE/AVANT | | | | REAR/HINTEN/ARRIERE | | | |
|--|-----------------------|-----------------------------|-----------------------------|--------------------------------|--|-----------------------------|-----------------------------|--------------------------------|--|
| | | PREMIUM Twin-tube Oil | EXCEL-G Twin-tube Gas | GAS-A-JUST Mono-tube Gas | | PREMIUM Twin-tube Oil | EXCEL-G Twin-tube Gas | GAS-A-JUST Mono-tube Gas | |
| Volkswagen (D) | | | | | | | | | |
| Polo V | | | | | | | | | |
| 1.0, 1.0TSi, 1.2 TSi (kW : 66, 81) (6R1, 6C1) 1.4 TSi (110 kW), 1.6 1.4 TDi ⊕ Exc. GTi, WRC, Cross Polo, | 1.10 - | | 339763 | | | | | | |
| | | 910154 | SM1708 | | | 915400 | SM9704 | | |
| 1.4 GTi, 1.8 GTi, 2.0 R WRC (6R1, 6C1) Incl. Sport sus. Exc. GTi 230, Cross Polo, | 5.10 - | | 3348020 | | | | | | |
| | | 910154 | SM1708 | | | 915400 | SM9704 | | |
| Cross Polo (6R1, 6C1) Incl. , Exc. Sport sus., | 3.09 - | | 339763 | | | | 343348 | | |
| | | 910154 | SM1708 | | | 915400 | SM9704 | | |
| Cross Polo (6R1, 6C1) ⊕ Sport sus. Exc. | 3.09 - | | 339741 | | | | 343348 | | |
| | | 910154 | SM1708 | | | 915400 | SM9704 | | |
| Polo V | | | | | | | | | |
| 1.4 TSi, 1.6 (602, 604, 612, 614) Incl. , Exc. | 5.10 - | | 339763 | | | | 344357 | | |
| | | | SM1708 | | | | SM9704 | | |
| 1.4 TSi, 1.6 (602, 604, 612, 614) ⊕ Sport sus. Exc. | 5.10 - | | 339741 | | | | 344357 | | |
| | | | SM1708 | | | | SM9704 | | |
| Polo VI | | | | | | | | | |
| 1.0, 1.0 MPI, 1.0 TGI (AW1, BZ1) 1.0 TSI, 1.5 TSI, 1.6 TDI Incl. Sport sus. Exc. Comfortline, Flex, , | 6.17 - | | 3348074 | | | | | | |
| | | | SM1051 | | | | | | |
| 2.0 GTi (147 kW) (AW1, BZ1) ⊕ Sport sus. Exc. | 11.17 - 3.21 | | 3348074 | | | | | | |
| | | | SM1051 | | | | | | |
| 1.0, 1.0 MPI, 1.0 TGI (AW1, BZ1) 1.0 TSI, 1.5 TSI, 1.6 TDI ⊕ Exc. Comfortline, Flex, | 6.17 - | | 3348074 | | | | 3430074 | | |
| | | | SM1051 | | | | | | |



Volkswagen

| MODEL FAHRZEUG MODELE | YEAR JAHR ANNEE | FRONT/VORNE/AVANT | | | | REAR/HINTEN/ARRIERE | | | |
|-----------------------------|-----------------------|-----------------------------|-----------------------------|--------------------------------|--|-----------------------------|-----------------------------|--------------------------------|--|
| | | PREMIUM Twin-tube Oil | EXCEL-G Twin-tube Gas | GAS-A-JUST Mono-tube Gas | | PREMIUM Twin-tube Oil | EXCEL-G Twin-tube Gas | GAS-A-JUST Mono-tube Gas | |

Volkswagen (D)

Scirocco

| | | | | | | | | | |
|--|--------------|------------|--|--------|--|----------------------------------|----------------------|--|--|
| (53, 53B) Exc. GTI, GLI, GTX | 74 - 92 | 663009 | 363001 373012 | | | 441018 443172 ²⁾ ▼ | 341007 351007 | | |
| GTI, GLI, GTX Exc. 16V | 74 - 92 | | 363001 373012 | | | | 341007 351007 | | |
| 1.4 TSi, 2.0 TSi, 2.0 TDi Exc. Sport sus. | (137) 5.08 - | | 335808 ¹⁾ 325700 ¹⁾ | | | | 344459 354006 | | |
| 2.0 R | (137) 5.08 - | | | SM1714 | | | | SM9707 ³⁾ SM9709 ⁴⁾ | |

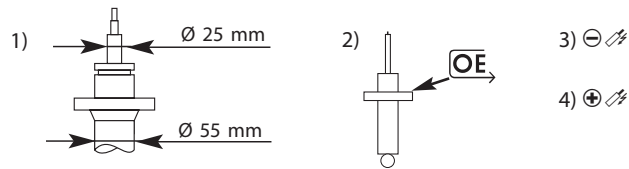

Sharan

| | | | | | | | | | |
|-------------------------------|-------------|--|----------------------|--|--|--|----------------------|--------|--|
| (7M) Incl. Sport sus., | 5.95 - 3.10 | | 334947 | | | | 343319 | 553244 | |
| (7N) Incl. Sport sus. | 5.10 - | | 335808 325700 | | | | 344459 354006 | | |

1) Exc. Sport sus. 2) Sport sus.

Taro

| | | | | | | | | | |
|--------------------------|--------------|--------|--------|---------|--|----------------------|----------------------|----------------------|--|
| 1.8, 2.2, 2.4 Diesel | 2.89 - 10.91 | 443214 | 343198 | 553117 | | 443217 | | 553118 | |
| 1.8, 2.2, 2.4 Diesel | 10.91 - 3.97 | 443214 | 343198 | 553117 | | 443259 | 343252▼ | 553209 | |
| 4x4 | 2.89 - 3.97 | 443106 | 343195 | 553110▼ | | 443257 L 443254 R | 343253 L 343246 R | 553190 L 553191 R | |
| extra cabin | 2.89 - 3.97 | 444103 | 344202 | 554069 | | 443257 L 443254 R | 343253 L 343246 R | 553190 L 553191 R | |



| MODEL FAHRZEUG MODELE | YEAR JAHR ANNEE | FRONT/VORNE/AVANT | | | | REAR/HINTEN/ARRIERE | | | |
|--|-----------------------|-----------------------------|-----------------------------|---|--|-----------------------------|--|--------------------------------|--|
| | | PREMIUM Twin-tube Oil | EXCEL-G Twin-tube Gas | GAS-A-JUST Mono-tube Gas | | PREMIUM Twin-tube Oil | EXCEL-G Twin-tube Gas | GAS-A-JUST Mono-tube Gas | |
| Volkswagen (D) | | | | | | | | | |
| T-Cross | | | | | | | | | |
| 1.0 TSi, 1.5 TSi, 1.6 TDi Exc. Flexfuel | (C11) | 12.18- | | 3348090 | | | 3430074 | | |
| Tiguan | | | | | | | | | |
| Incl. Sport sus. Exc. | (5N) | 9.07 - 7.18 | | 3358000 | | | 349067 | | |
| | | | | 910004 ¹⁾ SM1714 910059 ²⁾ | | | 910056 SM9709 | | |
| Incl. Sport sus. Exc. eHybrid, | (AD1, AX1) | 1.16 - | | 3358020 | | | 3448024 | | |
| | | | | SM1051 ³⁾ | | | 910332 ⁴⁾ | | |
| 1.4 eHybrid Exc. | (AD1, AX1) | 11.20 - | | 3358020 | | | | | |
| 1) , BlueMotion 2) Exc. BlueMotion 3) →1.17 4) Bumper height : 127 mm Exc. Sport sus., | | | | | | | | | |
| Tiguan Allspace | | | | | | | | | |
| Incl. Sport sus. Exc. E100 Flex, | (BW2, BJ2) | 4.17 - | | 3358020 | | | 3448024 | | |
| | | | | SM1051 ¹⁾ | | | 910332 | | |
| Exc. | (BW2, BJ2) | 4.17 - | | 3358020 | | | | | |
| | | | | SM1051 ¹⁾ | | | 910332 | | |
| 1) →1.18 | | | | | | | | | |
| Touran | | | | | | | | | |
| Exc. Sport sus., | (1T1, 1T2) | 2.03 - 5.10 | | 335808 <u>325700</u> | | | 344459 <u>354006</u> | | |
| | | | | 910004 SM1714 | | | 910056 ¹⁾ SM9709 ¹⁾ 910045 ²⁾ SM9708 ²⁾ | | |
| 1) OE = & → SM9709 2) OE = & → SM9708 | | | | | | | | | |



Volkswagen

| MODEL FAHRZEUG MODELE | YEAR JAHR ANNEE | FRONT/VORNE/AVANT | | | | REAR/HINTEN/ARRIERE | | | |
|--|-----------------------|-----------------------------|---|--------------------------------|--|---|-----------------------------|--------------------------------|--|
| | | PREMIUM Twin-tube Oil | EXCEL-G Twin-tube Gas | GAS-A-JUST Mono-tube Gas | | PREMIUM Twin-tube Oil | EXCEL-G Twin-tube Gas | GAS-A-JUST Mono-tube Gas | |
| Volkswagen (D) | | | | | | | | | |
| Touran | | | | | | | | | |
| (1T3) Incl. Sport sus. | 5.10 - | | 335808 325700 | | | 344459 354006 | | | |
| | | | 910004 ²⁾ SM1714 910177 ³⁾ 910059 ⁴⁾ | | | 910056 ¹⁾ SM9709 ¹⁾ | | | |
| Incl. Sport sus., Exc. | (5T1) 5.15 - | | 3358015 | | | 3448024 | | | |
| | | | SM1051 | | | SM9925 | | | |
| 1) & → SM9709 2) Exc. Sport sus. 3) 4) Sport sus. | | | | | | | | | |
| T-Roc | | | | | | | | | |
| (A11) 1.0 TSi, 1.5 TSi 1.6 TDi, 2.0 TDi Incl. Sport sus., Exc. | 7.17 - | | 3358015 | | | 3448027 | | | |
| | | | | | | 910332 ¹⁾ | | | |
| (A11) 1.0 TSi, 1.5 TSi, 2.0 TSi 2.0 TDi (110 kW) Incl. Sport sus., Exc. | 7.17 - | | 3358015 | | | 3448023 | | | |
| | | | | | | 910332 ¹⁾ | | | |
| (A11) 2.0 R, 2.0 TDi (140 kW) Incl. Sport sus., Exc. | 7.19 - | | | | | 3448023 | | | |
| | | | | | | 910332 ¹⁾ | | | |
| T-Roc | | | | | | | | | |
| Sport sus., Exc. | (AC7) 12.19 - | | 3358015 | | | 3448023 | | | |
| | | | | | | 910332 ¹⁾ | | | |
| 1) Sport sus. Exc. | | | | | | | | | |
| Type 181 | | | | | | | | | |
| Type 181 Jagdswagen | 10.72 - | | | | | 443047 | 343053 | | |
| Up, Load Up | | | | | | | | | |
| 1.0, 1.0 BlueMotion (12_, BL_) 1.0 Ecofuel, 1.0 GTi, 1.0 TSi (66 kW) 1.0 TSi BlueMotion Incl. Sport sus., H/D | 8.11 - | | 3338038 ¹⁾ 3338041 ²⁾ | | | 3438006 | | | |
| | | | 910221 ³⁾ SM1708 | | | 910220 ³⁾ SM9928 ⁴⁾ | | | |
| e-Up, e-Load Up Exc. | (12_, BL_) 7.13 - | | 3338041 ²⁾ | | | 3438006 | | | |
| | | | 910154 SM1708 | | | 910220 SM9928 ⁴⁾ | | | |



| MODEL FAHRZEUG MODELE | YEAR JAHR ANNEE | FRONT/VORNE/AVANT | | | | REAR/HINTEN/ARRIERE | | | |
|-----------------------------|-----------------------|-----------------------------|-----------------------------|--------------------------------|--|-----------------------------|-----------------------------|--------------------------------|--|
| | | PREMIUM Twin-tube Oil | EXCEL-G Twin-tube Gas | GAS-A-JUST Mono-tube Gas | | PREMIUM Twin-tube Oil | EXCEL-G Twin-tube Gas | GAS-A-JUST Mono-tube Gas | |

Volkswagen (D)

Up, Load Up

| | | | | | | | | | |
|---------------------|------------|--------|--------|-----------------------|--|--------|----------------------|--|--|
| e-Up, e-Load Up | (12_, BL_) | 7.13 - | | 3338041 ²⁾ | | | | | |
| | | | 910154 | SM1708 | | 910220 | SM9928 ⁴⁾ | | |

1) $\varnothing 18 \text{ mm}$ 2) $\varnothing 20 \text{ mm}$ 3) Exc. Sport sus. 4) exc. Load Up

Volkswagen Commercial (D)

Caddy, Caddy Maxi

| | | | | | | | | | |
|--|------------|--------------|--------|--|--|--|--------|--|--|
| (2WD) Exc. 2.0 EcoFuel, Caddy Maxi, H/D, | (2K_, 2C_) | 3.04 - 5.15 | | 334834 ¹⁾ 335808 ²⁾ | | | 344457 | | |
| | | | 910177 | SM1714 | | | | | |
| (2WD) 2.0 EcoFuel Exc. Caddy Maxi, H/D, | (2K_, 2C_) | 4.06 - 9.09 | | 334834 ¹⁾ 335808 ²⁾ | | | 344457 | | |
| | | | 910177 | SM1714 | | | | | |
| (2WD) 2.0 EcoFuel Exc. Caddy Maxi, H/D, | (2K_, 2C_) | 10.09 - 5.15 | | 334834 ¹⁾ 335808 ²⁾ | | | 344458 | | |
| | | | 910177 | SM1714 | | | | | |
| (2WD) Exc. Caddy Maxi, H/D, | (2K_, 2C_) | 3.04 - 5.15 | | 334834 ¹⁾ 335808 ²⁾ | | | 344458 | | |
| | | | 910177 | SM1714 | | | | | |
| (2WD) H/D, | (2K_, 2C_) | 3.04 - 5.15 | | 334834 ¹⁾ 335808 ²⁾ | | | 344458 | | |
| | | | 910177 | SM1714 | | | | | |
| (4WD) Exc. Caddy Maxi | (2K_, 2C_) | 5.08 - 5.15 | | 335808 ²⁾ | | | 349201 | | |
| | | | 910177 | SM1714 | | | | | |
| (2WD) Caddy Maxi Incl. Exc. 2.0 EcoFuel | (2K_, 2C_) | 3.04 - 5.15 | | 335808 ²⁾ | | | 349227 | | |
| | | | 910177 | SM1714 | | | | | |
| (2WD) 2.0 EcoFuel Caddy Maxi Incl. H/D, | (2K_, 2C_) | 4.06 - 5.08 | | 334834 ¹⁾ 335808 ²⁾ | | | 344458 | | |
| | | | 910177 | SM1714 | | | | | |
| (2WD) 2.0 EcoFuel Caddy Maxi Incl. H/D, | (2K_, 2C_) | 6.08 - 5.15 | | 335808 ²⁾ | | | 349227 | | |
| | | | 910177 | SM1714 | | | | | |

1) $\varnothing 22 \text{ mm}$ / $\varnothing 50 \text{ mm}$ 2) $\varnothing 25 \text{ mm}$ / $\varnothing 55 \text{ mm}$



| MODEL FAHRZEUG MODELE | YEAR JAHR ANNEE | FRONT/VORNE/AVANT | | | | REAR/HINTEN/ARRIERE | | | |
|-----------------------------|-----------------------|-----------------------------|-----------------------------|--------------------------------|--|-----------------------------|-----------------------------|--------------------------------|--|
| | | PREMIUM Twin-tube Oil | EXCEL-G Twin-tube Gas | GAS-A-JUST Mono-tube Gas | | PREMIUM Twin-tube Oil | EXCEL-G Twin-tube Gas | GAS-A-JUST Mono-tube Gas | |

Volkswagen Commercial (D)

Caddy, Caddy Maxi

| | | | | | | | | |
|--|--|----------------------|--------|--|--|--|--|--|
| (4WD) (2K_, 2C_) 5.08 - 5.15 ALL ⊕ Caddy Maxi | | 335808 ¹⁾ | | | | | | |
| | | 910177 | SM1714 | | | | | |

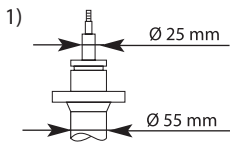

Caddy IV

| | | | | | | | | |
|---|--|--------|--------|--|--|--------|--|--|
| (SAB, SAJ, SAA, SAH) 5.15 - 9.20 2WD ALL Incl. H/D, , Reinforced rear sus., Increased payload Exc. e-Caddy | | 335808 | | | | 344458 | | |
| | | | SM1714 | | | | | |
| (SAB, SAJ, SAA, SAH) 5.15 - 9.20 4WD ALL Incl. H/D, , Reinforced rear sus. | | 335808 | | | | 349201 | | |
| | | | SM1714 | | | | | |

Caddy Maxi IV

| | | | | | | | | |
|---|--|--------|--------|--|--|--------|--|--|
| (SAB, SAJ) 5.15 - 9.20 2WD ALL Incl. H/D, Exc. CNG, e-Caddy, Reinforced rear sus., Increased payload | | 335808 | | | | 344458 | | |
| | | | SM1714 | | | | | |
| (SAB, SAJ) 5.15 - 9.20 2WD ALL ⊕ Reinforced rear sus., Increased payload Exc. CNG, e-Caddy | | 335808 | | | | 349227 | | |
| | | | SM1714 | | | | | |
| (SAB, SAJ) 6.15 - 9.20 2WD 1.4 TGI CNG Incl. H/D, , Reinforced rear sus. | | 335808 | | | | 349227 | | |
| | | | SM1714 | | | | | |
| (SAB, SAJ) 5.15 - 9.20 4WD ALL Incl. H/D, , Reinforced rear sus. | | 335808 | | | | | | |
| | | | SM1714 | | | | | |
| (SAA, SAH) 11.15 - 9.20 2WD 1.0 TSI, 1.4 TSI (96 kW), 1.6 Incl. H/D, Exc. Reinforced rear sus. | | 335808 | | | | 344458 | | |
| | | | SM1714 | | | | | |
| (SAA, SAH) 11.15 - 9.20 2WD 1.0 TSI, 1.4 TSI (96 kW), 1.6 ⊕ Reinforced rear sus. | | 335808 | | | | 349227 | | |
| | | | SM1714 | | | | | |



| MODEL FAHRZEUG MODELE | YEAR JAHR ANNEE | FRONT/VORNE/AVANT | | | | REAR/HINTEN/ARRIERE | | | |
|--|-----------------------|-----------------------------|-----------------------------|--------------------------------|--|-----------------------------|-----------------------------|--------------------------------|--|
| | | PREMIUM Twin-tube Oil | EXCEL-G Twin-tube Gas | GAS-A-JUST Mono-tube Gas | | PREMIUM Twin-tube Oil | EXCEL-G Twin-tube Gas | GAS-A-JUST Mono-tube Gas | |
| Volkswagen Commercial (D) | | | | | | | | | |
| Caddy Maxi IV | | | | | | | | | |
| (SAA, SAH) 2WD 1.4 TGI CNG, 1.4 TSI (92 kW) 1.6 TDI, 2.0 TDI Incl. H/D, , Reinforced rear sus. | 5.15 - 9.20 | | 335808 | | | | 349227 | | |
| (SAA, SAH) 4WD Incl. H/D, , Reinforced rear sus. | 5.15 - 9.20 | | 335808 | | | | | | |
| Caddy Alltrack | | | | | | | | | |
| (SAB, SAA) 2WD 4WD Incl. H/D, , Reinforced rear sus., Increased payload | 5.15 - | | 335808 | | | | 344458 | | |
| Crafter | | | | | | | | | |
| 30 2.5 TDI (kW : 65, 80, 100, 120) (2E) Exc. H/D | 4.06 - | | 331701 | | | | 343484 | | |
| | | | 940003 | | | | | | |
| 30 2.5 TDI (kW : 65, 80, 100, 120) (2E) ⊕ H/D | 4.06 - | | 331702 | | | | 349045 | | |
| | | | 940003 | | | | | | |
| 35 2.5 TDI (kW : 65, 80, 100, 120) (2E) Exc. H/D, | 4.06 - | | 331701 | | | | 343484 | | |
| | | | 940003 | | | | | | |
| 35 2.5 TDI (kW : 65, 80, 100, 120) (2E) ⊕ H/D Exc. | 4.06 - | | 331701 | | | | 349045 | | |
| | | | 940003 | | | | | | |
| 35 2.5 TDI (kW : 65, 80, 100, 120) (2E) ⊕ | 4.06 - | | 331701 | | | | 349050 | | |
| | | | 940003 | | | | | | |
| 50 2.5 TDI (kW : 65, 80, 100, 120) (2E) Exc. | 4.06 - | | 331702 | | | | 349044 | | |
| | | | 940003 | | | | | | |
| 50 2.5 TDI (kW : 80, 100, 120) (2E) ⊕ | 4.06 - | | 331702 | | | | 349051 | | |
| | | | 940003 | | | | | | |
| 30t, 35t, 50t 2.0 TDi Exc. 4WD | (2E) 5.11 - | | | | | | | | |
| | | | 940003 | | | | | | |
| Golf Caddy | | | | | | | | | |
| 11.82- 95 | | 663009 | 363001 | | | 441074 | | | |
| | | | 910088 | | | | | | |
| 96- 04 | | 633835 | 333835 | | | 443291 | 343285 | | |
| Polo Caddy | | | | | | | | | |
| 1.4, 1.6, 1.7 Sdi (9K) 1.9 SD, 1.9 SDI, 1.9 TDI (42 kW, 66 kW) 1.9 D | 96 - | 633276 | 333712 | | | 443287 | | 553231 | |
| | | | 324025 | | | | | | |
| | | | | | | | | | |



| MODEL FAHRZEUG MODELE | YEAR JAHR ANNEE | FRONT/VORNE/AVANT | | | | REAR/HINTEN/ARRIERE | | | |
|-----------------------------|-----------------------|-----------------------------|-----------------------------|--------------------------------|--|-----------------------------|-----------------------------|--------------------------------|--|
| | | PREMIUM Twin-tube Oil | EXCEL-G Twin-tube Gas | GAS-A-JUST Mono-tube Gas | | PREMIUM Twin-tube Oil | EXCEL-G Twin-tube Gas | GAS-A-JUST Mono-tube Gas | |

Volkswagen Commercial (D)

Transporter, Bus, Caravelle, Multivan

| | | | | | | | | | |
|--|----------------------------------|--------|---------|---------|--|---------|---------|---------|--|
| Type II | 65 - 5.67 | 443045 | 343087▼ | | | 443045 | 343087▼ | | |
| Type II | 6.67 - 6.69 | | | | | 444002▼ | | 554060 | |
| Type II | 7.69 - 78 | 443051 | 343181▼ | 553132 | | 444002▼ | | 554060 | |
| Type III (2WD) | 80 - 7.90 | 445019 | 345006▼ | 551049▼ | | 445020 | | 554066▼ | |
| Type IV Caravelle, Multivan Incl. Syncro (4WD) Exc. | (T4) 9.90 - 9.03 93 - 9.03 | 444119 | 344261 | | | | 341846 | | |

Transporter V, California V, Caravelle V, Multivan V

| | | | | | | | | | |
|--|-------------|--|--|--|--|--|--------|--|--|
| ALL Incl. Exc. Sport sus., H/D | (7_) 4.03 - | | 335607 ¹⁾ ▼ 335840 ¹⁾ | | | | 344456 | | |
| ALL ⊕ Sport sus., H/D | (7_) 4.03 - | | 335607 ¹⁾ ▼ 335839 ¹⁾ | | | | 344456 | | |

∞ 910136

Transporter VI, California VI, Caravelle VI, Multivan VI

| | | | | | | | | | |
|--|-------------|--|--|--|--|--|--------|--|--|
| ALL Incl. Exc. e-Caravelle, e-Transporter Exc. Sport sus., H/D, Comfort sus., Reinforced wheel sus., | (S_) 4.15 - | | 335840 ¹⁾²⁾ | | | | 344456 | | |
| ALL ⊕ Sport sus. Exc. e-Caravelle, e-Transporter | (S_) 4.15 - | | 335839 ¹⁾³⁾ | | | | 344456 | | |
| ALL ⊕ H/D, Reinforced wheel sus. Exc. e-Caravelle, e-Transporter | (S_) 4.15 - | | 335840 ¹⁾²⁾ 335839 ¹⁾³⁾ | | | | 344456 | | |
| ALL ⊕ Comfort sus. Exc. e-Caravelle, e-Transporter | (S_) 4.15 - | | | | | | 344456 | | |

1)
2) ⊕ OE 7E5413031A, 7E5413031C, 7E5413031H, 7H0413031K, 7H0413031N

3) ⊕ OE 7E0413031C, 7E0413031D, 7E5413031D, 7E5413031G, 7H0413031L, 7H5413031K



← Only for Mounting type



| MODEL FAHRZEUG MODELE | YEAR JAHR ANNEE | FRONT/VORNE/AVANT | | | | REAR/HINTEN/ARRIERE | | | |
|---|--------------------------------------|-----------------------------|-----------------------------|--------------------------------|--|-----------------------------|-----------------------------|--------------------------------|--|
| | | PREMIUM Twin-tube Oil | EXCEL-G Twin-tube Gas | GAS-A-JUST Mono-tube Gas | | PREMIUM Twin-tube Oil | EXCEL-G Twin-tube Gas | GAS-A-JUST Mono-tube Gas | |
| Volkswagen Commercial (D) | | | | | | | | | |
| Transporter LT Series | | | | | | | | | |
| LT 28/31/35 → 28D007273 | 75 - 11.82 | 444050 | | | | 444051▼ | | | |
| LT 28/28 D/31/31 D/35/35 D 28D007274 → | 83 - 96 | 444050 | | | | 444096 | | | |
| LT28 (1350kg 1600kg) LT35 (1350kg 1600kg) Incl. | 5.96 - 7.06 | | 335810 | | | 444161 | | | |
| | | 940001 SM5445 | | | | | | | |
| LT35 (1750kg) Incl. | 5.96 - 7.06 | | 335809 | | | 444161 | | | |
| | | 940001 SM5445 | | | | | | | |
| LT46 (1350kg 1600kg) Incl. | 5.96 - 7.06 | | 335810 | | | 444262 | 344409 | | |
| | | 940001 SM5445 | | | | | | | |
| LT46 (1750kg) | 5.96 - 7.06 | | 335809 | | | 444262 | 344409 | | |
| | | 940001 SM5445 | | | | | | | |
| Volvo (S) | | | | | | | | | |
| 66 | | | | | | | | | |
| DAF 66 Volvo 66 | 72 - 8.78 76 - 8.78 | 665009 | | | | 443063 | | | |
| 242, 244, 245, 264, 265, 240, 260 Series | | | | | | | | | |
| Exc. GLT, GLE, Turbo Exc. | 74 - 93 | 665008 | 365006 | | | 443062 | 343010 | | |
| | | 913116 SM5050 | | | | | | | |
| GLT, GLE, Turbo Exc. | 9.80 - 93 | | | | | 443062 | 343010 | | |
| | | | | SM5050 | | | | | |
| 300 Series | | | | | | | | | |
| 343, 345 340, 360 | 76 - 8.82 82 - 7.91 | 665010 | | | | 443050 | | | |
| | | 913217▼ | | | | | | | |
| 400 Series | | | | | | | | | |
| 440 460 | (KX) 8.88 - 6.97 (LX) 8.89 - 6.97 | 633123 L 633122 R | 333101 L▼ 333100 R▼ | | | 443252 | 343243 | | |
| | | 916501▼ MB1901 | | | | | | | |
| 480 | (EX) 85 - 7.95 | | 333102 | | | | 343243 | | |
| | | 916501▼ MB1901 | | | | | | | |



Volvo

| MODEL FAHRZEUG MODELE | YEAR JAHR ANNEE | FRONT/VORNE/AVANT | | | | REAR/HINTEN/ARRIERE | | | |
|---|---------------------------------|-----------------------------|-----------------------------|--------------------------------|--|-----------------------------|-----------------------------|--------------------------------|--|
| | | PREMIUM Twin-tube Oil | EXCEL-G Twin-tube Gas | GAS-A-JUST Mono-tube Gas | | PREMIUM Twin-tube Oil | EXCEL-G Twin-tube Gas | GAS-A-JUST Mono-tube Gas | |
| Volvo (S) | | | | | | | | | |
| 740, 760 | | | | | | | | | |
| → 81679 | 2.82 - 4.84 | | | | | 444082 | 344056 Exc. | | |
| 81680 → Exc. Turbo, Turbo -16V | 5.84 - 7.87 | 665055 913117 ▼ SM5092 | 365053 | | | 444082 | 344056 Exc. | | |
| Turbo 81680 → Exc. Turbo -16V | 5.84 - 7.87 | | 365053 | | | | 344056 Exc. | | |
| 740 Exc. Turbo, Turbo -16V | 8.87 - 92 | 665055 913117 ▼ SM5092 | 365053 | | | 444082 | 344056 Exc. | | |
| 740 Turbo Exc. Turbo -16V | 8.87 - 92 | | 365053 | | | | 344056 Exc. | | |
| 760 Exc. Turbo | 8.87 - 92 | 665055 913117 ▼ SM5092 | 365053 | | | | OE = | | |
| 740 Turbo-16V, 760 Turbo | 8.87 - 92 | | 365053 | | | | OE = | | |
| 740, 745, 760 | | | | | | | | | |
| Exc. Turbo | 2.85 - 92 | 665055 913117 ▼ SM5092 | 365053 | | | 444082 | 344056 Exc. | | |
| Turbo | 2.85 - 92 | | 365053 | | | | 344056 Exc. | | |
| 780 | | | | | | | | | |
| Exc. Turbo | 85 - 7.87 | 665055 913117 ▼ SM5092 | 365053 | | | 444082 | 344056 Exc. | | |
| Turbo | 85 - 7.87 | | 365053 | | | | 344056 Exc. | | |
| Exc. Turbo | 8.87 - 91 | 665055 913117 ▼ SM5092 | 365053 | | | | OE = | | |
| Turbo | 8.87 - 91 | | 365053 | | | | OE = | | |
| 850 | | | | | | | | | |
| Exc. | (LS) (LW) 91 - 97 92 - 97 | 634908 910083 SM5165 | | | | | 344230 Exc. | | |
| | | | | | | | SM5220 | | |



| MODEL FAHRZEUG MODELE | YEAR JAHR ANNEE | FRONT/VORNE/AVANT | | | | REAR/HINTEN/ARRIERE | | | |
|--|-----------------------|-----------------------------|-----------------------------|--------------------------------|--|-----------------------------|-----------------------------|--------------------------------|--|
| | | PREMIUM Twin-tube Oil | EXCEL-G Twin-tube Gas | GAS-A-JUST Mono-tube Gas | | PREMIUM Twin-tube Oil | EXCEL-G Twin-tube Gas | GAS-A-JUST Mono-tube Gas | |
| Volvo (S) | | | | | | | | | |
| 940 | | | | | | | | | |
| ALL Exc. Turbo, Turbo -16V | 90- 96 | 665055 | 365053 | | | 444082 | 344056 | | |
| | | ☺☺☺☺ 913117▼ SM5092 | | | | | Exc. | | |
| Turbo Exc. Turbo -16V | 90- 96 | | 365053 | | | | 344056 | | |
| | | ☺☺☺☺ 913117▼ SM5092 | | | | | Exc. | | |
| Turbo -16V | 90- 96 | | 365053 | | | | | | |
| | | ☺☺☺☺ 913117▼ SM5092 | | | | | OE = | | |
| 960 | | | | | | | | | |
| ALL Exc. Turbo | 90- 94 | 665055 | 365053 | | | | | | |
| | | ☺☺☺☺ 913117▼ SM5092 | | | | | OE = | | |
| Turbo | 90- 94 | | 365053 | | | | | | |
| | | ☺☺☺☺ 913117▼ SM5092 | | | | | OE = | | |
| ALL Exc. Turbo | 90- 94 | 665055 | 365053 | | | 444082 | 344056 | | |
| | | ☺☺☺☺ 913117▼ SM5092 | | | | | Exc. | | |
| Turbo | 90- 94 | | 365053 | | | | 344056 | | |
| | | ☺☺☺☺ 913117▼ SM5092 | | | | | Exc. | | |
| 960 II | | | | | | | | | |
| 2.5, 2.9 | 7.94- 12.96 | | | | | | | | |
| | | ☺☺☺☺ 913117▼ | | | | | | | |
| Amazon | | | | | | | | | |
| P 121, P 122, P 122 S, P 131, P 132 | 57- 70 | 443056 | | 553020 | | 443057 | | 553021 | |
| P 121, P 221 | 62- 70 | 443056 | | | | | | | |
| C30 | | | | | | | | | |
| 1.6, 1.6 D, 1.6 D2, 1.8 1.8 Flexfuel, 2.0, 2.0 D 2.0 Flexfuel, 2.4, D3, D4, D5, T5 | 10.06- | | 334843 L 334842 R | | | | 343419 | | |
| | | | SM5589 | | | ☺☺☺☺ 910217 | SM9910 ¹⁾ | | |
| 1) Marked 37, 38 OE = 30714349, 30760162 | | | | | | | | | |



Volvo

| MODEL FAHRZEUG MODELE | YEAR JAHR ANNEE | FRONT/VORNE/AVANT | | | | REAR/HINTEN/ARRIERE | | | |
|---|------------------------------|-----------------------------|-----------------------------|--------------------------------|--|-----------------------------|-----------------------------|--------------------------------|--|
| | | PREMIUM Twin-tube Oil | EXCEL-G Twin-tube Gas | GAS-A-JUST Mono-tube Gas | | PREMIUM Twin-tube Oil | EXCEL-G Twin-tube Gas | GAS-A-JUST Mono-tube Gas | |
| Volvo (S) | | | | | | | | | |
| P 142, P 144, P 145, P 164 | | | | | | | | | |
| P 142, P 144, P 164 + S P 145, P 145 S | 66 - 8.71 67 - 8.71 | 443059 | | | | 443060 | | | |
| P 142, P 144, P 164 + S P 145, P 145 S | 9.71 - 8.74 | 443059 | | | | 443061 | 343012 | 554020 | |
| PV 444, PV 544, P 210 | | | | | | | | | |
| PV 444, PV 544 PV 445, P 210 | 45 - 66 57 - 63 | 443054 | | | | | | | |
| S40 , V 40 | | | | | | | | | |
| Incl. ABS Exc. Sport sus., T4 | 5.95 - 6.99 | | 334155 L 334154 R | | | | 341204 | | |
| | | | | | | | Exc. | | |
| | | | | | | | | | |
| | | | | | | | | | |
| | | | | | | | | | |
| Incl. ABS Exc. Sport sus., T4 | 5.95 - 6.99 | | 334175 L 334174 R | | | | 341217 | | |
| | | | | | | | Exc. | | |
| | | | | | | | | | |
| | | | | | | | | | |
| | | | | | | | | | |
| Incl. ABS Exc. Sport sus., T4 | 7.99 - 4.00 | | 334355 L 334354 R | | | | 341217 | | |
| | | | | | | | Exc. | | |
| | | | | | | | | | |
| | | | | | | | | | |
| Exc. Sport sus., T4, | 5.00 - 12.03 | | 334439 L 334438 R | | | | 341145 | | |
| | | | | | | | Exc. | | |
| | | | | | | | | | |
| | | | | | | | | | |
| 1.9 T4 2.0 T4 Exc. Sport sus. | 5.97 - 7.00 7.00 - 6.04 | | | | | | | | |
| | | | | | | | | | |
| | | | | | | | | | |
| 1) Exc. 2) → 4.00 | | | | | | | | | |
| S40 , V 50 | | | | | | | | | |
| (544, 545) 1.8, 2.4, 2.4i, 2.0D, 2.0, 2.0 Flexfuel 2.5 T5, D2, D3, D4, D5 | 4.04 - 12.12 | | 334843 L 334842 R | | | | 343419 | | |
| | | | | | | | Exc. | | |
| | | | | | | | | | |
| | | | | | | | | | |
| T5 AWD (544, 545) 1.6 D2 | 4.04 - 12.10 1.10 - 12.12 | | | | | | | | |
| | | | | | | | | | |
| | | | | | | | | | |



| MODEL FAHRZEUG MODELE | YEAR JAHR ANNEE | FRONT/VORNE/AVANT | | | | REAR/HINTEN/ARRIERE | | | |
|---|---------------------------------|-----------------------------|--|--------------------------------|--|--|-----------------------------|--------------------------------|--|
| | | PREMIUM Twin-tube Oil | EXCEL-G Twin-tube Gas | GAS-A-JUST Mono-tube Gas | | PREMIUM Twin-tube Oil | EXCEL-G Twin-tube Gas | GAS-A-JUST Mono-tube Gas | |
| Volvo (S) | | | | | | | | | |
| V40 | | | | | | | | | |
| (525, 526) Exc. Polestar Performance | 3.12 - | | | | | | 349194 ¹⁾ | 553389 ²⁾ | |
| 1) | | 2) | | | | | | | |
| V40 Cross Country | | | | | | | | | |
| (525, 526) T3, T4 (140 kW) D2 (88 kW) D3 | 2.15 - 2.15 - 4.15 - | | | | | | | 553389 | |
| (525, 526) T4 (132 kW), T4 GTDi, T5 (157 kW, 187 kW) D2 (84 kW), D4 D3 → 99300 | 3.12 - 3.12 - 3.12 - 3.15 | | | | | | | 553389 | |
| (525, 526) T4 (132 kW), T4 GTDi, T5 (187 kW) D2 (84 kW), D4 D3 99301 → | 3.12 - 3.12 - 3.12 - 3.15 | | | | | | | 553390 | |
| (525, 526) T5 (157 kW) 99301 → 133113 | 3.13 - 12.15 | | | | | | | 553390 | |
| S60 | | | | | | | | | |
| 2.0 T, 2.4, 2.4 Bifuel, 2.4 D5, 2.4 DT5 | 11.00 - 4.10 | | 334611 | | | | | 553385 | |
| | | 910055 | SM5475 ¹⁾ SM1022 ¹⁾ | | | | | SM5493 | |
| 2.4 T, R 2.5 T | 11.00 - 4.10 | | 334611 | | | | | | |
| | | 910055 | SM5475 | | | | | | |
| 1) | | | | | | | | | |
| S60 II | | | | | | | | | |
| (134) Exc. , Cross Country Exc. 3.0 T , 2.0 Polestar | 4.10 - | | 3358014 L 3358013 R | | | | 349122 ¹⁾ | 5550001 ²⁾ | |
| (134) + Cross Country | 7.14 - | | 3358014 L 3358013 R | | | | | | |
| | | 910216 ³⁾ | SM5676 | | | | | | |
| | | 910216 | SM5676 ⁴⁾ | | | | | | |
| 1) | | 2) | | 3) Exc. Sport sus. Marked 6, 8 | | 4) Cross Country 2.0 T5 , 2.0 D3 : → 4379 | | | |



Volvo

| MODEL FAHRZEUG MODELE | YEAR JAHR ANNEE | FRONT/VORNE/AVANT | | | REAR/HINTEN/ARRIERE | | |
|-----------------------------|-----------------------|-----------------------------|-----------------------------|--------------------------------|-----------------------------|-----------------------------|--------------------------------|
| | | PREMIUM Twin-tube Oil | EXCEL-G Twin-tube Gas | GAS-A-JUST Mono-tube Gas | PREMIUM Twin-tube Oil | EXCEL-G Twin-tube Gas | GAS-A-JUST Mono-tube Gas |

Volvo (S)

V60

| | | | | | | | |
|--|---------|--|---|--|--|---|--|
| 2WD 4WD (155, 157) ALL Exc. , , Cross Country, 3.0 T 4WD | 9.10 - | | 3358014 L 3358013 R 910216 ³⁾ SM5676 | | | 349122 ¹⁾ 5550001 ²⁾ | |
| 3.0 T 4WD (155, 157) | 4.14 - | | 910216 ³⁾ SM5676 | | | 5550001 ²⁾ | |
| 2WD 4WD (155, 157) ALL + Cross Country | 10.13 - | | 3358014 L 3358013 R 910216 SM5676 ⁴⁾ | | | | |

1) OE Ø 48 mm 2) OE Ø 50 mm 3) Exc. Sport sus. Marked 6, 8 4) Cross Country 2.0 T5 (180 kW) **4WD** : → 4379

S70 , V70 , C70

| | | | | | | | |
|--|--------------|--------|---|--|--|--------------------------|--|
| S70 2WD 4WD ALL Exc. | 1.97 - 11.00 | 634908 | | | | 344230 Exc. SM5220 | |
| C70 2WD 4WD ALL Exc. | 3.97 - 9.02 | 634908 | | | | 344230 Exc. SM5220 | |
| V70 2WD 4WD ALL Exc. | 1.97 - 3.00 | 634908 | | | | 344230 Exc. SM5220 | |
| V70 2WD 2.0 T, 2.3, 2.3 T5, 2.4, 2.4 T, 2.4 T5, 2.4 D 2.4 Bifuel, 2.4 D5, 2.5 TDI, 2.5 T Exc. AWD | 3.00 - | | 334611 910055 SM5475 ¹⁾ SM1022 ¹⁾ | | | 553385 SM5493 | |
| V70 4WD 2.4 T AWD, 2.5 T AWD Exc. | 3.00 - | | 334611 910055 SM5165 | | | | |

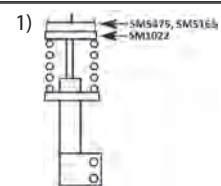

C70 II

| | | | | | | | |
|------------|--------|--|--|--------|--|--------|--|
| ALL | 3.06 - | | | | | | |
| | | | | SM5589 | | SM9910 | |



| MODEL FAHRZEUG MODELE | YEAR JAHR ANNEE | FRONT/VORNE/AVANT | | | | REAR/HINTEN/ARRIERE | | | | | | | | | | | | | |
|--|-----------------------|--|--|--|---------|--|-----------------------------|--------------------------------|--------|-------------|--------|-------------|--------|-------------|--------|--|--|--|--|
| | | PREMIUM Twin-tube Oil | EXCEL-G Twin-tube Gas | GAS-A-JUST Mono-tube Gas | | PREMIUM Twin-tube Oil | EXCEL-G Twin-tube Gas | GAS-A-JUST Mono-tube Gas | | | | | | | | | | | |
| Volvo (S) | | | | | | | | | | | | | | | | | | | |
| V70 III | | | | | | | | | | | | | | | | | | | |
| (2WD) (4WD) 1.6 T4F, 1.6 Drive, 1.6 D, 2.0, 2.0 T, 2.0 D 2.0 Flexifuel, 2.4 D, 2.5 T, 2.5 Flexifuel 3.2, T4, T5, T6, D3, D5 Exc. | 8.07 - | | 334971 L ▼ 334970 R ▼ 339719 L 339718 R | | | 349122 ²⁾ 349129 ³⁾ | | | | | | | | | | | | | |
| | | 910216 ⁴⁾ | | SM5676 ¹⁾ | | Exc. | | | | | | | | | | | | | |
| 1) Incl. | | 2) L max = 472 mm Marked 31, 32, 43 OE p/n : 30714221, 30748258, 31262390 | | 3) L max = 515 mm Marked 36, 37 OE p/n : 31212805, 31262151 | | 4) Marked 8 | | | | | | | | | | | | | |
| S80 | | | | | | | | | | | | | | | | | | | |
| Exc. , Self leveling | 5.98 - 7.06 | | 334611 910055 | SM5165 ¹⁾²⁾ SM5475 ¹⁾³⁾ SM1022 ¹⁾²⁾ | | | 553385 SM5493 | | | | | | | | | | | | |
| 1) | | 2) → 153439 | | 3) 153440 → | | | | | | | | | | | | | | | |
| S80 II | | | | | | | | | | | | | | | | | | | |
| (2WD) 1.6 Drive, 1.6 D Drive, 2.0, 2.0 T, 2.0 TDi 2.0 Flexfuel, 2.4 D, 2.5 T, 2.5 T Flexfuel T4, T5, D3 Exc. | 3.06 - | | 334971 L ▼ 334970 R ▼ 339719 L 339718 R | | | 349122 ¹⁾ 349129 ²⁾ | | | | | | | | | | | | | |
| | | 910216 ³⁾ | | SM5676 ⁴⁾ | | | | | | | | | | | | | | | |
| T6 (4WD), D5, D5 (4WD), 3.2, 3.2 (4WD) Exc. | 3.06 - | | 334971 L ▼ 334970 R ▼ 339719 L 339718 R | | | | | | | | | | | | | | | | |
| | | | | SM5676 ¹⁾ | | | | | | | | | | | | | | | |
| 1) L max = 472 mm Marked 31, 32, 43 OE p/n = 30714221, 30748258, 31262390 | | 3) Marked 8 | | 4) Incl. | | | | | | | | | | | | | | | |
| 2) L max = 515 mm Marked 36, 37 OE p/n = 31212805, 31262151 | | <table border="1"> <tr><td>2.0 Drive-E</td><td>12.14 -</td></tr> <tr><td>2.5 T (183 kW)</td><td>9.12 -</td></tr> <tr><td>2.5 T (187 kW)</td><td>1.12 -</td></tr> <tr><td>D3 (100 kW)</td><td>5.12 -</td></tr> <tr><td>D4 (133 kW)</td><td>9.13 -</td></tr> <tr><td>T5 (180 kW)</td><td>9.13 -</td></tr> </table> | | 2.0 Drive-E | 12.14 - | 2.5 T (183 kW) | 9.12 - | 2.5 T (187 kW) | 1.12 - | D3 (100 kW) | 5.12 - | D4 (133 kW) | 9.13 - | T5 (180 kW) | 9.13 - | | | | |
| 2.0 Drive-E | 12.14 - | | | | | | | | | | | | | | | | | | |
| 2.5 T (183 kW) | 9.12 - | | | | | | | | | | | | | | | | | | |
| 2.5 T (187 kW) | 1.12 - | | | | | | | | | | | | | | | | | | |
| D3 (100 kW) | 5.12 - | | | | | | | | | | | | | | | | | | |
| D4 (133 kW) | 9.13 - | | | | | | | | | | | | | | | | | | |
| T5 (180 kW) | 9.13 - | | | | | | | | | | | | | | | | | | |
| S90 , V90 | | | | | | | | | | | | | | | | | | | |
| S90 2.9 Exc. , Self Leveling | 1.97 - 5.98 | | | | | | 551922 | | | | | | | | | | | | |
| | | | | SM5092 | | | | | | | | | | | | | | | |
| V90 2.9 Exc. , Self Leveling | 1.97 - 12.98 | | | | | | 551923 ▼ | | | | | | | | | | | | |
| | | | | SM5092 | | | | | | | | | | | | | | | |



Volvo

| MODEL FAHRZEUG MODELE | YEAR JAHR ANNEE | FRONT/VORNE/AVANT | | | | REAR/HINTEN/ARRIERE | | | |
|--|-----------------------|-----------------------------|--|--------------------------------|----------------------|-----------------------------|--|--------------------------------|--|
| | | PREMIUM Twin-tube Oil | EXCEL-G Twin-tube Gas | GAS-A-JUST Mono-tube Gas | | PREMIUM Twin-tube Oil | EXCEL-G Twin-tube Gas | GAS-A-JUST Mono-tube Gas | |
| Volvo (S) | | | | | | | | | |
| XC60 I | | | | | | | | | |
| (2WD) (4WD) (156) Incl. Sport Exc. Comfort, Dynamic, Polestar, Active sus. | 5.08 - 12.17 | | 3348083 L 3348082 R | | | | | | |
| | | | 910216 | | SM5676 | | | | |
| (2WD) (4WD) (156) ⊕ Comfort, Dynamic Exc. , Sport, Polestar, Active sus. | 5.08 - 12.17 | | 334973 L ▼ 334972 R ▼ 339819 L 339818 R | | | | | | |
| | | | 910216 | | SM5676 | | | | |
| XC70 | | | | | | | | | |
| | 3.00 - | | | | | | | | |
| | | | | | | | | | |
| | | | | | | | | | |
| | | | | | | | | | |
| | | | | | | | | | |
| 1) | | | | | | | | | |
| XC70 II | | | | | | | | | |
| (2WD) (4WD) 2.4 D, 3.2, T6, D3, D5 Exc. | 8.07 - | | 334971 L ▼ 334970 R ▼ 339719 L 339718 R | | | | 349122 ²⁾ 349129 ³⁾ | | |
| | | | 910216 ⁴⁾ | | SM5676 ¹⁾ | | | | |
| 1) Incl. 2) L max = 472 mm Marked 31, 32, 43 OE p/n : 30714221, 30748258, 31262390 | | | | | | | | | |
| 3) L max = 515 mm Marked 36, 37 OE p/n : 31212805, 31262151 | | | | | | | | | |
| 4) Marked 8 | | | | | | | | | |
| XC90 I | | | | | | | | | |
| Exc. | (275) 6.02 - 1.15 | | | | | | | 553382 | |
| | | | | | | | | | |
| | | | | | | | | | |
| | | | | | | | | | |
| | | | | | | | | | |
| | | | | | | | | | |
| 1) | | | | | | | | | |



| MODEL FAHRZEUG MODELE | YEAR JAHR ANNEE | FRONT/VORNE/AVANT | | | | REAR/HINTEN/ARRIERE | | | |
|--|-----------------------|-----------------------------|-----------------------------|--------------------------------|--|-----------------------------|-----------------------------|--------------------------------|--|
| | | PREMIUM Twin-tube Oil | EXCEL-G Twin-tube Gas | GAS-A-JUST Mono-tube Gas | | PREMIUM Twin-tube Oil | EXCEL-G Twin-tube Gas | GAS-A-JUST Mono-tube Gas | |
| Wartburg (D) | | | | | | | | | |
| 1000, 313, 353, Barkas | | | | | | | | | |
| 1000, 313, 353, 353 Tourist | 57 - | 443145 | | | | 443145 | | | |
| Barkas | 62 - 65 | 443030 | | | | 443030 | | | |
| ZAZ (UA) | | | | | | | | | |
| Chance → Chevrolet - Daewoo Lanos / Sens | | | | | | | | | |
| Vida → Chevrolet - Daewoo Kalos / Aveo | | | | | | | | | |

Wartburg



A thick, vertical grey bar runs down the center of the page, serving as a background for the text.

AGX Adjustable Gas Shock Absorbers
ULTRA SR Shock Absorbers

| MODEL FAHRZEUG MODELE | YEAR JAHR ANNEE | FRONT | REAR | FRONT | REAR | FRONT | REAR | FRONT | REAR |
|--|-----------------------|-------|------|----------------------|----------------------|--------|------------------------|--------------------------------|--------------------------------|
| | | | | | | | | PROTECTION KIT MOUNTING KIT | |
| Audi (D) | | | | | | | | | |
| 50 | | | | | | | | | |
| (86) | 9.74 - 78 | | | | 351004▼ | | 341023▼ | 910088 SM1703 | 915412 ¹⁾ |
| 1) 915412 : not for 341023 and 351004 | | | | | | | | | |
| 80 / 90 , 80 Variant / Avant (78-91) | | | | | | | | | |
| 80 (Exc. Quattro) (81) | 9.78 - 86 | | | 375008 ¹⁾ | | 365500 | 341003 | 910088 SM1702 | |
| 90 (Exc. Quattro) (81) | 10.84 - 86 | | | | | | | | |
| 80 Quattro (81) | 9.83 - 8.86 | | | 375008 ¹⁾ | | 365500 | 366006 | 910088 SM1702 | |
| 90 Quattro (81) | 9.84 - 12.86 | | | | | | | | |
| Exc. Sport sus. | | | | | | | | | |
| 80 (89, 8A) | 10.86 - 8.91 | | | 375008 ¹⁾ | | 365500 | 341003 | 910088 SM1702 | |
| 90 (89, 8A) | 87 - 8.91 | | | | | | | | |
| Exc. Quattro, Sport sus., 2.3, 2.3 20V | | | | | | | | | |
| 80 Quattro (89, 8A) | 9.86 - 8.91 | | | 375008 ¹⁾ | | 365500 | 366006 | 910088 SM1702 | |
| 90 Quattro (89, 8A) | 1.87 - 8.91 | | | | | | | | |
| Exc. Sport sus., 2.3, 2.3 20V | | | | | | | | | |
| 1) | | | | | | | | | |
| 80 , 80 Variant / Avant (91-95) | | | | | | | | | |
| 1.6, 2.0, 2.0 E, 2.3 E (8C, B4) | 9.91 - 95 | | | 375008 ¹⁾ | | 365500 | 341130 | 910088 SM1702 | SM9705 |
| 1.9 TD, 1.9 TDI | | | | | | | | | |
| Exc. Sport sus., Quattro, | | | | | | | | | |
| 2.6 E, 2.8 E (8C, B4) | 9.91 - 95 | | | 375008 ¹⁾ | | 365500 | 341130 | 910088 SM1702 | SM9705 |
| Exc. Sport sus., Quattro | | | | | | | | | |
| (8C, B4) | 9.91 - 95 | | | 375008 ¹⁾ | | 365500 | 341132▼ | SM1702 | SM9705 |
| ⊕ Sport sus. | | | | | | | | | |
| Exc. Quattro | | | | | | | | | |
| Quattro (8C, B4) | 92 - 95 | | | 375008 ¹⁾ | | 365500 | | SM1702 | |
| Incl. Sport sus. | | | | | | | | | |
| Exc. SR, RS2 | | | | | | | | | |
| 1) | | | | | | | | | |
| 100 , 100 Avant | | | | | | | | | |
| (44, C3) | 9.82 - 90 | | | 376001 | | 366002 | 341016▼ | 915702▼ 910089 SM1710▼ | SM9701 |
| Exc. Quattro | | | | | | | | | |
| (4A, C4) | 12.90 - 94 | | | 376001 | 351018 ¹⁾ | 366002 | 341133 ¹⁾ | 915703▼ 910089 SM5183▼ | 915705 ¹⁾ SM9701 |
| Exc. Sport sus., Quattro, S4, | | | | | | | | | |
| (4A, C4) | 12.90 - 94 | | | 376001 | 351018 ¹⁾ | 366002 | 341133 ¹⁾ | SM5183▼ | SM9701 |
| ⊕ Sport sus. | | | | | | | | | |
| Exc. Quattro, S4 | | | | | | | | | |
| 200 , 200 Avant | | | | | | | | | |
| (44, C3) | 9.83 - 90 | | | 376001 | | 366002 | 341016 ¹⁾ ▼ | 915702▼ 910089 SM1710▼ | SM9701 |
| Exc. Quattro | | | | | | | | | |
| 1) Exc. | | | | | | | | | |

| MODEL FAHRZEUG MODELE | YEAR JAHR ANNEE | FRONT | REAR | FRONT | REAR | FRONT | REAR | FRONT | REAR |
|-----------------------------|-----------------------|-------|------|-------|--------------------------------|-------|------|-------|------|
| | | | | | PROTECTION KIT MOUNTING KIT | | | | |

Audi (D)

A2 (8Z0)

| | | | | | | | | | |
|--|--|--|--|----------------------|--------|----------------------|------------------|------------------|------------------|
| 1.4 (8Z0) 1.2 TDI 1.4 TDI 1.6 FSI Exc. Sport sus., | 2.00 - 8.05 3.01 - 8.05 2.00 - 8.05 5.02 - 8.05 | | | 324702 ¹⁾ | 353025 | 334835 ¹⁾ | 343328 552700 | 910084 SM1713 | 915400 SM9703 |
|--|--|--|--|----------------------|--------|----------------------|------------------|------------------|------------------|

1) Exc. 1.2 TDI



A3 (8L1)

| | | | | | | | | | |
|--|-------------|--------|--------|--------|--------|--------|------------------|------------------|------------------|
| (8L1) 1.6, 1.8, 1.8 Turbo, 1.9 TDI Exc. Sport sus. | 9.96 - 7.99 | 734033 | 743029 | 324016 | 243037 | 334812 | 343348 553206 | 915415 SM1708 | 915400 SM9704 |
| (8L1) 1.6, 1.8, 1.8 Turbo, 1.9 TDI Exc. Sport sus. | 8.99 - 4.03 | 734033 | 743029 | 324016 | 243037 | 334812 | 343348 553206 | 915415 SM1708 | 915400 SM9704 |
| (8L1) ⊕ Sport sus. | 9.96 - 7.99 | 734033 | 743029 | 324016 | 243037 | 334812 | 553206 | 915415 SM1708 | 915400 SM9704 |
| (8L1) ⊕ Sport sus. | 8.99 - 4.03 | 734033 | 743029 | 324016 | 243037 | 334812 | 553206 | 915415 SM1708 | 915400 SM9704 |
| Quattro Exc. Sport sus., S3 | 9.96 - 7.99 | | | 324016 | | 334812 | 343310 553243 | 915415 SM1708 | |
| Quattro ⊕ Sport sus. Exc. S3 | 9.96 - 7.99 | | | 324016 | | 334812 | 553243 | 915415 SM1708 | |

A3 (8P1) , A3 (8P7)

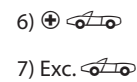
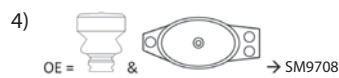
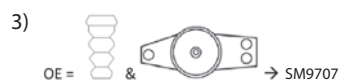
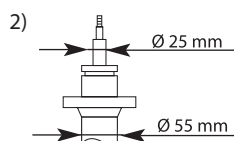
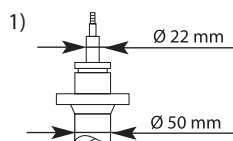



| | | | | | | | | | |
|--|--------------------------------------|--|--|--|--------|--|--------|------------------|--|
| (8P1, 8P7) 1.2 TDi, 1.2 TFSi, 1.4 TFSi 1.6 i, 1.6 FSi, 1.6 TDi, 1.6 Epower 1.8 TFSi, 1.9 TDi, 2.0 FSi, 2.0 TDi, 2.0 TFSi Exc. Sport sus., , Quattro | 5.03 - | | | 324703 ¹⁾ 325700 ²⁾ | 354006 | 334834 ¹⁾ 335808 ²⁾ | 344459 | 910004 SM1714 | 910002 ⁴⁾⁷⁾ 910180 ⁵⁾⁷⁾ SM9707 ³⁾⁶⁾ SM9708 ⁴⁾⁷⁾ SM9709 ⁵⁾⁷⁾ |
| (8P1) 1.8 TFSi Quattro 2.0 TDi Quattro 2.0 TFSi Quattro 3.2 V6 Quattro Exc. Sport sus., | 7.08 - 5.03 - 9.04 - 7.03 - | | | 325700 ²⁾ | 354006 | 335808 ²⁾ | 344459 | 910004 SM1714 | 910002 ⁴⁾ 910180 ⁵⁾ SM9708 ⁴⁾ SM9709 ⁵⁾ |



| MODEL FAHRZEUG MODELE | YEAR JAHR ANNEE | FRONT | REAR | FRONT | REAR | FRONT | REAR | FRONT | REAR |
|-----------------------------|-----------------------|---|------|--|------|---|------|--|------|
| | |  | |  | |  | | PROTECTION KIT MOUNTING KIT | |

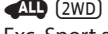





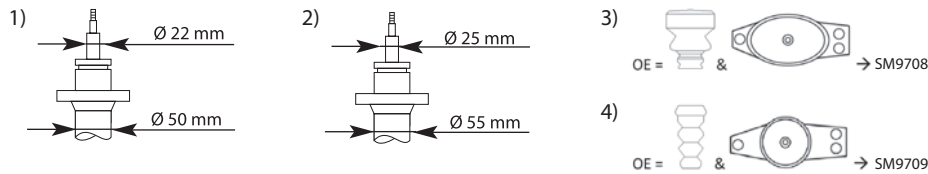



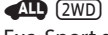



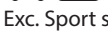
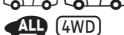

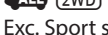

Audi (D)

A3 Sportback (8PA)

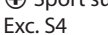
| | | | | | | | | | |
|---|---------------------------------------|--|--|--|--------|--|--------|------------------|--|
|  (8PA) Exc. Sport sus.,  Quattro | 9.04 - | | | 324703 ¹⁾ 325700 ²⁾ | 354006 | 334834 ¹⁾ 335808 ²⁾ | 344459 | 910004 SM1714 | 910002 ³⁾ 910180 ⁴⁾ SM9708 ³⁾ SM9709 ⁴⁾ |
|  (8PA) 1.8 TFSi Quattro 2.0 TDi Quattro 2.0 TFSi Quattro 3.2 V6 Quattro Exc. Sport sus.,  | 7.08 - 11.05 - 9.04 - 9.04 - | | | 325700 ²⁾ | 354006 | 335808 ²⁾ | 344459 | 910004 SM1714 | 910002 ³⁾ 910180 ⁴⁾ SM9708 ³⁾ SM9709 ⁴⁾ |

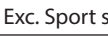

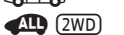





























A4 (8D2) , A4 Avant (8D5)













| | | | | | | | | | |
|--|--------------|--|--|--------|------------------------|--------|----------------------|--|--------------------------------|
|  (8D*, B5)  Exc. Sport sus. | 11.94 - 1.99 | | | 351700 | 353014 ¹⁾ | 341842 | 343271 ¹⁾ | 915708 SM1711 ²⁾ ▼ SM5236 ²⁾ | 915416 SM5377 ²⁾ |
|  (8D*, B5)  ⊕ Sport sus. | 11.94 - 1.99 | | | 351700 | 353014 ¹⁾ | | 343271 ¹⁾ | 915708 SM1711 ²⁾ ▼ SM5236 ²⁾ | 915416 SM5377 ²⁾ |
|  (8D*, B5)  Exc. Sport sus., S4 | 11.94 - 1.99 | | | 351700 | | 341842 | 341909 | 915708 SM1711 ²⁾ ▼ SM5236 ²⁾ | |
|  (8D*, B5)  ⊕ Sport sus. Exc. S4 | 11.94 - 1.99 | | | 351700 | | | 341909 | 915708 SM1711 ²⁾ ▼ SM5236 ²⁾ | |
|  (8D2, B5)  Exc. Sport sus.,  | 2.99 - 11.00 | | | 351700 | 353016 ¹⁾ ▼ | 341842 | 343302 ¹⁾ | 915708 SM1712 ²⁾ ▼ SM5236 ²⁾ | SM5377 ²⁾ |
|  (8D2, B5)  ⊕ Sport sus. | 2.99 - 11.00 | | | 351700 | 353016 ¹⁾ ▼ | | 343302 ¹⁾ | 915708 SM1712 ²⁾ ▼ SM5236 ²⁾ | SM5377 ²⁾ |
|  (8D2, B5)  Exc. Sport sus., S4 | 2.99 - 11.00 | | | 351700 | | 341842 | 341909 | 915708 SM1712 ²⁾ ▼ SM5236 ²⁾ | |
|  (8D2, B5)  ⊕ Sport sus. Exc. S4 | 2.99 - 11.00 | | | 351700 | | | 341909 | 915708 SM1712 ²⁾ ▼ SM5236 ²⁾ | |
|  (8D5, B5)  Exc. Sport sus.,  | 2.99 - 9.01 | | | 351700 | 353016 ¹⁾ ▼ | 341842 | 343302 ¹⁾ | 915708 SM1712 ²⁾ ▼ SM5236 ²⁾ | SM5377 ²⁾ |
|  (8D5, B5)  ⊕ Sport sus. | 2.99 - 9.01 | | | 351700 | 353016 ¹⁾ ▼ | | 343302 ¹⁾ | 915708 SM1712 ²⁾ ▼ SM5236 ²⁾ | SM5377 ²⁾ |

| MODEL FAHRZEUG MODELE | YEAR JAHR ANNEE | FRONT | REAR | FRONT | REAR | FRONT | REAR | FRONT | REAR | | | | | | | | | | | | | | | | | | | | | |
|---|----------------------------|----------------|--|----------------------|----------------------|--------|----------------------|--|------------------|--|--|--|--|----------|--|---------------|--|----------|--|--------------|--------|--|--|--------|--|----------------|---|--|---------------|--|
| | | | | | | | | PROTECTION KIT MOUNTING KIT | | | | | | | | | | | | | | | | | | | | | | |
| Audi (D) | | | | | | | | | | | | | | | | | | | | | | | | | | | | | | |
| A4 (8D2) , A4 Avant (8D5) | | | | | | | | | | | | | | | | | | | | | | | | | | | | | | |
| (8D5, B5) Exc. Sport sus., S4 | 2.99 - 9.01 | | | 351700 | | 341842 | 341909 | 915708 SM1712 ²⁾ ▼ SM5236 ²⁾ | | | | | | | | | | | | | | | | | | | | | | |
| (8D5, B5) ⊕ Sport sus. Exc. S4 | 2.99 - 9.01 | | | 351700 | | | 341909 | 915708 SM1712 ²⁾ ▼ SM5236 ²⁾ | | | | | | | | | | | | | | | | | | | | | | |
| 1) 2) <table border="1"> <thead> <tr> <th></th> <th></th> <th></th> <th></th> </tr> </thead> <tbody> <tr> <td>SM1711 ▼</td> <td></td> <td>→ 8D-W-012335</td> <td rowspan="4">See pictures in section suspension mounting type numerical listing</td> </tr> <tr> <td>SM1712 ▼</td> <td></td> <td>8D-W-012335→</td> </tr> <tr> <td>SM5236</td> <td></td> <td></td> </tr> <tr> <td>SM5377</td> <td></td> <td>→ 8D-X-199 999</td> </tr> <tr> <td>∅</td> <td></td> <td>8D-X-200 001→</td> <td></td> </tr> </tbody> </table> | | | | | | | | | | | | | | SM1711 ▼ | | → 8D-W-012335 | See pictures in section suspension mounting type numerical listing | SM1712 ▼ | | 8D-W-012335→ | SM5236 | | | SM5377 | | → 8D-X-199 999 | ∅ | | 8D-X-200 001→ | |
| | | | | | | | | | | | | | | | | | | | | | | | | | | | | | | |
| SM1711 ▼ | | → 8D-W-012335 | See pictures in section suspension mounting type numerical listing | | | | | | | | | | | | | | | | | | | | | | | | | | | |
| SM1712 ▼ | | 8D-W-012335→ | | | | | | | | | | | | | | | | | | | | | | | | | | | | |
| SM5236 | | | | | | | | | | | | | | | | | | | | | | | | | | | | | | |
| SM5377 | | → 8D-X-199 999 | | | | | | | | | | | | | | | | | | | | | | | | | | | | |
| ∅ | | 8D-X-200 001→ | | | | | | | | | | | | | | | | | | | | | | | | | | | | |
| A6 (4A) , A6 Avant (4A) (94 - 97) | | | | | | | | | | | | | | | | | | | | | | | | | | | | | | |
| (4A, C4) Exc. Sport sus., | 6.94 - 12.97 | | | 376001 | 351018 ¹⁾ | 366002 | 341133 ¹⁾ | 915703▼ 910089 SM5183▼ | 915705 SM9701 | | | | | | | | | | | | | | | | | | | | | |
| (4A, C4) ⊕ Sport sus. Exc. S6 | 6.94 - 12.97 | | | 376001 | 351018 ¹⁾ | 366002 | 341133 ¹⁾ | SM5183▼ | SM9701 | | | | | | | | | | | | | | | | | | | | | |
| 1) Exc. | | | | | | | | | | | | | | | | | | | | | | | | | | | | | | |
| Cabrio (8G) | | | | | | | | | | | | | | | | | | | | | | | | | | | | | | |
| (8G7, B4) | 6.91 - 8.00 | | | 375008 ¹⁾ | | 365500 | 341912 | SM1702 | | | | | | | | | | | | | | | | | | | | | | |
| 1) Exc. | | | | | | | | | | | | | | | | | | | | | | | | | | | | | | |
| Coupé | | | | | | | | | | | | | | | | | | | | | | | | | | | | | | |
| GT5E GT 1.8, 1.9, 2.0 L | 8.83 - 9.88 8.81 - 9.88 | | | 375008 ¹⁾ | | 365500 | 341003 | 910088 SM1702 | | | | | | | | | | | | | | | | | | | | | | |
| Exc. Sport sus. | (85) 9.84 - 9.88 | | | 375008 ¹⁾ | | 365500 | 366006 | 910088 SM1702 | | | | | | | | | | | | | | | | | | | | | | |
| Incl. Sport sus. | (89) 10.88 - 12.96 | | | 375008 ¹⁾ | | 365500 | 341153 | 910088 SM1702 | | | | | | | | | | | | | | | | | | | | | | |
| Exc. S2 | (89) 10.88 - 12.96 | | | 375008 ¹⁾ | | 365500 | 366008 | 910088 SM1702 | | | | | | | | | | | | | | | | | | | | | | |
| 1) | | | | | | | | | | | | | | | | | | | | | | | | | | | | | | |
| S4 | | | | | | | | | | | | | | | | | | | | | | | | | | | | | | |
| (4A, C4) ⊕ Sport sus. | 8.91 - 6.94 | | | 376001 | 351020 ²⁾ | | | SM5183 ¹⁾ ▼ | | | | | | | | | | | | | | | | | | | | | | |
| 1) ⊕ 2) Exc. | | | | | | | | | | | | | | | | | | | | | | | | | | | | | | |

| MODEL FAHRZEUG MODELE | YEAR JAHR ANNEE | FRONT | REAR | FRONT | REAR | FRONT | REAR | FRONT | REAR | |
|---|--|--------|----------------------|----------------------|----------------------|----------------------|------------------|------------------|--------------|--|
| | | | | | | | | PROTECTION KIT | MOUNTING KIT | |
| Audi (D) | | | | | | | | | | |
| S6 | | | | | | | | | | |
| (4A, C4) | 6.94 - 10.97 | | | 376001 | 351020 ¹⁾ | | | | SM5183▼ | |
| Sport sus. | | | | | | | | | | |
| 1) Exc. | | | | | | | | | | |
| Austin-Rover Group (GB) | | | | | | | | | | |
| Austin, Morris | | | | | | | | | | |
| Seven 850, Cooper (S) Mini Car 850, 1000, 1275 GT Mini Clubman Mini-Minor Mini-Cooper Hornet 1000 Mayfair Sport 1000 Mayfair 1100 Special | 59 - 74 76 - 76 - 59 - 76 61 - 64 62 - 64 1.70 - 1.70 - 1.70 - | 743044 | 743046 L 743045 R | | | 342001 552018 | 342002 552019 | | | |
| BMW (D) | | | | | | | | | | |
| 3 Series (E30) Exc. M-Technik sus. | | | | | | | | | | |
| 316, 316i, 318i, 318iS, 324d Exc. Sport sus. | (E30) 82 - 12.90 | | | 373019 ¹⁾ | 243019 | 363500 ¹⁾ | 343184 | 910084 SM1000 | SM9000 | |
| 320i Exc. Sport sus. | (E30) 82 - 9.87 | | | 373019 ¹⁾ | 243019 | 363500 ¹⁾ | 343184 | 910084 SM1000 | SM9000 | |
| 320i Exc. Sport sus. | (E30) 10.87 - 12.90 | | | 373019 ¹⁾ | 243019 | 363500 ¹⁾ | 343184 | 910084 SM1000 | SM9000 | |
| 316 / 316i Sport 318i / 318iS Sport 320i Sport 324d Sport | (E30) 82 - 12.90 | | | 374008 ²⁾ | 243019 | 364021 ²⁾ | 343184 | 910084 SM1000 | SM9000 | |
| 320iS, 323i, 324td, 325e, 325i Incl. Sport sus. Exc. (325iX) | (E30) 82 - 12.90 | | | 374008 ²⁾ | 243019 | 364021 ²⁾ | 343184 | 910084 SM1000 | SM9000 | |
| 3 Series (E30) Exc. M-Technik sus. | | | | | | | | | | |
| 318i, 320i, 325i Incl. Sport sus. Exc. (325iX) | (E30) 85 - 2.93 | | | 374008 ²⁾ | 243019 | 364021 ²⁾ | 343184 | 910084 SM1000 | SM9000 | |
| 3 Series Touring (E30) Exc. M-Technik sus. | | | | | | | | | | |
| 316i, 318i Exc. Sport sus. | (E30) 3.89 - 9.89 | | | 373019 ¹⁾ | 243019 | 363500 ¹⁾ | 343184 | 910084 SM1000 | SM9000 | |
| 316i, 318i Exc. Sport sus. | (E30) 10.89 - 2.94 | | | 374008 ²⁾ | 243019 | 364021 ²⁾ | 343184 | 910084 SM1000 | SM9000 | |
| 316i Sport 318i Sport | (E30) 3.89 - 2.94 | | | 374008 ²⁾ | 243019 | 364021 ²⁾ | 343184 | 910084 SM1000 | SM9000 | |
| 320i, 324td, 325i Incl. Sport sus. Exc. (325iX) | (E30) 88 - 2.94 | | | 374008 ²⁾ | 243019 | 364021 ²⁾ | 343184 | 910084 SM1000 | SM9000 | |

| MODEL FAHRZEUG MODELE | YEAR JAHR ANNEE | FRONT | REAR | FRONT | REAR | FRONT | REAR | FRONT | REAR |
|--|--------------------------------------|--------------------------|----------|----------------------|--------|----------------------|--------------------|--|--------|
| | | | | | | | | PROTECTION KIT MOUNTING KIT | |
| BMW (D) | | | | | | | | | |
| 3 Series (E30) ⊕ M-Technik sus. Exc. (4WD) (325iX), M3 | | | | | | | | | |
| ALL (E30) | 82 - 12.90 85 - 2.93 89 - 2.94 | | | 374008 ²⁾ | 243019 | | | SM1000 | SM9000 |
| 1) | | 2) | | | | | | | |
| Chevrolet - Daewoo (KO) | | | | | | | | | |
| Espero / Aranos | | | | | | | | | |
| ALL (KLEJ) | 10.91 - 9.99 | 765021 ▼ | | 375009 | 243014 | 365501 | 343047 553075 ▼ | 910083 SM1307 ▼ | |
| Lanos / Sens | | | | | | | | | |
| ALL (KLAT) | 5.97 - | | | 375009 | 243014 | 365501 | 343047 553075 ▼ | 910083 SM1020 L SM1021 R | |
| Nexia / Cielo | | | | | | | | | |
| ALL (KLETN) Incl. Nexia II (UzDaewoo) | 2.95 - 3.01 | 765021 ▼ | | 375009 | 243014 | 365501 | 343047 553075 ▼ | 910083 SM1307 ▼ | |
| Citroën (F) | | | | | | | | | |
| AX | | | | | | | | | |
| 10 E/RE, 11 E/RE, 11 TRE 1.3 Sport, 1.4 RE Sport 14 TRS, 14 TZS, 14 D/RD/TRD, GT 1.4 Allure 15 D Electric | (ZA) 86 - 12.98 | 765020 | 741064 | 375036 | 241006 | 365506 | 341101 | MB1901 SM1902 | |
| Saxo | | | | | | | | | |
| 1.0, 1.1, 1.4, 1.5 D Exc. 1.6 16V | (S) 2.96 - 4.04 | 765020 | 741064 | 375036 | 241006 | 365506 | 341101 | MB1901 SM1903 | |
| 1.6 16V | (S) 2.96 - 4.04 | 765020 | 741064 | 375036 | 241006 | 365506 | 341101 | MB1901 SM1903 | |
| Xsara (N1/N0) | | | | | | | | | |
| 1.4, 1.6, 2.0 16V 1.5 D, 1.8 D, 1.9 D, 1.9 TD 2.0 HDi Exc. | 97 - 9.00 | 733032 L ▼ 733031 R ▼ | 743034 ▼ | 323839 L 323838 R | 241008 | 333839 L 333838 R | 341166 | 913112 MB1901 SM1905 ¹⁾ SM1906 ²⁾ | |
| 1.8 1.8 16V Exc. | 97 - 9.00 | 733032 L ▼ 733031 R ▼ | 743034 ▼ | 323839 L 323838 R | 241008 | 333839 L 333838 R | 341166 | 913112 MB1901 SM1905 ¹⁾ SM1906 ²⁾ | |
| 1) ⊖ ⊕ | | 2) ⊕ ⊕ | | | | | | | |

| MODEL FAHRZEUG MODELE | YEAR JAHR ANNEE | FRONT | REAR | FRONT | REAR | FRONT | REAR | FRONT | REAR |
|---|--|--|---------|--|--------|---|--------|--|------|
| | |  | |  | |  | | PROTECTION KIT MOUNTING KIT | |
| Citroën (F) | | | | | | | | | |
| Xsara (N1/N0)   | | | | | | | | | |
| 1.4 HDi 1.6 16V 1.9 D 1.8 VTS Coupe 2.0 i 2.0 HDi Exc.  , 2.0 VTS 16V | 1.03 - 3.05 9.00 - 3.05 9.00 - 3.05 9.00 - 3.05 9.00 - 3.05 9.00 - 3.05 | | | 323735 L 323734 R | 241008 | 333735 L 333734 R | 341166 | MB1901 | |
| 1)   | | 2)   | | | | | | | |
| Xsara (N2)  | | | | | | | | | |
| 1.4, 1.6, 1.8, 2.0 1.5 D, 1.8 D, 1.9 D, 1.9 TD 2.0 HDi Exc.  | 97 - 9.00 | 733032 L▼ 733031 R▼ | 743034▼ | 323839 L 323838 R | 241008 | 333839 L 333838 R | 341166 | 913112 MB1901 SM1905 ¹⁾ SM1906 ²⁾ | |
| 1.4 HDi 1.6 i 1.9 D 2.0 i 2.0 HDi Exc.  | 1.03 - 8.05 9.00 - 8.05 9.00 - 8.05 9.00 - 8.05 9.00 - 8.05 | | | 323735 L 323734 R | 241008 | 333735 L 333734 R | 341166 | MB1901 | |
| 1)   | | 2)   | | | | | | | |
| ZX  | | | | | | | | | |
| 1.6, 1.8 (N2) | 91 - 7.97 | 733032 L▼ 733031 R▼ | 743034▼ | 323839 L 323838 R | 241008 | 333839 L 333838 R | 341166 | 913112 MB1901 SM1905 ¹⁾ SM1906 ²⁾ | |
| 1.9 Diesel  ABS  5684 → Exc. Turbo Diesel | (N2) 6.92 - 7.97 | 733032 L▼ 733031 R▼ | 743034▼ | 323839 L 323838 R | 241008 | 333839 L 333838 R | 341166 | 913112 MB1901 SM1905 ¹⁾ SM1906 ²⁾ | |
| 1.9 Turbo Diesel Exc. Volcane | (N2) 91 - 7.97 | 733032 L▼ 733031 R▼ | 743034▼ | 323839 L 323838 R | 241008 | 333839 L 333838 R | 341166 | 913112 MB1901 SM1905 ¹⁾ SM1906 ²⁾ | |
| 1.9 Turbo Diesel Volcane 1.9 i  5684 → 2.0 i  5684 → Exc. 16V | (N2) 91 - 7.97 5.92 - 7.97 5.92 - 7.97 | 733032 L▼ 733031 R▼ | 743034▼ | 323839 L 323838 R | 241008 | 333839 L 333838 R | 341166 | 913112 MB1901 SM1905 ¹⁾ SM1906 ²⁾ | |
| 2.0 i 16V | (N2) 92 - 7.97 | 733032 L▼ 733031 R▼ | 743034▼ | 323839 L 323838 R | 241008 | 333839 L 333838 R | 341166 | 913112 MB1901 SM1905 ¹⁾ SM1906 ²⁾ | |
| 1)   | | 2)   | | | | | | | |
| ZX  | | | | | | | | | |
| 1.4 i, 1.6 i, 1.8 i 1.9 Diesel, 1.9 Turbo Diesel | (N2) 94 - 7.97 | 733032 L▼ 733031 R▼ | 743034▼ | 323839 L 323838 R | 241008 | 333839 L 333838 R | 341166 | 913112 MB1901 SM1905 ¹⁾ SM1906 ²⁾ | |
| 1)   | | 2)   | | | | | | | |

| MODEL FAHRZEUG MODELE | YEAR JAHR ANNEE | FRONT | REAR | FRONT | REAR | FRONT | REAR | FRONT | REAR |
|--|-------------------------------------|---|------|--|---------|---|------------------|--|---------|
| | |  | |  | |  | | PROTECTION KIT MOUNTING KIT | |
| Fiat (I) | | | | | | | | | |
| Cinquecento (170)  | | | | | | | | | |
| 0.7, 0.9 (170) | 92 - 3.98 | | | 323731 | 351019 | 333731 | 341189 | 915809▼ 913268 SM1813 | |
| 1.1 Incl. Sporting (170) | 94 - 3.98 | | | 323731 | 351019 | 333731 | 341189 | 915809▼ 913268 SM1813 | |
| Punto (176)   | | | | | | | | | |
| 1.1 i 55 1.2 i 60, 75, 85 1.6 i 90 Exc. 1.2 85 Sporting, 1.6 90 Sporting (176) | 93 - 9.99 | | | 324805 | 244039▼ | 333843 | 343269 554086 | 910088 SM1805 | |
| 1.7 Diesel 1.7 Turbo Diesel (176) | 93 - 9.99 | | | 324805 | 244039▼ | 334805 | 343269 554086 | 910088 SM1805 | |
| 1.4 i GT Turbo 1.2 85 Sporting 1.6 90 Sporting (176) | 93 - 9.99 97 - 9.99 95 - 9.99 | | | 324805 | 244039▼ | 334805 | 554086 | 910088 SM1805 | |
| Tempra (159)  | | | | | | | | | |
| 1.4, 1.6, 1.6 ie (159) | 90 - 96 | | | 324848 | | 333749 | 344115 554077 | 915803▼ 910086▼ SM1802 L▼ SM1803 R▼ | |
| 1.8, 1.8 ie, 2.0, 2.0 ie 1.9 Diesel, 1.9 Turbo Diesel (159) | 90 - 96 | | | 324848 | | 334848 | 344115 554077 | 916002▼ 910086▼ SM1802 L▼ SM1803 R▼ | |
| Tempra Station Wagon / Familia (159)  | | | | | | | | | |
| 1.4, 1.6, 1.6 ie Exc.  (159) | 90 - 96 | | | 324848 | | 333749 | 344115 554077 | 915803▼ 910086▼ SM1802 L▼ SM1803 R▼ | |
| 1.8, 2.0 ie 1.9 Diesel, 1.9 Turbo Diesel Exc.  (159) | 90 - 96 | | | 324848 | | 334848 | 344115 554077 | 916002▼ 910086▼ SM1802 L▼ SM1803 R▼ | |
| Tipo (160)  | | | | | | | | | |
| 1.1, 1.4, 1.6, 1.6 ie 1.7 D, 1.9 D (160) | 4.88 - 95 | | | 324848 | | 333749 | 344115 554077 | 915803▼ 910086▼ SM1802 L▼ SM1803 R▼ | |
| 1.8, 1.8 ie, 1.8 ie 16V, 1.9 TD 2.0 ie, 2.0 ie 16V (160) | 1.88 - 95 90 - 95 | | | 324848 | | 334848 | 344115 554077 | 916002▼ 910086▼ SM1802 L▼ SM1803 R▼ | |
| Uno (146)  Exc. CS | | | | | | | | | |
|  (146) | 83 - 95 | | | | 353010▼ | 333833 | | 915812 SM1800▼ | SM9801▼ |

| MODEL FAHRZEUG MODELE | YEAR JAHR ANNEE | FRONT | REAR | FRONT | REAR | FRONT | REAR | FRONT | REAR | |
|---|--|----------------------|---------|----------------------|--------|----------------------|--------|-------------------|--|--|
| | | | | | | | | PROTECTION KIT | MOUNTING KIT | |
| Ford (Europe) | | | | | | | | | | |
| Escort Mk. V, VI, XR-3, RS (90-95) | | | | | | | | | | |
| RS Cosworth (GAL) | 4.92 - 1.95 | | | 324015 | 243034 | | | | 915210▼ | |
| Focus | | | | | | | | | | |
| Exc. RS (DAW, DBW, DFW) | 10.98 - 11.04 | | 741067▼ | 323057 L 323056 R | 353022 | 333710 L 333709 R | 343290 | 915208 SM1209 | 910313 SM5206 ¹⁾ SM9942 ²⁾ | |
| 1) Incl. 910313 | | 2) Exc. 910313 | | | | | | | | |
| Focus | | | | | | | | | | |
| (DNW) | 2.99 - 11.04 | | | 323057 L 323056 R | 353023 | 333710 L 333709 R | 343291 | 915208 SM1209 | | |
| Sierra, XR-4, Cosworth | | | | | | | | | | |
| Cosworth | 86 - 90 | | | | 243034 | | 553226 | 915210▼ SM1200 | | |
| Sierra | | | | | | | | | | |
| Exc. Cosworth | 85 - 93 | | | 324015 | 243034 | 334219 | 553226 | 915210▼ SM1200 | | |
| Cosworth | 90 - 93 | | | 324015 | 243034 | 334219 | 553226 | 915210▼ SM1200 | | |
| Honda (J) | | | | | | | | | | |
| Accord / Vigor | | | | | | | | | | |
| Accord VI 2.0 16V (CG4) 3.0 V6 24V (CG2) | 2.98 - 1.03 | 741049▼ | | | | 341257 | 341258 | 912047 SM5058 | SM5058 | |
| Civic, Ballade | | | | | | | | | | |
| 1300 (EC8) 1400 (EC9, ED2) 1500 PGM-F1 (ED6, ED3) 1600 PGM-F1 (ED7, ED4) 1600 VTEC (EE9) S100001 → | 1.89 - 12.91 1.89 - 12.89 1.89 - 12.91 1.89 - 12.91 1.90 - 12.91 | | | 351009 L 351008 R | 351010 | 341088 L 341087 R | 341094 | SM5058 | SM5058 | |
| 1.3 (EG3) 1.5 (EG4, EG8) 1.6 VTEC (EG5, EH9) 1.6 VTEC VTi (EG6, EG9) | 91 - 95 | 741006 L 741005 R | 741007 | 351012 L 351011 R | 351010 | 341139 L 341138 R | 341094 | SM5058 | SM5058 | |
| 1.4 (EJ9), 1.5 (EK3), 1.6 (EK1, EK4) Incl. VTEC | 95 - 01 | 741023 | 741024 | | | 341203 | 341198 | SM5058 | SM5058 | |
| Civic CR-X / Ballade CR-X (: JHM...) | | | | | | | | | | |
| 1600 PGM-F1 (ED9) 1600 VTEC (EE8) S100001 → | 1.89 - 3.92 1.90 - 3.92 | | | 351009 L 351008 R | 351010 | 341088 L 341087 R | 341094 | SM5058 | SM5058 | |
| 1.6 VTEC (EH6) 1.6 VTEC VTi (EG2) | 4.92 - 98 | 741006 L 741005 R | 741007 | 351012 L 351011 R | 351010 | 341139 L 341138 R | 341094 | SM5058 | SM5058 | |

| MODEL FAHRZEUG MODELE | YEAR JAHR ANNEE | FRONT | REAR | FRONT | REAR | FRONT | REAR | FRONT | REAR |
|-----------------------------|-----------------------|-------|------|-------|--------------------------------|-------|------|-------|------|
| | | | | | PROTECTION KIT MOUNTING KIT | | | | |

Honda (J)

Civic Coupé / Ballade Coupé (:)

| | | | | | | | | | | |
|-----------------|--------------------------|---------|----------------------|--------|----------------------|--------|----------------------|--------|--------|--------|
| 1.5 1.6 VTEC | (EJ2) (EJ1) | 94 - 95 | 741006 L 741005 R | 741007 | 351012 L 351011 R | 351010 | 341139 L 341138 R | 341094 | SM5058 | SM5058 |
| 1.6 1.6 VTEC | (EJ6) (EJ7, EJ8, EM1) | 95 - 01 | 741023 | 741024 | | | 341203 | 341198 | SM5058 | SM5058 |

Civic

| | | | | | | | | | | |
|---|------------------|--|------------------------|--------|--|--|----------------------|--------|--|------------------|
| ALL (EM2) | 01 - | | 731004 L▼ 731003 R▼ | 741060 | | | 331009 L 331008 R | 341311 | 910018 SM5403 ¹⁾ SM5402 ²⁾ | 910102 SM5400 |
| 1.4 i 1.6 i (EP1) (EP2) | 9.01 - | | 731004 L▼ 731003 R▼ | 741060 | | | 331009 L 331008 R | 341311 | 910018 SM5403 | 910102 SM5401 |
| 1.7 CTDi (EP4) | 4.02 - | | | 741060 | | | 331011 L 331010 R | 341311 | 910018 SM5403 | 910102 SM5401 |
| 2.0 Type-R (EP3) | 01 - | | | 741060 | | | 331011 L 331010 R | 341311 | 910018 SM5403 | 910103 SM5401 |
| 1.4 i 1.6 i (EU5/7) (EU6/8) | 4.01 - | | 731004 L▼ 731003 R▼ | 741060 | | | 331009 L 331008 R | 341311 | 910018 SM5403 | 910102 SM5401 |
| 1.7 CTDi 2.0 i Sport (EU9) (EV1) | 4.02 - 9.03 - | | | 741060 | | | 331011 L 331010 R | 341311 | 910018 SM5403 | 910102 SM5401 |
| 1.4 i 1.6 i (ES4) (ES5) | 4.01 - 12.02 | | 731004 L▼ 731003 R▼ | 741060 | | | 331009 L 331008 R | 341311 | 910018 SM5403 ¹⁾ SM5402 ²⁾ | 910102 SM5400 |
| 1.4 i (ES4) | 1.03 - | | 731004 L▼ 731003 R▼ | 741060 | | | 331009 L 331008 R | 341311 | 910018 SM5402 | 910102 SM5400 |

1) → 02

2) 02 →

CR-V

| | | | | | | | | | | |
|------------------------|------------|--------------|--------|--------|--|--|--------|--------|--------|--------|
| CR-V I 2.0, 2.0 16V | (RD1, RD3) | 10.95 - 2.02 | 741065 | 741066 | | | 341260 | 341261 | SM5058 | SM5058 |
|------------------------|------------|--------------|--------|--------|--|--|--------|--------|--------|--------|

HR-V

| | | | | | | | | | | |
|-----------------|------|--|------------------------|---------|--|--|----------------------|----------------------|--------|--|
| 1.6 16V (GH) | 00 - | | 734041 L▼ 734040 R▼ | 743042▼ | | | 334244 L 334243 R | 343316 ¹⁾ | 910070 | |
| 1.6 16V (GH) | 00 - | | 734041 L▼ 734040 R▼ | 743042▼ | | | 334244 L 334243 R | 343316 ¹⁾ | 910070 | |

1) 343316 : OE p/n = 52610-S2J-951, 52610-S2H-951

Hyundai (KO)

Accent

| | | | | | | | | | | |
|---|------|--------------|--|--|----------------------|--|----------------------|----------------------|------------------|------------------|
| Accent II ALL Incl. Sport sus., ABS | (LC) | 9.99 - 12.06 | | | 323053 L 323052 R | | 333305 L 333304 R | 332109 L 332108 R | 910021 SM5201 | 910062 SM5148 |
|---|------|--------------|--|--|----------------------|--|----------------------|----------------------|------------------|------------------|

| MODEL FAHRZEUG MODELE | YEAR JAHR ANNEE | FRONT | REAR | FRONT | REAR | FRONT | REAR | FRONT | REAR | |
|--|-----------------------|---------|------|--------|--------|--------------------------------|-------------------|--|-------------------|--|
| | | | | | | PROTECTION KIT MOUNTING KIT | | | | |
| Lada (VAZ) (RUS) | | | | | | | | | | |
| 110 / 111 / 112 | | | | | | | | | | |
| | 1.95 - | | | 375038 | 351021 | 365507 | 341824 | SM3201 ¹⁾ ▼ | | |
| 1) Exc. 1500 16V (67kW) (110/111), 1600 (110/111/112), 2000 (110), Wankel (110) | | | | | | | | | | |
| Niva | | | | | | | | | | |
| | (2121-) | 78 - | 11 | | | 243015 | 243016 | 343097 553121▼ | 343098 553005▼ | |
| Exc. 21214M, 4x4M | | | | | | | | | | |
| Samara, Riva, Diva, Forma, Sagona | | | | | | | | | | |
| 1100, 1300, 1500 (2108, 2109, 21099) | 86 - | | | 375037 | 351021 | 365057 | 341824 | 913147 SM3200 ¹⁾ | | |
| (2113, 2114, 2115) | | | | | | | | | | |
| 1) → 99 | | | | | | | | | | |
| VAZ, Nova, Toscana | | | | | | | | | | |
| 1200, 1300, 1500, 1600 (2101, 2102, 2103, 2104, 2105, 2106 2107, 21011, 21061) | 70 - | | | 243015 | 243016 | 343097 553121▼ | 343098 553005▼ | | | |
| Lancia (I) | | | | | | | | | | |
| Dedra (835) | | | | | | | | | | |
| | | | | 324848 | | 334848 | 344115 554077 | 916002▼ 910086▼ SM1802 L▼ SM1803 R▼ | | |
| 1.6 (835AA, AB, AN, BA) | 3.89 - 6.94 | | | | | | | | | |
| 1.8 (835AC, AD, BC, AT, BD, CD) | 3.89 - 6.94 | | | | | | | | | |
| 2.0 (835AI, AL) | 3.89 - 6.94 | | | | | | | | | |
| 1.9 TD (835AG, AS) | 3.89 - 6.94 | | | | | | | | | |
| 2.0 Turbo (835AO, AP, AQ, AR) | 12.90 - 6.94 | | | | | | | | | |
| Exc. | | | | | | | | | | |
| | (835) | 12.90 - | 6.94 | 324848 | | 334848 | 554077 | 916002▼ 910086▼ SM1802 L▼ SM1803 R▼ | | |
| 2.0 Turbo Integrale Exc. | | | | | | | | | | |
| | | | | 324848 | | 334848 | 344115 554077 | 916002▼ 910086▼ SM1802 L▼ SM1803 R▼ | | |
| 1.6 (835EB, EI) | 7.94 - 9.99 | | | | | | | | | |
| 1.8 (835FA, FG) | 7.94 - 9.99 | | | | | | | | | |
| 2.0 (835ED) | 7.94 - 9.99 | | | | | | | | | |
| 1.9 TD (835EE) | 7.94 - 9.99 | | | | | | | | | |
| Exc. | | | | | | | | | | |
| | | | | 324848 | | 334848 | 344115 554077 | 916002▼ 910086▼ SM1802 L▼ SM1803 R▼ | | |
| 1.8 (835EH) | 3.96 - 12.97 | | | | | | | | | |
| 1.9 TD (835EF) | 7.94 - 12.97 | | | | | | | | | |
| Exc. | | | | | | | | | | |
| Dedra (835) | | | | | | | | | | |
| | | | | 324848 | | 334848 | 344115 554077 | 916002▼ 910086▼ SM1802 L▼ SM1803 R▼ | | |
| 1.6 (835EB, EI) | 9.94 - 9.99 | | | | | | | | | |
| 1.8 (835FA, FG) | 9.94 - 9.99 | | | | | | | | | |
| 2.0 (835ED) | 9.94 - 9.99 | | | | | | | | | |
| 1.9 TD (835EE, EF) | 9.94 - 9.99 | | | | | | | | | |
| Exc. | | | | | | | | | | |

| MODEL FAHRZEUG MODELE | YEAR JAHR ANNEE | FRONT | REAR | FRONT | REAR | FRONT | REAR | FRONT | REAR | |
|---|-----------------------|--------------------------|----------------------|--------|------------------------|----------------------|------|--------------------------------|----------------------|--|
| | | | | | | | | PROTECTION KIT MOUNTING KIT | | |
| Lancia (I) | | | | | | | | | | |
| Dedra (835) | | | | | | | | | | |
| 1.8 Exc. | (835EH) | 3.96 - 12.97 | | | 324848 | | | 334848 | 344115 554077 | 916002▼ 910086▼ SM1802 L▼ SM1803 R▼ |
| 2.0 Integrale | (835ED) | 9.94 - 9.99 | | | 324848 | | | 334848 | 344115 554077 | 916002▼ 910086▼ SM1802 L▼ SM1803 R▼ |
| Delta | | | | | | | | | | |
| 1.4, 1.6, 1.8, 2.0 16V Exc. 1.9 TD, 2.0 HF Turbo | (836) | 9.93 - 99 | | | 324848 | | | 334848 | 344115 554077 | 916002▼ 910086▼ SM1802 L▼ SM1803 R▼ |
| Y | | | | | | | | | | |
| 1.2 Elefantino Rosso | (840) | 95 - 9.03 | | | 324805 | 244039▼ | | 334805 | 554086 | SM1805 |
| Lexus (J) | | | | | | | | | | |
| RX | | | | | | | | | | |
| RX300 (ACU/MCU/SXU15) | | 12.97 - 2.03 | | | 324041 L▼ 324040 R▼ | 324043 L 324042 R | | 334262 L 334261 R | 334264 L 334263 R | SM5175 |
| Mazda (J) | | | | | | | | | | |
| MX-5 | | | | | | | | | | |
| 1600, 1900 Incl. ABS | (NA) | 9.89 - 98 | 741015 ¹⁾ | 741016 | | | | 341143 | 341127 | SM5077 SM5077 |
| 1.6 16V, 1.8, 1.8 16V, 1.9 16V Incl. ABS, Sport sus. Exc. Limited edition | (NB) | 1.98 - 12.05 | 741035 | 741036 | | | | 341253 | 341254 | SM5139 SM5139 |
| 1) Exc. ABS | | | | | | | | | | |
| Mercedes Benz (D) | | | | | | | | | | |
| 190 Series (W201) | | | | | | | | | | |
| 190, 190E, 190D Exc. 190E 2.3 16V, 2.5 16V, Sport sus. | (W201) | 12.82 - 93 | | | 324007▼ | 243032 | | 334017 | 553177 | 915124 SM1100 |
| 190E 2.3 16V 190E 2.5 16V | (W201) | 9.83 - 89 9.88 - 5.93 | | | 324007▼ | | | | OE = | 915124 SM1100 |
| Exc. 190E 2.3 16V, 2.5 16V | (W201) | 12.82 - 93 | | | 324007▼ | 243032 | | | | 915124 SM1100 |
| E-Class (124) | | | | | | | | | | |
| 200, 200E, 230E, 260E, 300E, 320E 400E, 200D, 250D, 250 Turbo D 300D, 300D-Turbo Exc. 4-Matic (), Sport sus. | (W124) | 85 - 93 | | | 324007▼ | 243032 Exc. | | 334017 | 553178 Exc. | 915124 SM1101 |

| MODEL FAHRZEUG MODELE | YEAR JAHR ANNEE | FRONT | REAR | FRONT | REAR | FRONT | REAR | FRONT | REAR |
|-----------------------------|-----------------------|-------|------|-------|------|-------|------|--------------------------------|------|
| | | | | | | | | PROTECTION KIT MOUNTING KIT | |

Mercedes Benz (D)

E-Class (124)

| | | | | | | | | | |
|---|---------|--|--|---------|----------------|--------|----------------|------------------|--|
| (C124) 230CE, 300CE, 320CE Exc. Sport sus. | 87 - 93 | | | 324007▼ | 243032 Exc. | 334017 | 553178 Exc. | 915124 SM1101 | |
| (S124) 200T, 230TE, 280TE, 300TE, 320TE 200TD, 250TD, 300TD-Turbo Exc. Sport sus., 4-Matic () | 85 - 93 | | | 324007▼ | | 334017 | OE = | 915124 SM1101 | |
| (W124) 200, 220, 280, 320, 420 200D, 250D, 250D-Turbo, 300D 300D-Turbo Exc. 4-Matic () , Sport sus. | 93 - 95 | | | 324007▼ | 243032 Exc. | 334017 | 553178 Exc. | 915124 SM1101 | |
| (C124) 220C, 320C Exc. Sport sus. | 93 - 95 | | | 324007▼ | 243032 Exc. | 334017 | 553178 Exc. | 915124 SM1101 | |
| (S124) 200T, 220T, 280T, 320T 250TD, 300TD, 300TD-Turbo Exc. Sport sus., 4-Matic () | 93 - 95 | | | 324007▼ | | 334017 | OE = | 915124 SM1101 | |
| (W124, C124) Sport sus. Exc. 4-Matic () , AMG | 85 - 95 | | | 324007▼ | 243032 Exc. | | | 915124 SM1101 | |
| (S124) Sport sus. Exc. 4-Matic () , AMG | 85 - 95 | | | 324007▼ | | | OE = | 915124 SM1101 | |

Mitsubishi (J)

Colt V

| | | | | | | | | | |
|---|-----------|--|---------|--|--|----------------------|--------|--------|--------|
| (CJ1, CJ2, CJ4) 1300, 1500, 1600 Exc. | 96 - 3.97 | | 741033▼ | | | 333225 L 333224 R | 341140 | SM5311 | 910331 |
|---|-----------|--|---------|--|--|----------------------|--------|--------|--------|

FTO

| | | | | | | | | | |
|----------------|---------|--|---------|--|--|----------------------|--------|--|--|
| (DE 2A, DE 3A) | 94 - 97 | | 741033▼ | | | 334391 L 334390 R | 341140 | | |
|----------------|---------|--|---------|--|--|----------------------|--------|--|--|

Galant, Sapporo (Lambda), Sigma

| | | | | | | | | | |
|--|---------------|--|--|--------|--------|--------|--------|--------|--------|
| (EA2A, EA5A, EA6A) 2000, 2500, 2000 Turbo Diesel 2.4 GDi Incl. H/D, | 10.96 - 10.04 | | | 351029 | 351030 | 341141 | 341213 | SM5091 | SM5091 |
|--|---------------|--|--|--------|--------|--------|--------|--------|--------|

Nissan (J)

Almera (N16E)

| | | | | | | | | | |
|--|--------|--|--|----------------------|--------|----------------------|--------|------------------|------------------|
| (N16E) 1.5, 1.8, 2.2 Di 1.5 dCi, 2.2 dCi | 8.00 - | | | 323062 L 323061 R | 351028 | 333311 L 333310 R | 341282 | 910033 SM5216 | 910037 SM9808 |
|--|--------|--|--|----------------------|--------|----------------------|--------|------------------|------------------|

| MODEL FAHRZEUG MODELE | YEAR JAHR ANNEE | FRONT | REAR | FRONT | REAR | FRONT | REAR | FRONT | REAR | |
|--|--|--------------------------|----------|----------------------|----------|--------------------------------|----------------------|------------------------------|------------------------------|--|
| | | | | | | PROTECTION KIT MOUNTING KIT | | | | |
| Nissan (J) | | | | | | | | | | |
| Almera (N16) | | | | | | | | | | |
| 1.5, 1.8, 2.2 Di 1.5 dCi, 2.2 dCi | (N16) 3.01 - | | | 323062 L 323061 R | 351028 | 333311 L 333310 R | 341282 | 910033 SM5216 | 910037 SM9808 | |
| Pick-up, Cab, King Cab, Navara, NP300 | | | | | | | | | | |
| | (MD21) 9.85 - 2.98 | | | 243024 ▼ | | 553152 | 553153 | | | |
| Primera | | | | | | | | | | |
| 2000 (1.6 = 1.8) Incl. ABS | (P10) 6.90 - 96 | | | 351013 | | 341120 | 334057 L 334056 R | 916803 SM5123 | 916806 ▼ SM5204 ▼ | |
| 1.6, 1.8, 2.0, 2.0 Diesel Turbo Exc. 2.0 SRI, 2.0 GTI | (P11) 6.96 - 01 | 741048 ▼ | 741055 ▼ | | | 341120 | 341227 | 916803 SM5123 | 910037 | |
| 2.0 16V SRI 2.0 16V GTI | (P11) 6.96 - 01 | 741048 ▼ | 741055 ▼ | | | 341120 | 341228 | 916803 SM5123 | 910037 | |
| Primera Traveller | | | | | | | | | | |
| 1.6 16V 1.8 16V 2.0 16V 2.0 Diesel Turbo 2.0 SRI | (WP 11) 1.98 - 01 | 741048 ▼ | 741055 ▼ | | | 341120 | 341228 | 916803 SM5123 | 910037 | |
| Silvia, 200 SX | | | | | | | | | | |
| 1.8 16V Turbo | (S13) 9.88 - 94 | | 741017 ▼ | | | 331005 L 331003 R | 341099 | SM5101 | SM5123 | |
| 2.0 16V Turbo | (S14) 94 - 00 | | 741045 | | | 334185 L 334184 R | 341222 | SM5153 | | |
| X-Trail (T30) | | | | | | | | | | |
| | (T30) 7.01 - 5.07 | 734049 L ▼ 734048 R ▼ | | | | 334361 L 334360 R | 334363 L 334362 R | 910034 ▼ 910351 SM5409 | 910038 ▼ 910354 SM9919 | |
| Opel (D) | | | | | | | | | | |
| Ascona, Manta | | | | | | | | | | |
| Ascona, L, SR, Voyage Manta, L, SR, GT Manta E Manta CC/CCE/GTE | 8.75 - 6.81 8.75 - 88 9.77 - 88 8.78 - 88 | | | 244029 | 244030 ▼ | 343048 ▼ | 343006 | | | |
| Astra Exc. OPC / | | | | | | | | | | |
| Astra F Exc. GT, GSi | 9.91 - 1.98 | | | 375034 | 243014 | 365504 | 343047 553075 ▼ | 910160 ▼ SM1303 | | |
| Astra F GT, GSi | 9.91 - 1.98 | | | 375034 | 243014 | 365504 | 343047 553075 ▼ | 910160 ▼ SM1303 | | |

| MODEL FAHRZEUG MODELE | YEAR JAHR ANNEE | FRONT | REAR | FRONT | REAR | FRONT | REAR | FRONT | REAR |
|-----------------------------|-----------------------|-------|------|-------|------|-------|------|--------------------------------|------|
| | | | | | | | | PROTECTION KIT MOUNTING KIT | |

Opel (D)

Calibra

| | | | | | | | | | |
|--|---------|--|--|--------|----------|--------|--------|------------------|--|
| 2.0 i (2WD) (4WD) Exc. 16 V, 16 V Turbo | 90 - 98 | | | 375032 | 353011 ▼ | 365503 | 343259 | 910083 SM1301 | |
| 2.0 i 16V (2WD) (4WD) 2.5 i V6 (2WD) | 90 - 98 | | | 375032 | 353011 ▼ | 365503 | 343259 | 910083 SM1301 | |
| 2.0 i 16V Turbo (4WD) | 90 - 98 | | | 375032 | 353011 ▼ | 365503 | 343259 | 910083 SM1301 | |

Corsa A, Corsa B

| | | | | | | | | | |
|--|-------------|--|--|--------|--------|--------|--------------------|------------------|--|
| Exc. 1.6 GSi | 83 - 2.93 | | | 323034 | 353012 | 333831 | 343265 553155 ▼ | 910083 SM1305 | |
| 1.6 GSi | 88 - 2.93 | | | 323034 | 353012 | 333831 | 343265 553155 ▼ | 910083 SM1305 | |
| Exc. Sport, GSi | 3.93 - 9.00 | | | 323034 | 353012 | 333831 | 343265 553155 ▼ | 910083 SM2302 | |
| 1.4 i Sport, 1.4 Si Sport, 1.5 TD Sport 1.6 i 16V GSi | 3.93 - 9.00 | | | 323034 | 353012 | 333831 | 343265 553155 ▼ | 910083 SM2302 | |

Kadett, Olympia, Aero

| | | | | | | | | | |
|---------------------------------|--------------------|----------|--|--------|----------|----------|--------------------|--|--|
| Kadett C, SR Aero | 73 - 79 76 - 79 | | | 244029 | 244030 ▼ | 343048 ▼ | 343006 | | |
| Kadett D 1.2, 1.3, 1.3 S, SR | 79 - 8.84 | 765021 ▼ | | 375009 | 243014 | 365501 | 343047 553075 ▼ | 915322 ▼ 910083 | |
| Kadett D | 79 - 8.84 | | | 375009 | | 365501 | 343099 553137 ▼ | 915322 ▼ 910083 | |
| Kadett E | 9.84 - 91 | 765021 ▼ | | 375009 | 243014 | 365501 | 343047 553075 ▼ | 915322 ▼ 910083 SM1300 ¹⁾ ▼ SM1307 ¹⁾ ▼ | |

1)

| Model | KYB |
|--|-----|
| 1.2 / 1.3 / 1.4 / 1.6 | |
| 1.6 / 1.8 / 2.0 / 2.0 GSi / 2.0 GSi 16V 2.0 GSi CAT / 2.0 GSi 16V CAT / Diesel | |

Tigra

| | | | | | | | | | |
|--|-----------|--|--|--------|--------|--------|--------------------|------------------|--|
| | 94 - 1.01 | | | 323034 | 353012 | 333831 | 343265 553155 ▼ | 910083 SM2302 | |
|--|-----------|--|--|--------|--------|--------|--------------------|------------------|--|





































Vectra A

| | | | | | | | | | |
|---|-----------|--|--|--------|----------------|--------|----------------------------|--|--|
| (2WD) 1.4, 1.6 i, 1.8 S, 1.8 i, 2.0 i 1.7 D, 1.7 TD Exc. 2.0 16V | 9.88 - 95 | | | 375032 | 243014 Exc. | 365503 | 343047 553075 ▼ Exc. | 910083 SM1301 ¹⁾ SM1306 ²⁾ ▼ | |
| (2WD) 2000-16V (I = 20XE, C 20XE) P1000001 →, P5000001 → P7000001 → | 93 - 95 | | | 375032 | 243014 Exc. | 365503 | 343047 553075 ▼ Exc. | 910083 SM1301 ¹⁾ SM1306 ²⁾ ▼ | |



1) SM1301 : Exc. GT

2) SM1306 : GT

| MODEL FAHRZEUG MODELE | YEAR JAHR ANNEE | FRONT | REAR | FRONT | REAR | FRONT | REAR | FRONT | REAR |
|--|-----------------------|------------------------|---------|------------------------|----------------|----------------------|---------------------------|--|------|
| | | | | | | | | PROTECTION KIT MOUNTING KIT | |
| Opel (D) | | | | | | | | | |
| Vectra A | | | | | | | | | |
| 2.5 i V6 | 93 - 95 | | | 375032 | 243014 Exc. | 365503 | 343047 553075▼ Exc. | 910083 SM1301 ¹⁾ SM1306 ²⁾ ▼ | |
| 1) SM1301 : Exc. GT | | 2) SM1306 : GT | | | | | | | |
| Peugeot (F) | | | | | | | | | |
| 106 I, 106 II | | | | | | | | | |
| Exc. 1.6 16V | 91 - 96 | 765020 | 741064 | 375036 | 241006 | 365506 | 341101 | 913112 SM1902 ¹⁾ SM1903 ²⁾ | |
| 1.6 16V | 94 - | 765020 | 741064 | 375036 | 241006 | 365506 | 341101 | 913112 SM1902 ¹⁾ SM1903 ²⁾ | |
| 1) → 50265608 | | 2) 50265609 → | | | | | | | |
| 205 | | | | | | | | | |
| XA, XAD Exc. GTi, CTi, Rally, Turbo-Diesel | 83 - | 734030 L▼ 734029 R▼ | 741057▼ | 324013 L 324012 R | 354001 | 333828 | 343229 553138▼ | 913112 MB1901 SM1900 | |
| 1.6 GTi, 1.9 GTi | 2.84 - | 734030 L▼ 734029 R▼ | 741057▼ | 324013 L 324012 R | 354001 | 334023 L 334022 R | 344112 | 913112 MB1901 SM1900 | |
| CT, CJ | 86 - 94 | 734030 L▼ 734029 R▼ | 741057▼ | 324013 L 324012 R | 354001 | 333828 | 343229 553138▼ | 913112 MB1901 SM1900 | |
| 206 | | | | | | | | | |
| 1.1 i 1.4 HDi Exc. , XA, Entrepise | 9.98 - | | 741069 | 323055 L▼ 323054 R▼ | 351025 | 333730 L 333729 R | 341249 | 910041 MB1901 SM1912 L SM1913 R | |
| 1.4 i, 1.4 LPG, 1.6 i, 1.9 D, 2.0 HDI 1.4 HDi 1.6 HDi, 2.0 S16 Exc. , Entrepise | 9.98 - | | 741069 | 323055 L▼ 323054 R▼ | 351025 | 333730 L 333729 R | 341249 | 910041 MB1901 SM1910 L SM1911 R | |
| Entrepise 1.1 i XA, 1.4 i XA, 1.9 D, 1.4 HDi Exc. | 9.98 - | | | 323055 L▼ 323054 R▼ | 351027 | 333730 L 333729 R | 341250 | 910041 MB1901 SM1910 L SM1911 R | |
| 206 CC | | | | | | | | | |
| | 01 - | | | 323055 L▼ 323054 R▼ | 351027 | 333730 L 333729 R | 341250 | 910041 MB1901 SM1910 L SM1911 R | |
| 206 SW | | | | | | | | | |
| | 6.02 - | | | 323055 L▼ 323054 R▼ | 351027 | 333730 L 333729 R | 341250 | 910041 MB1901 SM1910 L SM1911 R | |





| MODEL FAHRZEUG MODELE | YEAR JAHR ANNEE | FRONT | REAR | FRONT | REAR | FRONT | REAR | FRONT | REAR |
|--|----------------------------|---|---------|--|---------|---|-------------------|--|------|
| | |  | |  | |  | | PROTECTION KIT MOUNTING KIT | |
| Peugeot (F) | | | | | | | | | |
| 306  | | | | | | | | | |
|  1.1  1.4 Exc. 175-70-  , 175-65-  | 93 - 2.97 | 733032 L▼ 733031 R▼ | 743034▼ | 323839 L 323838 R | 241008 | 333839 L 333838 R | 341166 | 913112 MB1901 SM1907 ¹⁾ | |
|  1.4  175-70-  , 175-65-  1.6, 1.8, 1.8 D, 1.9 D, 1.9 TD   Exc. 2.0, 2.0 16V | 93 - 2.97 94 - 2.97 | 733032 L▼ 733031 R▼ | 743034▼ | 323839 L 323838 R | 241008 | 333839 L 333838 R | 341166 | 913112 MB1901 SM1907 ¹⁾ | |
|  1.4 Exc. 175-70-  | 3.97 - 01 | 733032 L▼ 733031 R▼ | 743034▼ | 323839 L 323838 R | 241008 | 333839 L 333838 R | 341166 | 913112 MB1901 SM1907 ¹⁾ | |
|  1.4  175-70-  , 175-65-  1.6, 1.8, 1.8 D, 1.9 D, 1.9 TD   Exc. 2.0, 2.0 16V | 4.93 - 5.01 | 733032 L▼ 733031 R▼ | 743034▼ | 323839 L 323838 R | 241008 | 333839 L 333838 R | 341166 | 913112 MB1901 SM1907 ¹⁾ | |
|  2.0, 2.0 16V, 2.0 HDi, 2.0 S16, 2.0 ST, 2.0 XSi | 4.93 - 5.01 | 733032 L▼ 733031 R▼ | 743034▼ | 323839 L 323838 R | 241008 | 333839 L 333838 R | 341166 | 913112 MB1901 SM1907 ¹⁾ | |
|   | 3.94 - 4.02 | 733032 L▼ 733031 R▼ | 743034▼ | 323839 L 323838 R | 241008 | 333839 L 333838 R | 341166 | 913112 MB1901 SM1907 ¹⁾ | |
|   | 6.94 - 4.02 | 733032 L▼ 733031 R▼ | 743034▼ | 323839 L 323838 R | 241008 | 333839 L 333838 R | 341166 | 913112 MB1901 SM1907 ¹⁾ | |
|   | 7.93 - 7.01 | 733032 L▼ 733031 R▼ | 743034▼ | 323839 L 323838 R | 241008 | 333839 L 333838 R | 341166 | 913112 MB1901 SM1907 ¹⁾ | |
| 1)   | | | | | | | | | |
| 309  | | | | | | | | | |
| GT, GT injection, Turbo Diesel 1.9 SR | 85 - 93 | | | 324013 L 324012 R | 354001 | 334023 L 334022 R | 343229 553138▼ | 913112 MB1901 SM1900 | |
| 405  | | | | | | | | | |
|   Exc. MI 16, GRI, SRI,  | 87 - 96 | | | | 351014▼ | 333829 | 341102 551053▼ | 913112 ¹⁾ MB1901 SM1914 ²⁾ ▼ SM1901 ³⁾ SM1904 ⁴⁾ ▼ | |
| 1) → 11.99 2) 87 - 5.88 3) 5.88 - 6.92 4) 7.92 → | | | | | | | | | |

AGX

| MODEL FAHRZEUG MODELE | YEAR JAHR ANNEE | FRONT | REAR | FRONT | REAR | FRONT | REAR | FRONT | REAR |
|-----------------------------|-----------------------|---|------|--|------|---|------|--------------------------------|------|
| | |  | |  | |  | | PROTECTION KIT MOUNTING KIT | |

Peugeot (F)

405  

| | | | | | | | | | |
|--|---------|--|--|--|---------|--------|-------------------|--|--|
|    MI 16, GRI, SRI Exc.  | 87 - 96 | | | | 351014▼ | 333829 | 341102 551053▼ | 913112 ¹⁾ MB1901 SM1914 ²⁾ ▼ SM1901 ³⁾ SM1904 ⁴⁾ ▼ | |
|--|---------|--|--|--|---------|--------|-------------------|--|--|

1) → 11.99 2) 87 - 5.88 3) 5.88 - 6.92 4) 7.92 →

Renault (F)

Clio I  (375*, 557*, 657*, B57*, C57*, S57*)

| | | | | | | | | | |
|--|-----------|--|--|----------------------|--------|--|-------------------|--|--|
| 1.2 1.4 | 90 - 7.97 | | | 323825 ¹⁾ | 241009 | 333824 ¹⁾ 333825 ¹⁾ | 341148 551054▼ | 913237 MB1504 SM1504 ²⁾ SM1503 ³⁾ | |
| 1.7, 1.8, 1.9 D Exc. 1.8 RSi, 1.8 16V | 90 - 7.97 | | | 323825 ¹⁾ | 241009 | 333825 ¹⁾ | 341148 551054▼ | 913237 MB1504 SM1503 | |
| 1.8 RSi (357E, 357V, C579, C57H) Exc. 1.8 16V | 90 - 7.97 | | | 323825 ¹⁾ | 241009 | 333825 ¹⁾ | 551054▼ | 913237 MB1504 SM1503 | |
| 1.2 1.4 | 7.97 - 98 | | | | 241009 | 333824 ¹⁾ 333706 ¹⁾ | 341148 551054▼ | 913237 MB1504 SM1504 ²⁾ SM1503 ³⁾ | |
| 1.8, 1.9 D Exc. 1.8 RSi, 1.8 16V | 7.97 - 98 | | | | 241009 | 333706 ¹⁾ | 341148 551054▼ | 913237 MB1504 SM1503 | |
| 1.8 RSi (357V, C57H) Exc. 1.8 16V | 7.97 - 98 | | | | 241009 | 333706 ¹⁾ | 551054▼ | 913237 MB1504 SM1503 | |
| 1.8 16V (C575, C57D) | 90 - 98 | | | 323849 ¹⁾ | 241010 | 333849 ¹⁾ | 551068 | 913237 MB1504 SM1503 | |
| 2.0 16V Williams (C57M) | 90 - 98 | | | | 241010 | | 551068 | MB1504 SM1503 | |

1)

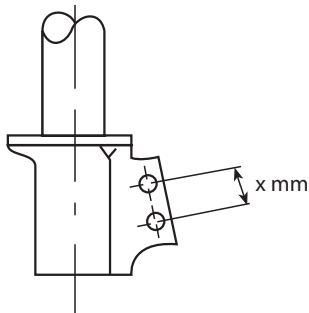

333824 : X = 52 mm
 333825, 323825 : X = 54 mm
 333706, 333849, 323849 : X = 58 mm

2) SM1504 : 1.2L

3) SM1503 : 1.4L

| MODEL FAHRZEUG MODELE | YEAR JAHR ANNEE | FRONT | REAR | FRONT | REAR | FRONT | REAR | FRONT | REAR |
|-----------------------------|-----------------------|-------|------|-------|------|-------|------|--------------------------------|------|
| | | | | | | | | PROTECTION KIT MOUNTING KIT | |

Renault (F)

Mégane I, Mégane Classic

| | | | | | | | | | |
|---------------------------------|-------------------|--|--|----------------------|--------|----------------------|--------|----------------------------|--|
| (BA0/1, LA0/1) Exc. 2.0 16V, | 95 - 03 | | | 323827 | 241011 | 333827 | 551804 | 945502 MB1901 SM1515 | |
| 2.0 16V Exc. | (BA0/1) 95 - 9.98 | | | 324808 ¹⁾ | 241012 | 334808 ¹⁾ | 551820 | MB1901 | |

Mégane I, Mégane Coach

| | | | | | | | | | |
|--------------------------------|--------------------------|--|--|----------------------|--------|----------------------|--------|----------------------------|--|
| (DA0/1, EA0/1) Exc. 2.0 16V | 96 - 03 | | | 323827 | 241012 | 333827 | 551819 | 945502 MB1901 SM1515 | |
| 2.0 16V | (DA0/1, EA0/1) 96 - 9.98 | | | 324808 ¹⁾ | 241012 | 334808 ¹⁾ | 551820 | MB1901 | |

1) 334808, 324808 : x = 60 mm

Mégane I Grandtour

| | | | | | | | | | |
|-----------------|-------------|--|--|--------|--|--------|--------|----------------------------|--|
| (KA0/1) Exc. | 3.99 - 8.03 | | | 323827 | | 333827 | 555800 | 945502 MB1901 SM1515 | |
|-----------------|-------------|--|--|--------|--|--------|--------|----------------------------|--|

R 19 / Chamade

| | | | | | | | | | |
|--------------------|-----------|--|--|--------|--|--------|----------------------|--|--|
| 2x Exc. 1.8 16V | 9.88 - 95 | | | 323808 | | 333808 | 343233 ²⁾ | 945502 MB1901 SM1515 ¹⁾ | |
| 4x Exc. 1.8 16V | 9.88 - 95 | | | 323808 | | 333808 | 343234 ³⁾ | 945502 MB1901 SM1515 | |

1) SM1515 : Exc. B/C/L 532

2) L max. = 524mm

3) L max. = 563mm

| MODEL FAHRZEUG MODELE | YEAR JAHR ANNEE | FRONT | REAR | FRONT | REAR | FRONT | REAR | FRONT | REAR | | | | | | |
|---|-----------------------|-------|------|--|--------|--|--------|--|--|--|------------|----------------------------|--------|---------|--------|
| | | | | | | | | PROTECTION KIT MOUNTING KIT | | | | | | | |
| Renault (F) | | | | | | | | | | | | | | | |
| Twingo | | | | | | | | | | | | | | | |
| 1.1, 1.2 (C/S 063, 064, 066, 067, 068) (C/S 06C, 06D, 06G, 06K) ⊕ | 10.00 - 8.04 | | | 328701 L 328700 R | 351702 | 333724 L 333723 R | 341813 | 913237 MB1504 SM1504 | 915501 SM9500 | | | | | | |
| 1.2 16V | 8.04 - | | | 328701 L 328700 R | 351702 | 333724 L 333723 R | 341813 | 913237 MB1504 SM1504 | 915501 SM9500 | | | | | | |
| Seat (E) | | | | | | | | | | | | | | | |
| Alhambra | | | | | | | | | | | | | | | |
| (710) Incl. Sport sus. | 6.10 - | | | 325700 | 354006 | 335808 | 344459 | 910004 ¹⁾ 910059 ²⁾ | 910056 SM9709 | | | | | | |
| 1) Exc. Sport sus. 2) ⊕ Sport sus. | | | | | | | | | | | | | | | |
| Altea, Altea XL | | | | | | | | | | | | | | | |
| (5P) Exc. Sport sus., | 3.04 - | | | 324703 ¹⁾ 325700 ²⁾ | 354006 | 334834 ¹⁾ 335808 ²⁾ | 344459 | 910057 SM1714 | 910058 SM9707 | | | | | | |
| <p>1) </p> <p>2) </p> | | | | | | | | | | | | | | | |
| Arosa | | | | | | | | | | | | | | | |
| 1.0, 1.4, 1.7 SDI, 1.4 TDi Exc. Sport sus. | (6H) 97 - 6.04 | | | 324025 | | 333712 | 343309 | 915401 SM1707 | 910280 ¹⁾ 910281 ¹⁾ SM9939 | | | | | | |
| <p>1) <table border="1" style="display: inline-table; vertical-align: middle;"> <tr> <td></td> <td>KYB</td> </tr> <tr> <td>1.0, 1.4, 1.4 TDi, 1.7 SDi</td> <td> 910280</td> </tr> <tr> <td>1.4 16V</td> <td> 910281</td> </tr> </table> </p> | | | | | | | | | | | KYB | 1.0, 1.4, 1.4 TDi, 1.7 SDi | 910280 | 1.4 16V | 910281 |
| | KYB | | | | | | | | | | | | | | |
| 1.0, 1.4, 1.4 TDi, 1.7 SDi | 910280 | | | | | | | | | | | | | | |
| 1.4 16V | 910281 | | | | | | | | | | | | | | |

| MODEL FAHRZEUG MODELE | YEAR JAHR ANNEE | FRONT | REAR | FRONT | REAR | FRONT | REAR | FRONT | REAR |
|-----------------------------|-----------------------|-------|------|-------|------|-------|------|-------|------|
| | | | | | | | | | |

Seat (E)

Ibiza, Cordoba Exc. Cupra

| | | | | | | | | | | |
|---|------------|--------------|---------|--|--------|----------------------|--------|--------------------------------|---|--|
| 1.0, 1.0 i, 1.3, 1.4 1.9 SDI | (6K, 6K/C) | 93 - 8.99 | 734039▼ | | 324025 | 353021 ¹⁾ | 333712 | 343274 ¹⁾ | 915401 SM1701▼ SM1700 ³⁾ SM1704 ³⁾ | 915419 SM9700 |
| 1.6, 1.8 1.9 D, 1.9 TD (47 kW, 55 kW) Exc. 1.8 16V, 1.9 TDI | (6K, 6K/C) | 93 - 8.99 | 734039▼ | | 324025 | 353021 ¹⁾ | 333712 | 343274 ¹⁾ | 915401 SM1701▼ SM1700 ³⁾ SM1704 ³⁾ | 915419 SM9700 |
| 1.9 TDI (66 kW, 81 kW) | (6K, 6K/C) | 96 - 8.99 | 734039▼ | | 324025 | 353021 ¹⁾ | 334810 | 343274 ¹⁾ | 910088 SM1701▼ SM1700 ³⁾ SM1704 ³⁾ | 915419 SM9700 |
| 1.8 16V 2.0 GTi, 2.0 GTi 16V, 2.0 SX 16V | (6K, 6K/C) | 93 - 8.99 | | | 324025 | | 334810 | 343283 ¹⁾ ▼ | 910088 SM1701▼ SM1700 ³⁾ SM1704 ³⁾ | 915419 SM9700 |
| 1.0, 1.4, 1.6, 1.9 D Exc. Sport sus. | (6K, 6K/C) | 8.99 - 2.02 | | | 324025 | | 333712 | 343297 ¹⁾ | SM1713 | 915419 SM9700 |
| 1.8, 1.9 TD | (6K, 6K/C) | 8.99 - 2.02 | | | 324025 | | 334810 | 343297 ¹⁾ | SM1713 | 915419 SM9700 |
| ⊕ Sport sus. | (6K, 6K/C) | 8.99 - 2.02 | | | 324025 | | 334810 | 343297 ¹⁾ | SM1713 | 915419 SM9700 |
| Exc. Sport sus. | (6L) | 3.02 - 11.09 | | | 324702 | 353025 | 334835 | 343328 552700 ²⁾ | 910084 SM1713 | 915400 SM9703 ⁴⁾ SM9704 ⁵⁾ |

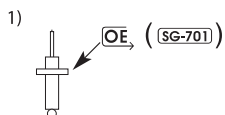

- 2) ⊕ Cordoba (6L2) : 1.2 (47 kW), 1.4 TDI (51 kW, 55 kW), 1.6 ⊕ Sport sus., 1.9 SDI
⊕ Ibiza IV (6L1) : 1.2 (44 kW), 1.6 16V, 1.9 SDI

3)

| Model | | Year | KYB |
|---------|-------------|-------------------|--------|
| Cordoba | 1.4 i | ABD 11.93 - 10.95 | SM1700 |
| | | AEX 9.95 - 6.96 | SM1704 |
| | | ABD 10.95 - 11.95 | SM1700 |
| | 1.6 i | ABU 9.93 - 8.94 | SM1700 |
| | | 1F 11.93 - 10.95 | SM1700 |
| | | AFT 9.95 - 6.96 | SM1704 |
| | | 1F 10.95 - 6.96 | SM1704 |
| | 1.8 i | ABS 9.93 - 8.94 | SM1700 |
| | | ADL 2.94 - 6.96 | SM1704 |
| | | ADL 2.94 - 3.94 | SM1700 |
| | | ADZ 7.94 - 10.95 | SM1700 |
| | | ACC 3.95 - 10.95 | SM1700 |
| | | ACC 10.95 - 6.96 | SM1704 |
| | 1.9 D | 9.93 - 10.95 | SM1700 |
| | | 10.95 - 6.96 | SM1704 |
| | 1.9 SDI | 9.95 - 6.96 | SM1704 |
| | 1.9 TD | 9.93 - 10.95 | SM1700 |
| | | 9.93 - 2.94 | SM1700 |
| | 2.0 i | 2.94 - 6.96 | SM1704 |
| | | 7.96 - 8.99 | SM1704 |
| | 8.99 - 2.02 | SM1713 | |
| | 3.02 - | SM1713 | |

| Model | | Year | KYB |
|----------------|---------|--------------|--------|
| Ibiza | 1.05 i | 2.93 - 10.95 | SM1700 |
| | | 10.95 - 6.96 | SM1704 |
| 1.3 i | 1.6 i | 2.93 - 7.94 | SM1700 |
| | | 2.93 - 10.95 | SM1700 |
| 1.9 D / 1.9 TD | 1.4 i | 10.95 - 6.96 | SM1704 |
| | | 2.93 - 10.95 | SM1700 |
| 1.4 i | 1.8 i | 10.95 - 6.96 | SM1704 |
| | | 2.93 - 10.95 | SM1700 |
| 1.8 i | 1.9 SDI | 7.95 - 6.96 | SM1704 |
| | | 10.95 - 6.96 | SM1704 |
| 1.8 i | 2.0 i | 2.93 - 10.95 | SM1700 |
| | | 2.94 - 6.96 | SM1704 |
| 1.8 i | | 2.94 - 6.96 | SM1704 |
| | | 7.94 - 3.95 | SM1704 |
| 1.8 i | 2.0 i | 7.94 - 10.95 | SM1700 |
| | | 10.95 - 6.96 | SM1704 |
| 1.9 SDI | 2.0 i | 10.95 - 6.96 | SM1704 |
| | | 9.95 - 6.96 | SM1704 |
| 2.0 i | | 9.93 - 2.94 | SM1700 |
| | | 2.94 - 6.96 | SM1704 |
| | 3.02 - | 7.96 - 8.99 | SM1704 |
| | | 8.99 - 2.02 | SM1713 |
| | 3.02 - | 3.02 - | SM1713 |

4) SM9703 : OE p/n = 1J0513353D

5) SM9704 : OE p/n = 1J0513353G, 1J0513353B, 6R0513353

| MODEL FAHRZEUG MODELE | YEAR JAHR ANNEE | FRONT | REAR | FRONT | REAR | FRONT | REAR | FRONT | REAR | PROTECTION KIT MOUNTING KIT |
|--|---|---------------------------------|---------|--|----------------------|--|----------------------|---|--|--------------------------------|
| | | | | | | | | | | |
| Seat (E) | | | | | | | | | | |
| Cordoba Vario | | | | | | | | | | |
| 1.4, 1.6 1.9 SDI (47 kW, 50 kW) | (6K) 97 - 8.02 | | | 324025 | | 333712 | 343297 ¹⁾ | 915401 SM1704 ²⁾ SM1713 ³⁾ | 915419 SM9700 | |
| 1.9 TDI (66 kW, 81 kW) | (6K) 97 - 8.02 | | | 324025 | | 334810 | 343297 ¹⁾ | 910088 SM1704 ²⁾ SM1713 ³⁾ | 915419 SM9700 | |
| 1) | 2) 97 - 5.99 | | | | | | | | | |
| | 3) 6.99 - 8.02 | | | | | | | | | |
| Leon (1M1) | | | | | | | | | | |
| 1.4, 1.6 Exc. Sport sus., Cupra | (1M1) 10.99 - 9.05 | 734033 | 743029 | 324016 | 243037 | 333713 | 343348 553206 | 915415 SM1708 | 915400 SM9703 ¹⁾ SM9704 ²⁾ | |
| 1.8, 1.8T, 1.9 SDi, 1.9 TDi Exc. Sport sus., Cupra | (1M1) 10.99 - 9.05 | 734033 | 743029 | 324016 | 243037 | 334812 | 343348 553206 | 915415 SM1708 | 915400 SM9703 ¹⁾ SM9704 ²⁾ | |
| ⊕ Sport sus. Exc. Cupra | (1M1) 10.99 - 9.05 | 734033 | 743029 | 324016 | 243037 | 334812 | 553206 | 915415 SM1708 | 915400 SM9703 ¹⁾ SM9704 ²⁾ | |
| 1) SM9703 : OE p/n = 1J0513353D | | 2) SM9704 : OE p/n = 1J0513353G | | | | | | | | |
| Leon (1P1) | | | | | | | | | | |
| Exc. Sport sus. | (1P1) 5.05 - | | | 324703 ¹⁾ 325700 ²⁾ | 354006 | 334834 ¹⁾ 335808 ²⁾ | 344459 | 910059 SM1714 | 910058 SM9707 | |
| 1) | | | | | | | | | | |
| 2) | | | | | | | | | | |
| Toledo I (1L) | | | | | | | | | | |
| 1.6, 1.8, 2.0 1.9 D, 1.9 TD (kW : 47, 50, 55) Exc. 1.8 i 16V, 2.0 i 16V, 1.9 TDI | (1L) 91 - 99 | 734039▼ | 741062▼ | 324025 | 353013 ¹⁾ | 333712 | 343191 ¹⁾ | 915401 SM1701▼ SM1700 ²⁾ SM1704 ²⁾ | 910087 SM9700 | |
| 1.9 TDI (66 kW, 81 kW) | (1L) 95 - 99 | 734039▼ | 741062▼ | 324025 | 353013 ¹⁾ | 334810 | 343191 ¹⁾ | 910088 SM1701▼ SM1700 ²⁾ SM1704 ²⁾ | 910087 SM9700 | |
| 1.8i 16V GT 2.0 i 16V, 2.0 i 16V GT | (1L) 91 - 99 | 734039▼ | 741062▼ | 324025 | 353013 ¹⁾ | 334810 | 343191 ¹⁾ | 915401 SM1701▼ SM1700 ²⁾ SM1704 ²⁾ | 910087 SM9700 | |
| 1) | 2) SM1700: 91 - → ZR-054 453 SM1704: ZR-054 454 → - 99 | | | | | | | | | |

| MODEL FAHRZEUG MODELE | YEAR JAHR ANNEE | FRONT | REAR | FRONT | REAR | FRONT | REAR | FRONT | REAR |
|-----------------------------|-----------------------|-------|------|-------|------|-------|------|--------------------------------|------|
| | | | | | | | | PROTECTION KIT MOUNTING KIT | |

Seat (E)

Toledo II (1M2)

| | | | | | | | | | | |
|---|-------|-----------|--------|--------|--------|--------|--------|------------------|------------------|--|
| 1.4 16V, 1.6, 1.9 SDI Exc. Sport sus., | (1M2) | 99 - 7.04 | 734033 | 743029 | 324016 | 243037 | 333713 | 343348 553206 | 915415 SM1708 | 915400 SM9703 ¹⁾ SM9704 ²⁾ |
| 1.8 20V, 2.3 V5, 1.9 TDI Exc. Sport sus., | (1M2) | 99 - 7.04 | 734033 | 743029 | 324016 | 243037 | 334812 | 343348 553206 | 915415 SM1708 | 915400 SM9703 ¹⁾ SM9704 ²⁾ |
| 1.6, 1.8 20V, 2.3 V5, 1.9 TDI ⊕ Sport sus. | (1M2) | 99 - 7.04 | 734033 | 743029 | 324016 | 243037 | 334812 | 553206 | 915415 SM1708 | 915400 SM9703 ¹⁾ SM9704 ²⁾ |

1) SM9703 : OE p/n = 1J0513353D 2) SM9704 : OE p/n = 1J0513353G

Toledo III (5P2)

| | | | | | | | | | | |
|------------------|-------|-------------|--|--|--|--------|--|--------|------------------|------------------|
| Exc. Sport sus., | (5P2) | 4.04 - 5.09 | | | 324703 ¹⁾ 325700 ²⁾ | 354006 | 334834 ¹⁾ 335808 ²⁾ | 344459 | 910057 SM1714 | 910058 SM9707 |
|------------------|-------|-------------|--|--|--|--------|--|--------|------------------|------------------|

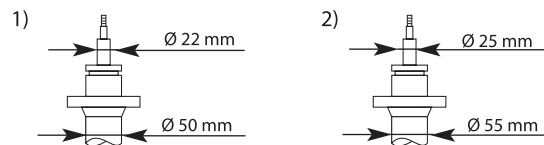

Seat Commercial (E)

Inca

| | | | | | | | | | | |
|--|------|-----------|--|--|--------|--|--------|--------|--------|--|
| 1.0, 1.4, 1.9 D, 1.9 SDI 1.6 i, 1.7 D | (6K) | 96 - 6.03 | | | 324025 | | 333712 | 553231 | SM1704 | |
|--|------|-----------|--|--|--------|--|--------|--------|--------|--|

Skoda (CS)

Fabia

| | | | | | | | | | | |
|--|------|---------------|--|--|--------|--------|--------|------------------|------------------|------------------|
| Fabia I 1.0, 1.2, 1.4, 1.4 16V, 1.4 TDi, 1.9 SDi, 1.9 TDi, 2.0 Exc. , Sport sus. | (6Y) | 8.99 - 12.07 | | | 324702 | 353025 | 334835 | 343328 552700 | 910084 SM1713 | 915400 SM9704 |
| Fabia I 1.0, 1.2, 1.4, 1.4 16V, 1.4 TDi, 1.9 SDi, 1.9 TDi, 2.0 ⊕ Exc. Sport sus. | (6Y) | 8.99 - 12.07 | | | 324702 | | 334835 | 343348 | 910084 SM1713 | 915400 SM9704 |
| Fabia I 1.0, 1.2, 1.4, 1.4 16V, 1.4 TDi, 1.9 SDi, 1.9 TDi, 2.0 ⊕ Sport sus. Exc. | (6Y) | 8.99 - 12.07 | | | 324702 | | 334835 | 343485 | 910084 SM1713 | 915400 SM9704 |
| Fabia II 1.2, 1.2 12V, 1.2 LPG, 1.2 TSi, 1.2 TDi, 1.4, 1.4 LPG, 1.4 TSi, 1.4 TDi, 1.6, 1.6 TDi, 1.9 TDi Exc. , Sport sus., | | 12.06 - 12.14 | | | 324702 | 353025 | 334835 | 343328 552700 | 910084 SM1713 | 915400 SM9704 |

| MODEL FAHRZEUG MODELE | YEAR JAHR ANNEE | FRONT | REAR | FRONT | REAR | FRONT | REAR | FRONT | REAR |
|-----------------------------|-----------------------|-------|------|-------|------|-------|------|--------------------------------|------|
| | | | | | | | | PROTECTION KIT MOUNTING KIT | |

Skoda (CS)

Fabia

| | | | | | | | | | |
|---|---------------|--|--|--------|----------------------|--------|--|------------------|------------------|
| Fabia II 1.2, 1.2 12V, 1.2 LPG, 1.2 TSi, 1.2 TDi, 1.4, 1.4 LPG, 1.4 TSi, 1.4 TDi, 1.6, 1.6 TDi, 1.9 TDi ⊕ Exc. Sport sus., | 12.06 - 12.14 | | | 324702 | | 334835 | 343348 | 910084 SM1713 | 915400 SM9704 |
| Fabia II 1.2, 1.2 12V, 1.2 LPG, 1.2 TSi, 1.2 TDi, 1.4, 1.4 LPG, 1.4 TSi, 1.4 TDi, 1.6, 1.6 TDi, 1.9 TDi ⊕ Sport sus., Exc. | 12.06 - 12.14 | | | 324702 | | 334835 | 343485 | 910084 SM1713 | 915400 SM9704 |
| Fabia III (NJ3, NJ5) ALL Exc. Sport sus. | 8.14 - | | | | 353025 ¹⁾ | 339763 | 343328 ¹⁾ 343348 ²⁾ 552700 ¹⁾ | SM1708 | SM9704 |

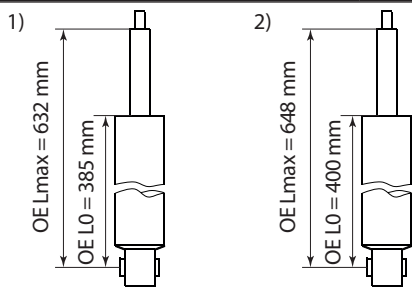

Octavia I (1U2)

| | | | | | | | | | |
|--|--------------|--|--|--------|--------|--------|------------------|------------------|--|
| (1U2) 1.4, 1.4 16V, 1.6, 1.9 SDi Exc. Sport sus., , RS | 9.96 - 12.10 | | | 324016 | 243037 | 333713 | 343348 553206 | 915415 SM1708 | 915400 SM9703 ¹⁾ SM9704 ²⁾ |
| (1U2) 1.8, 1.8 T, 1.9 TDi, 2.0 Exc. Sport sus., , RS | 9.96 - 12.10 | | | 324016 | 243037 | 334812 | 343348 553206 | 915415 SM1708 | 915400 SM9703 ¹⁾ SM9704 ²⁾ |

1) SM9703 : OE p/n = 1J0513353D 2) SM9704 : OE p/n = 1J0513353B

Octavia II (1Z3)

| | | | | | | | | | |
|------------------------------------|-------------|--|--|--|--------|--|--------|--|--|
| ALL (1Z3) Exc. Sport sus., , RS | 2.04 - 2.13 | | | 324703 ¹⁾ 325700 ²⁾ | 354006 | 334834 ¹⁾ 335808 ²⁾ | 344459 | 910059 ³⁾ 910057 ⁴⁾ 910177 ⁵⁾ SM1714 | 910045 ⁶⁾ 910056 ⁷⁾ SM9708 ⁶⁾ SM9709 ⁷⁾ |
|------------------------------------|-------------|--|--|--|--------|--|--------|--|--|

Octavia II Combi (1Z5)

| | | | | | | | | | |
|------------------------------------|-------------|--|--|--|--------|--|--------|--|--|
| ALL (1Z5) Exc. Sport sus., , RS | 2.04 - 2.13 | | | 324703 ¹⁾ 325700 ²⁾ | 354006 | 334834 ¹⁾ 335808 ²⁾ | 344459 | 910059 ³⁾ 910057 ⁴⁾ 910177 ⁵⁾ SM1714 | 910045 ⁶⁾ 910056 ⁷⁾ SM9708 ⁶⁾ SM9709 ⁷⁾ |
|------------------------------------|-------------|--|--|--|--------|--|--------|--|--|

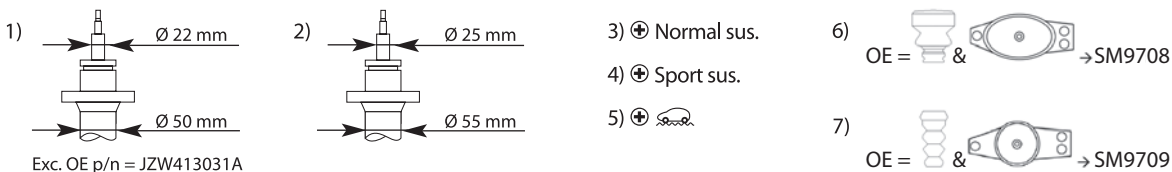

| MODEL FAHRZEUG MODELE | YEAR JAHR ANNEE | FRONT | REAR | FRONT | REAR | FRONT | REAR | FRONT | REAR |
|-----------------------------|-----------------------|-------|------|-------|------|--------------------------------|------|-------|------|
| | | | | | | PROTECTION KIT MOUNTING KIT | | | |

Skoda (CS)

Roomster , Praktik

| | | | | | | | | | |
|--|--------|--|--|--------|--|--------|-------------------|--|------------------|
| 1.2, 1.2TDi, 1.2TSi, 1.4, 1.4TDi (5J) 1.6, 1.6TDi, 1.9TDi | 3.06 - | | | 324702 | | 334835 | 343298 553232▼ | 910084 SM1708 ¹⁾ SM1713 ²⁾ | 910137 SM9703 |
|--|--------|--|--|--------|--|--------|-------------------|--|------------------|

1) → 5J-95032 164
 → 5J-98601 131

2) 5J-95032 165 →
 5J-98601 132 →

Superb II

| | | | | | | | | | |
|--------------------------------|--------|--|--|--------|--|----------------------|----------------------|------------------|--------------------------------|
| (3T4, 3T5) Exc. Sport sus., | 3.08 - | | | 325700 | | 335808 ¹⁾ | 3440030 | 910059 SM1714 | 910056 SM9709 ³⁾ |
| (3T4, 3T5) Exc. Sport sus., | 3.08 - | | | 325700 | | 335808 ¹⁾ | 344459 ²⁾ | 910059 SM1714 | 910056 SM9709 ³⁾ |

1) Exc. Confort Version 2) (4WD) Normal sus. : → 5.10 3) Exc.

Subaru (J)

Forester

| | | | | | | | | | |
|--|-----------|--|--|----------------------|----------------------|----------------------|--|------------------|--------------------------------|
| 2.0 (4WD) (SF5) 2.0 S Turbo (4WD) Exc. | 97 - 5.02 | | | 324053 L 324052 R | 324055 L 324054 R | 334190 L 334189 R | 334192 L ¹⁾ 334191 R ¹⁾ | 910105 SM5361 | 910072 SM8101 L SM8102 R |
|--|-----------|--|--|----------------------|----------------------|----------------------|--|------------------|--------------------------------|

1)

| | (A) | (B) |
|--------------------|-------|---------|
| 334191/334192 | 402mm | Shape N |
| OE = Self Leveling | 408mm | Shape F |

Impreza (GC), (GF)

| | | | | | | | | | |
|---|------------|----------------------|----------------------|--|--|----------------------|----------------------|--------|--------|
| (4WD) (GC/GF8*L8) 2.0 Turbo Exc. STi ver. | 92 - 12.00 | 734007 L 734006 R | 733011 L 733010 R | | | 334256 L 334255 R | 334110 L 334109 R | SM5361 | SM5243 |
|---|------------|----------------------|----------------------|--|--|----------------------|----------------------|--------|--------|

Impreza (GD), (GG)

| | | | | | | | | | |
|---|---------------|----------------------|----------------------|----------------------|----------------------|----------------------|----------------------|------------------|--------------------------------|
| (4WD) (GD) 1.6, 2.0, 2.0 Turbo WRX, 2.5 Exc. WRX-STi | 10.00 - 10.02 | 734035 L 734034 R | 734037 L 734036 R | | | 334305 L 334304 R | 334307 L 334306 R | 910142 SM5361 | 910046 SM8101 L SM8102 R |
| (4WD) (GDB) 2.0 Turbo WRX-STi | 10.00 - 10.02 | | | 321007 L 321006 R | 321009 L 321008 R | | | | SM8101 L SM8102 R |
| (4WD) (GD) 1.6, 2.0, 2.0 Turbo WRX, 2.5 Exc. WRX-STi | 11.02 - 12.02 | | | | 324031 L 324030 R | 334305 L 334304 R | 334359 L 334358 R | 910142 SM5361 | 910046 SM8101 L SM8102 R |
| (4WD) (GDB) 2.0 Turbo WRX-STi | 11.02 - 12.02 | | | 321007 L 321006 R | 321005 L 321004 R | | | | |

| MODEL FAHRZEUG MODELE | YEAR JAHR ANNEE | FRONT | REAR | FRONT | REAR | FRONT | REAR | FRONT | REAR |
|--|---|--|------------------------|------------------------|----------------------|----------------------|--|--------------------------------|--------------------------------|
| | | | | | | | | PROTECTION KIT MOUNTING KIT | |
| Subaru (J) | | | | | | | | | |
| Impreza (GD), (GG) | | | | | | | | | |
| (GD) 1.5, 1.6, 2.0, 2.0 Turbo WRX 2.5, 2.5 WRX Exc. WRX-STi | 1.03 - 12.07 | | | 324033 L 324032 R | 324031 L 324030 R | 334461 L 334460 R | 334359 L 334358 R | 910142 SM5361 | 910046 SM8101 L SM8102 R |
| (GDB) 2.0 Turbo WRX-STi | 1.03 - 12.07 | | | 321003 L 321002 R | 321005 L 321004 R | | | | |
| (GG) 1.5, 1.6, 2.0, 2.0 i R, 2.0 Turbo WRX Exc. WRX-STi | 1.03 - 12.07 | | | 324035 L 324034 R | 324037 L 324036 R | 334463 L 334462 R | 334357 L 334356 R | 910142 SM5361 ¹⁾ | 910046 SM8101 L SM8102 R |
| 1) Incl. 2.5 , 2.5 WRX | | | | | | | | | |
| Suzuki (J) | | | | | | | | | |
| Swift III | | | | | | | | | |
| 1.3, 1.3 DDis, 1.5 Exc. | (MZ, EZ) 2.05 - 9.10 | | 733046 L▼ 733045 R▼ | 743048▼ | | 333409 L 333408 R | 343420 ¹⁾ Exc. 343464 | SM3703 | SM9930 |
| 1) Exc. OE p/n = 41800-63J02 | | | | | | | | | |
| Grand Vitara I (JSAF TA/TD/TL ..., 2S2GTA ...) | | | | | | | | | |
| 1.6 2.0 2.0 TD 2.0 HDI 2.5 Incl. ABS | (TA0: SQ416) (TA5, TL5: SQ420) (TD3: SQ420) (TD6: SQ425) | 3.98 - | | | 324051 L 324050 R | 243040 | 334196 L 334195 R | 343247 553158 | 940004 SM5366 |
| Toyota (J) | | | | | | | | | |
| Avensis (_T22_) | | | | | | | | | |
| 1.6, 1.8, 2.0 2.0 Diesel Turbo 1.9 D, 2.0 D | (AT220, AT221, ST220) (CT220) | 10.97 - 7.00 10.97 - 7.00 10.97 - 2.03 | | 734047 L▼ 734046 R▼ | | | 334204 L 334203 R | 334330 L 334329 R | 913267 910084 SM5087 |
| 1.6 VVTi 1.8 VVTi 2.0 VVTi 2.0 D-4D | (ZZT220) (ZZT221) (AZT220) (CDT220) | 7.00 - 12.02 | | 734047 L▼ 734046 R▼ | | | 334204 L 334203 R | 334330 L 334329 R | 913267 910084 SM5087 |
| Camry | | | | | | | | | |
| 2.0 i 2.4 3.0 i | (ACV31) (ACV30) (MCV30) | 8.01 - 7.03 | | | 324047 L 324046 R | 324049 L 324048 R | 334339 L 334338 R | 334341 L 334340 R | SM5423 935313 SM5175 |

| | | | | | | | | | |
|-----------------------------|-----------------------|-------|------|-------|------|--------------------------------|------|-------|------|
| MODEL FAHRZEUG MODELE | YEAR JAHR ANNEE | FRONT | REAR | FRONT | REAR | FRONT | REAR | FRONT | REAR |
| | | | | | | PROTECTION KIT MOUNTING KIT | | | |

Toyota (J)

Celica

| | | | | | | | | | |
|--|--------------|----------------------|------------------------|--|--|--|----------------------|--------|--------|
| (2WD) 1.8 (AT 200) 2.0 (ST 202) Exc. Super Strut sus. | 94 - 99 | 765017 | 734026 L▼ 734025 R▼ | | | 365092 ¹⁾ 334379 L ²⁾ 334378 R ²⁾ | 334126 L 334125 R | SM5164 | SM5087 |
| 1.8 (ZZT230) | 8.99 - 10.99 | 734022 L 734021 R | | | | 334278 L 334277 R | 341277 ³⁾ | SM5215 | SM5382 |
| 1.8 (ZZT230) | 10.99 - 8.00 | 734022 L 734021 R | 741056 ²⁾ ▼ | | | 334278 L 334277 R | 341278 ⁴⁾ | SM5215 | SM5382 |
| 1.8 (ZZT23#) | 8.00 - | 734022 L 734021 R | 741056 ²⁾ ▼ | | | 334278 L 334277 R | 341278 ⁴⁾ | SM5215 | SM5382 |

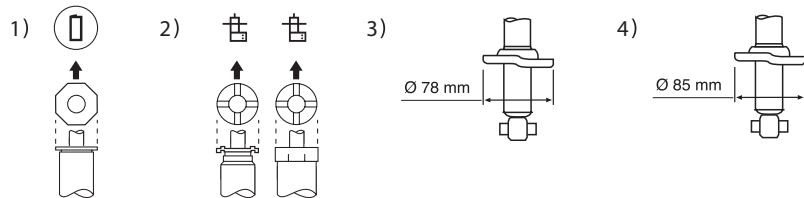

Corolla (No. = JT153***, JTB53***), (No. = JT172***, JTB72***) (4.97-9.01)

| | | | | | | | | | |
|---|-------------|--|--|--|--|--|--|--------|----------------------|
| 1300-16V, 1600-16V (EE111, AE111) 1400-16V, 1600-16V (ZZE111, ZZE112) Exc. Rough Road Package | 4.97 - 9.01 | 733039 L ¹⁾ 733038 R ¹⁾ | 734043 L ²⁾ ▼ 734042 R ²⁾ ▼ | 323064 L ¹⁾ 323063 R ¹⁾ | 324045 L ²⁾ 324044 R ²⁾ | 333237 L ¹⁾ 333236 R ¹⁾ | 334179 L ²⁾ 334178 R ²⁾ | SM5104 | SM5074 L SM5075 R |
|---|-------------|--|--|--|--|--|--|--------|----------------------|

Corolla (No. = JT152***, JTB52***), (No. = JT164***, JTB64***) (4.97-9.01)

| | | | | | | | | | |
|---|-------------|--|--|--|--|--|--|--------|----------------------|
| 1300-16V, 1600-16V (EE111, AE111) 1400-16V, 1600-16V (ZZE111, ZZE112) Exc. Rough Road Package | 4.97 - 9.01 | 733039 L ¹⁾ 733038 R ¹⁾ | 734043 L ²⁾ ▼ 734042 R ²⁾ ▼ | 323064 L ¹⁾ 323063 R ¹⁾ | 324045 L ²⁾ 324044 R ²⁾ | 333237 L ¹⁾ 333236 R ¹⁾ | 334179 L ²⁾ 334178 R ²⁾ | SM5104 | SM5074 L SM5075 R |
|---|-------------|--|--|--|--|--|--|--------|----------------------|

| 1) ↔ 2) | | 1) | 2) | | | | | | | | | | | | | | | | | | | | | | | | | | | | | | | | |
|----------------------|-------|--|--------|---|---|---|----------------------|--|--|--|----------------------|-------|--------|--------|----------------------|--|--|--|--|--|---|---|---|----------------------|--|--|--|----------------------|-------|--------|--------|----------------------|--|--|--|
| | | <table border="1"> <thead> <tr> <th></th> <th>a</th> <th>b</th> <th>c</th> </tr> </thead> <tbody> <tr> <td>333237 L 333236 R</td> <td></td> <td></td> <td></td> </tr> <tr> <td>323064 L 323063 R</td> <td>20 mm</td> <td>328 mm</td> <td>479 mm</td> </tr> <tr> <td>733039 L 733038 R</td> <td></td> <td></td> <td></td> </tr> </tbody> </table> | | a | b | c | 333237 L 333236 R | | | | 323064 L 323063 R | 20 mm | 328 mm | 479 mm | 733039 L 733038 R | | | | <table border="1"> <thead> <tr> <th></th> <th>a</th> <th>b</th> <th>c</th> </tr> </thead> <tbody> <tr> <td>334179 L 334178 R</td> <td></td> <td></td> <td></td> </tr> <tr> <td>324045 L 324044 R</td> <td>20 mm</td> <td>368 mm</td> <td>523 mm</td> </tr> <tr> <td>734043 L 734042 R</td> <td></td> <td></td> <td></td> </tr> </tbody> </table> | | a | b | c | 334179 L 334178 R | | | | 324045 L 324044 R | 20 mm | 368 mm | 523 mm | 734043 L 734042 R | | | |
| | a | b | c | | | | | | | | | | | | | | | | | | | | | | | | | | | | | | | | |
| 333237 L 333236 R | | | | | | | | | | | | | | | | | | | | | | | | | | | | | | | | | | | |
| 323064 L 323063 R | 20 mm | 328 mm | 479 mm | | | | | | | | | | | | | | | | | | | | | | | | | | | | | | | | |
| 733039 L 733038 R | | | | | | | | | | | | | | | | | | | | | | | | | | | | | | | | | | | |
| | a | b | c | | | | | | | | | | | | | | | | | | | | | | | | | | | | | | | | |
| 334179 L 334178 R | | | | | | | | | | | | | | | | | | | | | | | | | | | | | | | | | | | |
| 324045 L 324044 R | 20 mm | 368 mm | 523 mm | | | | | | | | | | | | | | | | | | | | | | | | | | | | | | | | |
| 734043 L 734042 R | | | | | | | | | | | | | | | | | | | | | | | | | | | | | | | | | | | |

Corolla (10.01-)

| | | | | | | | | | |
|--|---------|------------------------|---------|--|--------|----------------------|--------|--------------------------------|------------------|
| 1.4 VVTi (ZZE120) 1.4 D4D (NDE120) Exc. Rough Road Package | 10.01 - | 733048 L▼ 733047 R▼ | 741070▼ | | 351701 | 333359 L 333358 R | 341816 | SM5215 | 910053 SM5382 |
| 1.6 (ZZE121) Exc. Rough Road Package | 10.01 - | 733048 L▼ 733047 R▼ | 741070▼ | | 351701 | 333359 L 333358 R | 341816 | SM5215 | 910053 SM5382 |
| 2.0 D4D (CDE120) Exc. Rough Road Package | 10.01 - | 733048 L▼ 733047 R▼ | 741070▼ | | 351701 | 333359 L 333358 R | 341816 | 910283 ¹⁾ SM5215 | 910053 SM5382 |

1) → 5.04

| MODEL FAHRZEUG MODELE | YEAR JAHR ANNEE | FRONT | REAR | FRONT | REAR | FRONT | REAR | FRONT | REAR |
|---|-----------------------|--|--|----------------------|--------|--|--|--------------------------------|--|
| | | | | | | | | PROTECTION KIT MOUNTING KIT | |
| Toyota (J) | | | | | | | | | |
| Corolla (10.01-) | | | | | | | | | |
| 1.4 (ZZE120) 1.4 D4D (NDE120) 1.6 VVTi (ZZE121) Exc. Rough Road Package | 10.01 - | 733048 L▼ 733047 R▼ | 741070▼ | | 351701 | 333359 L 333358 R | 341816 | SM5215 | 910053 SM5382 |
| 2.0 D4D (CDE120) Exc. Rough Road Package | 10.01 - | 733048 L▼ 733047 R▼ | 741070▼ | | 351701 | 333359 L 333358 R | 341816 | 910283 ¹⁾ SM5215 | 910053 SM5382 |
| 1) → 5.04 | | | | | | | | | |
| Corolla (9.02-) (E12U_) | | | | | | | | | |
| 1.4 (ZZE120) 1.4 D (NDE120) 1.4 VVTi (ZZE111) 1.6 (ZZE121) 1.6 VVTi (ZZE112) 1.8 (ZZE123) 2.0 TD (CDE120) 2.0 D4D (CDE120) | 9.02 - | | 741070▼ | 324701 L 324700 R | 351701 | 334818 L 334817 R | 341816 | 910049 SM5215 | 910053 SM5382 |
| Corolla (= SB164***) (4.97-11.01) | | | | | | | | | |
| 1300-16V, 1600-16V (EE111, AE111) | 1.99 - 7.99 | 733039 L ¹⁾ 733038 R ¹⁾ | 734043 L ²⁾ ▼ 734042 R ²⁾ ▼ | | | 333237 L ¹⁾ 333236 R ¹⁾ | 334179 L ²⁾ 334178 R ²⁾ | SM5104 | 910254 ³⁾ SM5074 L SM5075 R |
| 1) ↔ 2) | | | | | | | | | |
| | 1) | | | 2) | | | 3) | | |
| | | 333237 L 333236 R 323064 L 323063 R 733039 L 733038 R | a | b | c | 334179 L 334178 R 324045 L 324044 R 734043 L 734042 R | a | b | c |
| | | | 20 mm | 328 mm | 479 mm | | 20 mm | 368 mm | 523 mm |
| Corolla (1.02-) | | | | | | | | | |
| 1.4 (ZZE120) 1.4 D, D4D (ZZE121) 1.6 (ZZE121) 2.0 TD (CDE120) | 1.02 - | | 741070▼ | 324701 L 324700 R | 351701 | 334818 L 334817 R | 341816 | 910049 SM5215 | 910053 SM5382 |
| Corolla (E12U_) (11.01-) | | | | | | | | | |
| 1.4 (ZZE120) 1.4 D (ZZE121) 1.4 VVTi (ZZE120) 1.6 (ZZE121) 1.6 VVTi (ZZE121) 1.8 (ZZE123) 1.8 VVTi (ZZE123) 2.0 TD (CDE120) 2.0 D4D (CDE120) Exc. Rough Road Package | 11.01 - | | 741070▼ | 324701 L 324700 R | 351701 | 334818 L 334817 R | 341816 | 910049 SM5215 | 910053 SM5382 |
| Corolla Verso | | | | | | | | | |
| 1.4 D4D, 1.4 D (ZZE121) 1.6 VVTi (ZZE121) 1.8 VVTi (ZZE122) | 9.01 - 12.03 | | 741070▼ | | 351701 | 333359 L 333358 R | 341816 | 910048 SM5215 | 910053 SM5382 |
| 2.0 D4D (CDE120) | 9.01 - 12.03 | | 741070▼ | | 351701 | 333359 L 333358 R | 341816 | 910283 ¹⁾ SM5215 | 910053 SM5382 |
| 1) → 5.04 | | | | | | | | | |

| MODEL FAHRZEUG MODELE | YEAR JAHR ANNEE | FRONT | REAR | FRONT | REAR | FRONT | REAR | FRONT | REAR |
|-----------------------------|-----------------------|-------|------|-------|------|-------|------|--------------------------------|------|
| | | | | | | | | PROTECTION KIT MOUNTING KIT | |

Toyota (J)

Land Cruiser

| | | | | | | | | | |
|-------------------|-------------|--------|---------|--------|--------|--------|--------|--|--|
| KZJ 90 3.0 Diesel | 3.96 - 9.02 | 741068 | 743041▼ | 351031 | 354005 | 341232 | 344288 | | |
| KZJ 95 3.0 Diesel | | | | | | | | | |
| KDJ 90 3.0 Diesel | | | | | | | | | |
| KDJ 95 3.0 Diesel | | | | | | | | | |
| VZJ 90 3.4 | | | | | | | | | |
| VZJ 95 3.4 | | | | | | | | | |
| Exc. | | | | | | | | | |

MR 2

| | | | | | | | | | | |
|----------------------|--------|---------|---------|---------|--|--|--------|--------|--------|--|
| 2.0 16V Incl. ABS | (SW20) | 90 - 00 | 765015▼ | 765016▼ | | | 365099 | 365100 | SM5161 | |
|----------------------|--------|---------|---------|---------|--|--|--------|--------|--------|--|

RAV 4 (2WD) (4WD)

| | | | | | | | | | | |
|--------|---------|-------------|--|--|-------------------------|----------------------|------------------------|----------------------|--------|--|
| | (SXA10) | 4.94 - 1.98 | | | 375035 ^{1)▼} | 243033 ³⁾ | 365093 ¹⁾ | 343272 ³⁾ | 910110 | |
| | (SXA11) | 1.98 - 4.00 | | | 324039 L ^{2)▼} | | 334483 L ²⁾ | | SM5162 | |
| | | | | | 324038 R ^{2)▼} | | 334482 R ²⁾ | | | |
| | (SXA10) | 8.96 - 4.00 | | | 324039 L ^{2)▼} | | 334483 L ²⁾ | 343313 ⁴⁾ | 910110 | |
| | | | | | 324038 R ^{2)▼} | | 334482 R ²⁾ | | SM5162 | |
| | (ZCA25) | 5.00 - | | | 324057 L | 243033 | 3340114 L | 343272 | 910050 | |
| 1.8 | (ACA20) | | | | 324056 R | | 3340113 R | | SM5162 | |
| 2.0 TD | (CLA20) | | | | | | | | | |
| 2.0 D | | | | | | | | | | |
| | (ZCA26) | 5.00 - | | | 325002 L | 243033 | 335041 L | 343272 | 910050 | |
| 1.8 | (ACA21) | | | | 325001 R | | 335040 R | | SM5162 | |
| 2.0 TD | (CLA21) | | | | | | | | | |
| 2.0 D | | | | | | | | | | |

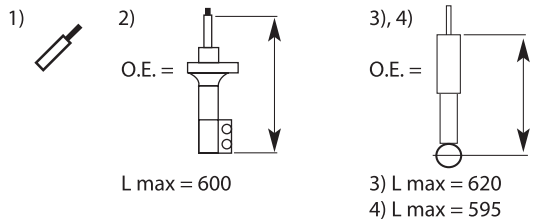

Yaris I

| | | | | | | | | | | |
|-------------------|--------|--------------|--|--|--------|--------|--------|--------|------------------------|------------------------|
| 1.0 (2WD) | (_P10) | 3.99 - 1.06 | | | 323058 | 353015 | 333368 | 343431 | 910047 ¹⁾²⁾ | 910052 ¹⁾⁴⁾ |
| 1.3 (2WD) | | 3.99 - 1.06 | | | | | | | SM5472 ¹⁾³⁾ | SM9905 ¹⁾⁵⁾ |
| 1.4 TD, D4D (2WD) | | 10.01 - 1.06 | | | | | | | SM1024 ¹⁾³⁾ | |
| | | | | | | | | | SM1025 ¹⁾³⁾ | |
| 1.5 (2WD) | (_P10) | 1.01 - 1.06 | | | 323058 | 353024 | 333368 | 343805 | 910047 ¹⁾²⁾ | 910052 ¹⁾⁴⁾ |
| | | | | | | | | | SM5472 ¹⁾³⁾ | SM9905 ¹⁾⁵⁾ |
| | | | | | | | | | SM1024 ¹⁾³⁾ | |
| | | | | | | | | | SM1025 ¹⁾³⁾ | |

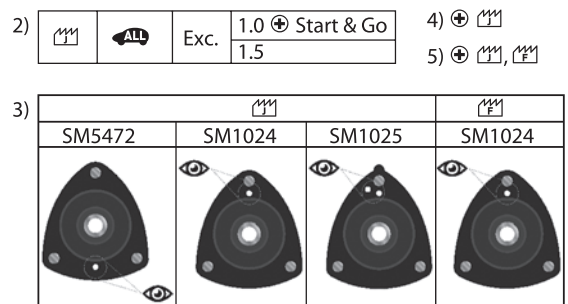
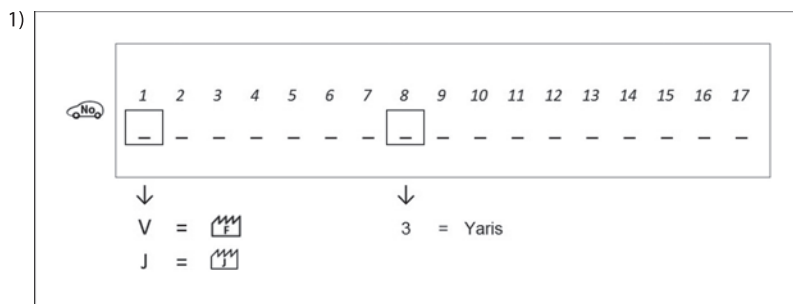

| MODEL FAHRZEUG MODELE | YEAR JAHR ANNEE | FRONT | REAR | FRONT | REAR | FRONT | REAR | FRONT | REAR | | | | | | |
|--|-----------------------|---------|------|--------|----------------|---------|-----------------------------------|---|------|-------|-----|-----------------------|--------|---------------------------|--------|
| | | | | | | | | PROTECTION KIT MOUNTING KIT | | | | | | | |
| Vauxhall (GB) | | | | | | | | | | | | | | | |
| Astra Exc. VXR / | | | | | | | | | | | | | | | |
| | 2.80 - 8.84 | 765021▼ | | 375009 | 243014 | 365501 | 343047 553075▼ | 915322▼ 910083 | | | | | | | |
| Exc. GTE | 9.84 - 91 | 765021▼ | | 375009 | 243014 | 365501 | 343047 553075▼ | 915322▼ 910083 SM1300 ¹⁾ ▼ SM1307 ¹⁾ ▼ | | | | | | | |
| 1.8 GTE | 9.84 - 91 | 765021▼ | | 375009 | 243014 | 365501 | 343047 553075▼ | 915322▼ 910083 SM1307▼ | | | | | | | |
| Astra F Exc. 1.8 i/2.0i SRi, GSi, Gt | 8.91 - 98 | | | 375034 | 243014 | 365504 | 343047 553075▼ | 910160▼ SM1303 | | | | | | | |
| Astra F 1.8 i/2.0 i SRi, GSi | 8.91 - 9.98 | | | 375034 | 243014 | 365504 | 343047 553075▼ | 910160▼ SM1303 | | | | | | | |
| 1) <table border="1"> <tr> <th>Model</th> <th>KYB</th> </tr> <tr> <td>1.2 / 1.3 / 1.4 / 1.6 </td> <td>SM1300</td> </tr> <tr> <td>1.6 / 1.8 / 2.0 / Diesel</td> <td>SM1307</td> </tr> </table> | | | | | | | | | | Model | KYB | 1.2 / 1.3 / 1.4 / 1.6 | SM1300 | 1.6 / 1.8 / 2.0 / Diesel | SM1307 |
| Model | KYB | | | | | | | | | | | | | | |
| 1.2 / 1.3 / 1.4 / 1.6 | SM1300 | | | | | | | | | | | | | | |
| 1.6 / 1.8 / 2.0 / Diesel | SM1307 | | | | | | | | | | | | | | |
| Belmont | | | | | | | | | | | | | | | |
| | 86 - 91 | | | 375009 | 243014 | 365501 | 343047 553075▼ | 915322▼ 910083 | | | | | | | |
| Calibra | | | | | | | | | | | | | | | |
| 2.0 i (2WD) (4WD) Exc. 16V, 16V-Turbo | 90 - 98 | | | 375032 | 353011▼ | 365503 | 343259 | 910083 SM1301 | | | | | | | |
| 2.0 i 16V (2WD) (4WD) 2.0 i 16V Turbo (4WD) 2.5 i 16V (2WD) | 90 - 98 | | | 375032 | 353011▼ | 365503 | 343259 | 910083 SM1301 | | | | | | | |
| Cavalier, Vectra | | | | | | | | | | | | | | | |
| | 8.75 - 6.81 | | | 244029 | 244030▼ | 343048▼ | 343006 | | | | | | | | |
| (2WD) Exc. 2000-16 V, 2.5 V6 | 9.88 - 95 | | | 375032 | 243014 Exc. | 365503 | 343047 Exc. 553075▼ Exc. | 910083 SM1301 | | | | | | | |
| 2000-16 V (2WD) (1 = 20XE, C 20XE) → P1000001 → P5000001 → P7000001 | 93 - 95 | | | 375032 | 243014 Exc. | 365503 | 343047 Exc. 553075▼ Exc. | 910083 SM1301 | | | | | | | |
| (2WD) 2.5 i V6 | 93 - 95 | | | 375032 | 243014 Exc. | 365503 | 343047 Exc. 553075▼ Exc. | 910083 SM1301 | | | | | | | |

| MODEL FAHRZEUG MODELE | YEAR JAHR ANNEE | FRONT | REAR | FRONT | REAR | FRONT | REAR | FRONT | REAR |
|--|-----------------------|--------|--------|--------|---------|---------|-------------------|--------------------------------|--|
| | | | | | | | | PROTECTION KIT MOUNTING KIT | |
| Vauxhall (GB) | | | | | | | | | |
| Chevette | | | | | | | | | |
| ALL | 6.76 - 84 | | | 244029 | 244030▼ | 343048▼ | 343006 | | |
| Nova, Corsa | | | | | | | | | |
| Nova ALL Exc. GTE, GSi | 83 - 2.93 | | | 323034 | 353012 | 333831 | 343265 553155▼ | 910083 SM1305 | |
| Nova GTE, GSi | 83 - 2.93 | | | 323034 | 353012 | 333831 | 343265 553155▼ | 910083 SM1305 | |
| Corsa ALL Exc. GSi, Sport | 3.93 - 9.00 | | | 323034 | 353012 | 333831 | 343265 553155▼ | 910083 SM2302 | |
| Corsa GSi, Sport | 3.93 - 9.00 | | | 323034 | 353012 | 333831 | 343265 553155▼ | 910083 SM2302 | |
| Tigra | | | | | | | | | |
| ALL | 94 - 1.01 | | | 323034 | 353012 | 333831 | 343265 553155▼ | 910083 SM2302 | |
| Volkswagen (D) | | | | | | | | | |
| Bora , Jetta IV | | | | | | | | | |
| (1J) 1.4, 1.6 Exc. Sport sus., | 9.97 - 5.05 | 734033 | 743029 | 324016 | 243037 | 333713 | 343348 553206 | 915415 SM1708 | 915400 SM9703 ¹⁾ SM9704 ²⁾ |
| (1J) 1.8, 1.8 Turbo, 2.0, 2.3, 1.9 SDI, 1.9 TDI Exc. Sport sus., | 9.97 - 5.05 | 734033 | 743029 | 324016 | 243037 | 334812 | 343348 553206 | 915415 SM1708 | 915400 SM9703 ¹⁾ SM9704 ²⁾ |
| (1J) ⊕ Sport sus. Exc. 2.8 V6 | 9.97 - 5.05 | 734033 | 743029 | 324016 | 243037 | 334812 | 553206 | 915415 SM1708 | 915400 SM9703 ¹⁾ SM9704 ²⁾ |
| (1J) 1.8, 2.3, 1.9 TDI Exc. Sport sus., 2.8-V6 | 9.97 - 5.99 | | | 324016 | | 334812 | 343310 553243 | 915415 SM1708 | |
| (1J) ⊕ Sport sus. Exc. 2.8 V6 | 9.97 - 5.99 | | | 324016 | | 334812 | 343310 553243 | 915415 SM1708 | |
| 1) SM9703 : OE p/n = 1J0513353D 2) SM9704 : OE p/n = 1J0513353B | | | | | | | | | |
| Bora Variant | | | | | | | | | |
| (1J) ⊕ Sport sus. | 99 - 5.05 | 734033 | 743029 | 324016 | 243037 | 334812 | 553206 | 915415 SM1708 | 915400 SM9703 ¹⁾ SM9704 ²⁾ |
| 1) SM9703 : OE p/n = 1J0513353D 2) SM9704 : OE p/n = 1J0513353B | | | | | | | | | |

AGX

| MODEL FAHRZEUG MODELE | YEAR JAHR ANNEE | FRONT | REAR | FRONT | REAR | FRONT | REAR | FRONT | REAR |
|-----------------------------|-----------------------|-------|------|-------|------|-------|------|--------------------------------|------|
| | | | | | | | | PROTECTION KIT MOUNTING KIT | |

Volkswagen (D)

Corrado

| | | | | | | | | | | |
|--------------------------------------|-------|--------------|---------|---------|--------|----------------------|--------|----------------------|--|------------------|
| 1.8 16V, 1.8 G60 2.0 i, 2.0 i 16V | (53i) | 8.87 - 12.95 | 734039▼ | 741062▼ | 324025 | 353013 ¹⁾ | 334810 | 343258 ¹⁾ | 915401 SM1700 ²⁾ SM1704 ³⁾ | 910087 SM9700 |
| VR 6 | (53i) | 8.91 - 12.95 | 734039▼ | 741062▼ | 324025 | 353013 ¹⁾ | 334810 | 343191 ¹⁾ | SM1704 ³⁾ | 910087 SM9700 |

1) 2), 3)

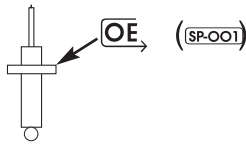

| | Year | KYB |
|---------|--------------|--------|
| 1.8 16V | 4.89 - 7.92 | SM1700 |
| 1.8 G60 | 9.88 - 9.93 | SM1700 |
| 2.0 16V | 8.91 - 7.94 | SM1700 |
| 2.0 16V | 8.94 - 12.95 | SM1704 |

Eos (1F7)

| | | | | | | | | | | |
|--|-------|--------|--|--|--------|--|--------|--------|--|------------------|
| 1.4 TSi, 1.6 FSi, 2.0 FSi 2.0 TFSi, 2.0 TSi, 2.0 TDi, 2.0 TDi 16V 3.2 V6, 3.6 V6 Incl. Sport sus. | (1F7) | 3.06 - | | | 325700 | | 335808 | 349022 | 910059 ¹⁾ 910057 ²⁾ SM1714 | 915400 SM9711 |
|--|-------|--------|--|--|--------|--|--------|--------|--|------------------|

1) 910059 : Normal sus. 2) 910057 : Sport sus.

Fox (5Z1)

| | | | | | | | | | | |
|-----------------------|-------|--------|--|--|--------|--|--------|--------|------------------|------------------|
| 1.2 i, 1.4 i, 1.4 TDI | (5Z1) | 4.05 - | | | 324702 | | 334835 | 343438 | 910084 SM1713 | 915400 SM9704 |
|-----------------------|-------|--------|--|--|--------|--|--------|--------|------------------|------------------|

Golf I, Jetta I Exc.

| | | | | | | | | | | |
|---|--|-----------------------------|--|--|----------------------|--------|----------------------|--------|------------------|--|
| Golf Jetta Exc. GTI, Turbo Diesel | | 73 - 8.83 8.78 - 2.84 | | | 373012 ¹⁾ | 351007 | 363001 ¹⁾ | 341007 | 910088 SM5508 | |
| Golf GTI, Turbo Diesel Jetta GTI, Turbo Diesel | | 9.76 - 12.83 9.76 - 2.84 | | | 373012 ¹⁾ | 351007 | 363001 ¹⁾ | 341007 | 910088 SM5508 | |

1) (RN-001)

Golf II, Jetta II Exc.

| | | | | | | | | | | |
|---|--|------------------------------|---------|---------|----------------------------------|----------------------|--------------------------------|----------------------|-----------------------------|------------------|
| Golf Jetta → 1 G LW 320000 Exc. GTI, GTI 16 V, G60 | | 8.83 - 12.89 3.84 - 12.89 | 734039▼ | 741062▼ | 374006 ¹⁾ ▼ 324025 | 353013 ²⁾ | 364014 ¹⁾ 333712 | 343191 ²⁾ | 915401 SM1701▼ SM1700 | 910087 SM9700 |
| Golf / Jetta 1 G LW 320001 → Exc. GTI, GTI 16 V, G60 | | 1.90 - 92 | 734039▼ | 741062▼ | 324025 | 353013 ²⁾ | 333712 | 343191 ²⁾ | 915401 SM1701▼ SM1700 | 910087 SM9700 |
| Golf GTI Exc. 16V, G60 Jetta GTI, GT 16V | | 1.84 - 12.89 3.84 - 12.89 | 734039▼ | 741062▼ | 374006 ¹⁾ ▼ 324025 | 353013 ²⁾ | 364014 ¹⁾ 333712 | 343191 ²⁾ | 915401 SM1701▼ SM1700 | 910087 SM9700 |

1) (RN-001)

2) OE, (SP-001)

| MODEL FAHRZEUG MODELE | YEAR JAHR ANNEE | FRONT | REAR | FRONT | REAR | FRONT | REAR | FRONT | REAR |
|-----------------------------|-----------------------|-------|------|-------|------|-------|------|--------------------------------|------|
| | | | | | | | | PROTECTION KIT MOUNTING KIT | |

Volkswagen (D)

Golf II, Jetta II Exc.

| | | | | | | | |
|---|--|------------------------------|--------------------|----------------------------------|--|---|------------------|
| Golf GTI Exc. 16V, G60 Jetta GTi, GT 16V | | 1.90 - 92 1.90 - 92 | 734039▼ 741062▼ | 324025 353013 ²⁾ | 333712 343191 ²⁾ | 915401 SM1701▼ SM1700 | 910087 SM9700 |
| Golf GTI 16V | | 2.86 - 12.89 | 734039▼ 741062▼ | 374006 ¹⁾ ▼ 324025 | 353013 ²⁾ 364014 ¹⁾ 333712 | 343258 ²⁾ 915401 SM1701▼ SM1700 | 910087 SM9700 |
| Golf GTI 16V | | 1.90 - 92 | 741062▼ | 324025 353013 ²⁾ | 333712 343258 ²⁾ | 915401 SM1701▼ SM1700 | 910087 SM9700 |
| Golf 1.8 GTi G60 | | 10.89 - 7.91 | 734039▼ 741062▼ | 324025 353013 ²⁾ | 334810 343258 ²⁾ | 915401 SM1700 | 910087 SM9700 |
| Golf Syncro Exc. Rally, Country Jetta Syncro | | 2.86 - 12.89 8.87 - 12.89 | 734039▼ | 374006 ¹⁾ ▼ 324025 | 364014 ¹⁾ 333712 | 343274 ²⁾ 915401 SM1701▼ SM1700 | 910087 SM9700 |
| Golf Syncro Exc. Rally, Country Jetta Syncro | | 1.90 - 92 1.90 - 92 | 734039▼ | 324025 | 333712 343274 ²⁾ | 915401 SM1701▼ SM1700 | SM9700 |



Golf III, Vento , Jetta III Exc.

| | | | | | | | |
|---|------|------------|--------------------|--------------------------------|--------------------------------|---|------------------|
| Golf, Vento 1.4 i, 1.6 i, 1.8 i 1.9 Diesel, 1.9 Turbo Diesel, 1.9 TDI Incl. GT | (1H) | 9.91 - 98 | 734039▼ 741062▼ | 324025 353013 ¹⁾ | 333712 343191 ¹⁾ | 915401 ²⁾ 910088 SM1701▼ SM1700 ³⁾ SM1704 ³⁾ | 910087 SM9700 |
| Golf, Vento 2.0 GTi, 2.0 16V GTi, 2.8 VR6 2.8V, 1.9 SDI 2.0 8V | (1H) | 9.91 - 98 | 734039▼ 741062▼ | 324025 353013 ¹⁾ | 334810 343258 ¹⁾ | 910088 SM1701▼ SM1700 ³⁾ SM1704 ³⁾ | 910087 SM9700 |
| Golf Syncro 1.8 Exc. Country | (1H) | 1.93 - 98 | | 324025 | 333712 | 910088 SM1701▼ SM1700 | |
| Golf, Vento Syncro 2.0, 2.9 VR6, 1.9 TDI Exc. Country | (1H) | 10.94 - 98 | | 324025 | 334810 | 910088 SM1701▼ SM1700 | |

Golf III Variant

| | | | | | | | |
|--|------|-----------|--|--------|-------------------|---|--------|
| 1.4 i, 1.6 i, 1.8 i 1.9 D, 1.9 TD, 1.9 TDI Exc. Syncro | (1H) | 9.93 - 98 | | 324025 | 333712 341803▼ | 915401 ²⁾ 910088 SM1701▼ SM1700 ³⁾ SM1704 ³⁾ | 913145 |
|--|------|-----------|--|--------|-------------------|---|--------|

| | | | | | | | | | |
|-----------------------------|-----------------------|-------|------|-------|------|--------------------------------|------|-------|------|
| MODEL FAHRZEUG MODELE | YEAR JAHR ANNEE | FRONT | REAR | FRONT | REAR | FRONT | REAR | FRONT | REAR |
| | | | | | | PROTECTION KIT MOUNTING KIT | | | |

Volkswagen (D)

Golf III Variant

| | | | | | | | | | | |
|--------------------------------------|------|-----------|--|--|--------|--|--------|---------|---|--------|
| 2.0, 1.9 SDI, 2.9 VR6 Exc. Syncro | (1H) | 9.93 - 98 | | | 324025 | | 334810 | 341803▼ | 910088 SM1701▼ SM1700 ³⁾ SM1704 ³⁾ | 913145 |
|--------------------------------------|------|-----------|--|--|--------|--|--------|---------|---|--------|

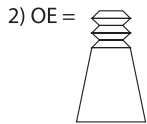
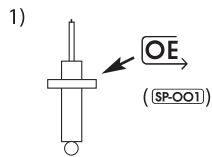

3)

| Model | | Year | KYB | |
|--|------------------------------|------------|------------|------------|
| Golf III | 1.4 / 1.6 | 9.91- 8.94 | SM1700 | |
| | | 8.94- 98 | SM1704 | |
| | 1.8 | AAM | 9.91- 8.94 | SM1700 |
| | | | 8.94- 98 | SM1704 |
| | | ABS | 9.91- 8.94 | SM1700 |
| | | | 8.94- 6.95 | SM1704 |
| | ADZ | 10.94- 98 | SM1704 | |
| | | ACC | 12.94- 98 | SM1704 |
| | 1.9 D / 1.9 TD / 2.0 / 2.8 | 9.91- 8.94 | SM1700 | |
| | | 8.94- 98 | SM1704 | |
| | 1.9 TDI | 6.93- 8.94 | SM1700 | |
| | | 7.95- 98 | SM1704 | |
| 1.9 SDI / 2.0 GL / 2.0 GTI 16V / 2.8 VR6 | 1.92- 9.97 | SM1704 | | |
| Vento | 1.4 / 1.6 | 9.91- 8.94 | SM1700 | |
| | | 9.91- 8.94 | SM1700 | |
| | 1.4 / 1.6 | 8.94- 98 | SM1704 | |
| | | 1.8 | AAM | 9.91- 8.94 |
| | 1.8 | AAM | 9.91- 8.94 | SM1700 |
| | 1.8 | ABS | 9.91- 8.94 | SM1704 |
| | 1.8 | | 8.94- 98 | SM1704 |
| | 1.9 SDI | | 7.95- 98 | SM1704 |
| | 1.9 TD / 1.9 TDI / 2.0 / 2.8 | 9.91- 8.94 | SM1700 | |
| | | 8.94- 98 | SM1704 | |

| Model | | Year | KYB | |
|------------------|----------------------------|------------|------------|--------|
| Golf III Variant | 1.4 / 1.6 | 9.91- 8.94 | SM1700 | |
| | | 8.94- 98 | SM1704 | |
| | 1.8 | AAM | 9.91- 8.94 | SM1700 |
| | | | 8.94- 98 | SM1704 |
| | | ABS | 9.91- 8.94 | SM1700 |
| | | | 8.94- 6.95 | SM1704 |
| | ADZ | 10.94- 98 | SM1704 | |
| | | ACC | 12.94- 98 | SM1704 |
| | 1.9 D / 1.9 TD / 2.0 / 2.8 | 9.91- 8.94 | SM1700 | |
| | | 8.94- 98 | SM1704 | |
| | 1.9 TDI | 6.93- 8.94 | SM1700 | |
| | | 8.94- 98 | SM1704 | |

Golf IV

| | | | | | | | | | | |
|--|-------|--------------|--------|--------|--------|--------|--------|------------------|------------------|--|
| 1.4, 1.6, 1.6 FSI Exc. Sport sus., | (1J1) | 9.97 - 10.03 | 734033 | 743029 | 324016 | 243037 | 333713 | 343348 553206 | 915415 SM1708 | 915400 SM9703 ¹⁾ SM9704 ²⁾ |
| 1.8, 1.8 Turbo, 2.0, 2.3, 1.9 SDI, 1.9 TDI Exc. Sport sus., | (1J1) | 9.97 - 10.03 | 734033 | 743029 | 324016 | 243037 | 334812 | 343348 553206 | 915415 SM1708 | 915400 SM9703 ¹⁾ SM9704 ²⁾ |
| Sport sus. | (1J1) | 9.97 - 10.03 | 734033 | 743029 | 324016 | 243037 | 334812 | 553206 | 915415 SM1708 | 915400 SM9703 ¹⁾ SM9704 ²⁾ |

1) SM9703 : OE p/n = 1J0513353D

2) SM9704 : OE p/n = 1J0513353B

| MODEL FAHRZEUG MODELE | YEAR JAHR ANNEE | FRONT | REAR | FRONT | REAR | FRONT | REAR | FRONT | REAR |
|---|-----------------------|---------------------------------|---------|--|----------------------|--|----------------------|--|--|
| | | | | | | | | PROTECTION KIT MOUNTING KIT | |
| Volkswagen (D) | | | | | | | | | |
| Golf IV | | | | | | | | | |
| (4WD) (1J1) 1.8, 2.3, 1.9 TDI → 1J-X-800 000 Exc. Sport sus., , 2.8 V6 | 9.97 - 5.99 | | | 324016 | | 334812 | 343310 553243 | 915415 SM1708 | |
| (4WD) (1J1) → 1J-X-800 000 ⊕ Sport sus. Exc. 2.8 V6, 3.2 R32 | 9.97 - 5.99 | | | 324016 | | 334812 | 343310 553243 | 915415 SM1708 | |
| Golf IV Variant | | | | | | | | | |
| (2WD) (1J5) ⊕ Sport sus. | 99 - 6.06 | 734033 | 743029 | 324016 | 243037 | 334812 | 553206 | 915415 SM1708 | 915400 SM9703 ¹⁾ SM9704 ²⁾ |
| 1) SM9703 : OE p/n = 1J0513353D | | 2) SM9704 : OE p/n = 1J0513353B | | | | | | | |
| Golf V | | | | | | | | | |
| (2WD) (4WD) (1K1) Exc. Sport sus., , Gti, 3.2 | 10.03 - 2.09 | | | 324703 ¹⁾ 325700 ²⁾ | 354006 | 334834 ¹⁾ 335808 ²⁾ | 344459 | 910059 ³⁾ 910057 ⁴⁾ 910177 ⁵⁾ SM1714 | 915400 ⁶⁾ 910045 ⁷⁾ SM9707 ⁶⁾ SM9708 ⁷⁾ |
| Golf V Variant | | | | | | | | | |
| (2WD) (4WD) (1K5) Exc. Sport sus., | 6.07 - | | | 324703 ¹⁾ 325700 ²⁾ | 354006 | 334834 ¹⁾ 335808 ²⁾ | 344459 | 910059 ³⁾ 910057 ⁴⁾ 910177 ⁵⁾ SM1714 | 915400 ⁶⁾ 910045 ⁷⁾ SM9707 ⁶⁾ SM9708 ⁷⁾ |
| Golf V Plus | | | | | | | | | |
| (2WD) (5M1) ⊕ Sport sus. Exc. | 1.05 - | | | 324703 ¹⁾ 325700 ²⁾ | 354006 | 334834 ¹⁾ 335808 ²⁾ | 344459 | 910059 ³⁾ 910057 ⁴⁾ 910177 ⁵⁾ SM1714 | 915400 ⁶⁾ 910045 ⁷⁾ SM9707 ⁶⁾ SM9708 ⁷⁾ |
| 1) | | | | | | | | | |
| 2) | | | | | | | | | |
| 3) ⊕ Normal sus. 4) ⊕ Sport sus. 5) ⊕ | | | | | | | | | |
| 6) "/> | | | | | | | | | |
| 7) "/> | | | | | | | | | |
| Golf Cabrio | | | | | | | | | |
| Golf I (155) | 76 - 93 | | | 373012 ¹⁾ | 351007 | 363001 ¹⁾ | 341007 | 910088 SM5508 | |
| Golf III (1E7) Incl. Sport sus. | 9.93 - 2.98 | 734039▼ | 741062▼ | 324025 | 353013 ²⁾ | 334810 | 343191 ²⁾ | 910088 SM1704 | 910087 SM9700 |

| MODEL FAHRZEUG MODELE | YEAR JAHR ANNEE | FRONT | REAR | FRONT | REAR | FRONT | REAR | FRONT | REAR |
|-----------------------------|-----------------------|-------|------|-------|------|-------|------|--------------------------------|------|
| | | | | | | | | PROTECTION KIT MOUNTING KIT | |

Volkswagen (D)

Golf Cabrio

| | | | | | | | | | | |
|---------------------------------|-------|-------------|---------|---------|--------|----------------------|--------|----------------------|------------------|------------------|
| Golf IV Incl. Sport sus. | (1E7) | 3.98 - 6.02 | 734039▼ | 741062▼ | 324025 | 353013 ²⁾ | 334810 | 343191 ²⁾ | 910088 SM1704 | 910087 SM9700 |
|---------------------------------|-------|-------------|---------|---------|--------|----------------------|--------|----------------------|------------------|------------------|

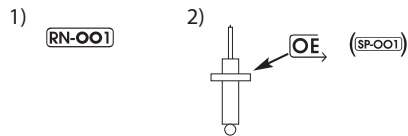

Jetta V

| | | | | | | | | | | |
|----------------------|-------|--------------|--|--|--|--------|--|--------|--|--|
| Exc. Sport sus., | (1K2) | 8.05 - 10.10 | | | 324703 ¹⁾ 325700 ²⁾ | 354006 | 334834 ¹⁾ 335808 ²⁾ | 344459 | 910059 ³⁾ 910057 ⁴⁾ 910177 ⁵⁾ SM1714 | 915400 ⁶⁾ 910045 ⁷⁾ SM9707 ⁶⁾ SM9708 ⁷⁾ |
|----------------------|-------|--------------|--|--|--|--------|--|--------|--|--|

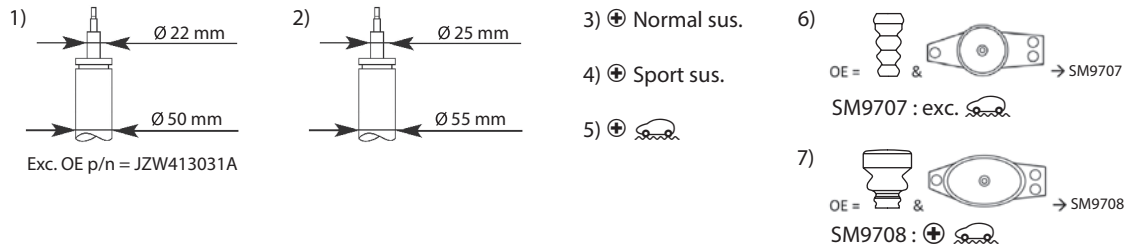

Jetta VI

| | | | | | | | | | | |
|------------------------------|-------|--------|--|--|--|--------|--|--------|--|--|
| Incl. Sport sus. Exc. | (162) | 4.10 - | | | 324703 ¹⁾ 325700 ²⁾ | 354006 | 334834 ¹⁾ 335808 ²⁾ | 344459 | 910059 ⁵⁾ 910057 ⁶⁾ SM1714 | SM9707 ³⁾ SM9708 ⁴⁾ |
| ⊕ Exc. Sport sus. | (162) | 4.10 - | | | 324703 ¹⁾ 325700 ²⁾ | | 334834 ¹⁾ 335808 ²⁾ | 349137 | SM1714 | |

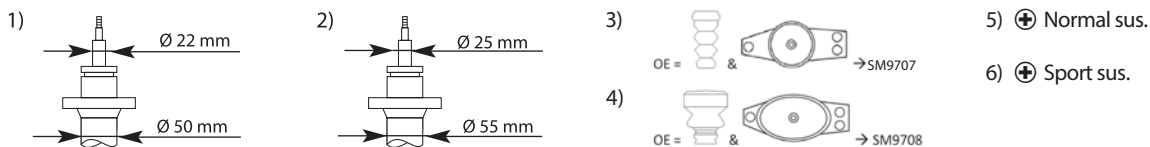

Lupo

| | | | | | | | | | | |
|---|------|-----------|--|--|--------|--|--------|--------|------------------|--|
| 1.0, 1.4, 1.4 TDi, 1.7 SDi Exc. 1.2 TDi 3L | (6X) | 98 - 7.05 | | | 324025 | | 333712 | 343309 | 915401 SM1707 | 910280 ¹⁾ 910281 ¹⁾ SM9939 |
|---|------|-----------|--|--|--------|--|--------|--------|------------------|--|

1)

| | KYB |
|--|--------|
| 1.0, 1.2 TDi 3L, 1.4, 1.4 16V (55 kW), 1.4 TDi, 1.7 SDi | 910280 |
| 1.4 16V (74 kW), 1.4 FSi, 1.6 GTi | 910281 |

New Beetle (1C, 9C)

| | | | | | | | | | | |
|--------------|----------|-------------|--|--|--------|--------|--------|------------------|------------------|--|
| Exc. RSi | (1C, 9C) | 1.98 - 9.10 | | | 324016 | 243037 | 334812 | 343348 553206 | 915415 SM1708 | 915400 SM9703 ¹⁾ SM9704 ²⁾ |
|--------------|----------|-------------|--|--|--------|--------|--------|------------------|------------------|--|

1) SM9703 : OE p/n = 1J0513353D 2) SM9704 : OE p/n = 1J0513353B

| MODEL FAHRZEUG MODELE | YEAR JAHR ANNEE | FRONT | REAR | FRONT | REAR | FRONT | REAR | FRONT | REAR |
|-----------------------------|-----------------------|-------|------|-------|------|-------|------|--------------------------------|------|
| | | | | | | | | PROTECTION KIT MOUNTING KIT | |

Volkswagen (D)

Passat, Santana (-88)

| | | | | | | | | | |
|--|--|--|--|----------------------|--|--------|-----------------------|------------------|-----------------------------|
| Passat (32B) Passat Variant Santana → 32D155757 Exc. | 11.80 - 3.83 3.81 - 83 82 - 3.83 | | | 375008 ¹⁾ | | 365500 | | 910088 SM1702 | 915408▼ 910087 SM5377 |
| (2WD) Passat (32B) Passat Variant Santana 32D155758 → Exc. | 4.83 - 3.88 | | | 375008 ¹⁾ | | 365500 | 343206 ^{2)▼} | 910088 SM1702 | 915408▼ 910087 SM5377 |
| Syncro (4WD) Exc. | 8.84 - 8.88 | | | 375008 ¹⁾ | | 365500 | 551063 | SM1702 | |
| (4WD) | 8.84 - 8.88 | | | 375008 ¹⁾ | | 365500 | 551063 | SM1702 | |

1)

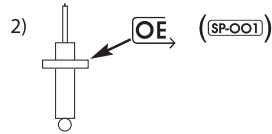

Passat (88 - 96)

| | | | | | | | | | |
|---|-----------------------------|--|--|--------|--|--------------------------------|----------------------|------------------|-----------------------------|
| (2WD) (3A2, 35I) Variant (3A5, 35I) Exc. 2.8 VR6, | 4.88 - 7.91 | | | 324025 | | 365502 ¹⁾ 334810 | 343223 ²⁾ | 915401 SM1700 | 915408▼ 910087 SM5197 |
| (2WD) (3A2, 35I) Variant (3A5, 35I) → P-026435 Exc. 2.8 VR6, | 8.91 - 92 | | | 324025 | | 334810 | 343223 ²⁾ | 915401 SM1700 | 915408▼ 910087 SM5197 |
| Syncro (4WD) 1.8 G60/2.0 (3A2, 35I) 1.8 G60/2.0 (3A5, 35I) Exc. | 9.89 - 7.91 10.90 - 7.91 | | | 324025 | | 365502 ¹⁾ 334810 | 551063 | SM1700 | |
| Syncro (4WD) 1.8 G60/2.0 (3A2, 35I) 1.8 G60/2.0 (3A5, 35I) → P-026435 Exc. | 8.91 - 92 | | | 324025 | | 334810 | 551063 | SM1700 | |
| Syncro (4WD) 1.8 G60/2.0 (3A2, 35I) 1.8 G60/2.0 (3A5, 35I) | 9.89 - 92 | | | 324025 | | 334810 | | 913147 | |

1)

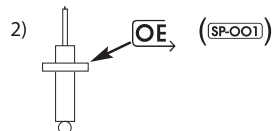

| MODEL FAHRZEUG MODELE | YEAR JAHR ANNEE | FRONT | REAR | FRONT | REAR | FRONT | REAR | FRONT | REAR |
|--|-----------------------|---------|------|--------|----------------------|--------|----------------------|--|----------------------|
| | | | | | | | | PROTECTION KIT MOUNTING KIT | |
| Volkswagen (D) | | | | | | | | | |
| Passat (3C2, 3C5) (05 -) | | | | | | | | | |
| (3C2, 3C5) Exc. Sport sus., 3.6, , | 3.05 - | | | 325700 | 354006 | 335808 | 344459 | 910059 SM1714 | 910056 SM9709 |
| Passat (362, 365) (10 -) | | | | | | | | | |
| (362) (365) Incl. , Sport sus., Blue-Motion Exc. , , | 8.10 - | | | 325700 | 354006 | 335808 | 344459 | 910059 ¹⁾ SM1714 | 910056 SM9709 |
| (365) Incl. , Sport sus. Exc. , , | 8.10 - | | | 325700 | 354006 | 335808 | 344459 | 910059 ¹⁾ SM1714 | 910056 SM9709 |
| (362, 365) 1.8 TFSi (112 kW) 2.0 TDi (125 kW) Incl. , Sport sus., Blue-Motion Exc. | 2.11 - 8.10 - | | | 325700 | | 335808 | | 910059 ¹⁾ SM1714 | |
| Alltrack (365) Exc. | 1.12 - | | | 325700 | | 335808 | 344004 ²⁾ | SM1714 | 910056 SM9709 |
| 1) Normal sus. 2) 3.12 → | | | | | | | | | |
| Polo, Derby | | | | | | | | | |
| Polo (Exc. G40) Derby | 75 - 94 7.76 - 86 | | | | 351004▼ | | 341023▼ | 915404 SM1703 | 915412 ²⁾ |
| (6N1) 1.0, 1.05, 1.3, 1.4, 1.6, 1.7 SDI, 1.9 D 1.9 SDI | 9.94 - 10.99 | 734039▼ | | 324025 | 353021 ¹⁾ | 333712 | 343274 ¹⁾ | 915401 ³⁾ 910084 ⁴⁾ SM1707 | 915418 SM9700 |
| (6N2) 1.0, 1.4, 1.4 TDI, 1.7 SDI, 1.9 D 1.9 SDI | 10.99 - 9.01 | 734039▼ | | 324025 | 353021 ¹⁾ | 333712 | 343274 ¹⁾ | 910084 SM1713 | 915418 SM9700 |
| (6N2) 1.6 GTi | 10.99 - 9.01 | | | | 353021 ¹⁾ | | 343274 ¹⁾ | 910084 SM1713 | 915418 SM9700 |
| Classic (6KV2) 1.4, 1.6, 1.7 SDI | 95 - 9.01 | 734039▼ | | 324025 | 353021 ¹⁾ | 333712 | 343274 ¹⁾ | 915401 ³⁾ 910084 ⁴⁾ SM1707 | 915419 SM9700 |
| Classic (6KV2) 1.8, 1.9 SDI, 1.9 TDI | 95 - 9.01 | 734039▼ | | 324025 | 353021 ¹⁾ | 334810 | 343274 ¹⁾ | 915401 ³⁾ 910084 ⁴⁾ SM1707 | 915419 SM9700 |
| 1) (SG-701) 2) 915412 = not for 341023, 351004 3) → 6KX610000 4) 6KX610000 → | | | | | | | | | |

| MODEL FAHRZEUG MODELE | YEAR JAHR ANNEE | FRONT | REAR | FRONT | REAR | FRONT | REAR | FRONT | REAR |
|-----------------------------|-----------------------|-------|------|-------|----------------|--------------|------|-------|------|
| | | | | | PROTECTION KIT | MOUNTING KIT | | | |

Volkswagen (D)

Polo , Polo Variant

| | | | | | | | | | | |
|-----------------------------------|-------------|-----------|--|--|--------|--|--------|----------------------|--------------------------------|------------------|
| 1.4, 1.6, 1.8 1.7 SDI, 1.9 SDI | (6KV5, 6NF) | 97 - 9.01 | | | 324025 | | 333712 | 343297 ¹⁾ | 910084 ²⁾ SM1713 | 915419 SM9700 |
| 1.9 D, 1.9 TDI | (6KV5, 6NF) | 97 - 9.01 | | | 324025 | | 334810 | 343297 ¹⁾ | 910084 ²⁾ SM1704 | 915419 SM9700 |

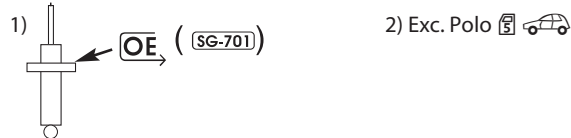

Polo (9N, 9A4)

| | | | | | | | | | | |
|---|--|---------------|--|--|--------|--------|--------|--------|------------------|------------------|
| (9N, 9A4) Exc. Sport sus., , Cup Edition | | 10.01 - 11.09 | | | 324702 | 353025 | 334835 | 343328 | 910084 SM1713 | 915400 SM9704 |
|---|--|---------------|--|--|--------|--------|--------|--------|------------------|------------------|

Scirocco

| | | | | | | | | | | |
|--|-----------|---------|--|--|----------------------|--------|----------------------|--------|------------------|--|
| (53, 53B) Exc. GTI, GLI, GTX | | 74 - 92 | | | 373012 | 351007 | 363001 | 341007 | 910088 SM5508 | |
| GTI, GLI, GTX Exc. 16V | (53, 53B) | 74 - 92 | | | 373012 | 351007 | 363001 | 341007 | 910088 SM5508 | |
| 1.4 TSi, 2.0 TSi, 2.0 TDi Exc. Sport sus. | (137) | 5.08 - | | | 325700 ¹⁾ | 354006 | 335808 ¹⁾ | 344459 | 910059 SM1714 | 915400 SM9707 ²⁾ SM9709 ³⁾ |

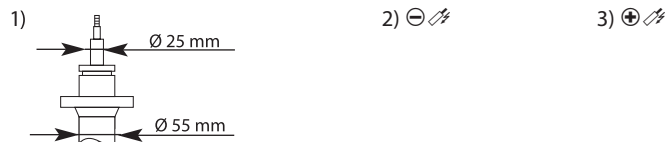

Touran

| | | | | | | | | | | |
|--------------------------------|--|-------------|--|--|--------|--------|--------|--------|--|--|
| (1T1, 1T2) Exc. Sport sus., | | 2.03 - 5.10 | | | 325700 | 354006 | 335808 | 344459 | 910004 SM1714 | 910056 ¹⁾ 910045 ²⁾ SM9709 ¹⁾ SM9708 ²⁾ |
| (1T3) Incl. Sport sus., | | 5.10 - | | | 325700 | 354006 | 335808 | 344459 | 910004 ³⁾ 910177 ⁴⁾ 910059 ⁵⁾ SM1714 | 910056 ¹⁾ SM9709 ¹⁾ |

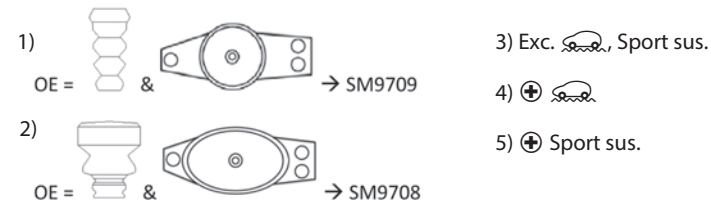

Volkswagen Commercial (D)

Polo Caddy

| | | | | | | | | | | |
|---|------|------|--|--|--------|--|--------|--------|--------|--|
| 1.4, 1.6, 1.7 SDI 1.9 SD, 1.9 SDI 1.9 TDI (42 kW, 66 kW) 1.9 D | (9K) | 96 - | | | 324025 | | 333712 | 553231 | SM1704 | |
|---|------|------|--|--|--------|--|--------|--------|--------|--|

NUMERICAL LISTING
 NUMERISCHE LISTE
 LISTE NUMERIQUE

Numerical List

| KYB | VEHICLE FAHRZEUG VEHICULE | KYB | VEHICLE FAHRZEUG VEHICULE |
|--|--|------------|--|
| Excel-G Sealed Strut (23/33 - Series) | | | |
| 234000 Series | | | |
| 234901 | Chrysler Neon - R | 332011 | Nissan Sunny, Sunny Traveller / Q-bic - F(L) |
| 234902 | Chrysler Neon - F | 332012 | Toyota Corolla & Sprinter - R(R) |
| 235626 | Chrysler PT-Cruiser - F | 332021▼ | Toyota Corolla & Sprinter - R(L) |
| 235627 | Chrysler Neon - F | 332026 | Toyota Corolla & Sprinter - R |
| 235628 | Chrysler Neon - R(R) | | Nissan Cherry, Pulsar - R(R) |
| 235629 | Chrysler Neon - R(L) | | Nissan Sunny - R(R) |
| 235901 | Chrysler Voyager / Mini-Van, Town & Country, Caravan - F | 332027 | Nissan Sunny, Sunny Traveller / Q-bic - R(R) |
| 235902 | Chrysler Le Baron, Saratoga - F | | Nissan Cherry, Pulsar - R(L) |
| 331000 Series | | | |
| 331002▼ | Renault R 21, R 21 Nevada, Société - F | | Nissan Sunny - R(L) |
| 331003 | Nissan Silvia, 200 SX - F(R) | 332028 | Nissan Sunny, Sunny Traveller / Q-bic - R(L) |
| 331005 | Nissan Silvia, 200 SX - F(L) | | Nissan Cherry, Pulsar - F(R) |
| 331008 | Honda Civic - F(R) | | Nissan Sunny - F(R) |
| 331009 | Honda Civic - F(L) | 332029 | Nissan Sunny, Sunny Traveller / Q-bic - F(R) |
| 331010 | Honda Civic - F(R) | | Nissan Cherry, Pulsar - F(L) |
| 331011 | Honda Civic - F(L) | | Nissan Sunny - F(L) |
| 331012 | Honda Stream - F(R) | 332043 | Nissan Sunny, Sunny Traveller / Q-bic - F(L) |
| 331013 | Honda Stream - F(L) | | Daihatsu Charade - F(R) |
| 331014 | Nissan Primera - F(R) | 332044 | Daihatsu Charade - F(L) |
| 331015 | Nissan Primera - F(L) | 332049 | Suzuki Swift - F(R) |
| 331017 | Jeep Cherokee, Wagoneer - F | 332050 | Suzuki Swift - F(L) |
| | Jeep Grand Cherokee, Grand Wagoneer - F | 332051 | Suzuki Swift - R |
| | Jeep Liberty - F | 332052 | Suzuki Swift - F(R) |
| 331018 | Toyota Celica - F(R) | 332053 | Suzuki Swift - F(L) |
| 331019 | Toyota Celica - F(L) | 332054 | Kia Pride - F(R) |
| 331044 | Honda CR-V - F(R) | | Mazda 121 - F(R) |
| 331045 | Honda CR-V - F(L) | 332055 | Kia Pride - F(L) |
| 331046 | Honda Element - F(R) | | Mazda 121 - F(L) |
| 331047 | Honda Element - F(L) | 332056 | Nissan 100 NX - R(R) |
| 331048 | Honda CR-V - F(R) | | Nissan Sunny - R(R) |
| 331049 | Honda CR-V - F(L) | 332057 | Nissan 100 NX - R(L) |
| 331050 | Honda CR-V - F(R) | | Nissan Sunny - R(L) |
| 331051 | Honda CR-V - F(L) | 332058 | Nissan Sunny - R(R) |
| 331603 | Auto Bianchi Y 10 - F(R) | 332059 | Nissan Sunny - R(L) |
| | Lancia Y10 - F(R) | 332061 | Nissan Micra, March - F(R) |
| 331604 | Auto Bianchi Y 10 - F(L) | 332062 | Nissan Micra, March - F(L) |
| | Lancia Y10 - F(L) | 332063 | Nissan Primera Traveller - F(R) |
| 331700 | Mercedes Benz Sprinter II - F | 332064 | Nissan Primera Traveller - F(L) |
| 331701 | Mercedes Benz Sprinter II - F | 332066▼ | Daihatsu Charade - R(R) |
| | Mercedes Benz Sprinter III (B907, B910) - F | 332067▼ | Daihatsu Charade - R(L) |
| | Volkswagen Crafter - F | 332068 | Mazda 121 - F(R) |
| 331702 | Mercedes Benz Sprinter II - F | 332069 | Mazda 121 - F(L) |
| | Mercedes Benz Sprinter III (B907, B910) - F | 332078▼ | Daihatsu Charade - F(R) |
| | Volkswagen Crafter - F | 332079▼ | Daihatsu Charade - F(L) |
| 3310000 Series | | | |
| 3318000 | Audi Q7 (4MB, 4MG) - F | 332080 | Hyundai Accent, Pony, Excel - R(R) |
| 332000 Series | | | |
| 332004 | Ford Fiesta Van, Courier - R | 332081 | Hyundai Accent, Pony, Excel - R(L) |
| | Ford Fiesta, XR-2 - R | 332082 | Subaru Vivio - F(R) |
| 332007 | Nissan Sunny - F(R) | 332083 | Subaru Vivio - F(L) |
| | Nissan Sunny, Sunny Traveller / Q-bic - F(R) | 332086 | Subaru Vivio - R(R) |
| 332008 | Nissan Sunny - F(L) | 332087 | Subaru Vivio - R(L) |
| | | 332088 | Toyota Corolla - R(R) |
| | | 332089 | Toyota Corolla - R(L) |
| | | 332092 | Suzuki Wagon R+ - F(R) |
| | | 332093 | Suzuki Wagon R+ - F(L) |
| | | 332094 | Hyundai Accent, Pony, Excel - R(R) |
| | | 332095 | Hyundai Accent, Pony, Excel - R(L) |
| | | 332100 | Chevrolet - Daewoo Matiz (UzDaewoo) - F(R) |
| | | | Chevrolet - Daewoo Matiz / Spark - F(R) |



NUMERICAL LISTING
 NUMERISCHE LISTE
 LISTE NUMERIQUE

| KYB | VEHICLE FAHRZEUG VEHICULE | KYB | VEHICLE FAHRZEUG VEHICULE |
|------------|--|-----------------------|--|
| 332101 | Chevrolet - Daewoo Matiz (UzDaewoo) - F(L) | | Toyota Aygo - F(L) |
| 332102 | Chevrolet - Daewoo Matiz / Spark - F(L) | 332900 | Smart Cabrio - F |
| | Daihatsu Cuore / Domino - F(R) | | Smart City-Coupé - F |
| | Daihatsu Move - F(R) | 332901 | Smart Cabrio - F |
| 332103 | Daihatsu Cuore / Domino - F(L) | | Smart City-Coupé - F |
| | Daihatsu Move - F(L) | | Smart Cross-blade - F |
| 332104 | Daihatsu Sirion / Storia - F(R) | | Smart Fortwo Coupé , Fortwo Cabrio - F |
| 332105 | Daihatsu Sirion / Storia - F(L) | | Smart Roadster - F |
| 332106 | Honda Logo - F(R) | | Smart Roadster Coupé - F |
| 332107 | Honda Logo - F(L) | | |
| 332108 | Hyundai Accent, Pony, Excel - R(R) | 3320000 Series | |
| 332109 | Hyundai Accent, Pony, Excel - R(L) | 3320014 | Mitsubishi Mirage / Space Star VI (A0_A) - F |
| 332110 | Daihatsu Sirion / Storia - F(R) | 3320020 | Kia Picanto - F(R) |
| | Daihatsu YRV - F(R) | 3320021 | Kia Picanto - F(L) |
| 332111 | Daihatsu Sirion / Storia - F(L) | 3320022 | Suzuki Celerio (LF) - F(R) |
| | Daihatsu YRV - F(L) | 3320023 | Suzuki Celerio (LF) - F(L) |
| 332112 | Mitsubishi Colt - F(R) | 3320035 | Chevrolet - Daewoo Matiz / Spark (M200, M250) - F(R) |
| 332113 | Mitsubishi Colt - F(L) | 3320036 | Chevrolet - Daewoo Matiz / Spark (M200, M250) - F(L) |
| 332118 | Daihatsu Cuore / Domino - F(R) | 333000 Series | |
| 332119 | Daihatsu Cuore / Domino - F(L) | 333002▼ | Toyota Carina II - R(R) |
| 332120 | Daihatsu Sirion / Storia - F | 333003▼ | Toyota Carina II - R(L) |
| | Subaru Justy - F | 333011▼ | Toyota Camry - R(R) |
| 332137 | Daihatsu Cuore / Domino - F(R) | 333012▼ | Toyota Camry - R(L) |
| 332138 | Daihatsu Cuore / Domino - F(L) | 333021 | Austin-Rover Triumph - F |
| 332139 | Daihatsu Trevis - F(R) | | Honda Civic, Ballade - F |
| 332140 | Daihatsu Trevis - F(L) | | Honda Quintet - F |
| 332148 | Nissan Micra, March - F(R) | 333025▼ | Mazda 323 - F(R) |
| | Nissan Note - F(R) | 333026▼ | Mazda 323 - F(L) |
| 332149 | Nissan Micra, March - F(L) | 333044 | Ford Fiesta, XR-2 - F |
| | Nissan Note - F(L) | 333051 | Toyota Corolla - R(R) |
| 332154 | Nissan Pixo - F(R) | 333052 | Toyota Corolla - R(L) |
| | Suzuki Alto - F(R) | 333053▼ | Nissan Cherry, Pulsar - R(R) |
| 332155 | Nissan Pixo - F(L) | | Nissan Sunny - R(R) |
| | Suzuki Alto - F(L) | | Nissan Sunny, Sunny Traveller / Q-bic - R(R) |
| 332500 | Kia Picanto - F(R) | 333054▼ | Nissan Cherry, Pulsar - R(L) |
| 332501 | Kia Picanto - F(L) | | Nissan Sunny - R(L) |
| 332502 | Hyundai i10 - F(R) | | Nissan Sunny, Sunny Traveller / Q-bic - R(L) |
| 332503 | Hyundai i10 - F(L) | 333061 | Renault R 5 (Super 5) - F |
| 332504▼ | Chevrolet - Daewoo Matiz / Spark - F(R) | 333067 | Toyota Starlet - F(R) |
| 332505▼ | Chevrolet - Daewoo Matiz / Spark - F(L) | 333068 | Toyota Starlet - F(L) |
| 332801▼ | Ford Escort Mk. III, IV, XR-3 - R | 333072▼ | Mazda 323 - R(R) |
| | Ford Orion - R | 333073▼ | Mazda 323 - R(L) |
| 332803 | Subaru Justy, J Series - F(R) | 333079 | Ford Escort Mk. III, IV, XR-3 - R |
| | Suzuki Ignis - F(R) | | Ford Orion - R |
| 332804 | Subaru Justy, J Series - F(L) | | Nissan 100 NX - F(R) |
| | Suzuki Ignis - F(L) | 333089 | Nissan Sunny - F(R) |
| 332805 | Suzuki Ignis - F(R) | | Nissan Sunny, Sunny Traveller / Q-bic - F(R) |
| 332806 | Suzuki Ignis - F(L) | 333090 | Nissan 100 NX - F(L) |
| 332807 | Citroën C1 - F(R) | | Nissan Sunny - F(L) |
| | Citroën C1 II - F(R) | | Nissan Sunny, Sunny Traveller / Q-bic - F(L) |
| | Peugeot 107 - F(R) | 333091▼ | Nissan Sunny - F(R) |
| | Peugeot 108 - F(R) | | Nissan Sunny, Sunny Traveller / Q-bic - F(R) |
| | Toyota Aygo - F(R) | 333092▼ | Nissan Sunny - F(L) |
| 332808 | Citroën C1 - F(L) | | Nissan Sunny, Sunny Traveller / Q-bic - F(L) |
| | Citroën C1 II - F(L) | 333100▼ | Volvo 400 Series - F(R) |
| | Peugeot 107 - F(L) | 333101▼ | Volvo 400 Series - F(L) |
| | Peugeot 108 - F(L) | | |



Numerical List

NUMERICAL LISTING
 NUMERISCHE LISTE
 LISTE NUMERIQUE

Numerical List



| KYB | VEHICLE FAHRZEUG VEHICULE | KYB | VEHICLE FAHRZEUG VEHICULE |
|------------|--|------------|---|
| 333102 | Volvo 400 Series - F | 333185 | Mazda 323 C, 323 S - R(L) |
| 333107 | Toyota Carina - R(R) | | Mazda 323 F - R(L) |
| 333108 | Toyota Carina - R(L) | 333192 | Nissan Almera (N15) - F(R) |
| 333112 | Toyota Carina - R(R) | 333193 | Nissan Almera (N15) - F(L) |
| 333113 | Toyota Carina - R(L) | 333194 | Subaru Justy, J Series - F(R) |
| 333114 | Toyota Corolla - F(R) | | Suzuki Swift - F(R) |
| 333115 | Toyota Corolla - F(L) | 333195 | Subaru Justy, J Series - F(L) |
| 333116 | Toyota Corolla - R(R) | | Suzuki Swift - F(L) |
| 333117 | Toyota Corolla - R(L) | 333196 | Subaru Justy, J Series - R |
| 333118 | Toyota Corolla - F(R) | | Suzuki Swift - R |
| 333119 | Toyota Corolla - F(L) | 333197 | Toyota Carina - F(R) |
| 333122▼ | Mitsubishi Lancer Estate - F(R) | 333198 | Toyota Carina - F(L) |
| 333123▼ | Mitsubishi Lancer Estate - F(L) | 333199▼ | Daihatsu Charade - R(R) |
| 333124 | Mitsubishi Colt - F(R) | 333200▼ | Daihatsu Charade - R(L) |
| | Mitsubishi Lancer - F(R) | 333205 | Hyundai Coupé - F(R) |
| | Mitsubishi Lancer Estate - F(R) | | Hyundai Elantra - F(R) |
| | Proton Persona, 400 Series, Wira - F(R) | | Hyundai Lantra - F(R) |
| 333125 | Mitsubishi Colt - F(L) | 333206 | Hyundai Coupé - F(L) |
| | Mitsubishi Lancer - F(L) | | Hyundai Elantra - F(L) |
| | Mitsubishi Lancer Estate - F(L) | | Hyundai Lantra - F(L) |
| | Proton Persona, 400 Series, Wira - F(L) | 333207 | Hyundai Coupé - R(R) |
| 333126 | Mazda 323 - F(R) | | Hyundai Lantra - R(R) |
| 333127 | Mazda 323 - F(L) | 333208 | Hyundai Coupé - R(L) |
| 333130 | Mazda 323 F - F(R) | | Hyundai Lantra - R(L) |
| 333131 | Mazda 323 F - F(L) | 333209 | Toyota Paseo - F(R) |
| 333132 | Mazda 323 - R(R) | | Toyota Starlet - F(R) |
| | Mazda 323 F - R(R) | 333210 | Toyota Paseo - F(L) |
| 333133 | Mazda 323 - R(L) | | Toyota Starlet - F(L) |
| | Mazda 323 F - R(L) | 333211 | Hyundai Accent, Pony, Excel - F(R) |
| 333145▼ | GM Century, Special, Celebrity - F | 333212 | Hyundai Accent, Pony, Excel - F(L) |
| | GM Lumina APV Mini Van, Trans Sport Mini Van - F | 333215 | Suzuki Baleno - R(R) |
| 333156 | Hyundai Pony, Excel - F | 333216 | Suzuki Baleno - R(L) |
| | Hyundai S-Coupé - F | 333221 | Mitsubishi Carisma - F(R) |
| 333170▼ | Daihatsu Applause - F(R) | 333222 | Mitsubishi Carisma - F(L) |
| 333171▼ | Daihatsu Applause - F(L) | 333224 | Mitsubishi Colt - F(R) |
| 333172 | Daihatsu Applause - R(R) | | Mitsubishi Lancer - F(R) |
| 333173 | Daihatsu Applause - R(L) | | Proton Persona Compact, 300 Series - F(R) |
| 333176▼ | Honda Prelude - R(R) | | Proton Persona, 400 Series, Wira - F(R) |
| 333177▼ | Honda Prelude - R(L) | 333225 | Mitsubishi Colt - F(L) |
| 333178 | Mazda 323 C, 323 S - F(R) | | Mitsubishi Lancer - F(L) |
| | Mazda 323 F - F(R) | | Proton Persona Compact, 300 Series - F(L) |
| | Mazda 323 P - F(R) | | Proton Persona, 400 Series, Wira - F(L) |
| 333179 | Mazda 323 C, 323 S - F(L) | 333236 | Toyota Corolla - F(R) |
| | Mazda 323 F - F(L) | 333237 | Toyota Corolla - F(L) |
| | Mazda 323 P - F(L) | 333238 | Nissan Almera (N15) - F(R) |
| 333180 | Mazda 323 C, 323 S - R(R) | 333239 | Nissan Almera (N15) - F(L) |
| | Mazda 323 F - R(R) | 333244 | Daihatsu Charade - F(R) |
| | Mazda 323 P - R(R) | | Daihatsu Gran Move - F(R) |
| 333181 | Mazda 323 C, 323 S - R(L) | 333245 | Daihatsu Charade - F(L) |
| | Mazda 323 F - R(L) | | Daihatsu Gran Move - F(L) |
| | Mazda 323 P - R(L) | 333246 | Daihatsu Charade - R(R) |
| 333182 | Mazda 323 C, 323 S - F(R) | | Daihatsu Gran Move - R(R) |
| | Mazda 323 F - F(R) | 333247 | Daihatsu Charade - R(L) |
| 333183 | Mazda 323 C, 323 S - F(L) | | Daihatsu Gran Move - R(L) |
| | Mazda 323 F - F(L) | 333248 | Daihatsu Move - F(R) |
| 333184 | Mazda 323 C, 323 S - R(R) | 333249 | Daihatsu Move - F(L) |
| | Mazda 323 F - R(R) | 333250 | Mazda MX-3 - F(R) |

NUMERICAL LISTING
 NUMERISCHE LISTE
 LISTE NUMERIQUE



|  | VEHICLE FAHRZEUG VEHICULE |  | VEHICLE FAHRZEUG VEHICULE | |
|---|-------------------------------------|---|---------------------------------|------------------------------|
| 333251 | Mazda MX-3 - F(L) | 333313 | Suzuki Baleno - F(L) | |
| 333252 | Mazda MX-3 - R(R) | 333314 | Kia Carens - F(R) | |
| 333253 | Mazda MX-3 - R(L) | | Kia Shuma, Spectra - F(R) | |
| 333254 | Chevrolet - Daewoo Nubira - R(R) | 333315 | Kia Carens - F(L) | |
| | Chevrolet - Daewoo Nubira II - R(R) | | Kia Shuma, Spectra - F(L) | |
| 333255 | Chevrolet - Daewoo Nubira - R(L) | 333316 | Kia Shuma, Spectra - F(R) | |
| | Chevrolet - Daewoo Nubira II - R(L) | 333317 | Kia Shuma, Spectra - F(L) | |
| 333256 | Hyundai Atos - F(R) | 333318 | Mitsubishi Colt - F(R) | |
| 333257 | Hyundai Atos - F(L) | 333319 | Mitsubishi Colt - F(L) | |
| 333262 | Kia Shuma, Spectra - F(R) | 333320 | Toyota MR 2 III - F(R) | |
| 333263 | Kia Shuma, Spectra - F(L) | 333321 | Toyota MR 2 III - F(L) | |
| 333264 | Kia Carens - R(R) | 333322 | Nissan Almera Tino (V10) - F(R) | |
| | Kia Shuma, Spectra - R(R) | 333323 | Nissan Almera Tino (V10) - F(L) | |
| 333265 | Kia Carens - R(L) | 333326 | Nissan Almera Tino (V10) - F(R) | |
| | Kia Shuma, Spectra - R(L) | 333327 | Nissan Almera Tino (V10) - F(L) | |
| 333266 | Mazda Demio - F(R) | 333331 | Honda Jazz - F(R) | |
| 333267 | Mazda Demio - F(L) | 333332 | Honda Jazz - F(L) | |
| 333268 | Mazda Premacy - F(R) | 333346 | Suzuki Ignis - F(R) | |
| 333269 | Mazda Premacy - F(L) | 333347 | Suzuki Ignis - F(L) | |
| 333274 | Mazda 323 F - F(R) | 333350 | Mazda 323 F - F(R) | |
| | Mazda 323 S - F(R) | | Mazda 323 S - F(R) | |
| 333275 | Mazda 323 F - F(L) | | Mazda Premacy - F(R) | |
| | Mazda 323 S - F(L) | 333351 | Mazda 323 F - F(L) | |
| 333276 | Mazda 323 F - R(R) | | Mazda 323 S - F(L) | |
| | Mazda 323 S - R(R) | | Mazda Premacy - F(L) | |
| 333277 | Mazda 323 F - R(L) | | 333354 | Suzuki Liana - F(R) |
| | Mazda 323 S - R(L) | | 333355 | Suzuki Liana - F(L) |
| 333278 | Toyota Yaris Verso - F | | 333356 | Suzuki Liana - R(R) |
| 333280 | Mitsubishi Space Star - F(R) | | 333357 | Suzuki Liana - R(L) |
| 333281 | Mitsubishi Space Star - F(L) | | 333358 | Toyota Corolla - F(R) |
| 333282 | Nissan Primera - R(R) | | | Toyota Corolla Verso - F(R) |
| 333283 | Nissan Primera - R(L) | | 333359 | Toyota Corolla - F(L) |
| 333286 | Toyota Corolla - R(R) | | | Toyota Corolla Verso - F(L) |
| 333287 | Toyota Corolla - R(L) | | 333360 | Toyota Prius (Hybrid) - F(R) |
| 333298 | Hyundai Atos - F(R) | | 333361 | Toyota Prius (Hybrid) - F(L) |
| | Hyundai Atos Prime / Amica - F(R) | | 333364 | Kia Shuma, Spectra - R(R) |
| 333299 | Hyundai Atos - F(L) | | 333365 | Kia Shuma, Spectra - R(L) |
| | Hyundai Atos Prime / Amica - F(L) | | 333366 | Hyundai Matrix - F(R) |
| 333304 | Hyundai Accent, Pony, Excel - F(R) | | 333367 | Hyundai Matrix - F(L) |
| 333305 | Hyundai Accent, Pony, Excel - F(L) | | 333368 | Toyota Yaris I - F |
| 333306 | Opel Agila - F(R) | | 333369▼ | Kia Sephia I - F(R) |
| | Suzuki Wagon R+ - F(R) | | 333370▼ | Kia Sephia I - F(L) |
| | Vauxhall Agila - F(R) | | 333371▼ | Kia Sephia I - R(R) |
| 333307 | Opel Agila - F(L) | | 333372▼ | Kia Sephia I - R(L) |
| | Suzuki Wagon R+ - F(L) | | 333379 | Ford Fusion - F(R) |
| | Vauxhall Agila - F(L) | | 333380 | Ford Fusion - F(L) |
| 333308 | Nissan Almera (N16) - F(R) | | 333383 | Ford Fiesta V - F(R) |
| | Nissan Almera (N16E) - F(R) | | | Mazda Mazda 2, Demio - F(R) |
| 333309 | Nissan Almera (N16) - F(L) | | 333384 | Ford Fiesta V - F(L) |
| | Nissan Almera (N16E) - F(L) | | | Mazda Mazda 2, Demio - F(L) |
| 333310 | Nissan Almera (N16) - F(R) | | 333388 | Toyota Prius (Hybrid) - F(R) |
| | Nissan Almera (N16E) - F(R) | | 333389 | Toyota Prius (Hybrid) - F(L) |
| | Nissan Almera Classic - F(R) | | 333390 | Nissan Tiida - F(R) |
| 333311 | Nissan Almera (N16) - F(L) | | 333391 | Nissan Tiida - F(L) |
| | Nissan Almera (N16E) - F(L) | | 333398 | Ford Fusion - F(R) |
| | Nissan Almera Classic - F(L) | | 333399 | Ford Fusion - F(L) |
| 333312 | Suzuki Baleno - F(R) | | | |

NUMERICAL LISTING
 NUMERISCHE LISTE
 LISTE NUMERIQUE

Numerical List

|  | VEHICLE FAHRZEUG VEHICULE |  | VEHICLE FAHRZEUG VEHICULE |
|--|--|---|--|
| 333400 | Ford Fiesta V - F(R) | | Mazda 121 - F |
| | Mazda Mazda 2, Demio - F(R) | 333704 | Ford Fiesta IV - F |
| 333401 | Ford Fiesta V - F(L) | | Ford Fiesta Van, Courier - F |
| | Mazda Mazda 2, Demio - F(L) | | Mazda 121 - F |
| 333408 | Opel Agila - F(R) | 333706 | Renault Clio I - F |
| | Suzuki Splash - F(R) | 333707 | Renault Clio II - F |
| | Suzuki Swift III - F(R) | | Renault Thalia II, Symbol II (LU1/2_) - F |
| | Vauxhall Agila - F(R) | | Renault Thalia, Symbol - F |
| 333409 | Opel Agila - F(L) | 333708 | Renault Clio II - F |
| | Suzuki Splash - F(L) | | Renault Thalia, Symbol - F |
| | Suzuki Swift III - F(L) | 333709 | Ford Focus - F(R) |
| | Vauxhall Agila - F(L) | 333710 | Ford Focus - F(L) |
| 333410 | Honda Jazz - F(R) | 333712 | Seat Arosa - F |
| 333411 | Honda Jazz - F(L) | | Seat Cordoba Vario - F |
| 333417 | Chevrolet - Daewoo Kalos / Aveo - F(R) | | Seat Ibiza, Cordoba - F |
| 333418 | Chevrolet - Daewoo Kalos / Aveo - F(L) | | Seat Inca - F |
| 333419 | Chevrolet - Daewoo Lacetti / Optra / Gentra - R(R) | | Seat Toledo I - F |
| | Chevrolet - Daewoo Nubira III - R(R) | | Volkswagen Golf II, Jetta II - F |
| 333420 | Chevrolet - Daewoo Lacetti / Optra / Gentra - R(L) | | Volkswagen Golf III Variant - F |
| | Chevrolet - Daewoo Nubira III - R(L) | | Volkswagen Golf III, Vento , Jetta III - F |
| 333431 | Suzuki Liana - F(R) | | Volkswagen Lupo - F |
| 333432 | Suzuki Liana - F(L) | | Volkswagen Polo Caddy - F |
| 333433 | Daihatsu Terios - F(R) | | Volkswagen Polo, Derby - F |
| 333434 | Daihatsu Terios - F(L) | | Volkswagen Polo, Polo Variant - F |
| 333490 | Kia Cerato I - F(R) | 333713 | Seat Leon I - F |
| 333491 | Kia Cerato I - F(L) | | Seat Toledo II - F |
| 333492 | Kia Cerato I - R(R) | | Skoda Octavia I - F |
| 333493 | Kia Cerato I - R(L) | | Skoda Octavia I Combi - F |
| 333494 | Mazda Mazda 2, Demio - F(R) | | Volkswagen Bora Variant - F |
| 333495 | Mazda Mazda 2, Demio - F(L) | | Volkswagen Bora, Jetta IV - F |
| 333496 | Daihatsu Terios II - F | | Volkswagen Golf IV - F |
| 333502 | Kia Rio - F(R) | | Volkswagen Golf IV Variant - F |
| 333503 | Kia Rio - F(L) | 333714 | Renault Twingo - F |
| 333504▼ | Hyundai Matrix - R(R) | 333715 | Opel Vectra B - F(R) |
| 333505▼ | Hyundai Matrix - R(L) | | Vauxhall Vectra B - F(R) |
| 333506 | Hyundai Getz - F(R) | 333716 | Opel Vectra B - F(L) |
| 333507 | Hyundai Getz - F(L) | | Vauxhall Vectra B - F(L) |
| 333508 | Hyundai Coupé - F(R) | 333717 | Renault Laguna II - F |
| 333509 | Hyundai Coupé - F(L) | 333718 | Renault Mégane II - F |
| 333510 | Hyundai Coupé - R(R) | | Renault Mégane II Grandtour - F |
| 333511 | Hyundai Coupé - R(L) | 333721 | Nissan Micra, March - F(R) |
| 333512 | Kia Rio - F(R) | 333722 | Nissan Micra, March - F(L) |
| 333513 | Kia Rio - F(L) | 333723 | Renault Twingo - F(R) |
| 333516▼ | Hyundai Accent, Pony, Excel - F(R) | 333724 | Renault Twingo - F(L) |
| | Kia Rio II - F(R) | 333727 | Peugeot 406 - F(R) |
| 333517▼ | Hyundai Accent, Pony, Excel - F(L) | 333728 | Peugeot 406 - F(L) |
| | Kia Rio II - F(L) | 333729 | Citroën Berlingo - F(R) |
| 333614 | Mercedes Benz A-Class - F | | Peugeot 206 - F(R) |
| 333700 | Ford Ka, Sport Ka, Street Ka - F | | Peugeot 206 + - F(R) |
| 333701 | Ford Fiesta IV - F | | Peugeot 206 CC - F(R) |
| | Ford Fiesta Van, Courier - F | | Peugeot 206 SW - F(R) |
| | Mazda 121 - F | | Peugeot Partner, Ranch - F(R) |
| 333702 | Ford Fiesta IV - F | 333730 | Citroën Berlingo - F(L) |
| | Ford Fiesta Van, Courier - F | | Peugeot 206 - F(L) |
| | Mazda 121 - F | | Peugeot 206 + - F(L) |
| 333703 | Ford Fiesta IV - F | | Peugeot 206 CC - F(L) |
| | Ford Fiesta Van, Courier - F | | Peugeot 206 SW - F(L) |

NUMERICAL LISTING
 NUMERISCHE LISTE
 LISTE NUMERIQUE

|  | VEHICLE FAHRZEUG VEHICULE |  | VEHICLE FAHRZEUG VEHICULE |
|---|---|---|---|
| 333731 | Peugeot Partner, Ranch - F(L) Fiat Cinquecento (170) - F Fiat Seicento Van (187) - F | 333760 | Ford Ka, Sport Ka, Street Ka - F(L) |
| 333732 | Citroën Xsara (N1/N0) - F(R) Citroën Xsara (N2) - F(R) | 333761 | Ford Ka, Sport Ka, Street Ka - F(R) |
| 333733 | Citroën Xsara (N1/N0) - F(L) Citroën Xsara (N2) - F(L) | 333762 | Ford Ka, Sport Ka, Street Ka - F(L) |
| 333734 | Citroën Xsara (N1/N0) - F(R) Citroën Xsara (N2) - F(R) | 333763 | Fiat Panda (169) - F(R) |
| 333735 | Citroën Xsara (N1/N0) - F(L) Citroën Xsara (N2) - F(L) | 333764 | Fiat Panda (169) - F(L) |
| 333736 | Citroën Xsara Picasso - F(R) | 333766 | Fiat 500, 500 C - F(R) |
| 333737 | Citroën Xsara Picasso - F(L) | 333767 | Fiat 500, 500 C - F(L) |
| 333740 | Renault Modus - F | 333768 | Peugeot 308 I - F(R) Peugeot 308 SW I - F(R) |
| 333742 | Renault Thalia, Symbol - F | 333769 | Peugeot 308 I - F(L) Peugeot 308 SW I - F(L) |
| 333743 | Renault Thalia II, Symbol II (LU1/2_) - F | 333770 | Peugeot 308 I - F(R) Peugeot 308 SW I - F(R) |
| 333744 | Renault Thalia, Symbol - F Renault Clio Grandtour - F Renault Clio III - F | 333771 | Peugeot 308 I - F(L) Peugeot 308 SW I - F(L) |
| 333745 | Toyota Yaris II - F(R) Toyota Yaris III - F(R) | 333772 | Citroën C4 Picasso, C4 Grand Picasso I - F(R) Peugeot 308 CC - F(R) Peugeot 308 SW I - F(R) |
| 333746 | Toyota Yaris II - F(L) Toyota Yaris III - F(L) | 333773 | Citroën C4 Picasso, C4 Grand Picasso I - F(L) Peugeot 308 CC - F(L) Peugeot 308 SW I - F(L) |
| 333747 | Nissan Note - F(R) | 333774 | Ford Ka, Sport Ka, Street Ka - F(R) |
| 333748 | Nissan Note - F(L) | 333775 | Ford Ka, Sport Ka, Street Ka - F(L) |
| 333749 | Fiat Bravo, Brava (182) - F Fiat Tempra (159) - F Fiat Tempra Station Wagon / Familia (159) - F Fiat Tipo (160) - F | 333776 | Citroën C3 Picasso - F(R) |
| 333750 | Fiat Bravo, Brava (182) - F | 333777 | Citroën C3 Picasso - F(L) |
| 333751 | Fiat Sedici - F(R) Suzuki SX4 - F(R) | 333781 | Hyundai Elantra - R(R) |
| 333752 | Fiat Sedici - F(L) Suzuki SX4 - F(L) | 333782 | Hyundai Elantra - R(L) |
| 333753 | Fiat Sedici - F(R) Suzuki SX4 - F(R) | 333802 | Ford Escort Mk. III, IV, XR-3 - F Ford Orion - F |
| 333754 | Fiat Sedici - F(L) Suzuki SX4 - F(L) | 333803 | Ford Fiesta Van, Courier - F Ford Fiesta, XR-2 - F |
| 333755 | Opel Combo - F(R) Opel Corsa C - F(R) Opel Meriva - F(R) Opel Tigra Twintop - F(R) Vauxhall Combo - F(R) Vauxhall Corsa C - F(R) Vauxhall Meriva - F(R) | 333804▼ | Renault R 5 (Super 5) - F |
| 333756 | Opel Combo - F(L) Opel Corsa C - F(L) Opel Meriva - F(L) Opel Tigra Twintop - F(L) Vauxhall Combo - F(L) Vauxhall Corsa C - F(L) Vauxhall Meriva - F(L) | 333805 | Renault R 5 (Super 5) - F |
| 333757 | Citroën C4 - F(R) Peugeot 307, 307 SW, 307 CC - F(R) | 333806 | Renault R 5 (Super 5) Express, Rapide, Extra - F |
| 333758 | Citroën C4 - F(L) Peugeot 307, 307 SW, 307 CC - F(L) | 333807▼ | Renault R 9, R 11 - F |
| 333759 | Ford Ka, Sport Ka, Street Ka - F(R) | 333808 | Renault R 19 / Chamade - F |
| | | 333814▼ | Seat Ibiza, Cordoba - R Seat Malaga - R Seat Ronda - R |
| | | 333815 | Fiat Ritmo / Strada (138) - R Seat Ibiza, Cordoba - R Seat Malaga - R |
| | | 333817 | Ford Fiesta Van, Courier - F Ford Fiesta, XR-2 - F |
| | | 333818▼ | Ford Fiesta Van, Courier - F Ford Fiesta, XR-2 - F |
| | | 333820 | Ford Escort Mk. V, VI, XR-3, RS - F Ford Escort Turnier / Clipper Mk. V, VI, VII - F Ford Escort Van, Express - F Ford Orion - F |
| | | 333821 | Ford Escort Mk. V, VI, XR-3, RS - F Ford Escort Turnier / Clipper Mk. V, VI, VII - F Ford Escort Van, Express - F Ford Orion - F |
| | | 333822 | Ford Fiesta, XR-2 - F |
| | | 333823 | Ford Fiesta Van, Courier - F Ford Fiesta, XR-2 - F |

NUMERICAL LISTING
 NUMERISCHE LISTE
 LISTE NUMERIQUE

Numerical List

| KYB | VEHICLE FAHRZEUG VEHICULE | KYB | VEHICLE FAHRZEUG VEHICULE |
|------------|--|------------|--|
| 333824 | Renault Clio I - F | 333910 | BMW 3 Series (E36) - F(L) |
| 333825 | Renault Clio I - F | | BMW 3 Series Compact (E36) - F(L) |
| 333826 | Ford Escort Mk. VII, XR-3, RS - F | 333914 | Lancia Y - F |
| | Ford Escort Turnier / Clipper Mk. V, VI, VII - F | 333915 | BMW 3 Series (E36) - F(R) |
| | Ford Escort Van, Express - F | 333916 | BMW 3 Series (E36) - F(L) |
| 333827 | Renault Mégane I Grandtour - F | 333917 | BMW 3 Series (E36) - F(R) |
| | Renault Mégane I, Mégane Classic - F | 333918 | BMW 3 Series (E36) - F(L) |
| | Renault Mégane I, Mégane Coach - F | 333919 | BMW 3 Series (E36) - F(R) |
| | Renault Scénic I - F | | BMW 3 Series Touring (E36) - F(R) |
| | Renault Scénic I (96-03) - F | 333920 | BMW 3 Series (E36) - F(L) |
| 333828 | Citroën C 15 - F | | BMW 3 Series Touring (E36) - F(L) |
| | Citroën Visa - F | 333932▼ | BMW 3 Series (E36) - F(R) |
| | Peugeot 205 - F | | BMW 3 Series Compact (E36) - F(R) |
| 333829 | Peugeot 305 - F | 333933▼ | BMW 3 Series (E36) - F(L) |
| | Peugeot 405 - F | | BMW 3 Series Compact (E36) - F(L) |
| 333830▼ | Peugeot 205 - F | 333942 | Fiat Palio Weekend - F |
| | Peugeot 309 - F | | Fiat Palio, Siena (178) - F |
| 333831 | Opel Combo - F | | Fiat Siena - F |
| | Opel Corsa A, Corsa B - F | | Fiat Strada - F |
| | Opel Tigra - F | 333943 | Ford Puma - F |
| | Vauxhall Combo - F | 333947 | Peugeot 607 - F(R) |
| | Vauxhall Nova, Corsa - F | 333948 | Peugeot 607 - F(L) |
| | Vauxhall Tigra - F | 333951 | Fiat Panda (141) - F |
| 333832 | Ford Sierra - F | | Seat Panda, Marbella - F |
| | Ford Sierra, XR-4, Cosworth - F | | Seat Terra, Trans - F |
| 333833 | Fiat Uno (146) - F | 333962 | Renault Safrane I & II - R |
| 333835 | Skoda Favorit - F | | |
| | Skoda Felicia - F | | 3330000 Series |
| | Skoda Forman - F | 3330039 | Chevrolet - Daewoo Aveo - F(R) |
| | Skoda Pick-Up, Felicia Pick-Up - F | 3330040 | Chevrolet - Daewoo Aveo - F(L) |
| | Volkswagen Golf Caddy - F | 3330041 | Chevrolet - Daewoo Aveo - F(R) |
| 333836▼ | Citroën ZX - F(R) | | Chevrolet - Daewoo Cobalt II - F(R) |
| 333837▼ | Citroën ZX - F(L) | 3330042 | Chevrolet - Daewoo Aveo - F(L) |
| 333838 | Citroën Berlingo - F(R) | | Chevrolet - Daewoo Cobalt II - F(L) |
| | Citroën Xsara (N1/N0) - F(R) | 3330048 | Hyundai Elantra (MD, UD) - F(R) |
| | Citroën Xsara (N2) - F(R) | 3330049 | Hyundai Elantra (MD, UD) - F(L) |
| | Citroën ZX - F(R) | 3330052 | Hyundai Accent III (MC) - F(R) |
| | Peugeot 306 - F(R) | | Kia Rio II (JB) - F(R) |
| | Peugeot Partner, Ranch - F(R) | 3330053 | Hyundai Accent III (MC) - F(L) |
| 333839 | Citroën Berlingo - F(L) | | Kia Rio II (JB) - F(L) |
| | Citroën Xsara (N1/N0) - F(L) | 3330054 | Nissan NV200, NV200 Evalia - F(R) |
| | Citroën Xsara (N2) - F(L) | 3330055 | Nissan NV200, NV200 Evalia - F(L) |
| | Citroën ZX - F(L) | 3330056 | Hyundai Matrix (FC) - R(R) |
| | Peugeot 306 - F(L) | 3330057 | Hyundai Matrix (FC) - R(L) |
| | Peugeot Partner, Ranch - F(L) | 3330073▼ | Hyundai Veloster (FS) - F(R) |
| 333840 | Seat Ibiza, Cordoba - F | 3330074▼ | Hyundai Veloster (FS) - F(L) |
| | Seat Malaga - F | 3330079 | Chevrolet - Daewoo Matiz / Spark (M300) - F(R) |
| 333841 | Ford Escort Mk. VII, XR-3, RS - F | 3330080 | Chevrolet - Daewoo Matiz / Spark (M300) - F(L) |
| | Ford Escort Turnier / Clipper Mk. V, VI, VII - F | 3330083 | Mazda Mazda 2, Demio (DL, DJ) - F(R) |
| 333843 | Fiat Punto (176) - F | 3330084 | Mazda Mazda 2, Demio (DL, DJ) - F(L) |
| 333847 | Renault R 5 (Super 5) Express, Rapide, Extra - F | 3330093 | Hyundai Veloster (FS) - F(R) |
| 333848 | Nissan Kubistar - F | 3330094 | Hyundai Veloster (FS) - F(L) |
| | Renault Kangoo - F | 3330119 | Kia Soul I (AM) - F(R) |
| 333849 | Renault Clio I - F | 3330120 | Kia Soul I (AM) - F(L) |
| 333870 | Fiat Seicento (187) - F | 3330121 | Hyundai ix20 (JC) - F(R) |
| 333909 | BMW 3 Series (E36) - F(R) | | Kia Venga (YN) - F(R) |
| | BMW 3 Series Compact (E36) - F(R) | 3330122 | Hyundai ix20 (JC) - F(L) |

| NUMERICAL LISTING NUMERISCHE LISTE LISTE NUMERIQUE | | | |
|--|--|----------------------|--|
| KYB | VEHICLE FAHRZEUG VEHICULE | KYB | VEHICLE FAHRZEUG VEHICULE |
| 3330127 3330128 | Kia Venga (YN) - F(L) Suzuki Swift V (AZ) - F(R) Suzuki Swift V (AZ) - F(L) | 3338052 | Citroën C3 Aircross II (2R_, 2C_) - F(L) Opel Crossland X / Crossland (P17, P2QO) - F(L) Vauxhall Crossland X (P17) - F(L) |
| 3338000 Series | | 3338053 | Peugeot 208 I (CA_, CC_) - F(R) |
| 3338000 | Citroën C-Elysée - F(R) Peugeot 301 - F(R) | 3338054 | Peugeot 208 I (CA_, CC_) - F(L) |
| 3338001 | Citroën C-Elysée - F(L) Peugeot 301 - F(L) | 3338055 | Peugeot 2008 I (CU_) - F(R) |
| 3338002 | Peugeot 2008 - F(R) | 3338056 | Peugeot 2008 I (CU_) - F(L) |
| 3338003 | Peugeot 2008 - F(L) | 3338057 | Citroën C3 III (SX_, SY_) - F(R) Citroën C4 Cactus - F(R) |
| 3338004 | Peugeot 2008 - F(R) | 3338058 | Citroën C3 III (SX_, SY_) - F(L) Citroën C4 Cactus - F(L) |
| 3338005 | Peugeot 2008 - F(L) | 334000 Series | |
| 3338008 | Renault Captur - F | 334013 | Toyota Celica - R(R) |
| 3338009 | Renault Zoe - F | 334014 | Toyota Celica - R(L) |
| 3338010 | Renault Wind - F | 334017 | Mercedes Benz 190 Series (W201) - F Mercedes Benz E Series, E-Class (124) - F |
| 3338011 | Mercedes-Benz Citan - F Renault Kangoo - F | 334018 | Ford Scorpio/ Granada (GAE/GGE) - F |
| 3338012 | Peugeot 208 - F(R) | 334019 | Mitsubishi Colt - F Mitsubishi Lancer - F |
| 3338013 | Peugeot 208 - F(L) | 334020▼ | Hyundai Sonata / Sonica - F |
| 3338014 | Peugeot 208 - F(R) | 334022 | Citroën Visa - F(R) Peugeot 205 - F(R) Peugeot 309 - F(R) |
| 3338015 | Peugeot 208 - F(L) | 334023 | Citroën Visa - F(L) Peugeot 205 - F(L) Peugeot 309 - F(L) |
| 3338016 | Mitsubishi Colt - F(R) | 334027 | Toyota Carina II - R(R) |
| 3338017 | Mitsubishi Colt - F(L) | 334028 | Toyota Carina II - R(L) |
| 3338018 | Mitsubishi Colt - F(R) | 334029 | Saab 9000 - F |
| 3338019 | Mitsubishi Colt - F(L) | 334030 | Mitsubishi Eclipse - F Mitsubishi Galant, Sapporo (Lambda), Sigma - F |
| 3338020 | Mitsubishi Colt - F(R) | 334033▼ | Mitsubishi Cordia & Tredia - F Mitsubishi Space Wagon, Space Van (Chariot), Expo - F |
| 3338021 | Mitsubishi Colt - F(L) | 334044▼ | Mitsubishi Galant, Sapporo (Lambda), Sigma - F |
| 3338022 | Renault Twingo - F Smart Forfour - F Smart Fortwo Coupé, Fortwo Cabrio - F | 334045 | Nissan 100 NX - R(R) Nissan Sunny - R(R) |
| 3338023 | Dacia Lodgy - F Renault Lodgy - F | 334046 | Nissan 100 NX - R(L) Nissan Sunny - R(L) |
| 3338034 | Dacia Dokker, Dokker Express - F Dacia Lodgy - F Renault Dokker, Dokker Express - F Renault Lodgy - F | 334047 | Nissan 100 NX - R(R) Nissan Sunny - R(R) |
| 3338036 | Renault Clio IV Grandtour (KH_) - F | 334048 | Nissan 100 NX - R(L) Nissan Sunny - R(L) |
| 3338037 | Renault Clio IV (BH_) - F Renault Clio IV Grandtour (KH_) - F | 334049▼ | Mitsubishi Lancer - F |
| 3338038 | Seat Mii (KF1) - F Skoda Citigo - F Volkswagen Up, Load Up (12_, BL_) - F | 334050 | Toyota Celica - R(R) |
| 3338041 | Volkswagen Up, Load Up (12_, BL_) - F | 334051 | Toyota Celica - R(L) |
| 3338042 | Dacia Sandero Stepway II - F Lada X Ray (GAB_) - F Renault Sandero II (B8_) - F Renault Sandero Stepway II (B8_) - F | 334052 | Toyota Celica - R(R) |
| 3338043 | Smart Forfour I (454) - F(R) | 334053 | Toyota Celica - R(L) |
| 3338044 | Smart Forfour I (454) - F(L) | 334054▼ | Toyota Camry - R(R) |
| 3338047 | Nissan Micra V (K14) - F(R) | 334055▼ | Toyota Camry - R(L) |
| 3338048 | Nissan Micra V (K14) - F(L) | 334056 | Nissan Primera - R(R) |
| 3338049 | Citroën C3 Aircross II (2R_, 2C_) - F(R) | 334057 | Nissan Primera - R(L) |
| 3338050 | Citroën C3 Aircross II (2R_, 2C_) - F(L) | 334061 | Toyota Carina - R(R) |
| 3338051 | Citroën C3 Aircross II (2R_, 2C_) - F(R) Opel Crossland X / Crossland (P17, P2QO) - F(R) Vauxhall Crossland X (P17) - F(R) | 334062 | Toyota Carina - R(L) |
| | | 334063 | Toyota Carina - R(R) |
| | | 334064 | Toyota Carina - R(L) |

NUMERICAL LISTING
 NUMERISCHE LISTE
 LISTE NUMERIQUE

Numerical List

| KYB | VEHICLE FAHRZEUG VEHICULE | KYB | VEHICLE FAHRZEUG VEHICULE |
|------------|--|------------|--|
| 334068 | Honda Concerto - F(R) Rover 200 Series - F(R) Rover 400 Series - F(R) | 334108 | Subaru Legacy - R(L) |
| 334069 | Honda Concerto - F(L) Rover 200 Series - F(L) Rover 400 Series - F(L) | 334109 | Subaru Impreza (GC, GF) - R(R) Subaru Legacy - R(R) |
| 334070 | Hyundai Santamo - F Kia Joice - F Mitsubishi Santamo - F Mitsubishi Space Runner - F Mitsubishi Space Wagon, Space Van (Chariot), Expo - F | 334110 | Subaru Impreza (GC, GF) - R(L) Subaru Legacy - R(L) |
| 334071 | Hyundai Santamo - F Mitsubishi Santamo - F Mitsubishi Space Runner - F Mitsubishi Space Wagon, Space Van (Chariot), Expo - F | 334111 | Subaru Legacy - F(R) |
| 334072 | Mitsubishi Colt - F(R) Mitsubishi Lancer - F(R) Proton Persona, 400 Series, Wira - F(R) | 334112 | Subaru Legacy - F(L) |
| 334073 | Mitsubishi Colt - F(L) Mitsubishi Lancer - F(L) Proton Persona, 400 Series, Wira - F(L) | 334115 | Subaru Legacy - R(R) |
| 334082 | Mazda 626, Montrose - F(R) Mazda MX-6 - F(R) | 334116 | Subaru Legacy - R(L) |
| 334083 | Mazda 626, Montrose - F(L) Mazda MX-6 - F(L) | 334117 | Mazda 323 F - F(R) |
| 334084 | Mazda 626, Montrose - R Mazda MX-6 - R | 334118 | Mazda 323 F - F(L) |
| 334085▼ | Mazda 626, Montrose - R Mazda MX-6 - R | 334119 | Mazda 323 F - R(R) |
| 334088▼ | Hyundai Lantra - F | 334120 | Mazda 323 F - R(L) |
| 334089▼ | Mazda 626, Montrose - F(R) | 334123▼ | Mazda 323 F - R(R) |
| 334090▼ | Mazda 626, Montrose - F(L) | 334124▼ | Mazda 323 F - R(L) |
| 334093 | Toyota Previa / Emina / Lucida - F(R) | 334125 | Toyota Celica - R(R) |
| 334094 | Toyota Previa / Emina / Lucida - F(L) | 334126 | Toyota Celica - R(L) |
| 334097▼ | Proton Coupé - F(R) Proton Persona Compact, 300 Series - F(R) Proton Persona, 400 Series, Wira - F(R) | 334127 | Toyota Celica - R(R) |
| 334098▼ | Proton Coupé - F(L) Proton Persona Compact, 300 Series - F(L) Proton Persona, 400 Series, Wira - F(L) | 334128 | Toyota Celica - R(L) |
| 334099▼ | Opel Omega A Caravan, Omega B Caravan - F(R) Opel Omega A, Omega B - F(R) Opel Senator, Monza - F(R) Vauxhall Carlton, Viceroy, Omega - F(R) Vauxhall Royale, Senator - F(R) | 334129▼ | Mazda Savanna RX 7 - F(R) |
| 334100▼ | Opel Omega A Caravan, Omega B Caravan - F(L) Opel Omega A, Omega B - F(L) Opel Senator, Monza - F(L) Vauxhall Carlton, Viceroy, Omega - F(L) Vauxhall Royale, Senator - F(L) | 334130▼ | Mazda Savanna RX 7 - F(L) |
| 334103▼ | Rover 200 Series - F(R) Rover 400 Series - F(R) | 334137 | Toyota Carina - F(R) |
| 334104▼ | Rover 200 Series - F(L) Rover 400 Series - F(L) | 334138 | Toyota Carina - F(L) |
| 334105 | Subaru Legacy - F(R) | 334139 | Suzuki Santana SE416 Vitara - F(R) Suzuki Vitara - F(R) Suzuki X-90 - F(R) |
| 334106 | Subaru Legacy - F(L) | 334140 | Suzuki Santana SE416 Vitara - F(L) Suzuki Vitara - F(L) Suzuki X-90 - F(L) |
| 334107 | Subaru Legacy - R(R) | 334141 | Hyundai Sonata / Sonica - F |
| | | 334142 | Nissan Serena - F(R) Nissan Serena Cargo, Vanette Cargo - F(R) |
| | | 334143 | Nissan Serena - F(L) Nissan Serena Cargo, Vanette Cargo - F(L) |
| | | 334144 | Subaru Legacy - R(R) |
| | | 334145 | Subaru Legacy - R(L) |
| | | 334146 | Subaru Impreza (GC, GF) - R(R) Subaru Legacy - R(R) |
| | | 334147 | Subaru Impreza (GC, GF) - R(L) Subaru Legacy - R(L) |
| | | 334154 | Mitsubishi Carisma - F(R) Volvo S 40, V 40 - F(R) |
| | | 334155 | Mitsubishi Carisma - F(L) Volvo S 40, V 40 - F(L) |
| | | 334156 | Rover 200 Series - F Rover 25 - F Rover 400 Series - F |
| | | 334157▼ | Mazda 626, Montrose - R |
| | | 334158 | Nissan Maxima, QX - F(R) |
| | | 334159 | Nissan Maxima, QX - F(L) |
| | | 334160 | Nissan Prairie - F(R) |
| | | 334161 | Nissan Prairie - F(L) |
| | | 334164 | Subaru Legacy - R(R) |
| | | 334165 | Subaru Legacy - R(L) |
| | | 334166 | Subaru Legacy - F(R) |
| | | 334167 | Subaru Legacy - F(L) |
| | | 334170 | Toyota Camry - F(R) |



NUMERICAL LISTING
 NUMERISCHE LISTE
 LISTE NUMERIQUE

| KYB | VEHICLE FAHRZEUG VEHICULE | KYB | VEHICLE FAHRZEUG VEHICULE |
|------------|--|------------|--|
| 334171 | Toyota Camry - F(L) | 334248 | Mitsubishi Space Star - F(L) |
| 334172 | Toyota Picnic - F(R) | 334251 | Toyota RAV 4 - F(R) |
| 334173 | Toyota Picnic - F(L) | 334252 | Toyota RAV 4 - F(L) |
| 334174 | Volvo S 40, V 40 - F(R) | 334253 | Subaru Impreza (GC, GF) - F(R) |
| 334175 | Volvo S 40, V 40 - F(L) | | Subaru Legacy - F(R) |
| 334176 | Toyota Corolla - F(R) | 334254 | Subaru Impreza (GC, GF) - F(L) |
| 334177 | Toyota Corolla - F(L) | | Subaru Legacy - F(L) |
| 334178 | Toyota Corolla - R(R) | 334255 | Subaru Impreza (GC, GF) - F(R) |
| 334179 | Toyota Corolla - R(L) | 334256 | Subaru Impreza (GC, GF) - F(L) |
| 334184 | Nissan Silvia, 200 SX - F(R) | 334259 | Mazda Premacy - R(R) |
| 334185 | Nissan Silvia, 200 SX - F(L) | 334260 | Mazda Premacy - R(L) |
| 334186 | Toyota Corolla - F(R) | 334261 | Lexus RX - F(R) |
| 334187 | Toyota Corolla - F(L) | 334262 | Lexus RX - F(L) |
| 334188 | Chrysler Voyager / Mini-Van, Town & Country, Caravan - F | 334263 | Lexus RX - R(R) |
| 334189 | Subaru Forester - F(R) | 334264 | Lexus RX - R(L) |
| 334190 | Subaru Forester - F(L) | 334265 | Nissan Maxima, QX - F(R) |
| 334191 | Subaru Forester - R(R) | 334266 | Nissan Maxima, QX - F(L) |
| 334192 | Subaru Forester - R(L) | 334269 | Lexus RX - R(R) |
| 334195 | Suzuki Grand Vitara I - F(R) | 334270 | Lexus RX - R(L) |
| 334196 | Suzuki Grand Vitara I - F(L) | 334273 | Subaru Legacy - F(R) |
| 334197 | Mazda 626 - F(R) | 334274 | Subaru Legacy - F(L) |
| | Mazda 626, Montrose - F(R) | 334275 | Subaru Legacy - F(R) |
| 334198 | Mazda 626 - F(L) | 334276 | Subaru Legacy - F(L) |
| | Mazda 626, Montrose - F(L) | 334277 | Toyota Celica - F(R) |
| 334199 | Mazda 626 - F(R) | 334278 | Toyota Celica - F(L) |
| | Mazda 626, Montrose - F(R) | 334279 | Mazda Xedos 6 - F(R) |
| 334200 | Mazda 626 - F(L) | 334280 | Mazda Xedos 6 - F(L) |
| | Mazda 626, Montrose - F(L) | 334281 | Mazda Xedos 6 - R |
| 334201 | Mazda 626, Montrose - R(R) | 334282 | Mazda MPV - F(R) |
| 334202 | Mazda 626, Montrose - R(L) | 334283 | Mazda MPV - F(L) |
| 334203 | Toyota Avensis - F(R) | 334284 | Toyota Previa / Emina / Lucida - F(R) |
| 334204 | Toyota Avensis - F(L) | 334285 | Toyota Previa / Emina / Lucida - F(L) |
| 334207▼ | Chevrolet - Daewoo Nubira - F(R) | 334300 | Subaru Impreza (GD, GG) - F(R) |
| 334208▼ | Chevrolet - Daewoo Nubira - F(L) | 334301 | Subaru Impreza (GD, GG) - F(L) |
| 334209 | Chevrolet - Daewoo Nubira - F(R) | 334302 | Subaru Impreza (GD, GG) - R(R) |
| | Chevrolet - Daewoo Nubira II - F(R) | 334303 | Subaru Impreza (GD, GG) - R(L) |
| 334210 | Chevrolet - Daewoo Nubira - F(L) | 334304 | Subaru Impreza (GD, GG) - F(R) |
| | Chevrolet - Daewoo Nubira II - F(L) | 334305 | Subaru Impreza (GD, GG) - F(L) |
| 334213▼ | Chevrolet - Daewoo Leganza - R(R) | 334306 | Subaru Impreza (GD, GG) - R(R) |
| 334214▼ | Chevrolet - Daewoo Leganza - R(L) | 334307 | Subaru Impreza (GD, GG) - R(L) |
| 334217 | Ford-Mercury Probe - R | 334308 | Mitsubishi Carisma - F(R) |
| 334219 | Ford Sierra - F | | Mitsubishi Space Star - F(R) |
| 334227 | Opel Sintra - F | 334309 | Mitsubishi Carisma - F(L) |
| | Vauxhall Sintra - F | | Mitsubishi Space Star - F(L) |
| 334231 | Kia Clarus - F(R) | 334310 | Toyota MR 2 III - R(R) |
| 334232 | Kia Clarus - F(L) | 334311 | Toyota MR 2 III - R(L) |
| 334233▼ | Kia Clarus - R(R) | 334319 | Toyota Avensis Verso - F(R) |
| 334234▼ | Kia Clarus - R(L) | 334320 | Toyota Avensis Verso - F(L) |
| 334235 | Mitsubishi Space Wagon, Space Van (Chariot), Expo - F(R) | 334327 | Mitsubishi Space Runner - F(R) |
| 334236 | Mitsubishi Space Wagon, Space Van (Chariot), Expo - F(L) | 334328 | Mitsubishi Space Runner - F(L) |
| 334237 | Hyundai Highway Van - F(R) | 334329 | Toyota Avensis - R(R) |
| | Hyundai Trajet - F(R) | 334330 | Toyota Avensis - R(L) |
| 334238 | Hyundai Highway Van - F(L) | 334333 | Ford Maverick - F(R) |
| | Hyundai Trajet - F(L) | | Mazda Tribute - F(R) |
| 334243 | Honda HR-V - F(R) | 334334 | Ford Maverick - F(L) |
| 334244 | Honda HR-V - F(L) | | Mazda Tribute - F(L) |
| 334247 | Mitsubishi Space Star - F(R) | 334335 | Chrysler Voyager / Mini-Van, Town & Country, Caravan - F |



Numerical List

NUMERICAL LISTING
 NUMERISCHE LISTE
 LISTE NUMERIQUE

Numerical List

| KYB | VEHICLE FAHRZEUG VEHICULE | KYB | VEHICLE FAHRZEUG VEHICULE |
|------------|--|------------|--|
| 334338 | Toyota Camry - F(R) | 334460 | Subaru Impreza (GD, GG) - F(R) |
| 334339 | Toyota Camry - F(L) | 334461 | Subaru Impreza (GD, GG) - F(L) |
| 334340 | Toyota Camry - R(R) | 334462 | Subaru Impreza (GD, GG) - F(R) |
| 334341 | Toyota Camry - R(L) | 334463 | Subaru Impreza (GD, GG) - F(L) |
| 334342 | Subaru Forester - F(R) | 334464 | Suzuki Grand Vitara II - F(R) |
| 334343 | Subaru Forester - F(L) | 334465 | Suzuki Grand Vitara II - F(L) |
| 334344 | Subaru Forester - R(R) | 334468 | Subaru Forester - F(R) |
| 334345 | Subaru Forester - R(L) | 334469 | Subaru Forester - F(L) |
| 334354 | Volvo S 40, V 40 - F(R) | 334476 | Toyota Camry - F(R) |
| 334355 | Volvo S 40, V 40 - F(L) | 334477 | Toyota Camry - F(L) |
| 334356 | Subaru Impreza (GD, GG) - R(R) | 334478 | Toyota Camry - R(R) |
| 334357 | Subaru Impreza (GD, GG) - R(L) | 334479 | Toyota Camry - R(L) |
| 334358 | Subaru Impreza (GD, GG) - R(R) | 334480 | Nissan Maxima, QX - F(R) |
| 334359 | Subaru Impreza (GD, GG) - R(L) | 334481 | Nissan Maxima, QX - F(L) |
| 334360 | Nissan X-Trail - F(R) | 334482 | Toyota RAV 4 - F(R) |
| 334361 | Nissan X-Trail - F(L) | 334483 | Toyota RAV 4 - F(L) |
| 334362 | Nissan X-Trail - R(R) | 334504▼ | Hyundai Tucson - R(R) |
| 334363 | Nissan X-Trail - R(L) | | Kia Sportage - R(R) |
| 334366 | Nissan Maxima, QX - F(R) | 334505▼ | Hyundai Tucson - R(L) |
| 334367 | Nissan Maxima, QX - F(L) | | Kia Sportage - R(L) |
| 334369 | Mitsubishi Lancer - F | 334508▼ | Kia Carens - F(R) |
| | Mitsubishi Lancer Estate - F | | Kia Magentis - F(R) |
| 334370 | Subaru Forester - F(R) | 334509▼ | Kia Carens - F(L) |
| 334371 | Subaru Forester - F(L) | | Kia Magentis - F(L) |
| 334372 | Subaru Legacy - F(R) | 334604 | BMW Z3 - F(R) |
| 334373 | Subaru Legacy - F(L) | 334605 | BMW Z3 - F(L) |
| 334374 | Subaru Legacy - F(R) | 334609 | Opel Vectra B - F(R) |
| 334375 | Subaru Legacy - F(L) | | Vauxhall Vectra B - F(R) |
| 334378 | Toyota Celica - F(R) | 334610 | Opel Vectra B - F(L) |
| 334379 | Toyota Celica - F(L) | | Vauxhall Vectra B - F(L) |
| 334380 | Nissan Murano - F(R) | 334611 | Volvo S 60 - F |
| 334381 | Nissan Murano - F(L) | | Volvo S 70, V 70, C 70 - F |
| 334384 | Lexus RX - R(R) | | Volvo S 80 - F |
| 334385 | Lexus RX - R(L) | 334612 | Lancia Lybra - F |
| 334386 | Toyota Camry - F(R) | 334614 | BMW 3 Series (E46) - F(R) |
| 334387 | Toyota Camry - F(L) | | BMW 3 Series Compact (E46) - F(R) |
| 334388 | Toyota Camry - R(R) | | BMW 3 Series Touring (E46) - F(R) |
| 334389 | Toyota Camry - R(L) | 334615 | BMW 3 Series (E46) - F(L) |
| 334390 | Mitsubishi FTO - F(R) | | BMW 3 Series Compact (E46) - F(L) |
| 334391 | Mitsubishi FTO - F(L) | | BMW 3 Series Touring (E46) - F(L) |
| 334392 | Mitsubishi Space Wagon, Space Van (Chariot), Expo - F(R) | 334620 | Mercedes Benz V-Class (638/2) - F |
| 334393 | Mitsubishi Space Wagon, Space Van (Chariot), Expo - F(L) | | Mercedes Benz Vito - F |
| 334394 | Lexus RX - R(R) | 334621 | Mini Mini - F(R) |
| 334395 | Lexus RX - R(L) | 334622 | Mini Mini - F(L) |
| 334398 | Mitsubishi Outlander - F | 334623 | Land Rover Freelander / Freelander Soft top - R(R) |
| 334399 | Lexus RX - F(R) | 334624 | Land Rover Freelander / Freelander Soft top - R(L) |
| 334400 | Lexus RX - F(L) | 334625 | BMW 1 Series (E81,E87) - F(R) |
| 334418 | Mazda MPV - F(R) | | BMW 1 Series (E82) - F(R) |
| 334419 | Mazda MPV - F(L) | | BMW 1 Series (E88) - F(R) |
| 334420 | Mitsubishi Lancer - F | | BMW 1 Series (E81,E87) - F(L) |
| | Mitsubishi Lancer Estate - F | 334626 | BMW 1 Series (E82) - F(L) |
| 334438 | Volvo S 40, V 40 - F(R) | | BMW 1 Series (E88) - F(L) |
| 334439 | Volvo S 40, V 40 - F(L) | 334629 | Ford Tourneo connect / Transit connect - F(R) |
| 334456 | Mitsubishi Grandis - F(R) | 334630 | Ford Tourneo connect / Transit connect - F(L) |
| 334457 | Mitsubishi Grandis - F(L) | 334631 | Fiat Doblo, Doblo Cargo - F |
| 334458 | Mitsubishi Grandis - F(R) | 334632▼ | Fiat Croma II (194) - F(R) |
| 334459 | Mitsubishi Grandis - F(L) | | Opel Signum - F(R) |

NUMERICAL LISTING
 NUMERISCHE LISTE
 LISTE NUMERIQUE

|  | VEHICLE FAHRZEUG VEHICULE |  | VEHICLE FAHRZEUG VEHICULE |
|---|--|---|--|
| 334633 ▼ | Opel Vectra C - F(R) Vauxhall Signum - F(R) Vauxhall Vectra C - F(R) Fiat Croma II (194) - F(L) Opel Signum - F(L) Opel Vectra C - F(L) Vauxhall Signum - F(L) Vauxhall Vectra C - F(L) | | Volkswagen Golf Cabrio - F Volkswagen Golf II, Jetta II - F Volkswagen Golf III Variant - F Volkswagen Golf III, Vento , Jetta III - F Volkswagen Passat - F Volkswagen Polo, Derby - F Volkswagen Polo, Polo Variant - F |
| 334634 | Opel Signum - F(R) Opel Vectra C - F(R) Vauxhall Signum - F(R) Vauxhall Vectra C - F(R) | 334811 334812 | Volkswagen Passat - F Audi A3 (8L1) - F Seat Leon I - F Seat Toledo II - F Skoda Octavia I - F |
| 334635 | Opel Signum - F(L) Opel Vectra C - F(L) Vauxhall Signum - F(L) Vauxhall Vectra C - F(L) | | Skoda Octavia I Combi - F Volkswagen Bora Variant - F Volkswagen Bora, Jetta IV - F Volkswagen Golf IV - F Volkswagen Golf IV Variant - F Volkswagen New Beetle - F |
| 334642 | Chrysler Caliber - F(R) | | Mitsubishi Pajero Pinin - F |
| 334643 | Chrysler Caliber - F(L) | | Renault Espace - F |
| 334660 | Renault Scénic I (96-03) - F | 334813 | Renault VelSatis - F |
| 334661 | Renault R 25 - R | 334814 | Toyota Avenis - F(R) |
| 334667 | Fiat Coupé (175) - F | | Toyota Avenis - F(L) |
| 334668 | Saab 9-3 (YS3F) - F(L) | 334815 | Toyota Corolla - F(R) |
| 334669 | Saab 9-3 (YS3F) - F(R) | 334816 | Toyota Corolla - F(L) |
| 334670 | Audi A3 (8L1) - F Seat Leon I - F Skoda Octavia I Combi - F Volkswagen Bora Variant - F Volkswagen Bora, Jetta IV - F Volkswagen Golf IV - F Volkswagen Golf IV Variant - F | 334817 334818 334821 334822 334823 334824 334825 334826 | Peugeot 1007 - F(L) Citroën C2 - F(R) Citroën C3 I - F(R) Citroën C3 Pluriel - F(R) Peugeot 1007 - F(R) Citroën C3 I - F(L) Citroën C3 I - F(R) Renault Mégane I, Mégane Classic - F Renault Mégane I, Mégane Coach - F Renault Scénic II, Grand Scénic II - F Toyota Corolla Verso - F(R) Toyota Corolla Verso - F(L) Audi A3 (8P1), A3 (8P7) - F Audi A3 Sportback (8PA) - F Seat Altea, Altea XL - F Seat Leon II - F Seat Toledo III - F Skoda Octavia II - F Skoda Octavia II Combi - F Skoda Yeti - F Volkswagen Beetle - F Volkswagen Caddy Life, Caddy Maxi Life - F Volkswagen Caddy, Caddy Maxi - F Volkswagen Golf V - F |
| 334690 | Jaguar X-Type - F | | |
| 334691 | Fiat Idea (135) - F Lancia Musa - F Lancia Ypsilon - F | | |
| 334696 ▼ | Fiat Bravo, Brava (182) - F | 334827 | |
| 334697 | Fiat Barchetta (183) - F | | |
| 334698 | Mini Mini - F(R) | | |
| 334699 | Mini Mini - F(L) | | |
| 334700 | Mazda Mazda 3 - F(R) Mazda Mazda 5 - F(R) | 334828 334829 | |
| 334701 | Mazda Mazda 3 - F(L) Mazda Mazda 5 - F(L) | 334830 | |
| 334801 | Alfa Romeo Alfa 164 - R Fiat Croma (154) - R Lancia Thema - R | 334831 334832 334833 | |
| 334802 | Renault Laguna I - F | 334834 | |
| 334804 | Fiat Croma (154) - F Lancia Thema - F | | |
| 334805 | Fiat Punto (176) - F Lancia Y - F | | |
| 334807 ▼ | Renault Laguna I - F | | |
| 334808 | Renault Mégane I, Mégane Classic - F Renault Mégane I, Mégane Coach - F | | |
| 334810 | Seat Cordoba Vario - F Seat Ibiza, Cordoba - F Seat Toledo I - F Volkswagen Corrado - F | | |

NUMERICAL LISTING
 NUMERISCHE LISTE
 LISTE NUMERIQUE

Numerical List

| KYB | VEHICLE FAHRZEUG VEHICULE | KYB | VEHICLE FAHRZEUG VEHICULE |
|------------|--|---|--|
| 334834 | Volkswagen Golf V Plus - F Volkswagen Golf V Variant - F Volkswagen Golf VI - F Volkswagen Golf VI Variant - F Volkswagen Jetta V - F Volkswagen Jetta VI - F | 334902 334903 | BMW 3 Series (E36) - F(L) Opel Omega A Caravan, Omega B Caravan - F Opel Omega A, Omega B - F Vauxhall Carlton, Viceroy, Omega - F |
| 334835 | Audi A2 (8Z0) - F Seat Ibiza, Cordoba - F Skoda Fabia - F Skoda Roomster, Praktik - F Volkswagen Fox (5Z1) - F Volkswagen Polo - F | 334923 334924 334925 334926 334927 | BMW 3 Series (E36) - F(R) BMW 3 Series (E36) - F(L) BMW 3 Series (E36) - F(R) BMW 3 Series (E36) - F(L) Citroën Evasion / Synergie - F Fiat Ulysse - F Lancia Zeta - F Peugeot 806 - F |
| 334837 | Renault Scénic I - F | 334928 | Citroën Jumpy / Dispatch - F Fiat Scudo (220) - F Peugeot Expert - F |
| 334838 | Ford C-Max - F(R) Ford Focus C-Max - F(R) Ford Focus II - F(R) Ford Focus II Cabrio - F(R) Ford Focus II Turnier - F(R) | 334930 334937 334938 | Alfa Romeo Alfa 145/146 - F BMW 3 Series (E36) - F(R) BMW 3 Series (E36) - F(L) |
| 334839 | Ford C-Max - F(L) Ford Focus C-Max - F(L) Ford Focus II - F(L) Ford Focus II Cabrio - F(L) Ford Focus II Turnier - F(L) | 334945 334946 | BMW 3 Series (E46) - F(R) BMW 3 Series Touring (E46) - F(R) BMW 3 Series (E46) - F(L) BMW 3 Series Touring (E46) - F(L) |
| 334840 | Ford C-Max - F(R) Ford Focus C-Max - F(R) Ford Focus II - F(R) Ford Focus II Turnier - F(R) | 334947 | Ford Galaxy - F Seat Alhambra - F Volkswagen Sharan - F Renault Safrane I & II - F |
| 334841 | Ford C-Max - F(L) Ford Focus C-Max - F(L) Ford Focus II - F(L) Ford Focus II Turnier - F(L) | 334961 334962 334963 334967▼ | Rover 75, RJ - F(R) Rover 75, RJ - F(L) Citroën Nemo , Nemo Combi - F(R) Fiat Fiorino, Fiorino Qubo - F(R) Peugeot Bipper, Bipper Tepee - F(R) |
| 334842 | Volvo C 30 - F(R) Volvo S 40, V 50 - F(R) | 334968▼ | Citroën Nemo , Nemo Combi - F(L) Fiat Fiorino, Fiorino Qubo - F(L) Peugeot Bipper, Bipper Tepee - F(L) |
| 334843 | Volvo C 30 - F(L) Volvo S 40, V 50 - F(L) | 334970▼ | Volvo S 80 II - F(R) Volvo V 70 III - F(R) Volvo XC 70 II - F(R) |
| 334844 | Opel Zafira I - F(R) Vauxhall Zafira I - F(R) | 334971▼ | Volvo S 80 II - F(L) Volvo V 70 III - F(L) Volvo XC 70 II - F(L) |
| 334845 | Opel Zafira I - F(L) Vauxhall Zafira I - F(L) | 334972▼ 334973▼ | Volvo XC 60 - F(R) Volvo XC 60 - F(L) |
| 334846 | Opel Astra - F(R) Vauxhall Astra - F(R) | 3340000 Series | |
| 334847 | Opel Astra - F(L) Vauxhall Astra - F(L) | 3340033 3340034 3340035 3340036 3340045 3340046 3340083 | Nissan X-Trail (T31) - F(R) Nissan X-Trail (T31) - F(L) Mazda Mazda 3 (BM, BN) - F(R) Mazda Mazda 3 (BM, BN) - F(L) Mitsubishi Outlander III (GF_W, GG_W) - F(R) Mitsubishi Outlander III (GF_W, GG_W) - F(L) Kia Carens - F(R) Kia Magentis - F(R) |
| 334848 | Fiat Tempra (159) - F Fiat Tempra Station Wagon / Familia (159) - F Fiat Tipo (160) - F Lancia Dedra (835) - F Lancia Delta - F | 3340084 | Kia Carens - F(L) Kia Magentis - F(L) |
| 334849 | Fiat Bravo, Brava (182) - F | 3340113 3340114 3340115 | Toyota RAV 4 - F(R) Toyota RAV 4 - F(L) Kia Magentis - F(R) |
| 334861 | Fiat Marea (185) - F Lancia Dedra (835) - F | | |
| 334862 | Fiat Marea (185) - F | | |
| 334863 | Fiat Multipla (186) - F | | |
| 334864 | Fiat Punto (188) - F | | |
| 334865 | Fiat Punto (188) - F | | |
| 334866 | Fiat Punto (188) - F | | |
| 334901 | BMW 3 Series (E36) - F(R) | | |

NUMERICAL LISTING
 NUMERISCHE LISTE
 LISTE NUMERIQUE

| KYB | VEHICLE FAHRZEUG VEHICULE | KYB | VEHICLE FAHRZEUG VEHICULE |
|----------------|--|------------|--|
| 3340116 | Kia Magentis - F(L) | | Fiat Grande Punto (199) - F(R) |
| 3340121 | Kia Sorento - F(R) | | Fiat Punto (199) - F(R) |
| 3340122 | Kia Sorento - F(L) | | Fiat Punto Evo (199) - F(R) |
| 3340136 | Hyundai i40 (VF) - F(R) | 3348004 | Fiat 500 L - F(L) |
| | Hyundai i40 CW (VF) - F(R) | | Fiat Grande Punto (199) - F(L) |
| 3340137 | Hyundai i40 (VF) - F(L) | | Fiat Punto (199) - F(L) |
| | Hyundai i40 CW (VF) - F(L) | | Fiat Punto Evo (199) - F(L) |
| 3340138 | Mazda CX-3 (DK) - F(R) | 3348005 | Chrysler Ypsilon - F(R) |
| 3340139 | Mazda CX-3 (DK) - F(L) | | Lancia Ypsilon - F(R) |
| 3340158 | Nissan X-Trail (T32_) - F(R) | 3348006 | Chrysler Ypsilon - F(L) |
| 3340159 | Nissan X-Trail (T32_) - F(L) | | Lancia Ypsilon - F(L) |
| 3340160 | Opel Zafira Tourer C (P12) - F(R) | 3348007 | Renault Fluence - F |
| | Vauxhall Zafira Tourer Mk III (P12) - F(R) | 3348008 | Renault Latitude - F(R) |
| 3340161 | Opel Zafira Tourer C (P12) - F(L) | 3348009 | Renault Latitude - F(L) |
| | Vauxhall Zafira Tourer Mk III (P12) - F(L) | 3348010 | Renault Kangoo II, Grand Kangoo II, Kangoo II Be Bop - F |
| 3340162 | Hyundai i30 Coupé - F(R) | 3348011 | Renault Mégane CC - F |
| | Hyundai i30 CW II (GD) - F(R) | 3348012 | DS DS 3 (SA_, SB_) - F(R) |
| | Hyundai i30 II (GD) - F(R) | | Peugeot 208 - F(R) |
| | Kia Cee'd (JD) - F(R) | 3348013 | DS DS 3 (SA_, SB_) - F(L) |
| | Kia Cee'd Sportswagon (JD) - F(R) | | Peugeot 208 - F(L) |
| | Kia ProCee'd (JD) - F(R) | 3348014 | Ford C-Max II - F(R) |
| 3340163 | Hyundai i30 Coupé - F(L) | | Ford Focus III - F(R) |
| | Hyundai i30 CW II (GD) - F(L) | | Ford Focus III Turnier - F(R) |
| | Hyundai i30 II (GD) - F(L) | | Ford Grand C-Max, Grand C-Max Van - F(R) |
| | Kia Cee'd (JD) - F(L) | 3348015 | Ford C-Max II - F(L) |
| | Kia Cee'd Sportswagon (JD) - F(L) | | Ford Focus III - F(L) |
| | Kia ProCee'd (JD) - F(L) | | Ford Focus III Turnier - F(L) |
| 3340172 | Nissan Qashqai II (J11, J11_) - F(R) | 3348020 | Ford Grand C-Max, Grand C-Max Van - F(L) |
| | Renault Kadjar (HA_, HL_) - F(R) | | Audi A1 (8X1, 8XK), A1 Sportback (8XA, 8XF) - F |
| 3340173 | Nissan Qashqai II (J11, J11_) - F(L) | | Seat Ibiza IV (6J_, 6P_) - F |
| | Renault Kadjar (HA_, HL_) - F(L) | | Volkswagen Polo V (6R1, 6C1) - F |
| 3340194 | Hyundai Grand Santa Fe - F(R) | 3348023 | Nissan Pulsar - F(R) |
| | Hyundai Santa Fe III (DM) - F(R) | | Nissan Sentra (B17R) - F(R) |
| | Kia Sorento II (XM) - F(R) | 3348024 | Nissan Pulsar - F(L) |
| 3340195 | Hyundai Grand Santa Fe - F(L) | | Nissan Sentra (B17R) - F(L) |
| | Hyundai Santa Fe III (DM) - F(L) | 3348025 | BMW 2 Series (F22) - F(R) |
| | Kia Sorento II (XM) - F(L) | | BMW 3 Series (F30, F80) - F(R) |
| 3340211 | Mitsubishi Outlander III (GG2W) - F(R) | 3348026 | BMW 3 Series Touring (F31) - F(R) |
| 3340212 | Mitsubishi Outlander III (GG2W) - F(L) | | BMW 2 Series (F22) - F(L) |
| 3340213 | Chevrolet - Daewoo Trax - F(R) | | BMW 3 Series (F30, F80) - F(L) |
| | Opel Mokka / Mokka X (J13) - F(R) | 3348027 | BMW 3 Series Touring (F31) - F(L) |
| | Vauxhall Mokka / Mokka X (J13) - F(R) | | BMW 1 Series (F21, F20) - F |
| 3340214 | Chevrolet - Daewoo Trax - F(L) | | BMW 2 Series (F22) - F |
| | Opel Mokka / Mokka X (J13) - F(L) | | BMW 2 Series (F23) - F |
| | Vauxhall Mokka / Mokka X (J13) - F(L) | | BMW 3 Series (F30, F80) - F |
| 3340219 | Hyundai Sonata VI (YF) - F(R) | | BMW 3 Series Gran Turismo (F34) - F |
| 3340220 | Hyundai Sonata VI (YF) - F(L) | | BMW 3 Series Touring (F31) - F |
| 3340221 | Kia Cee'd (ED) - F(R) | | BMW 4 Series (F32) - F |
| | Kia Cee'd SW (ED) - F(R) | | BMW 4 Series (F33) - F |
| | Kia ProCee'd (ED) - F(R) | | BMW 4 Series Gran Coupe (F36) - F |
| 3340222 | Kia Cee'd (ED) - F(L) | 3348028 | BMW 1 Series (F21, F20) - F |
| | Kia Cee'd SW (ED) - F(L) | | BMW 2 Series (F22) - F |
| | Kia ProCee'd (ED) - F(L) | | BMW 2 Series (F23) - F |
| | | | BMW 3 Series (F30, F80) - F |
| | | | BMW 3 Series Touring (F31) - F |
| | | | BMW 4 Series (F32) - F |
| | | | BMW 4 Series (F33) - F |
| 3348000 Series | | | |
| 3348002 | Citroën C4 Picasso II, C4 Grand Picasso II - F | | |
| 3348003 | Fiat 500 L - F(R) | | |

NUMERICAL LISTING
 NUMERISCHE LISTE
 LISTE NUMERIQUE

Numerical List

| KYB | VEHICLE FAHRZEUG VEHICULE | KYB | VEHICLE FAHRZEUG VEHICULE |
|------------|---|------------|---|
| 3348028 | BMW 4 Series Gran Coupe (F36) - F | 3348055 | Honda Civic IX (FK) - F(L) |
| 3348032 | Ford B-Max (JK) - F(R) Ford Tourneo Courier (B460) - F(R) Ford Transit Courier (B460) - F(R) | 3348056 | Ford Fiesta VI (CB1, CCN) - F(R) |
| 3348033 | Ford B-Max (JK) - F(L) Ford Tourneo Courier (B460) - F(L) Ford Transit Courier (B460) - F(L) | 3348057 | Ford Fiesta VI (CB1, CCN) - F(L) |
| 3348036 | Peugeot 308 II, 308 II SW - F | 3348058 | Citroën C4 II (B7) - F(R) |
| 3348037 | Citroën DS5 - F(R) DS DS 5 - F(R) | 3348059 | Citroën C4 II (B7) - F(L) |
| 3348038 | Citroën DS5 - F(L) DS DS 5 - F(L) | 3348060 | Mercedes Benz A-Class (W176) - F(R) Mercedes Benz B-Class (W246, W242) - F(R) Mercedes Benz CLA-Class (C117) - F(R) |
| 3348039 | Audi A3 (8V1, 8VK), A3 Sportback (8VA, 8VF) - F Audi A3 Limousine (8VS, 8VM) - F Audi A3 Cabriolet (8V7, 8VE) - F Audi S3 (8V_) - F Seat Leon (5F1), Leon SC (5F5), Leon ST (5F8) - F Skoda Octavia III (5E3) - F Skoda Octavia III Combi (5E5) - F Volkswagen Golf Sportsvan (AM1, AN1) - F Volkswagen Golf VII (5G1, BQ1, BE1, BE2) - F Volkswagen Golf VII Variant (BA5, BV5) - F | 3348061 | Mercedes Benz CLA-Class Shooting Brake (X117) - F(R) Mercedes Benz A-Class (W176) - F(L) Mercedes Benz B-Class (W246, W242) - F(L) Mercedes Benz CLA-Class (C117) - F(L) Mercedes Benz CLA-Class Shooting Brake (X117) - F(L) |
| 3348041 | Ford Fiesta - F(R) Ford Fiesta VI (CB1, CCN) - F(R) | 3348062 | Mercedes Benz A-Class (W176) - F(R) Mercedes Benz B-Class (W246, W242) - F(R) Mercedes Benz CLA-Class (C117) - F(R) |
| 3348042 | Ford Fiesta - F(L) Ford Fiesta VI (CB1, CCN) - F(L) | 3348063 | Mercedes Benz CLA-Class Shooting Brake (X117) - F(R) Mercedes Benz A-Class (W176) - F(L) Mercedes Benz B-Class (W246, W242) - F(L) Mercedes Benz CLA-Class (C117) - F(L) Mercedes Benz CLA-Class Shooting Brake (X117) - F(L) |
| 3348043 | BMW 1 Series (F21, F20) - F(R) BMW 3 Series Gran Turismo (F34) - F(R) BMW 4 Series (F32) - F(R) BMW 4 Series (F33) - F(R) BMW 4 Series Gran Coupe (F36) - F(R) | 3348064 | Mercedes Benz A-Class (W176) - F(R) Mercedes Benz B-Class (W246, W242) - F(R) Mercedes Benz CLA-Class (C117) - F(R) Mercedes Benz CLA-Class Shooting Brake (X117) - F(R) |
| 3348044 | BMW 1 Series (F21, F20) - F(L) BMW 3 Series Gran Turismo (F34) - F(L) BMW 4 Series (F32) - F(L) BMW 4 Series (F33) - F(L) BMW 4 Series Gran Coupe (F36) - F(L) | 3348065 | Mercedes Benz A-Class (W176) - F(L) Mercedes Benz B-Class (W246, W242) - F(L) Mercedes Benz CLA-Class (C117) - F(L) Mercedes Benz CLA-Class Shooting Brake (X117) - F(L) Mercedes Benz GLA-Class (X156) - F(L) |
| 3348045 | BMW 1 Series (F21, F20) - F(R) BMW 2 Series (F22) - F(R) BMW 2 Series (F23) - F(R) | 3348066 | Fiat Panda (312_, 319_) - F(R) |
| 3348046 | BMW 1 Series (F21, F20) - F(L) BMW 2 Series (F22) - F(L) BMW 2 Series (F23) - F(L) | 3348067 | Fiat Panda (312_, 319_) - F(L) |
| 3348047 | Ford Kuga II (DM2) - F(R) | 3348074 | Audi A1 City Carver (GBH) - F Audi A1 Sportback (GBA) - F Seat Ibiza V (KJ1) - F Skoda Kamiq (NW4) - F Skoda Scala (NW1) - F Volkswagen Polo VI (AW1, BZ1) - F |
| 3348048 | Ford Kuga II (DM2) - F(L) | 3348075 | Renault Espace V (JR_) - F |
| 3348049 | Fiat Croma II (194) - F(R) Opel Signum - F(R) Opel Vectra C - F(R) Vauxhall Signum - F(R) Vauxhall Vectra C - F(R) | 3348076 | Fiat 500X (334_) - F(R) |
| 3348050 | Fiat Croma II (194) - F(L) Opel Signum - F(L) Opel Vectra C - F(L) Vauxhall Signum - F(L) Vauxhall Vectra C - F(L) | 3348077 | Fiat 500X (334_) - F(L) |
| 3348052 | Fiat Panda (312_, 319_) - F(R) | 3348078 | Fiat 500X (334_) - R(R) Jeep Renegade (BU, B1) - R(R) |
| 3348053 | Fiat Panda (312_, 319_) - F(L) | 3348079 | Fiat 500X (334_) - R(L) Jeep Renegade (BU, B1) - R(L) |
| 3348054 | Honda Civic IX (FK) - F(R) | 3348080 | Opel Corsa E (X15) - F(R) Vauxhall Corsa Mk IV (E) (X15) - F(R) |
| | | 3348081 | Opel Corsa E (X15) - F(L) Vauxhall Corsa Mk IV (E) (X15) - F(L) |
| | | 3348082 | Volvo XC60 I (156) - F(R) |
| | | 3348083 | Volvo XC60 I (156) - F(L) |
| | | 3348084 | Citroën Jumpy / Dispatch / Spacetourer (V_) - F Opel Vivaro C / Zafira Life (K0) - F Peugeot Expert / Traveller (V_) - F Toyota Proace (MDZ_) - F Toyota Proace Verso (MDY_) - F |

NUMERICAL LISTING
NUMERISCHE LISTE
LISTE NUMERIQUE

| KYB | VEHICLE FAHRZEUG VEHICULE | KYB | VEHICLE FAHRZEUG VEHICULE |
|------------|--|--|--|
| 3348085 | Vauxhall Vivaro C / Vivaro Life (K0) - F Citroën Jumpy / Dispatch / Spacetourer (V_) - F Opel Vivaro C / Zafira Life (K0) - F Peugeot Expert / Traveller (V_) - F Toyota Proace (MDZ_) - F Toyota Proace Verso (MDY_) - F Vauxhall Vivaro C / Vivaro Life (K0) - F | 335040 335041 335042 335043 335054 335055 | Toyota RAV 4 - F(R) Toyota RAV 4 - F(L) Kia Carnival / Sedona - F(R) Kia Carnival / Sedona - F(L) Subaru Tribeca - F(R) Subaru Tribeca - F(L) |
| 3348086 | Renault Talisman, Talisman Grandtour (LP_, KP_) - F | 335080 | Toyota Prius +, Grand Prius + - F(R) |
| 3348087 | Renault Mégane IV (B9A/M_) - F Renault Mégane IV Grandtour (K9A/M_) - F Renault Scénic IV, Grand Scénic IV (J9_, R9_) - F | 335081 335607▼ 335612▼ 335613▼ | Toyota Prius +, Grand Prius + - F(L) Volkswagen Transporter, Bus, Caravelle, Multivan - F Ford Kuga I - F(R) Ford Kuga I - F(L) |
| 3348090 | Audi A1 City Carver (GBH) - F Audi A1 Sportback (GBA) - F Seat Arona (KJ7) - F Skoda Kamiq (NW4) - F Skoda Scala (NW1) - F Volkswagen T-Cross (C11) - F | 335614 335800 335801 335802 335803 | Lancia Delta, Prisma (831) - F Ford Transit - F Lancia Kappa - F Lancia Kappa - R Fiat Talento (296) - F Nissan NV300 (X82) - F |
| 3348091 | Opel Grandland X (A18) - F Peugeot 3008 (M_) - F Peugeot 5008 II - F | | Nissan Primastar - F Opel Vivaro - F Opel Vivaro (X82) - F |
| 3348092 | Vauxhall Grandland X (A18) - F Renault Mégane IV (B9A/M_) - F Renault Mégane IV Grandtour (K9A/M_) - F | | Renault Trafic II - F Renault Trafic III (JG_, FG_, EG_) - F Vauxhall Vivaro - F Vauxhall Vivaro (X82) - F |
| 3348095 | Citroën C5 Aircross - F | | Ford Transit - F |
| 3348096 | Fiat 500 L (351_, 352_) - F(R) | 335804 | Ford Transit - F |
| 3348097 | Fiat 500 L (351_, 352_) - F(L) | 335805 | Ford Transit - F |
| 3348098 | Citroën C3 III (SX_, SY_) - F(R) | 335808 | Audi A3 (8P1), A3 (8P7) - F |
| 3348099 | Citroën C4 Cactus - F(R) | | Audi A3 Sportback (8PA) - F |
| 3348099 | Citroën C3 III (SX_, SY_) - F(L) | | Audi Q3 - F |
| 3348099 | Citroën C4 Cactus - F(L) | | Seat Alhambra - F |
| 3348100 | BMW 2 Series Active Tourer (F45) - F(R) | | Seat Altea, Altea XL - F |
| 3348100 | BMW 2 Series Gran Tourer (F46) - F(R) | | Seat Leon II - F |
| 3348100 | BMW X1 (F48) - F(R) | | Seat Toledo III - F |
| 3348100 | BMW X2 (F39) - F(R) | | Skoda Octavia II - F |
| 3348100 | Mini Countryman (F60) - F(R) | | Skoda Octavia II Combi - F |
| 3348101 | BMW 2 Series Active Tourer (F45) - F(L) | | Skoda Superb - F |
| 3348101 | BMW 2 Series Gran Tourer (F46) - F(L) | | Volkswagen Beetle - F |
| 3348101 | BMW X1 (F48) - F(L) | | Volkswagen Caddy, Caddy Maxi - F |
| 3348101 | BMW X2 (F39) - F(L) | | Volkswagen Caddy Life, Caddy Maxi Life - F |
| 3348101 | Mini Countryman (F60) - F(L) | | Volkswagen Caddy IV (SAB, SAJ, SAA, SAH) - F |
| 3348101 | | | Volkswagen Caddy Maxi IV (SAB, SAJ, SAA, SAH) - F |
| 3348101 | | | Volkswagen Caddy Alltrack (SAB, SAA) - F |
| 3348101 | | | Volkswagen Eos (1F7) - F |
| 3348101 | | | Volkswagen Golf Cabrio - F |
| 3348101 | | | Volkswagen Golf V - F |
| 3348101 | | | Volkswagen Golf V Plus - F |
| 3348101 | | | Volkswagen Golf V Variant - F |
| 3348101 | | | Volkswagen Golf VI - F |
| 3348101 | | | Volkswagen Golf VI Variant - F |
| 3348101 | | | Volkswagen Jetta V - F |
| 3348101 | | | Volkswagen Jetta VI - F |
| 3348101 | | | Volkswagen Passat - F |
| 3348101 | | | Volkswagen Passat (362, 365) - F |
| 3348101 | | | Volkswagen Passat CC - F |
| 3348101 | | | Volkswagen Scirocco - F |
| 3348101 | | | Volkswagen Sharan - F |
| 3348101 | | | Volkswagen Touran - F |
| 3348101 | | | |
| 3348101 | | | |
| 3348101 | | | |
| 3348101 | | | |
| 3348101 | | | |
| 3348101 | | | |
| 3348101 | | | |
| 3348101 | | | |
| 3348101 | | | |
| 3348101 | | | |
| 3348101 | | | |
| 3348101 | | | |
| 3348101 | | | |
| 3348101 | | | |
| 3348101 | | | |
| 3348101 | | | |

| NUMERICAL LISTING NUMERISCHE LISTE LISTE NUMERIQUE | | | |
|--|--|----------------|---|
| KYB | VEHICLE FAHRZEUG VEHICULE | KYB | VEHICLE FAHRZEUG VEHICULE |
| 335809 | Mercedes Benz Sprinter (901, 902, 903, 904) - F Volkswagen Transporter LT Series - F | 335921 | Saab 9-5 (YS3E) - F |
| 335810 | Mercedes Benz Sprinter (901, 902, 903, 904) - F Volkswagen Transporter LT Series - F | 335923▼ | Ford Mondeo - R |
| 335811 | BMW 5 Series (E39) - F(R) BMW 5 Series Touring (E39) - F(R) | 335924 | BMW X5 - F(R) |
| 335812 | BMW 5 Series (E39) - F(L) BMW 5 Series Touring (E39) - F(L) | 335925 | BMW X5 - F(L) |
| 335813 | Audi TT Coupé (8J3) - F Audi TT Roadster (8J9) - F | 335926 | Land Rover Freelander / Freelander Soft top - F(R) |
| 335815 | BMW 5 Series (E60) - F(R) | 335927 | Land Rover Freelander / Freelander Soft top - F(L) |
| 335816 | BMW 5 Series (E60) - F(L) | 335931 | Mercedes Benz Viano (W639) - F Mercedes Benz Vito - F |
| 335817 | BMW 5 Series Touring (E61) - F(R) | 335932 | Mercedes Benz CLK (209) - F |
| 335818 | BMW 5 Series Touring (E61) - F(L) | 335933 | Citroën C8 - F(R) Fiat Ulysse - F(R) Lancia Phedra - F(R) Peugeot 807 - F(R) |
| 335819 | Ford Transit - F | 335934 | Citroën C8 - F(L) Fiat Ulysse - F(L) Lancia Phedra - F(L) Peugeot 807 - F(L) |
| 335820 | Ford Transit - F | | |
| 335821 | Toyota Verso - F(R) | | |
| 335822 | Toyota Verso - F(L) | | |
| 335823 | Toyota Highlander - F(R) Toyota Verso - F(R) | | |
| 335824 | Toyota Highlander - F(L) Toyota Verso - F(L) | | |
| 335827 | Citroën Jumper / Relay - F Fiat Ducato - F Peugeot Boxer - F | | |
| 335829 | Land Rover Freelander / Freelander Soft top - F(R) | | |
| 335830 | Land Rover Freelander / Freelander Soft top - F(L) | | |
| 335831 | Land Rover Freelander / Freelander Soft top - R(R) | | |
| 335832 | Land Rover Freelander / Freelander Soft top - R(L) | | |
| 335833 | BMW X3 - F(R) | | |
| 335834 | BMW X3 - F(L) | | |
| 335835 | Nissan NV400 - F Opel Movano (B) - F Renault Master III - F Vauxhall Movano (B) - F | | |
| 335837 | Nissan NV400 - F Opel Movano (B) - F Renault Master III - F Vauxhall Movano (B) - F | | |
| 335839 | Volkswagen Transporter, Bus, Caravelle, Multivan - F Volkswagen Transporter VI, California VI (S_) - F Volkswagen Caravelle VI, Multivan VI (S_) - F | | |
| 335840 | Volkswagen Transporter, Bus, Caravelle, Multivan - F Volkswagen Transporter VI, California VI (S_) - F Volkswagen Caravelle VI, Multivan VI (S_) - F | | |
| 335842 | Mercedes Benz GLK (X204) - F | | |
| 335843 | Mercedes Benz GLK (X204) - F | | |
| 335844 | Chevrolet - Daewoo Captiva - F(R) Opel Antara - F(R) Vauxhall Antara - F(R) | | |
| 335845 | Chevrolet - Daewoo Captiva - F(L) Opel Antara - F(L) Vauxhall Antara - F(L) | | |
| 335918 | Ford Cougar - F | | |
| 335919 | Ford Cougar - R | | |
| 335920 | Mercedes Benz C-Class (203) - F Mercedes Benz CLK (209) - F | | |
| | | 3350000 Series | |
| | | 3350000 | Toyota RAV 4 (13-) - F(R) |
| | | 3350001 | Toyota RAV 4 (13-) - F(L) |
| | | 3350026 | Toyota Prius (_W5_) - F(R) |
| | | 3350027 | Toyota Prius (_W5_) - F(L) |
| | | 3350036 | Mitsubishi Eclipse Cross (GK_) - F(R) Mitsubishi Outlander III (GF_W, GG_W) - F(R) |
| | | 3350037 | Mitsubishi Eclipse Cross (GK_) - F(L) Mitsubishi Outlander III (GF_W, GG_W) - F(L) |
| | | 3350038 | Lexus NX (_Z1_) - F(R) Toyota RAV 4 IV (_A4_) - F(R) |
| | | 3350039 | Lexus NX (_Z1_) - F(L) Toyota RAV 4 IV (_A4_) - F(L) |
| | | 3350066 | Opel Antara A (L07) - F(R) Vauxhall Antara A (L07) - F(R) |
| | | 3350067 | Opel Antara A (L07) - F(L) Vauxhall Antara A (L07) - F(L) |
| | | 3358000 Series | |
| | | 3358000 | Skoda Yeti - F Volkswagen Passat (3G2, 3G5) (14-) - F Volkswagen Tiguan - F |
| | | 3358001 | BMW X1 - F(R) |
| | | 3358002 | BMW X1 - F(L) |
| | | 3358003 | BMW X1 - F(R) |
| | | 3358004 | BMW X1 - F(L) |
| | | 3358005 | Toyota Verso - F(R) |
| | | 3358006 | Toyota Verso - F(L) |
| | | 3358007 | Suzuki SX4 S-Cross - F(R) Suzuki Vitara (LY) - F(R) |
| | | 3358008 | Suzuki SX4 S-Cross - F(L) Suzuki Vitara (LY) - F(L) |
| | | 3358009▼ | Toyota Avensis - F(R) |
| | | 3358010▼ | Toyota Avensis - F(L) |
| | | 3358011 | Toyota Auris - F(R) Toyota Auris Touring Sports - F(R) |
| | | 3358012 | Toyota Auris - F(L) Toyota Auris Touring Sports - F(L) |
| | | 3358013 | Volvo S60 II (134) - F(R) |





NUMERICAL LISTING
 NUMERISCHE LISTE
 LISTE NUMERIQUE

| KYB | VEHICLE FAHRZEUG VEHICULE | KYB | VEHICLE FAHRZEUG VEHICULE |
|---------------|---|--|--|
| 3358014 | Volvo V60 (155, 157) - F(R) Volvo S60 II (134) - F(L) Volvo V60 (155, 157) - F(L) | 338108 338109 338112 | Hyundai Solaris IV - F(R) Hyundai Solaris IV - F(L) Dacia Logan (LS) - F |
| 3358015 | Audi A3 (8V1, 8VK), A3 Sportback (8VA, 8VF) - F Audi A3 Limousine (8VS, 8VM) - F Audi A3 Cabriolet (8V7, 8VE) - F Audi Q2 (GAB, GAG) - F Audi S3 (8V_) - F Seat Leon (5F1), Leon SC (5F5), Leon ST (5F8) - F Skoda Octavia III (5E3) - F Skoda Octavia III Combi (5E5) - F Skoda Superb III (3V3, 3V5) - F Volkswagen Arteon, Arteon Shooting Brake (3H_) - F Volkswagen Golf VII (5G1, BQ1, BE1, BE2) - F Volkswagen Golf VII Variant (BA5, BV5) - F Volkswagen Passat (3G2, CB2), Passat Variant (3G5, CB5) - F Volkswagen Passat Alltrack (3G5, CB5) - F Volkswagen Touran (5T1) - F Volkswagen T-Roc (A11) - F Volkswagen T-Roc (AC7) - F | 338700 338701 338712 338713 | Renault Logan (LS) - F Renault Kangoo - F Renault Twingo - F Renault M3gane II - F Renault M3gane II Grandtour - F Dacia Logan MCV I - F Dacia Sandero - F Renault Logan MCV - F Renault Sandero - F |
| 3358016 | Land Rover Discovery Sport (L550) - F(R) Land Rover Range Rover Evoque (L538) - F(R) | 338714 338715 338731 338732 338733 | Peugeot 307, 307 SW, 307 CC - F(R) Peugeot 307, 307 SW, 307 CC - F(L) Ford Fiesta VI - F(R) Ford Fiesta VI - F(L) Citroën Berlingo - F(R) |
| 3358017 | Land Rover Discovery Sport (L550) - F(L) Land Rover Range Rover Evoque (L538) - F(L) | 338734 | Peugeot Partner Tepee/Ranch , Partner/Ranch - F(R) Citroën Berlingo - F(L) Peugeot Partner Tepee/Ranch , Partner/Ranch - F(L) Citroën Berlingo - F(R) |
| 3358018 | Land Rover Range Rover Evoque (L538) - R(R) | 338735 | Peugeot Partner Tepee/Ranch , Partner/Ranch - F(R) Citroën Berlingo - F(L) Peugeot Partner Tepee/Ranch , Partner/Ranch - F(L) |
| 3358019 | Land Rover Range Rover Evoque (L538) - R(L) | 338736 | Dacia Duster - F Dacia Duster (HM) - F Renault Captur (H5_) - F Renault Duster - F Renault Duster (HM) - F |
| 3358020 | Audi Q3 (F3B), Q3 Sportback (F3N) - F Seat Tarraco (KN2) - F Skoda Kodiaq (NS7, NV7) - F Volkswagen Tiguan (AD1, AX1) - F Volkswagen Tiguan Allspace (BW2, BJ2) - F | 338737 | Dacia Duster - R Dacia Duster (HM) - R Renault Captur (H5_) - R Renault Duster - R Renault Duster (HM) - R |
| 3358021 | Audi TT Coupé (FV3) - F Audi TT Roadster (FV9) - F | 338738 | Dacia Logan II - F Dacia Logan MCV II - F Dacia Sandero II - F Dacia Sandero Stepway II - F Renault Logan II - F Renault Logan MCV II - F Renault Sandero II - F Renault Sandero Stepway II (B8_) - F Renault Thalia III, Symbol III (L8_) - F |
| 3358026 | Mercedes Benz Viano (W639) - F Mercedes Benz Vito (W639) - F | 338749 | Dacia Logan II - F Dacia Logan MCV II - F Dacia Sandero II - F Dacia Sandero Stepway II - F Renault Logan II - F Renault Logan MCV II - F Renault Sandero II - F Renault Sandero Stepway II (B8_) - F Renault Thalia III, Symbol III (L8_) - F |
| 338000 Series | | | |
| 338001 | Honda Jazz - F(R) | | |
| 338002 | Honda Jazz - F(L) | | |
| 338015 | Daihatsu Materia - F(R) | | |
| 338016 | Daihatsu Materia - F(L) | | |
| 338022 | Hyundai Elantra - F(R) | | |
| 338023 | Hyundai Elantra - F(L) | | |
| 338024 | Hyundai i30 - F(R) Hyundai i30 CW - F(R) | 338759 | Dacia Logan II - F Dacia Logan MCV II - F Dacia Sandero II - F Dacia Sandero Stepway II - F Renault Logan II - F Renault Logan MCV II - F Renault Sandero II - F Renault Sandero Stepway II (B8_) - F Renault Thalia III, Symbol III (L8_) - F |
| 338025 | Hyundai i30 - F(L) Hyundai i30 CW - F(L) | | |
| 338026 | Kia Cerato II - F(R) | | |
| 338027 | Kia Cerato II - F(L) | | |
| 338064 | Suzuki Swift IV - F(R) | | |
| 338065 | Suzuki Swift IV - F(L) | | |
| 338087 | Mazda Mazda 3 - F(R) | | |
| 338088 | Mazda Mazda 3 - F(L) | | |
| 338106 | Hyundai Accent, Pony, Excel - F(R) Kia Rio III - F(R) | | |
| 338107 | Hyundai Accent, Pony, Excel - F(L) Kia Rio III - F(L) | 339021 339022 339023 | Daihatsu Terios - F(R) Daihatsu Terios - F(L) Toyota Camry - F(R) |
| | | 339000 Series | |

Numerical List

NUMERICAL LISTING
 NUMERISCHE LISTE
 LISTE NUMERIQUE

Numerical List

|  | VEHICLE FAHRZEUG VEHICULE |  | VEHICLE FAHRZEUG VEHICULE |
|--|---|---|--|
| 339024 | Toyota Camry - F(L) | 339238 | Subaru Legacy - F(R) |
| 339025 | Toyota Camry - R(R) | 339239 | Subaru Legacy - F(L) |
| 339026 | Toyota Camry - R(L) | 339240 | Subaru Outback - F(R) |
| 339029 | Chevrolet - Daewoo Lacetti / Optra / Genra - F(R) | 339241 | Subaru Outback - F(L) |
| | Chevrolet - Daewoo Nubira III - F(R) | 339242 | Toyota Prius (Hybrid) - F(R) |
| 339030 | Chevrolet - Daewoo Lacetti / Optra / Genra - F(L) | 339243 | Toyota Prius (Hybrid) - F(L) |
| | Chevrolet - Daewoo Nubira III - F(L) | 339247 | Chrysler Sebring - F(R) |
| 339031 | Toyota RAV 4 - F(R) | 339248 | Chrysler Sebring - F(L) |
| 339032 | Toyota RAV 4 - F(L) | 339249 | Chrysler Journey - F(R) |
| 339074 | Honda Civic - F(R) | | Fiat Freemont (JC) - F(R) |
| 339075 | Honda Civic - F(L) | 339250 | Chrysler Journey - F(L) |
| 339080 | Citroën C-Crosser - F(R) | | Fiat Freemont (JC) - F(L) |
| | Mitsubishi Outlander - F(R) | 339253 | Citroën C4 Aircross - F(R) |
| | Peugeot 4007 - F(R) | | Mitsubishi ASX - F(R) |
| 339081 | Citroën C-Crosser - F(L) | | Peugeot 4008 - F(R) |
| | Mitsubishi Outlander - F(L) | 339254 | Citroën C4 Aircross - F(L) |
| | Peugeot 4007 - F(L) | | Mitsubishi ASX - F(L) |
| 339082 | Mitsubishi Lancer, Lancer Sportback - F(R) | | Peugeot 4008 - F(L) |
| 339083 | Mitsubishi Lancer, Lancer Sportback - F(L) | 339257 | Kia Cee'd, Pro Cee'd, Cee'd SW - F(R) |
| 339086 | Toyota Camry - F(R) | 339258 | Kia Cee'd, Pro Cee'd, Cee'd SW - F(L) |
| 339087 | Toyota Camry - F(L) | 339261 | Honda CR-V - F(R) |
| 339104 | Mitsubishi Lancer, Lancer Sportback - F(R) | 339262 | Honda CR-V - F(L) |
| 339105 | Mitsubishi Lancer, Lancer Sportback - F(L) | 339265 | Suzuki Kizashi - F(R) |
| 339117 | Mitsubishi Lancer, Lancer Sportback - F(R) | 339266 | Suzuki Kizashi - F(L) |
| 339118 | Mitsubishi Lancer, Lancer Sportback - F(L) | 339267 | Toyota Urban Cruiser - F(R) |
| 339124 | Mitsubishi Outlander II - F(R) | 339268 | Toyota Urban Cruiser - F(L) |
| 339125 | Mitsubishi Outlander II - F(L) | 339269 | BMW 3 Series (E90) - F(R) |
| 339134 | Toyota Urban Cruiser - F(R) | | BMW 3 Series (E92) - F(R) |
| | Toyota Verso S - F(R) | | BMW 3 Series (E93) - F(R) |
| 339135 | Toyota Urban Cruiser - F(L) | | BMW 3 Series Touring (E91) - F(R) |
| | Toyota Verso S - F(L) | 339270 | BMW 3 Series (E90) - F(L) |
| 339140 | Mazda CX-9 - F(R) | | BMW 3 Series (E92) - F(L) |
| 339141 | Mazda CX-9 - F(L) | | BMW 3 Series (E93) - F(L) |
| 339149 | Subaru Forester - R(R) | | BMW 3 Series Touring (E91) - F(L) |
| 339150 | Subaru Forester - R(L) | 339271 | Chrysler Voyager / Mini-Van, Town & Country, Caravan - F |
| 339155 | Mazda CX-7 - F(R) | 339279 | Honda Civic - F(R) |
| 339156 | Mazda CX-7 - F(L) | 339280 | Honda Civic - F(L) |
| 339169 | Subaru Forester - F(R) | 339281 | Lexus RX - F(R) |
| 339170 | Subaru Forester - F(L) | 339282 | Lexus RX - F(L) |
| 339171 | Subaru Impreza (GR) - F(R) | 339309 | Kia Carnival / Sedona - F(R) |
| 339172 | Subaru Impreza (GR) - F(L) | 339310 | Kia Carnival / Sedona - F(L) |
| 339188 | Nissan Murano II (Z51) - F(R) | 339311 | Nissan Murano II (Z51) - F(R) |
| 339189 | Nissan Murano II (Z51) - F(L) | 339312 | Nissan Murano II (Z51) - F(L) |
| 339196 | Nissan Qashqai - F(R) | 339313 | Suzuki SX4 - F(R) |
| | Nissan Qashqai + 2 - F(R) | 339314 | Suzuki SX4 - F(L) |
| 339197 | Nissan Qashqai - F(L) | 339334 | Toyota RAV 4 IV (_A4_) - F(R) |
| | Nissan Qashqai + 2 - F(L) | 339335 | Toyota RAV 4 IV (_A4_) - F(L) |
| 339198 | Nissan X-Trail - F(R) | 339336 | Mazda CX-5 - F(R) |
| | Renault Koleos - F(R) | 339337 | Mazda CX-5 - F(L) |
| 339199 | Nissan X-Trail - F(L) | 339344 | Lancia Voyager - F |
| | Renault Koleos - F(L) | 339351 | Toyota Aurion - F(R) |
| 339202 | Honda Civic - F(R) | | Toyota Camry - F(R) |
| 339203 | Honda Civic - F(L) | 339352 | Toyota Aurion - F(L) |
| 339208 | Lexus RX - R(R) | | Toyota Camry - F(L) |
| 339209 | Lexus RX - R(L) | 339371 | Opel Astra - F(R) |
| 339226 | Subaru Impreza (GR) - F(R) | | Opel Zafira Tourer C - F(R) |
| 339227 | Subaru Impreza (GR) - F(L) | | Vauxhall Astra - F(R) |

NUMERICAL LISTING
 NUMERISCHE LISTE
 LISTE NUMERIQUE

| KYB | VEHICLE FAHRZEUG VEHICULE | KYB | VEHICLE FAHRZEUG VEHICULE |
|------------|---|------------|--|
| 339372 | Vauxhall Zafira Tourer C - F(R) Opel Astra - F(L) Opel Zafira Tourer C - F(L) Vauxhall Astra - F(L) | 339700 | Toyota Auris - F(R) Toyota Auris Touring Sports - F(R) Toyota Corolla - F(R) |
| 339373 | Vauxhall Zafira Tourer C - F(L) GM Orlando - F(R) Opel Astra - F(R) Opel Zafira Tourer C - F(R) Vauxhall Astra - F(R) Vauxhall Zafira Tourer C - F(R) GM Orlando - F(L) Opel Astra - F(L) Opel Zafira Tourer C - F(L) Vauxhall Astra - F(L) Vauxhall Zafira Tourer C - F(L) | 339701 | Toyota Auris - F(L) Toyota Auris Touring Sports - F(L) Toyota Corolla - F(L) |
| 339374 | Opel Insignia - F(R) Opel Insignia Sport Tourer - F(R) Vauxhall Insignia - F(R) Vauxhall Insignia Sports Tourer - F(R) Opel Insignia - F(L) Opel Insignia Sport Tourer - F(L) Vauxhall Insignia - F(L) Vauxhall Insignia Sports Tourer - F(L) | 339702 | Opel Astra - F(R) Opel Zafira II - F(R) Vauxhall Astra - F(R) Vauxhall Zafira II - F(R) |
| 339375 | Saab 9-5 (YS3G) - F(R) | 339703 | Opel Astra - F(L) Opel Zafira II - F(L) Vauxhall Astra - F(L) Vauxhall Zafira II - F(L) |
| 339376 | Saab 9-5 (YS3G) - F(L) | 339704 | Renault Laguna III - F |
| 339377 | Saab 9-5 (YS3G) - F(L) | 339707 | Citroën DS3 - F(R) DS DS 3 (SA_, SB_) - F(R) Peugeot 207 - F(R) Peugeot 207 CC - F(R) Peugeot 207 SW - F(R) |
| 339378 | Saab 9-5 (YS3G) - F(L) | 339708 | Citroën DS3 - F(L) DS DS 3 (SA_, SB_) - F(L) Peugeot 207 - F(L) Peugeot 207 CC - F(L) Peugeot 207 SW - F(L) |
| 339379 | Saab 9-5 (YS3G) - F(R) | 339709 | Peugeot 207 - F(R) Peugeot 207 SW - F(R) |
| 339380 | Saab 9-5 (YS3G) - F(L) | 339710 | Peugeot 207 - F(L) |
| 339381 | Chevrolet - Daewoo Cruze (J300), Cruze (J305) - F(R) Chevrolet - Daewoo Cruze Station Wagon (J308) - F(R) | 339711 | Peugeot 207 - F(L) |
| 339382 | Chevrolet - Daewoo Cruze (J300), Cruze (J305) - F(L) Chevrolet - Daewoo Cruze Station Wagon (J308) - F(L) | 339714 | Opel Adam - F(R) Opel Corsa D - F(R) Opel Corsa E, Corsa E Van - F(R) Vauxhall Adam - F(R) Vauxhall Corsa Mk III - F(R) Vauxhall Corsa Mk IV, Corsavan Mk IV - F(R) |
| 339387 | Subaru Impreza (GP, GJ) - F(R) | 339715 | Opel Adam - F(L) Opel Corsa D - F(L) Opel Corsa E, Corsa E Van - F(L) Vauxhall Adam - F(L) Vauxhall Corsa Mk III - F(L) Vauxhall Corsa Mk IV, Corsavan Mk IV - F(L) |
| 339388 | Subaru Impreza (GP, GJ) - F(L) | 339716 | Opel Corsa D - F(R) Vauxhall Corsa Mk III - F(R) |
| 339402 | Hyundai ix35 - F(R) Kia Sportage - F(R) | 339717 | Opel Corsa D - F(L) Vauxhall Corsa Mk III - F(L) |
| 339403 | Hyundai ix35 - F(L) Kia Sportage - F(L) | 339718 | Ford Mondeo - F(R) Volvo S 80 II - F(R) Volvo V 70 III - F(R) Volvo XC 70 II - F(R) |
| 339404 | Mazda Mazda 6 - F(R) | 339719 | Ford Mondeo - F(L) Volvo S 80 II - F(L) Volvo V 70 III - F(L) Volvo XC 70 II - F(L) |
| 339405 | Mazda Mazda 6 - F(L) | 339720 | Ford Galaxy - F(R) Ford S-Max - F(R) |
| 339406 | Nissan Leaf - F(R) Nissan Leaf (ZE1) - F(R) | 339721 | Ford Galaxy - F(L) Ford S-Max - F(L) |
| 339407 | Nissan Leaf - F(L) Nissan Leaf (ZE1) - F(L) | | |
| 339412 | Subaru Impreza (GP_) - F(R) Subaru XV - F(R) | | |
| 339413 | Subaru Impreza (GP_) - F(L) Subaru XV - F(L) | | |
| 339418 | Chevrolet - Daewoo Cruze (J300), Cruze (J305) - F(R) Chevrolet - Daewoo Cruze Station Wagon (J308) - F(R) Opel Astra - F(R) Vauxhall Astra - F(R) | | |
| 339419 | Chevrolet - Daewoo Cruze (J300), Cruze (J305) - F(L) Chevrolet - Daewoo Cruze Station Wagon (J308) - F(L) Opel Astra - F(L) Vauxhall Astra - F(L) | | |
| 339420 | Saab 9-5 (YS3G) - F(R) | | |
| 339421 | Saab 9-5 (YS3G) - F(L) | | |

NUMERICAL LISTING
 NUMERISCHE LISTE
 LISTE NUMERIQUE

Numerical List

| KYB | VEHICLE FAHRZEUG VEHICULE | KYB | VEHICLE FAHRZEUG VEHICULE |
|------------|---|------------|-------------------------------------|
| 339722 | Honda Civic - F(R) | 339771 | Citroën Jumpy / Dispatch - F(R) |
| 339723 | Honda Civic - F(L) | | Fiat Scudo (270) - F(R) |
| 339724 | Renault Mégane III - F | | Peugeot Expert - F(R) |
| | Renault Mégane III Grandtour - F | 339772 | Citroën Jumpy / Dispatch - F(L) |
| 339727 | BMW 3 Series (E46) - F(R) | | Fiat Scudo (270) - F(L) |
| | BMW 3 Series Touring (E46) - F(R) | | Peugeot Expert - F(L) |
| 339728 | BMW 3 Series (E46) - F(L) | 339774 | Fiat Linea (323) - F(R) |
| | BMW 3 Series Touring (E46) - F(L) | 339775 | Fiat Linea (323) - F(L) |
| 339729 | Fiat Stilo (192) - F | 339785 | Lancia Delta - F |
| | Fiat Stilo Multi Wagon (192) - F | 339786 | Lancia Delta - F |
| 339730 | Fiat Stilo (192) - F | 339787 | BMW X5 - F |
| | Fiat Stilo Multi Wagon (192) - F | | BMW X6 - F |
| 339731 | Fiat Bravo II - F | 339788 | Fiat Doblo (152) - F(R) |
| 339732 | Fiat Bravo II - F | | Fiat Doblo Cargo (263) - F(R) |
| 339734 | Renault Espace - F | 339789 | Fiat Doblo (152) - F(L) |
| 339735 | Ford Kuga I - F(R) | | Fiat Doblo Cargo (263) - F(L) |
| 339736 | Ford Kuga I - F(L) | 339790 | Chevrolet - Daewoo Epica - F(R) |
| 339737 | Fiat Panda (169) - F(R) | 339791 | Chevrolet - Daewoo Epica - F(L) |
| 339738 | Fiat Panda (169) - F(L) | 339794 | Citroën C3 II - F(R) |
| 339739 | Fiat Panda (169) - F(R) | | Citroën DS3 - F(R) |
| 339740 | Fiat Panda (169) - F(L) | | DS DS 3 (SA_, SB_) - F(R) |
| 339741 | Audi A1 (8X1), A1 Sportback (8XA) - F | 339795 | Citroën C3 II - F(L) |
| | Seat Ibiza V - F | | Citroën DS3 - F(L) |
| | Volkswagen Polo - F | | DS DS 3 (SA_, SB_) - F(L) |
| | Volkswagen Polo V (602, 604, 612, 614) - F | 339797 | Renault Fluence - F |
| 339742 | Hyundai Tucson - F(R) | 339800 | Citroën C3 II - F(R) |
| | Kia Sportage - F(R) | | Citroën DS3 - F(R) |
| 339743 | Hyundai Tucson - F(L) | | DS DS 3 (SA_, SB_) - F(R) |
| | Kia Sportage - F(L) | 339801 | Citroën C3 II - F(L) |
| 339744 | Alfa Romeo Alfa 147 - R | | Citroën DS3 - F(L) |
| 339745 | Alfa Romeo Alfa 156 - R | | DS DS 3 (SA_, SB_) - F(L) |
| | Alfa Romeo Alfa 156 Sportwagon - R | 339802 | Citroën C3 II - F(R) |
| 339746 | Hyundai Tucson - R(R) | | Citroën C4 Cactus - F(R) |
| | Kia Sportage - R(R) | 339803 | Citroën C3 II - F(L) |
| 339747 | Hyundai Tucson - R(L) | | Citroën C4 Cactus - F(L) |
| | Kia Sportage - R(L) | 339804 | Citroën C3 II - F(R) |
| 339748 | Hyundai Santa Fe - F(R) | | Citroën DS3 - F(R) |
| 339749 | Hyundai Santa Fe - F(L) | 339805 | Citroën C3 II - F(L) |
| 339750 | Hyundai Santa Fe - F(R) | | Citroën DS3 - F(L) |
| 339751 | Hyundai Santa Fe - F(L) | 339806 | Citroën C4 II - F(R) |
| 339754 | Nissan Juke - F(R) | | Peugeot 5008 - F(R) |
| 339755 | Nissan Juke - F(L) | 339807 | Citroën C4 II - F(L) |
| 339756 | Toyota Yaris III - F(R) | | Peugeot 5008 - F(L) |
| 339757 | Toyota Yaris III - F(L) | 339808 | Citroën Nemo Combi, Nemo - F(R) |
| 339758 | Ford Mondeo - F | | Fiat Fiorino Qubo, Fiorino - F(R) |
| 339759 | Ford Mondeo - R | | Peugeot Bipper Tepee, Bipper - F(R) |
| 339760 | Alfa Romeo Mito - F(R) | 339809 | Citroën Nemo Combi, Nemo - F(L) |
| 339761 | Alfa Romeo Mito - F(L) | | Fiat Fiorino Qubo, Fiorino - F(L) |
| 339762 | Renault Scénic III, Grand Scénic III - F | | Peugeot Bipper Tepee, Bipper - F(L) |
| 339763 | Audi A1 (8X1), A1 Sportback (8XA) - F | 339816 | Toyota Avensis - F(R) |
| | Seat Ibiza V - F | 339817 | Toyota Avensis - F(L) |
| | Skoda Fabia III (NJ3, NJ5) - F | 339818 | Volvo XC 60 - F(R) |
| | Skoda Rapid, Rapid Spaceback (NH_, NK_) - F | 339819 | Volvo XC 60 - F(L) |
| | Volkswagen Polo - F | 339820 | Mazda Mazda 5 - F(R) |
| | Volkswagen Polo V (602, 604, 612, 614) - F | 339821 | Mazda Mazda 5 - F(L) |
| 339766 | Mercedes Benz Citan - F | 339826 | Opel Meriva B - F(R) |
| | Renault Kangoo - F | | Vauxhall Meriva B - F(R) |



NUMERICAL LISTING
 NUMERISCHE LISTE
 LISTE NUMERIQUE

| KYB | VEHICLE FAHRZEUG VEHICULE | KYB | VEHICLE FAHRZEUG VEHICULE |
|---|--|----------------------|--|
| 339827 | Opel Meriva B - F(L) | 341000 Series | |
| 339828 | Vauxhall Meriva B - F(L) Citroën C4 II (B7) - F(R) Citroën DS4 - F(R) DS DS 4 - F(R) Peugeot 3008 - F(R) | 341002 | Mercedes Benz W Series (W114, W115) - F |
| 339829 | Citroën C4 II (B7) - F(L) Citroën DS4 - F(L) DS DS 4 - F(L) Peugeot 3008 - F(L) | 341003 | Audi 80/90, 80 Variant/Avant [78-91] - R Audi Coupé - R |
| 339830 | Alfa Romeo Mito - F(R) | 341007 | Volkswagen Golf Cabrio - R Volkswagen Golf I, Jetta I - R Volkswagen Scirocco - R |
| 339831 | Alfa Romeo Mito - F(L) | 341015▼ | BMW 3 Series (E21) - R |
| 339832 | Alfa Romeo Mito - F(R) | 341016▼ | Audi 100, 100 Avant - R |
| 339833 | Alfa Romeo Mito - F(L) | 341023▼ | Audi 200, 200 Avant - R Audi 50 - R |
| 339850 | Alfa Romeo Giulietta - F(L) | 341044 | Volkswagen Polo, Derby - R |
| 339851 | Alfa Romeo Giulietta - F(R) | 341048 | Ford Sierra, XR-4, Cosworth - R |
| 339852 | Mercedes Benz A-Class - F | 341048 | Toyota Starlet - R |
| 339853 | Mercedes Benz B-Class (W245) - F | 341050 | Honda Civic CR-X / Ballade CR-X - R Honda Civic, Ballade - R Rover 200 Series - R |
| Excel-G Shock Absorber (34 - Series) | | 341051▼ | Nissan Laurel - R |
| 340000 Series | | 341052▼ | Nissan Laurel - R |
| 340015 | Mazda BT-50 - F | 341054 | Mitsubishi Galant, Sapporo (Lambda), Sigma - R |
| 340016 | Mazda BT-50 - R | 341056▼ | Nissan Micra, March - R |
| 340023 | Mazda BT-50 - F | 341058 | Renault R 5 (Super 5) - R |
| 340025 | Alfa Romeo Alfa 147 - F Alfa Romeo Alfa 156 - F Alfa Romeo Alfa 156 Sportwagon - F Alfa Romeo GT - F | 341062 | Renault R 5 (Super 5) - R |
| 340031 | Honda Accord/ Vigor - R | 341062 | Honda Prelude - F |
| 340033 | Mitsubishi L 200 - F | 341068 | Renault R 5 (Super 5) - R |
| 340034 | Mitsubishi Pajero Sport / Montero Sport - F | 341070 | Toyota Celica Supra, Supra - R |
| 340035 | Honda FR-V - R | 341072 | Honda Accord/ Vigor - F(R) Honda Prelude - F(R) |
| 340036 | Honda Accord/ Vigor - F(R) | 341073 | Honda Accord/ Vigor - F(L) Honda Prelude - F(L) |
| 340037 | Honda Accord/ Vigor - F(L) | 341074▼ | Honda Accord/ Vigor - R |
| 340042 | Subaru Legacy - R | 341077▼ | Honda Civic Shuttle / Ballade Shuttle - R |
| 340043 | Subaru Legacy - R | 341079 | Kia Pride - R |
| 340045 | Kia Sorento - F(R) | 341080 | Mazda 121 - R |
| 340046 | Kia Sorento - F(L) | 341080 | BMW 5 Series (E28) - R |
| 340057 | Subaru Outback - R | 341081 | BMW 5 Series (E34) - R |
| 340060 | Citroën C4 Aircross - R Mitsubishi ASX - R Peugeot 4008 - R | 341082 | Toyota Starlet - R |
| 340062 | Toyota Land Cruiser - F | 341084 | Mitsubishi Colt - R Mitsubishi Lancer - R |
| 340068 | Chrysler Sebring - R | 341085 | Honda Civic CR-X / Ballade CR-X - F(R) Honda Civic, Ballade - F(R) |
| 340076 | Chrysler Caliber - R | 341086 | Honda Civic CR-X / Ballade CR-X - F(L) Honda Civic, Ballade - F(L) |
| 340085 | Toyota Land Cruiser (_J15_) - F Toyota Land Cruiser Prado (_J15_) - F | 341087 | Honda Civic CR-X / Ballade CR-X - F(R) Honda Civic, Ballade - F(R) |
| 340093 | Fiat Freemont (JC) - R | 341088 | Honda Civic CR-X / Ballade CR-X - F(L) Honda Civic, Ballade - F(L) |
| 340096 | Subaru Impreza (GP, GJ) - R | 341091▼ | Honda Civic Shuttle / Ballade Shuttle - F(R) |
| 340103 | Mitsubishi Outlander II - R | 341092▼ | Honda Civic Shuttle / Ballade Shuttle - F(L) |
| 340106 | Ford - Mercury Ranger (TKE) - F | 341093 | Honda Civic CR-X / Ballade CR-X - R Honda Civic, Ballade - R |
| 340115 | Honda CR-V - R | 341094 | Honda Civic Coupé / Ballade Coupé - R Honda Civic CR-X / Ballade CR-X - R Honda Civic, Ballade - R |
| 340116 | Subaru XV - R | 341095 | Honda Civic Shuttle / Ballade Shuttle - R |
| 340125 | Toyota Land Cruiser - F | 341096▼ | Honda Civic Shuttle / Ballade Shuttle - R |
| | | 341099 | Nissan Silvia, 200 SX - R |
| | | 341100 | Renault R 21 - R |



Numerical List

NUMERICAL LISTING
 NUMERISCHE LISTE
 LISTE NUMERIQUE

Numerical List

| KYB | VEHICLE FAHRZEUG VEHICULE | KYB | VEHICLE FAHRZEUG VEHICULE |
|------------|--|------------|--|
| 341101 | Citroën AX - R Citroën Saxo - R Peugeot 106 I, 106 II - R | 341167 | Mazda 121 - R |
| 341102 | Citroën Xsara Picasso - R Peugeot 405 - R | 341171 | Honda Accord/Vigor - F(R) Rover 600 Series - F(R) |
| 341110 | Renault Espace - F | 341172 | Honda Accord/Vigor - F(L) Rover 600 Series - F(L) |
| 341112 | Honda Legend - F(R) | 341173 | Honda Accord/Vigor - R Rover 600 Series - R |
| 341113 | Honda Legend - F(L) | 341174 | Honda Accord/Vigor - F(R) |
| 341114 | Mitsubishi Eclipse - R Mitsubishi Lancer - R | 341175 | Honda Accord/Vigor - F(L) |
| 341115 | Renault R 5 (Super 5) Express, Rapide, Extra - R | 341176 | Honda Accord/Vigor - R |
| 341116 | Honda Legend - R | 341177 | Honda Prelude - F(R) |
| 341120 | Nissan Primera - F Nissan Primera Traveller - F | 341178 | Honda Prelude - F(L) |
| 341127 | Mazda MX-5 - R | 341179 | Honda Prelude - R |
| 341129 | BMW 7 Series (E32) - R | 341180 | Honda Prelude - R |
| 341130 | Audi 80, 80 Variant/Avant [91-95] - R | 341183 | Mitsubishi 3000 GT, GTO - R |
| 341131 | Honda Civic, Ballade - R Honda Concerto - R Rover 200 Series - R Rover 400 Series - R Rover 45, ZS - R | 341186 | Nissan Almera (N15) - R |
| 341132▼ | Audi 80, 80 Variant/Avant [91-95] - R | 341187 | Auto Bianchi Y 10 - R Lancia Y10 - R |
| 341133 | Audi 100, 100 Avant - R Audi A6 (4A), A6 Avant (4A) - R | 341189 | Fiat Cinquecento (170) - R Fiat Seicento (187) - R Fiat Seicento Van (187) - R |
| 341134 | Mitsubishi Sigma - R | 341190 | Kia Sportage - F |
| 341138 | Honda Civic Coupé / Ballade Coupé - F(R) Honda Civic CR-X / Ballade CR-X - F(R) Honda Civic, Ballade - F(R) | 341191 | Toyota Paseo - R Toyota Starlet - R |
| 341139 | Honda Civic Coupé / Ballade Coupé - F(L) Honda Civic CR-X / Ballade CR-X - F(L) Honda Civic, Ballade - F(L) | 341192 | Hyundai Sonata / Sonica - R |
| 341140 | Mitsubishi Colt - R Mitsubishi FTO - R Mitsubishi Lancer - R Proton Coupé - R Proton Persona Compact, 300 Series - R Proton Persona, 400 Series, Wira - R | 341195 | Peugeot 605 - R Peugeot 607 - R |
| 341141 | Mitsubishi Galant, Sapporo (Lambda), Sigma - F | 341198 | Honda Civic Coupé / Ballade Coupé - R Honda Civic, Ballade - R |
| 341142 | Mitsubishi Galant, Sapporo (Lambda), Sigma - R | 341200 | Honda Shuttle / Odyssey - F(R) |
| 341143 | Mazda MX-5 - F | 341201 | Honda Shuttle / Odyssey - F(L) |
| 341145 | Mitsubishi Colt - R Mitsubishi Lancer - R Volvo S 40, V 40 - R | 341202 | Nissan Maxima, QX - R |
| 341146 | BMW 5 Series Touring (E34) - R | 341203 | Honda Civic Coupé / Ballade Coupé - F Honda Civic, Ballade - F |
| 341147 | Hyundai Lantra - R | 341204 | Mitsubishi Carisma - R Mitsubishi Space Star - R Volvo S 40, V 40 - R |
| 341148 | Renault Clio I - R | 341205 | Audi 100, 100 Avant - R Audi 200, 200 Avant - R Audi A6 (4A), A6 Avant (4A) - R |
| 341153 | Audi Coupé - R | 341206 | Audi 100, 100 Avant - R Audi 200, 200 Avant - R Audi A6 (4A), A6 Avant (4A) - R Audi V8 - R |
| 341154▼ | Hyundai Sonata / Sonica - R | 341208 | Rover 200 Series - R Rover 25 - R |
| 341156 | Rover 800 Series - F | 341209 | Auto Bianchi Y 10 - R Fiat Panda (141) - R Lancia Y10 - R |
| 341159 | Lexus LS400 - F | 341210 | Auto Bianchi Y 10 - R Fiat Panda (141) - R Lancia Y10 - R |
| 341163 | Mitsubishi Eclipse - F | 341211 | BMW 7 Series (E38) - R |
| 341165 | Mitsubishi Eclipse - R | 341212 | Fiat Panda (141) - R Seat Panda, Marbella - R Seat Terra, Trans - R |
| 341166 | Citroën Xsara (N1/N0) - R Citroën Xsara (N2) - R Citroën ZX - R Peugeot 306 - R | 341213 | Mitsubishi Galant, Sapporo (Lambda), Sigma - R |

NUMERICAL LISTING
 NUMERISCHE LISTE
 LISTE NUMERIQUE

|  | VEHICLE FAHRZEUG VEHICULE |  | VEHICLE FAHRZEUG VEHICULE |
|---|--|---|---|
| 341214▼ | Subaru L Series, Leone - R | 341277 | Toyota Celica - R |
| 341216▼ | Subaru L Series, Leone - R | 341278 | Toyota Celica - R |
| 341217 | Volvo S 40, V 40 - R | 341279 | Nissan Almera (N16) - R |
| 341218 | Rover 400 Series - F(R) | | Nissan Almera Classic - R |
| 341219 | Rover 400 Series - F(L) | 341280 | Hyundai Sonata / Sonica - F |
| 341222 | Nissan Silvia, 200 SX - R | | Hyundai XG - F |
| 341226 | Nissan Almera (N15) - R | | Kia Magentis - F |
| 341227 | Nissan Primera - R | 341281 | Hyundai Sonata / Sonica - R |
| 341228 | Nissan Primera - R | | Hyundai XG - R |
| | Nissan Primera Traveller - R | | Kia Magentis - R |
| 341229 | Peugeot 406 - R | 341282 | Nissan Almera (N16) - R |
| 341230 | Peugeot 406 - R | | Nissan Almera (N16E) - R |
| 341231 | Peugeot 406 - R | 341283 | Nissan Almera Tino (V10) - R |
| 341232 | Toyota Land Cruiser - F | 341298 | Honda Stream - R |
| 341233 | Honda Civic, Ballade - F(R) | 341301 | Audi A6 (4B2), A6 Avant (4B5) - F |
| | Rover 45, ZS - F(R) | | Skoda Superb - F |
| 341234 | Honda Civic, Ballade - F(L) | | Volkswagen Passat - F |
| | Rover 45, ZS - F(L) | 341302 | Ford-Mercury Explorer - F |
| 341235 | Honda Prelude - F(R) | 341311 | Honda Civic - R |
| 341236 | Honda Prelude - F(L) | 341321 | Toyota Prius (Hybrid) - R |
| 341237 | Citroën Berlingo - R | 341322 | Toyota Corolla - R |
| | Peugeot Partner, Ranch - R | 341323 | Mazda Demio - R |
| 341238▼ | Citroën Jumpy / Dispatch - R | 341324 | Fiat Fiorino, Fiorino Qubo - R |
| | Fiat Scudo (220) - R | 341325 | Nissan Primera - R |
| | Peugeot Expert - R | | Nissan Primera Traveller - R |
| 341239 | Citroën Jumpy / Dispatch - R | 341330 | Honda Accord/ Vigor - F |
| | Fiat Scudo (220) - R | 341332 | Mazda Mazda 6 - F(R) |
| | Peugeot Expert - R | 341333 | Mazda Mazda 6 - F(L) |
| 341241 | Mitsubishi Galant, Sapporo (Lambda), Sigma - R | 341339 | Mercedes Benz Sprinter (901, 902, 903, 904) - R |
| 341247 | Kia Pregio - F | 341340 | Toyota Land Cruiser - F |
| 341249 | Peugeot 206 - R | 341341 | Nissan Maxima, QX - R |
| | Peugeot 206 + - R | 341344 | Toyota Land Cruiser - F |
| 341250 | Peugeot 206 - R | 341345 | Mitsubishi Space Star - R |
| | Peugeot 206 CC - R | 341348 | Mitsubishi Outlander - R |
| | Peugeot 206 SW - R | 341351 | Mazda Mazda 6 - F(R) |
| 341251 | Mitsubishi Pajero / Shogun / Montero - F | 341352 | Mazda Mazda 6 - F(L) |
| 341252 | Mazda Demio - R | 341353 | Subaru Legacy - R |
| 341253 | Mazda MX-5 - F | 341354 | Subaru Legacy - R |
| 341254 | Mazda MX-5 - R | 341355 | Isuzu D-Max - F |
| 341255 | Honda Accord/ Vigor - F | 341359 | Lexus IS200 / IS300 - F |
| 341256 | Honda Accord/ Vigor - R | 341360 | Lexus IS200 / IS300 - R |
| 341257 | Honda Accord/ Vigor - F | 341361 | Mitsubishi Outlander - R |
| 341258 | Honda Accord/ Vigor - R | 341363 | Toyota Prius (Hybrid) - R |
| 341259 | Mazda Xedos 9 - R | 341364 | Kia Sorento - F(R) |
| 341260 | Honda CR-V - F | 341365 | Kia Sorento - F(L) |
| 341261 | Honda CR-V - R | 341366 | Nissan Fair Lady, 280 ZX, 300 ZX, 350 ZX - F(R) |
| 341262 | Lexus IS200 / IS300 - F | 341367 | Nissan Fair Lady, 280 ZX, 300 ZX, 350 ZX - F(L) |
| 341263 | Lexus IS200 / IS300 - R | 341368 | Mitsubishi Lancer - R |
| 341264 | Lexus GS - F | | Mitsubishi Lancer Estate - R |
| 341265 | Lexus GS - R | 341369 | Honda Accord/ Vigor - R |
| 341266 | Lexus GS - F | 341372 | Toyota Hi-Lux - F |
| 341267 | Lexus GS - R | 341394 | Kia Sportage - F(R) |
| 341268 | Lexus LS400 - R | 341395 | Kia Sportage - F(L) |
| 341269 | Lexus LS400 - R | 341396 | Toyota Hilux VIII (_N1_) - F |
| 341271 | Nissan Maxima, QX - R | 341397 | Toyota Hi-Lux - F(R) |
| 341275 | Subaru Legacy - R | 341398 | Toyota Hi-Lux - F(L) |
| 341276 | Subaru Legacy - R | 341403 | Subaru Tribeca - R |

NUMERICAL LISTING
 NUMERISCHE LISTE
 LISTE NUMERIQUE

Numerical List

| KYB | VEHICLE FAHRZEUG VEHICULE | KYB | VEHICLE FAHRZEUG VEHICULE |
|------------|--|------------|--|
| 341425 | Mitsubishi Lancer, Lancer Sportback - R | 341712 | Ford Fiesta IV - R |
| 341427▼ | Hyundai Sonata / Sonica - R | | Ford Fiesta Van, Courier - R |
| | Hyundai XG - R | | Ford Ka, Sport Ka, Street Ka - R |
| 341444 | Mitsubishi Lancer, Lancer Sportback - R | | Mazda 121 - R |
| 341445 | Mitsubishi Pajero / Shogun / Montero - F | 341716▼ | Hyundai Santa Fe - R |
| 341449 | Mazda Mazda 6 - F(R) | | Kia Sorento - R |
| 341450 | Mazda Mazda 6 - F(L) | 341717 | Audi A4 (8D2), A4 Avant (8D5) - F |
| 341451▼ | Mazda Mazda 6 - F(R) | | Audi S4 - F |
| 341452▼ | Mazda Mazda 6 - F(L) | | Audi S5 - F |
| 341454 | Mitsubishi Outlander II - R | 341718 | Audi A5 (8T3) - F |
| | Mitsubishi Outlander III - R | | Audi A5 Cabriolet (8F7) - F |
| 341455 | Mitsubishi Lancer, Lancer Sportback - R | | Audi A5 Sportback (8TA) - F |
| 341460 | Hyundai Sonata / Sonica - F | | Audi S5 - F |
| 341461 | Nissan Pathfinder - F | 341719 | Audi A4 (8D2), A4 Avant (8D5) - F |
| | Nissan Pick-up, Cab, King Cab, Navara, NP300 - F | | Audi A5 (8T3) - F |
| 341463 | Honda CR-V - R | | Audi A5 Cabriolet (8F7) - F |
| 341487 | Subaru Impreza (GR) - R | | Audi A5 Sportback (8TA) - F |
| 341492 | Honda CR-V - R | | Audi S4 - F |
| 341603 | Jeep Cherokee - F | | Audi S5 - F |
| 341608 | Chrysler 300C - F(R) | 341720 | Audi Q5 - F |
| 341609 | Chrysler 300C - F(L) | 341727 | BMW X5 - R(R) |
| 341612 | SsangYong Actyon I - F | 341728 | BMW X5 - R(L) |
| | SsangYong Actyon Sport I (QJ) - F | 341729 | BMW X5 - R(R) |
| | SsangYong Kyron - F | | BMW X6 - R(R) |
| | SsangYong Rexton - F | 341730 | BMW X5 - R(L) |
| | SsangYong Rexton (12-) - F | | BMW X6 - R(L) |
| 341654 | Jeep Compass, Patriot - R | 341731 | Chevrolet - Daewoo Epica - R(R) |
| 341683 | Mini Mini - R | 341732 | BMW 5 Series Gran Turismo (F07) - F(R) |
| 341684 | Nissan Pick-up, Cab, King Cab, Navara, NP300 - F | 341733 | BMW 5 Series Gran Turismo (F07) - F(L) |
| 341700 | Alfa Romeo Alfa 159 - F | 341734 | BMW 5 Series Gran Turismo (F07) - R |
| | Alfa Romeo Alfa 159 Sportswagon - F | 341735 | BMW 5 Series Touring (F11) - R |
| | Alfa Romeo Alfa Brera - F | 341737 | Chevrolet - Daewoo Epica - R(L) |
| 341701 | Alfa Romeo Alfa 159 - F | 341738 | Audi A4 (8D2), A4 Avant (8D5) - F |
| | Alfa Romeo Alfa 159 Sportswagon - F | | Audi S4 - F |
| | Alfa Romeo Alfa Brera - F | 341743 | Audi A6 (4G2), A6 Avant (4G5) - F |
| | Alfa Romeo Spider - F | | Audi A7 Sportback - F |
| 341702 | Alfa Romeo Alfa 159 - R | 341744 | Audi A6 (4G2), A6 Avant (4G5) - F |
| | Alfa Romeo Alfa 159 Sportswagon - R | | Audi A7 Sportback - F |
| | Alfa Romeo Alfa Brera - R | | Audi S6 - F |
| | Alfa Romeo Spider - R | | Audi S7 Sportback - F |
| 341703 | Alfa Romeo Alfa 159 - R | 341745 | Audi A6 (4G2), A6 Avant (4G5) - F |
| | Alfa Romeo Alfa 159 Sportswagon - R | | Audi A7 Sportback - F |
| | Alfa Romeo Alfa Brera - R | | Audi S7 Sportback - F |
| 341704 | BMW 5 Series (E60) - R | 341746 | Peugeot 508, 508 SW - F |
| 341705▼ | Ford Escort Mk. V, VI, XR-3, RS - R | 341803▼ | Volkswagen Golf III Variant - R |
| | Ford Orion - R | 341813 | Renault Twingo - R |
| 341706 | BMW 5 Series (F10, F18) - F(R) | 341814 | Audi A4 (8D2), A4 Avant (8D5) - R |
| 341707 | BMW 5 Series (F10, F18) - F(L) | | Audi A4 Cabriolet (8H*) - R |
| 341708 | BMW 5 Series Touring (F11) - F(R) | 341815 | Toyota Avensis - R |
| | BMW 6 Series (F12) - F(R) | 341816 | Toyota Corolla - R |
| | BMW 6 Series (F13) - F(R) | | Toyota Corolla Verso - R |
| 341709 | BMW 5 Series Touring (F11) - F(L) | 341817 | Ford Ka, Sport Ka, Street Ka - R |
| | BMW 6 Series (F12) - F(L) | 341821 | Toyota Corolla Verso - R |
| | BMW 6 Series (F13) - F(L) | 341822 | Audi A6 (4F2), A6 Avant (4F5) - F |
| 341710 | BMW 5 Series (F10, F18) - R | 341823 | Audi A6 (4F2), A6 Avant (4F5) - F |
| 341711 | BMW 6 Series (F12) - R | 341824 | Lada 110 / 111 / 112 - R |
| | BMW 6 Series (F13) - R | | Lada Kalina - R |



| NUMERICAL LISTING NUMERISCHE LISTE LISTE NUMERIQUE | | | |
|--|--|----------------------|---|
| KYB | VEHICLE FAHRZEUG VEHICULE | KYB | VEHICLE FAHRZEUG VEHICULE |
| 341825 | Lada Priora - R | 3418006 | Audi A6 (4A2), A6 Avant (4A5), A6 Allroad (4AH) - F |
| 341826 | Lada Samara, Riva, Diva, Forma, Sagona - R | 3418007 | Audi Q5, Q5 Sportback (FY_) - F |
| 341840 | Peugeot 407, 407 SW - F | 3418008 | Audi S6 (4A*, C8) - F |
| 341841 | Peugeot 407, 407 SW - R | | Audi Q5, Q5 Sportback (FY_) - R |
| | BMW 5 Series (E39) - R | | Citroën Berlingo (K9) - R |
| | Opel Vectra B - R | | Peugeot Partner (K9) - R |
| | Vauxhall Vectra B - R | 342000 Series | |
| 341842 | Audi A4 (8D2), A4 Avant (8D5) - F | 342001 | Austin-Rover Austin, Morris - F |
| | Audi A6 (4B2), A6 Avant (4B5) - F | 342002 | Austin-Rover Austin, Morris - R |
| | Volkswagen Passat - F | 342007 | Toyota Starlet - R |
| 341843 | Audi A6 (4B2), A6 Avant (4B5) - F | 342008 | Alfa Romeo Arna - R |
| | Volkswagen Passat - F | | Nissan Cherry, Pulsar - R |
| 341844 | Audi A6 (4B2), A6 Avant (4B5) - F | | Nissan Sunny - R |
| | Skoda Superb - F | | Nissan Sunny, Sunny Traveller / Q-bic - R |
| | Volkswagen Passat - F | 342011▼ | Subaru Rex 600 - R |
| 341845 | Audi A4 (8D2), A4 Avant (8D5) - F | 342016 | Austin-Rover Austin, Morris - F |
| | Audi A4 Cabriolet (8H*) - F | | Rover 100 Series - F |
| | Seat Exeo - F | 342018 | Chevrolet - Daewoo Tico - R |
| 341846 | Volkswagen Transporter, Bus, Caravelle, Multivan - R | | Suzuki Alto - R |
| 341847 | Saab 9-5 (YS3E) - R | 342020 | Suzuki Alto - R |
| 341850 | Citroën C5 III - F | | Suzuki Wagon R+ - R |
| 341851 | Citroën C5 III - R | 342021 | Daihatsu Move - R |
| 341852 | Citroën C5 III - R | 342022 | Daihatsu Cuore / Domino - R |
| 341900▼ | Ford Escort Mk. V, VI, XR-3, RS - R | | Daihatsu Move - R |
| | Ford Orion - R | | Daihatsu Sirion / Storia - R |
| 341909 | Audi A4 (8D2), A4 Avant (8D5) - R | | Daihatsu YRV - R |
| 341910 | Alfa Romeo Alfa 166 - F | 342023 | Daihatsu Sirion / Storia - R |
| 341911 | Alfa Romeo Alfa 166 - R | | Daihatsu YRV - R |
| 341912 | Audi Cabrio (8G) - R | 342024 | Daihatsu Terios - R |
| 341916 | Ford Puma - R | 342026 | Suzuki Ignis - R |
| 341924 | Mini Mini - R | 342027 | Suzuki Ignis - R |
| 341951 | Ford Escort Mk. VII, XR-3, RS - R | 342028 | Daihatsu Cuore / Domino - R |
| 341953 | Ford Fiesta IV - R | 342031 | Suzuki Alto - R |
| | Ford Fiesta Van, Courier - R | 342032 | Daihatsu Cuore / Domino - R |
| | Ford Ka, Sport Ka, Street Ka - R | 343000 Series | |
| | Mazda 121 - R | 343003 | Ford Consul - F |
| 341964 | Renault R 21 Nevada, Société - R | | Ford Granada - F |
| 3410000 Series | | 343004 | Ford Consul - R |
| 3410047 | Honda CR-V IV (RE) - R | | Ford Granada - R |
| 3410059 | Mitsubishi Eclipse Cross (GK_) - R | 343005 | Opel Commodore - F |
| 3410078 | Mitsubishi Outlander III (GF_W, GG_W) - R | | Opel Rekord - F |
| 3410081 | Mitsubishi Outlander III (GG2W) - R | | Opel Rekord Caravan - F |
| | Hyundai Santa Fe III (DM) - R | 343006 | Opel Ascona, Manta - R |
| | Kia Sorento II (XM) - R | | Opel Commodore - R |
| 3418000 Series | | | Opel Kadett, Olympia, Aero - R |
| 3418000 | Peugeot 508, 508 SW - R | | Opel Rekord - R |
| 3418001 | BMW X5 (F15) - F | | Vauxhall Carlton, Viceroy, Omega - R |
| | BMW X6 (F16) - F | | Vauxhall Cavalier, Vectra - R |
| 3418002 | BMW X5 (F15) - R(R) | | Vauxhall Chevette - R |
| | BMW X6 (F16) - R(R) | 343008 | Saab 90 - F |
| 3418003 | BMW X5 (F15) - R(L) | | Saab 99 - F |
| | BMW X6 (F16) - R(L) | 343010 | Volvo 242, 244, 245, 264, 265, 240, 260 Series - R |
| 3418005 | Audi A4 (8W2, 8WC), A4 Avant (8W5, 8WD) - F | 343012 | Volvo P 142, P 144, P 145, P 164 - R |
| | Audi A4 Allroad (8WH, 8WJ) - F | | |
| | Audi S4 (8W2, 8WC, 8W5, 8WD) - F | | |

NUMERICAL LISTING
 NUMERISCHE LISTE
 LISTE NUMERIQUE

Numerical List

| KYB | VEHICLE FAHRZEUG VEHICULE | KYB | VEHICLE FAHRZEUG VEHICULE |
|------------|---|------------|---|
| 343017 | Fiat 124, 125, 126 - R Fiat 131 - R Seat 124, 1430 - R Seat 131 - R | 343098 | Fiat 124, 125, 126 - R Lada Niva - R Lada VAZ, Nova, Toscana - R Seat 124, 1430 - R |
| 343022 | Renault R 4 - F Renault R 5 - F | 343099 | Bedford Astra, Chevanne, Rascal Van - R Opel Astra - R Opel Kadett, Olympia, Aero - R Vauxhall Astra - R |
| 343023 | Saab 900 - F | 343121 | Mitsubishi Galant, Sapporo (Lambda), Sigma - R Mitsubishi Lancer Estate - R Nissan Sunny, Sunny Traveller / Q-bic - R Opel Ascona, Manta - R Vauxhall Cavalier, Vectra - R |
| 343024 | Saab 90 - R Saab 900 - R Saab 99 - R | 343150▼ | Renault R 9, R 11 - R Hyundai Pony, Excel - R Mitsubishi Lancer - R Suzuki Jimny / Samurai / Santana - R Toyota Dyna 150 - R Toyota Town Ace/ Model F / Space Cruiser - R |
| 343036 | Daihatsu Charmant - R Toyota Carina - R Toyota Celica - R Toyota Corolla & Sprinter - R Toyota Tercel & Corsa - R | 343152 | Renault R 9, R 11 - R |
| 343039 | Toyota Carina - R Toyota Celica - R Toyota Corona - R Toyota Corona Mk II & Cressida - R | 343153 | Hyundai Pony, Excel - R Mitsubishi Lancer - R Suzuki Jimny / Samurai / Santana - R Toyota Dyna 150 - R Toyota Town Ace/ Model F / Space Cruiser - R |
| 343042 | Toyota Carina - R Toyota Celica - R Toyota Celica Supra, Supra - R Toyota Corona - R | 343160 | GM Century, Special, Celebrity - R GM Lumina APV Mini Van, Trans Sport Mini Van - R Chrysler Le Baron, Saratoga - R |
| 343044 | Opel Senator, Monza - R Vauxhall Royale, Senator - R | 343164 | Chrysler Le Baron, Saratoga - R |
| 343047 | Chevrolet - Daewoo Espero / Aranos - R Chevrolet - Daewoo Lanos / Sens - R Chevrolet - Daewoo Nexia / Cielo - R Opel Astra - R Opel Insignia A - R Opel Insignia A Country Tourer - R Opel Insignia A Sports Tourer - R Opel Kadett, Olympia, Aero - R Opel Vectra A - R Vauxhall Astra - R Vauxhall Belmont - R Vauxhall Cavalier, Vectra - R | 343179▼ | Renault R 18 - R |
| 343048▼ | Bedford Astra, Chevanne, Rascal Van - F Opel Ascona, Manta - F Opel Kadett, Olympia, Aero - F Vauxhall Cavalier, Vectra - F Vauxhall Chevette - F | 343181▼ | Volkswagen Transporter, Bus, Caravelle, Multivan - F |
| 343053 | Volkswagen Käfer / Beetle / Coccinelle / Kever - R Volkswagen Type 181 - R | 343183 | Hyundai Pony, Excel - R Hyundai S-Coupé - R Mitsubishi Colt - Mirage - R Mitsubishi Cordia & Tredia - R Mitsubishi Lancer F - R |
| 343070▼ | Auto Bianchi Bianchina - F Fiat 124, 125, 126 - F Fiat 500, D, F, L, Nuova - F Fiat Polski 125 P, 126 P, 132 P, Polonez 1500 - F | 343184 | BMW 3 Series (E30) - R BMW 3 Series Touring (E30) - R |
| 343072 | Fiat 124, 125, 126 - F Seat 124, 1430 - F | 343185 | Suzuki Jimny / Samurai / Santana - F |
| 343083 | Saab 95, 96, GT 750 - F | 343186 | Daihatsu Taft / Rocky / Wild Cat / Four Track - F Daihatsu Taft / Rocky / Wild Cat / Four Track - R |
| 343087▼ | Volkswagen Käfer / Beetle / Coccinelle / Kever - R Volkswagen Transporter, Bus, Caravelle, Multivan - F Volkswagen Transporter, Bus, Caravelle, Multivan - R | 343187▼ | Ford Sierra - R |
| 343088▼ | Volkswagen Käfer / Beetle / Coccinelle / Kever - F | 343190 | Toyota Lite-Ace - F Toyota Town Ace/ Model F / Space Cruiser - F Seat Toledo I - R Volkswagen Corrado - R Volkswagen Golf Cabrio - R Volkswagen Golf II, Jetta II - R Volkswagen Golf III, Vento, Jetta III - R |
| 343097 | Lada Niva - F Lada VAZ, Nova, Toscana - F | 343191 | Toyota Lite-Ace - R Toyota Hi-Lux - F Volkswagen Taro - F Volkswagen Taro - F Mitsubishi L 300 / Delica - R Mitsubishi L 200 - F Mitsubishi Lancer Estate - R |
| | | 343192 | Ford Scorpio - R Ford Scorpio/ Granada (GAE/GGE) - R Volkswagen Passat, Santana - R Renault R 9, R 11 - R |
| | | 343195 | Renault R 9, R 11 - R |
| | | 343196 | Renault R 9, R 11 - R |
| | | 343198 | Mitsubishi Space Wagon, Space Van (Chariot), Expo - R |
| | | 343200▼ | |
| | | 343202▼ | |
| | | 343203▼ | |
| | | 343205 | |
| | | 343206▼ | |
| | | 343207 | |
| | | 343212 | |

NUMERICAL LISTING
 NUMERISCHE LISTE
 LISTE NUMERIQUE

|  | VEHICLE FAHRZEUG VEHICULE |  | VEHICLE FAHRZEUG VEHICULE |
|---|---|---|--|
| 343213 | Mitsubishi L 300 / Delica - R Nissan Serena - R Nissan Serena Cargo, Vanette Cargo - R Toyota Lite-Ace - R | 343254 | Toyota Dyna - F Toyota Dyna 150 - F |
| 343214 ▼ | Mazda E Series / Bongo - R Nissan Pick-up, Cab, King Cab, Navara, NP300 - R Toyota Corona - R Toyota Corona Mk II & Cressida - R | 343255 | BMW 3 Series (E36) - R |
| 343215 | Mazda E Series / Bongo - F | 343257 | Ford Escort Turnier / Clipper Mk. V, VI, VII - R |
| 343216 | Opel Omega A, Omega B - R Opel Senator , Monza - R Opel Vectra A - R Vauxhall Carlton, Viceroy, Omega - R Vauxhall Cavalier, Vectra - R Vauxhall Royale, Senator - R | 343258 | Volkswagen Corrado - R Volkswagen Golf II, Jetta II - R Volkswagen Golf III, Vento , Jetta III - R |
| 343223 | Volkswagen Passat - R | 343259 | Opel Calibra - R Vauxhall Calibra - R |
| 343226 | Mitsubishi L 300 / Delica - R | 343260 ▼ | Toyota Dyna - R Toyota Dyna 150 - R |
| 343227 | Bedford Astra, Chevanne, Rascal Van - R Opel Combo - R Opel Kadett, Olympia, Aero - R Vauxhall Combo - R | 343261 | Mitsubishi Lancer Estate - R |
| 343228 | Ford Escort Van, Express - R | 343262 ▼ | Hyundai Santamo - R Kia Joice - R Mitsubishi Santamo - R Mitsubishi Space Runner - R Mitsubishi Space Wagon, Space Van (Chariot), Expo - R |
| 343229 | Peugeot 205 - R Peugeot 309 - R | 343265 | Opel Corsa A, Corsa B - R Opel Tigra - R Vauxhall Nova, Corsa - R Vauxhall Tigra - R |
| 343231 | Alfa Romeo Alfa 33 - R Alfa Romeo Alfa Sud - R | 343266 ▼ | Renault Espace - R |
| 343233 | Renault R 19 / Chamade - R | 343267 | Toyota Lite-Ace - R |
| 343234 | Renault R 19 / Chamade - R | 343268 | BMW 3 Series Compact (E36) - R |
| 343235 | Alfa Romeo Alfa 75, 90 - F Alfa Romeo Alfetta - F | 343269 | Fiat Punto (176) - R Lancia Y - R |
| 343236 | Alfa Romeo Alfa 75, 90 - R Alfa Romeo Alfetta - R | 343270 | Saab 900 - R Saab 9-3 (YS3D) - R |
| 343238 | Daihatsu Feroza / Sportrak - R | 343271 | Audi A4 (8D2), A4 Avant (8D5) - R |
| 343239 | Mitsubishi Pajero / Shogun / Montero - R | 343272 | Toyota RAV 4 - R |
| 343240 | Nissan Sunny, Sunny Traveller / Q-bic - R | 343273 | Ford Fiesta Van, Courier - R |
| 343241 ▼ | Nissan Sunny, Sunny Traveller / Q-bic - R | 343274 | Seat Ibiza, Cordoba - R Volkswagen Golf II, Jetta II - R Volkswagen Polo, Derby - R |
| 343242 | Toyota Corolla - R | 343275 | Daihatsu Feroza / Sportrak - R |
| 343243 | Volvo 400 Series - R | 343276 | Ford Escort Turnier / Clipper Mk. V, VI, VII - R |
| 343244 ▼ | Nissan Terrano - F | 343277 | Toyota Town Ace/ Model F / Space Cruiser - F |
| 343245 ▼ | Nissan Terrano - R Toyota Hi-Lux - R | 343278 | Toyota Town Ace/ Model F / Space Cruiser - R |
| 343246 | Toyota Hi-Lux - R(R) Volkswagen Taro - R(R) | 343281 | Audi A6 (4B2), A6 Avant (4B5) - R Skoda Superb - R Volkswagen Passat - R |
| 343247 | Suzuki Grand Vitara I - R Suzuki Santana SE416 Vitara - R Suzuki Vitara - R Suzuki X-90 - R | 343282 | Toyota Picnic - R |
| 343248 | Nissan Primera Traveller - R | 343283 ▼ | Seat Ibiza, Cordoba - R |
| 343249 | Nissan Micra, March - R | 343284 | Subaru L Series - R |
| 343251 | Mitsubishi L 200 - R Toyota Hi-Lux - R | 343285 | Skoda Pick-Up, Felicia Pick-Up - R Volkswagen Golf Caddy - R |
| 343252 ▼ | Ford-Mercury Ranger - R Mazda Proceed / B Series - R Toyota Hi-Lux - R Volkswagen Taro - R | 343287 | Suzuki Jimny / Samurai / Santana - F |
| 343253 | Toyota Hi-Lux - R(L) Volkswagen Taro - R(L) | 343288 | Suzuki Jimny / Samurai / Santana - R |
| | | 343289 | Renault Clio II - R Renault Thalia, Symbol - R Renault Thalia II, Symbol II (LU1/2_) - R |
| | | 343290 | Ford Focus - R |
| | | 343291 | Ford Focus - R |
| | | 343292 | Mitsubishi L 200 - R |

NUMERICAL LISTING
 NUMERISCHE LISTE
 LISTE NUMERIQUE

Numerical List

| KYB | VEHICLE FAHRZEUG VEHICULE | KYB | VEHICLE FAHRZEUG VEHICULE |
|------------|--|------------|--|
| 343296▼ | Citroën Evasion / Synergie - R Fiat Ulysse - R Lancia Zeta - R Peugeot 806 - R | 343328 | Audi A2 (8Z0) - R Seat Ibiza V - R Seat Ibiza, Cordoba - R Skoda Fabia - R |
| 343297 | Seat Cordoba Vario - R Seat Ibiza, Cordoba - R Volkswagen Polo, Polo Variant - R | 343329 | Skoda Fabia III (NJ3, NJ5) - R Volkswagen Polo - R Fiat Punto (188) - R |
| 343298 | Skoda Octavia I Combi - R Skoda Roomster, Praktik - R Volkswagen Bora Variant - R Volkswagen Golf IV Variant - R | 343330 | Lancia Ypsilon - R BMW Z3 - R |
| 343299 | Toyota Hi-Lux - R(R) | 343331 | Opel Agila - R Subaru Justy, J Series - R |
| 343300 | Toyota Hi-Lux - R Toyota Hi-Lux - R(L) | 343332 | Suzuki Ignis - R Suzuki Wagon R+ - R Vauxhall Agila - R |
| 343302 | Audi A4 (8D2), A4 Avant (8D5) - R | 343334 | Lancia Lybra - R |
| 343304 | Chevrolet - Daewoo Matiz (UzDaewoo) - R Chevrolet - Daewoo Matiz / Spark - R | 343348 | Audi A1 (8X1), A1 Sportback (8XA) - R Audi A3 (8L1) - R |
| 343305 | Mercedes Benz V-Class (638/2) - R Mercedes Benz Vito - R | | Audi TT Roadster (8N9) - R Seat Leon I - R Seat Toledo II - R |
| 343306 | Opel Astra - R Vauxhall Astra - R | | Skoda Fabia - R Skoda Fabia III (NJ3, NJ5) - R |
| 343307 | Opel Astra - R Vauxhall Astra - R | | Skoda Octavia I - R Volkswagen Bora, Jetta IV - R |
| 343308 | Opel Combo - R Opel Meriva - R Opel Zafira I - R Vauxhall Combo - R Vauxhall Meriva - R Vauxhall Zafira I - R | | Volkswagen Golf IV - R Volkswagen New Beetle - R Volkswagen Polo - R Volkswagen Polo (9N, 9A4) - R |
| 343309 | Seat Arosa - R Volkswagen Lupo - R | 343350 | Opel Corsa C - R Vauxhall Corsa C - R |
| 343310 | Audi A3 (8L1) - R Seat Leon I - R Volkswagen Bora Variant - R Volkswagen Bora, Jetta IV - R Volkswagen Golf IV - R Volkswagen Golf IV Variant - R | 343351 | Opel Corsa C - R Vauxhall Corsa C - R |
| 343312 | Mitsubishi Space Wagon, Space Van (Chariot), Expo - R | 343352 | BMW 3 Series (E46) - R BMW 3 Series Compact (E46) - R BMW 3 Series Touring (E36) - R BMW 3 Series Touring (E46) - R |
| 343313 | Toyota RAV 4 - R | 343353 | Kia Rio - R |
| 343314 | Toyota RAV 4 - R | 343355 | Ford Maverick - R Nissan Terrano II - R |
| 343315 | Honda HR-V - R | 343381 | Honda Jazz - R |
| 343316 | Honda HR-V - R | 343385 | Chrysler PT-Cruiser - R |
| 343318 | Honda Logo - R | 343387 | Mitsubishi Space Runner - R |
| 343319 | Ford Galaxy - R Seat Alhambra - R Volkswagen Sharan - R | 343391 | Ford Transit - R |
| 343320▼ | Kia Besta - R | 343392 | Ford Transit - R |
| 343321 | Citroën C8 - R Citroën Evasion / Synergie - R Fiat Ulysse - R Lancia Phedra - R Lancia Zeta - R Peugeot 806 - R Peugeot 807 - R | 343393 | Ford Transit - R |
| 343324▼ | Ford-Mercury Ranger - F Mazda Proceed / B Series - F | 343396 | Citroën C2 - R Citroën C3 I - R |
| 343326 | Mazda Proceed / B Series - R | 343397 | Fiat Bravo II - R Fiat Stilo (192) - R Hyundai Getz - R |
| | | 343398 | Ford Transit - R |
| | | 343399 | Ford Transit - R |
| | | 343404 | Citroën C3 I - R Citroën C3 Pluriel - R Peugeot 1007 - R |
| | | 343405 | Kia Picanto - R Kia Picanto (JA) - R |
| | | 343406 | Daihatsu Materia - R |



NUMERICAL LISTING
 NUMERISCHE LISTE
 LISTE NUMERIQUE

| KYB | VEHICLE FAHRZEUG VEHICULE | KYB | VEHICLE FAHRZEUG VEHICULE |
|--------|---|--------------------------------------|--|
| 343411 | Daihatsu Sirion / Storia - R Subaru Justy - R Mitsubishi Colt - R Smart Forfour - R | 343478 343479 343482 | Chevrolet - Daewoo Matiz / Spark - R Honda Civic - R Dacia Logan MCV I - R Renault Logan MCV - R |
| 343412 | Mazda Mazda 3 - R | 343483 | Daihatsu Terios - R |
| 343413 | Ford C-Max - R Ford Focus C-Max - R Ford Focus II - R | 343484 | Mercedes Benz Sprinter II - R Volkswagen Crafter - R |
| 343414 | Mazda Mazda 3 - R Fiat Idea (135) - R Lancia Musa - R | 343485 343486 | Skoda Fabia - R Fiat Panda (169) - R Ford Ka, Sport Ka, Street Ka - R |
| 343415 | Fiat Panda (169) - R | 343488 | Fiat 500, 500 C - R |
| 343416 | Rover MGF - F | 343601▼ | Saab 9-3 (YS3F) - R |
| 343417 | Rover MGF - R | 343802 | Mitsubishi Pajero Pinin - R |
| 343418 | Dacia Logan - R Dacia Logan MCV II - R Dacia Sandero - R Renault Logan - R Renault Logan MCV II - R Renault Sandero - R | 343805 343806 343807 343808 | Toyota Yaris I - R Toyota Yaris Verso - R Nissan Micra, March - R Citroën C1 - R Citroën C1 II - R Peugeot 107 - R Peugeot 108 - R Toyota Aygo - R |
| 343419 | Volvo C 30 - R Volvo S 40, V 50 - R | 343809 | Toyota Yaris II - R Toyota Yaris III - R |
| 343420 | Opel Agila - R Suzuki Splash - R Suzuki Swift III - R Suzuki Swift IV - R Vauxhall Agila - R | 343810 343811 | Nissan Note - R Fiat Sedici - R Suzuki SX4 - R |
| 343423 | Chevrolet - Daewoo Kalos / Aveo - R | 343812 | Fiat Sedici - R Suzuki SX4 - R |
| 343424 | Kia Rio - R | 343822 | Renault Twingo - R |
| 343428 | Daihatsu Cuore / Domino - R | 343823 | Toyota Yaris III - R |
| 343431 | Toyota Yaris I - R | 343824 | Audi A1 (8X1), A1 Sportback (8XA) - R |
| 343432 | Hyundai Atos - R Hyundai Atos Prime / Amica - R | 343826 343827 | Skoda Fabia III (NJ3, NJ5) - R Lancia Delta - R Dacia Duster - R Dacia Duster (HM) - R Renault Duster - R Renault Duster (HM) - R |
| 343435 | Suzuki Grand Vitara II - R | 343828 | Fiat Punto (188) - R |
| 343436 | Mitsubishi Grandis - R | 343833 | Dacia Logan II - R Dacia Sandero II - R Dacia Sandero Stepway II - R Renault Logan II - R Renault Sandero II - R Renault Sandero Stepway II (B8_) - R Renault Thalia III, Symbol III (L8_) - R |
| 343437 | Mitsubishi Grandis - R | | Dacia Sandero Stepway II - R Renault Sandero II (B8_) - R Renault Sandero Stepway II (B8_) - R |
| 343438 | Volkswagen Fox (5Z1) - R | | Dacia Logan MCV II - R Dacia Sandero II - R Renault Logan II - R Renault Logan MCV II - R Renault Sandero II (B8_) - R |
| 343440 | Smart Cabrio - R Smart City-Coupé - R Smart Cross-blade - R Smart Fortwo Coupé, Fortwo Cabrio - R Smart Roadster - R Smart Roadster Coupé - R | | |
| 343441 | Daihatsu Terios II - R | | |
| 343459 | Alfa Romeo Mito - R Chevrolet - Daewoo Aveo - R Fiat Grande Punto (199) - R Fiat Punto (199) - R Fiat Punto Evo (199) - R Opel Corsa D - R Opel Corsa E, Corsa E Van - R Vauxhall Corsa Mk III - R Vauxhall Corsa Mk IV, Corsavan Mk IV - R | 343834 343836 | |
| 343460 | Honda Civic - R | | |
| 343464 | Suzuki Swift III - R | | |
| 343465 | Nissan Tiida - R | | |
| 343475 | Rover 75, RJ - R | | |
| | | 3430000 Series | |
| | | 3430019 | Volkswagen Beetle - R |
| | | 3430021 | Fiat Panda, Panda Van (312) - R |



Numerical List

NUMERICAL LISTING
 NUMERISCHE LISTE
 LISTE NUMERIQUE

Numerical List

| KYB | VEHICLE FAHRZEUG VEHICULE | KYB | VEHICLE FAHRZEUG VEHICULE |
|-----------------------|--|----------------------|---|
| 3430023 | Audi A3 (8V1, 8VK) - R Audi A3 Cabriolet (8V7, 8VE) - R Audi A3 Limousine (8VS, 8VM) - R Audi A3 Sportback (8VA, 8VF) - R Seat Leon III - R Seat Leon SC III - R Seat Leon ST III - R Volkswagen Golf Sportsvan (AM1) - R Volkswagen Golf VII (5G1, BE1) - R Volkswagen Golf VII Variant (BA5, BV5) - R | 3438006 | Seat Mii - R Skoda Citigo - R Volkswagen Up, Load Up - R |
| 3430029 | Hyundai i10 II - R Hyundai i10 III (AC3, AI3) - R | 3438007 | Renault Twingo - R Smart Forfour - R Smart Fortwo Coupé, Fortwo Cabrio - R |
| 3430032 | Suzuki Celerio (LF) - R | 3438008 | Renault Twingo III (BCM) - R Smart Forfour II (453) - R Smart Fortwo Coupé, Fortwo Cabrio III (453) - R |
| 3430036 | Honda Civic X (FC_, FK_) - R | 3438010 | Citroën C4 Cactus - R |
| 3430037 | Mazda CX-3 (DK) - R | 344000 Series | |
| 3430041 | Mazda Mazda 3 (BM, BN) - R | 344002 | Mercedes Benz S Series (W126) - R Mercedes Benz W Series (W114, W115) - R |
| 3430043 | Nissan Note (E12) - R | 344014 | GAZ Volga 3102, 31029, 31022, 3110 - F |
| 3430045 | Mazda Mazda 2, Demio (DL, DJ) - R | 344015▼ | Toyota Land Cruiser - R |
| 3430050 | Hyundai i20 II (GB, IB) - R | 344033▼ | Ford Transit - R |
| 3430061 | Opel Adam, Adam Rocks (M13) - R Vauxhall Adam, Adam Rocks (M13) - R | 344041 | GM S-Series - Blazer, Jimmy, Sonoma - R |
| 3430064 | Hyundai i20 Active (IB, GB) - R | 344042 | GM S-Series - Blazer, Jimmy, Sonoma - F |
| 3430069 | Opel Karl (C16) - R Vauxhall Viva (C16) - R | 344056 | Volvo 740, 745, 760 - R Volvo 740, 760 - R Volvo 780 - R Volvo 940 - R Volvo 960 - R |
| 3430072 | Hyundai Kona (OS_) - R | 344058 | Toyota Dyna 100 - F Toyota Hi-Ace - F |
| 3430074 | Seat Arona (KJ7) - R Seat Ibiza V (KJ1) - R Skoda Kamiq (NW4) - R Skoda Scala (NW1) - R Volkswagen Polo VI (AW1, BZ1) - R Volkswagen T-Cross (C11) - R | 344059 | Toyota Hi-Ace - R |
| 3430076 | Kia Rio IV (YB, SC, FB) - R | 344060 | Toyota Land Cruiser - F |
| 3430078 | Opel Corsa E (X15) - R Vauxhall Corsa Mk IV (E) (X15) - R | 344061▼ | Toyota Land Cruiser - R |
| 3430079 | Seat Arona (KJ7) - R Seat Ibiza V (KJ1) - R Skoda Kamiq (NW4) - R Skoda Scala (NW1) - R | 344062▼ | Isuzu Elf / Elf 250, 350 - F Isuzu Lite Elf / Elf 150 - F Toyota Dyna - F |
| 3438000 Series | | 344064▼ | Mitsubishi L 300 / Delica - F |
| 3438000 | Citroën C3 III (SX_, SY_) - R Citroën C-Elysée - R Peugeot 301 - R | 344065▼ | Toyota Dyna - R Toyota Hi-Ace - R |
| 3438001 | Citroën C3 Aircross II (2R_, 2C_) - R Citroën C4 Cactus - R Opel Crossland X / Crossland (P17, P2QO) - R Peugeot 2008 - R Vauxhall Crossland X (P17) - R | 344080 | Chrysler Voyager / Mini-Van, Town & Country, Caravan - R |
| 3438002 | Ford B-Max (JK) - R Ford Fiesta - R Ford Fiesta VI - R Ford Tourneo Courier (B460) - R Ford Transit Courier (B460) - R | 344081 | GM Astro, Safari Mini Van - F |
| 3438003 | Renault Fluence - R | 344082 | GM Astro, Safari Mini Van - R |
| 3438004 | Renault Wind - R | 344083▼ | Ford-Mercury Aerostar Mini Van - F |
| 3438005 | Suzuki SX4 S-Cross - R Suzuki Vitara (LY) - R | 344091 | Jeep Wrangler - F |
| | | 344092 | Jeep Wrangler - R |
| | | 344099 | Toyota Dyna 100 - R |
| | | 344100 | Toyota Hi-Ace - R |
| | | 344102 | Isuzu Lite Elf / Elf 150 - R Nissan Clipper, Caball - R Toyota Dyna - R Toyota Hi-Ace - R Toyota Lite-Ace - R Toyota Stout - R |
| | | 344105 | Daihatsu Feroza / Sportrak - F |
| | | 344111 | Mitsubishi L 300 / Delica - F |
| | | 344112 | Peugeot 205 - R |
| | | 344115 | Alfa Romeo Alfa 145/146 - R Alfa Romeo Alfa 155 - R Fiat Bravo, Brava (182) - R Fiat Coupé (175) - R Fiat Marea (185) - R |

NUMERICAL LISTING
 NUMERISCHE LISTE
 LISTE NUMERIQUE

|  | VEHICLE FAHRZEUG VEHICULE |  | VEHICLE FAHRZEUG VEHICULE |
|---|--|---|--|
| | Fiat Multipla (186) - R | 344275 | GAZ Volga 3102, 31029, 31022, 3110 - R |
| | Fiat Palio Weekend - R | 344277 | Moskwitch 2141 - R |
| | Fiat Tempra (159) - R | 344278▼ | Mazda E Series / Bongo - F |
| | Fiat Tempra Station Wagon / Familia (159) - R | 344279 | Isuzu Trooper / Big Horn - F |
| | Fiat Tipo (160) - R | | Opel Monterey - F |
| | Lancia Dedra (835) - R | | Vauxhall Monterey - F |
| | Lancia Delta - R | 344283 | Citroën Jumper / Relay - R |
| 344116 | Hyundai Galloper - R | | Fiat Ducato - R |
| | Mitsubishi Galloper - R | | Peugeot Boxer - R |
| | Mitsubishi Pajero / Shogun / Montero - R | 344284 | Citroën Jumper / Relay - R |
| 344119 | Hyundai Galloper - F | | Fiat Ducato - R |
| | Mitsubishi Galloper - F | 344285 | Hyundai H1 / Starex / Satellite / H200 - F |
| | Mitsubishi Pajero / Shogun / Montero - F | 344286 | Hyundai H1 / Starex / Satellite / H200 - R |
| 344200 | Ford Maverick - F | 344287 | Hyundai H1 / Starex / Satellite / H200 - R |
| | Nissan Terrano - F | 344288 | Toyota Land Cruiser - R |
| | Nissan Terrano II - F | 344290 | Ford-Mercury Aerostar Mini Van - R |
| 344201 | Toyota Hi-Ace - F | 344291 | Ford-Mercury Windstar Mini Van - R |
| 344202 | Toyota 4-Runner / Hilux Surf - F | 344292 | Kia Pregio - R |
| | Toyota Hi-Lux - F | 344294 | Mitsubishi Pajero Sport - F |
| | Volkswagen Taro - F | 344295 | Mitsubishi Pajero Sport - R |
| 344203 | Toyota Hi-Ace - F | 344296 | Kia Carnival / Sedona - R |
| 344204▼ | Toyota Hi-Ace - R | 344297 | Hyundai Highway Van - R |
| 344207 | Toyota Land Cruiser - F | | Hyundai Trajet - R |
| 344210▼ | Toyota Land Cruiser - F | 344298 | Opel Frontera - F |
| 344211 | Toyota Land Cruiser - F | | Vauxhall Frontera - F |
| 344212▼ | Toyota Land Cruiser - R | 344299 | Opel Frontera - R |
| 344213 | Toyota Land Cruiser - F | | Vauxhall Frontera - R |
| 344214 | Toyota Land Cruiser - R(R) | 344300 | Mitsubishi Pajero / Shogun / Montero - R |
| 344215 | Toyota Land Cruiser - R(L) | 344301 | Audi A3 (8L1) - R |
| 344216▼ | Toyota Land Cruiser - R | | Skoda Octavia I Combi - R |
| 344221▼ | Mitsubishi L 200 - F | | Volkswagen Bora Variant - R |
| 344222 | Mitsubishi Pajero / Shogun / Montero - F | | Volkswagen Bora, Jetta IV - R |
| 344223 | Mitsubishi Pajero / Shogun / Montero - R | | Volkswagen Golf IV - R |
| 344225 | Toyota Previa / Emina / Lucida - R | | Volkswagen Golf IV Variant - R |
| 344226 | Toyota Previa / Emina / Lucida - R | 344302▼ | Kia Besta - F |
| 344227 | Opel Frontera - F | 344304 | Ford-Mercury Ranger - R |
| | Vauxhall Frontera - F | | Mazda Proceed / B Series - R |
| 344228 | Opel Frontera - R | 344305 | Ford-Mercury Ranger - F |
| | Vauxhall Frontera - R | | Mazda Proceed / B Series - F |
| 344229 | Isuzu Trooper / Big Horn - R | 344306 | Nissan Interstar - F |
| | Opel Frontera - R | | Opel Movano - F |
| | Opel Monterey - R | | Renault Master II - F |
| | Vauxhall Frontera - R | | Vauxhall Movano - F |
| | Vauxhall Monterey - R | 344307 | Nissan Interstar - R |
| 344230 | Volvo 850 - R | | Opel Movano - R |
| | Volvo S 70, V 70, C 70 - R | | Renault Master II - R |
| 344254 | Toyota 4-Runner / Hilux Surf - R | | Vauxhall Movano - R |
| 344255 | Toyota Lite-Ace - F | 344308 | Toyota Previa / Emina / Lucida - R |
| 344256 | Opel Omega A Caravan, Omega B Caravan - R | 344309 | SsangYong Musso / Korando - F |
| | Vauxhall Carlton, Viceroy, Omega - R | 344310 | SsangYong Musso / Korando - R |
| 344257 | Daihatsu Taft / Rocky / Wild Cat / Four Track - F | 344314 | Hyundai Santa Fe - R |
| 344258 | Daihatsu Taft / Rocky / Wild Cat / Four Track - R | 344338 | Opel Sintra - R |
| 344261 | Volkswagen Transporter, Bus, Caravelle, Multivan - F | | Vauxhall Sintra - R |
| 344266 | GM Astro, Safari Mini Van - F | 344341 | Jeep Cherokee - F |
| 344268 | Ford-Mercury Explorer - F | 344342 | Jeep Cherokee - R |
| 344269 | Ford-Mercury Explorer - R | 344346 | Mitsubishi L 200 - F |
| 344274 | Honda Shuttle / Odyssey - R | 344352 | Mitsubishi Sigma - R |

NUMERICAL LISTING
 NUMERISCHE LISTE
 LISTE NUMERIQUE

Numerical List

| KYB | VEHICLE FAHRZEUG VEHICULE | KYB | VEHICLE FAHRZEUG VEHICULE |
|------------|--|------------|---|
| 344355 | Isuzu Trooper / Big Horn - F | 344459 | Audi A3 (8P1), A3 (8P7) - R |
| 344356 | Ford Maverick - R | | Audi A3 Sportback (8PA) - R |
| | Mazda Tribute - R | | Seat Alhambra - R |
| 344357 | Seat Toledo IV (KG3) - R | | Seat Altea, Altea XL - R |
| | Skoda Rapid - R | | Seat Leon II - R |
| | Volkswagen Polo - R | | Seat Toledo III - R |
| | Volkswagen Polo V (602, 604, 612, 614) - R | | Skoda Octavia II - R |
| 344359 | Kia Sportage - R | | Skoda Octavia II Combi - R |
| 344360 | Nissan Patrol / Safari - F | | Skoda Superb - R |
| 344362 | Toyota Avensis Verso - R | | Skoda Yeti - R |
| 344363 | Mazda Mazda 6 - R | | Volkswagen Golf Cabrio - R |
| 344389 | Mitsubishi L 200 - F | | Volkswagen Golf V - R |
| 344392 | Jeep Cherokee, Wagoneer, Grand Cherokee - F | | Volkswagen Golf V Plus - R |
| | Jeep Grand Wagoneer - F | | Volkswagen Golf V Variant - R |
| 344393 | Jeep Cherokee - F | | Volkswagen Golf VI - R |
| | Jeep Cherokee, Wagoneer, Grand Cherokee - F | | Volkswagen Golf VI Variant - R |
| | Jeep Grand Wagoneer - F | | Volkswagen Jetta V - R |
| 344394 | Jeep Cherokee - R | | Volkswagen Jetta VI - R |
| 344404 | Jeep Cherokee, Wagoneer, Grand Cherokee - R | | Volkswagen Passat - R |
| | Jeep Grand Wagoneer - R | | Volkswagen Passat CC - R |
| | Jeep Liberty - R | | Volkswagen Scirocco - R |
| 344407 | Citroën C4 - R | | Volkswagen Sharan - R |
| | Peugeot 307, 307 SW, 307 CC - R | | Volkswagen Touran - R |
| | Peugeot 308 CC - R | 344460 | Toyota Land Cruiser - R |
| 344408 | Citroën C4 II - R | 344461 | Toyota Land Cruiser - R |
| | Peugeot 307, 307 SW, 307 CC - R | 344462 | Honda Accord / Vigor - R |
| | Peugeot 308 SW I - R | 344471 | GAZ Gazel - F |
| 344409 | Mercedes Benz Sprinter (901, 902, 903, 904) - R | | GAZ Gazel - R |
| | Volkswagen Transporter LT Series - R | | GAZ Sobol - R |
| 344410 | Toyota Land Cruiser - R | 344484 | Toyota Hi-Ace - R |
| 344416 | Toyota Land Cruiser - R | 344485 | Toyota Hi-Ace - R |
| 344418 | Jeep Cherokee, Wagoneer, Grand Cherokee - R | 344486 | Ford Tourneo connect / Transit connect - R |
| | Jeep Grand Wagoneer - R | 344487 | BMW X3 - R |
| 344420 | Isuzu D-Max - F | 344488 | Mercedes Benz E-Class (211) - R |
| 344421 | Isuzu D-Max - R | 344496 | Jeep Cherokee - R |
| 344422 | Isuzu D-Max - R | 344609 | Chrysler Stratus, Cirrus, Breeze - F |
| 344439 | Nissan Murano - R | 344610 | Chrysler Stratus, Cirrus, Breeze - R |
| 344441 | GM-Avtovaz (RUS) Chevrolet Niva - F | 344611 | Honda Element - R |
| 344442 | GM-Avtovaz (RUS) Chevrolet Niva - R | 344665 | Alfa Romeo Giulietta - R |
| 344445 | Opel Astra - R | 344700 | BMW 5 Series Touring (E39) - R |
| | Vauxhall Astra - R | 344701 | BMW 5 Series Touring (E39) - R |
| 344446 | Opel Astra - R | 344702 | BMW 5 Series Touring (E61) - R |
| | Vauxhall Astra - R | 344703 | Renault Mégane III - R |
| 344451 | Kia Sorento - R | | Renault Mégane III Grandtour - R |
| 344452 | Fiat Stilo Multi Wagon (192) - R | 344704 | Renault Mégane III - R |
| 344453 | Hyundai Terracan - F | 344705 | Toyota Verso - R |
| 344454 | Hyundai Terracan - R | 344706 | Renault Scénic III, Grand Scénic III - R |
| 344455 | Nissan Fair Lady, 280 ZX, 300 ZX, 350 ZX - R | 344707 | Renault Espace V (JR_) - R |
| 344456 | Volkswagen Transporter, Bus, Caravelle, Multivan - R | | Renault Mégane IV - R |
| | Volkswagen Transporter VI, California VI (S_) - R | | Renault Scénic III, Grand Scénic III - R |
| | Volkswagen Caravelle VI, Multivan VI (S_) - R | | Renault Scénic IV, Grand Scénic IV (J9_, R9_) - R |
| 344457 | Volkswagen Caddy Life, Caddy Maxi Life - R | 344709 | Dacia Dokker, Dokker Express - R |
| 344458 | Volkswagen Caddy, Caddy Maxi - R | | Mercedes Benz Citan - R |
| | Volkswagen Caddy Life, Caddy Maxi Life - R | | Renault Dokker, Dokker Express - R |
| | Volkswagen Caddy IV (SAB, SAJ, SAA, SAH) - R | | Renault Kangoo - R |
| | Volkswagen Caddy Maxi IV (SAB, SAJ, SAA, SAH) - R | 344710 | Audi A4 (8D2), A4 Avant (8D5) - R |
| | Volkswagen Caddy Alltrack (SAB, SAA) - R | | Audi S4 - R |

NUMERICAL LISTING
 NUMERISCHE LISTE
 LISTE NUMERIQUE

| KYB | VEHICLE FAHRZEUG VEHICULE | KYB | VEHICLE FAHRZEUG VEHICULE |
|-----------------------|---|-----------------------|--|
| 344711 | Audi S5 - R Audi A4 (8D2), A4 Avant (8D5) - R Audi A5 (8T3) - R Audi A5 Cabriolet (8F7) - R Audi A5 Sportback (8TA) - R Audi A6 (4G2), A6 Avant (4G5) - R Audi A7 Sportback - R Audi S4 - R Audi S5 - R | | Opel Mokka - R Vauxhall Mokka - R |
| 344712 | Audi Q5 - R | 3440042 | Volkswagen Passat (362, 365) - R |
| 344713 | Renault Clio Grandtour - R | 3440045 | Ford Tourneo Custom (13-) - R Ford Transit (14-) - R |
| 344715 | Opel Meriva B - R Vauxhall Meriva B - R | 3440048 | Ford Transit Custom (13-) - R Opel Astra - R Opel Zafira Tourer C - R Vauxhall Astra - R Vauxhall Zafira Tourer C - R |
| 344800 | Renault Mégane II - R Renault Mégane II Grandtour - R | 3440051 | Toyota Hilux VIII (_N1_) - R |
| 344801 | Renault VelSatis - R | 3440055 | Jeep Grand Cherokee - R |
| 344802 | Renault Espace - R | 3440061 | Kia Optima (JF) - R Kia Optima Sportswagon (JF) - R |
| 344803 | Fiat Talento (296) - R Nissan NV300 (X82) - R Nissan Primastar - R Opel Vivaro - R Opel Vivaro (X82) - R Renault Trafic II - R Renault Trafic III (JG_, FG_, EG_) - R Vauxhall Vivaro - R Vauxhall Vivaro (X82) - R | 3440062 | Hyundai Tucson (TL, TLE) - R Kia Sportage IV (QL, QLE) - R |
| 344804 | Renault Scénic II, Grand Scénic II - R | 3440072 | Hyundai Grand Santa Fe - R Hyundai Santa Fe III (DM) - R Kia Sorento II (XM) - R |
| 344805 | Renault Modus - R | 3440073 | Opel Insignia B Country Tourer (Z18) - R Opel Insignia B Grand Sport (Z18) - R Opel Insignia B Sports Tourer (Z18) - R Vauxhall Insignia Mk II (Z18) - R Vauxhall Insignia Mk II Country Tourer (Z18) - R Vauxhall Insignia Mk II Sports Tourer (Z18) - R |
| 344806 | Audi A6 (4F2), A6 Avant (4F5) - R | 3440074 | Ford Transit - R |
| 344807 | Audi A4 (8D2), A4 Avant (8D5) - R Seat Exeo - R | 3440083 | Toyota Prius (_W5_) - R Toyota Prius PHV (_W52_) - R Toyota RAV 4V (_A5_, _H5_) - R |
| 344808 | Audi A4 (8D2), A4 Avant (8D5) - R Seat Exeo - R | 3440091 | Opel Astra K (B16) - R Vauxhall Astra K (B16) - R |
| 344809 | Renault Scénic I - R | 3440114 | Hyundai Kona (OS_) - R Kia Niro (DE) - R |
| 344810 | Renault Clio III - R | 3440122 | Hyundai Tucson (NX4E, NX4A) - R Hyundai Tucson (TL, TLE) - R Kia Sportage IV (QL, QLE) - R |
| 344811 | Toyota Auris - R Toyota Corolla - R Toyota Prius (Hybrid) - R | 3440125 | Ford Mondeo V (CE, CD, CF) - R |
| 344812 | Renault Kangoo - R | 3440126 | Kia Sorento III (UM) - R |
| 344813 | Renault Laguna III - R | 3448000 Series | |
| 344814 | Renault Mégane II - R Renault Mégane II Grandtour - R | 3448000 | Citroën C3 II - R Citroën DS3 - R DS DS 3 (SA_, SB_) - R |
| 344816 | Nissan Juke - R | 3448001 | Citroën C4 Picasso II, C4 Grand Picasso II - R Citroën C5 Aircross - R Opel Grandland X (A18) - R Peugeot 3008 (M_) - R Peugeot 5008 II - R Vauxhall Grandland X (A18) - R |
| 3440000 Series | | 3448002 | Renault Captur - R |
| 3440008▼ | Opel Mokka - R Vauxhall Mokka - R | 3448003 | Citroën Jumpy / Dispatch - R Fiat Scudo (270) - R Peugeot Expert , Expert Tepee - R |
| 3440013 | Mazda CX-5 (KE, GH) - R Mazda CX-5 (KF) - R | 3448004 | Renault Zoe - R |
| 3440014 | Mazda CX-5 (KF) - R | 3448005 | Dacia Lodgy - R Renault Lodgy - R |
| 3440021 | Kia Carens - R Kia Magentis - R | 3448006 | Renault Fluence - R |
| 3440028 | Hyundai Santa Fe - R Kia Sorento - R | | |
| 3440030 | Skoda Superb - R Volkswagen Beetle - R | | |
| 3440035 | Chevrolet - Daewoo Trax - R | | |

NUMERICAL LISTING
 NUMERISCHE LISTE
 LISTE NUMERIQUE

Numerical List

| | VEHICLE FAHRZEUG VEHICULE | | VEHICLE FAHRZEUG VEHICULE |
|---------|--|----------------------|--|
| 3448008 | Toyota Auris - R Toyota Auris Touring Sports (E18) - R Toyota Corolla (E18) - R | | Volkswagen Golf VII (5G1, BQ1, BE1, BE2) - R Volkswagen Golf VII Variant (BA5, BV5) - R Volkswagen Passat (3G2, CB2), Passat Variant (3G5, CB5) - R Volkswagen Passat Alltrack (3G5, CB5) - R Volkswagen Tiguan (AD1, AX1) - R Volkswagen Tiguan Allspace (BW2, BJ2) - R Volkswagen Touran (5T1) - R |
| 3448009 | Toyota Auris - R Toyota Auris Touring Sports - R | | Audi A3 (8V1, 8VK), A3 Sportback (8VA, 8VF) - R Audi A3 Limousine (8VS, 8VM) - R Audi A3 Cabriolet (8V7, 8VE) - R |
| 3448010 | Renault Kangoo - R | | Seat Leon (5F1), Leon SC (5F5), Leon ST (5F8) - R |
| 3448011 | Audi A4 (8K2), A4 Avant (8K5) - R Audi A6 (4G2) - R Audi S4 - R | 3448025 | Skoda Octavia III (5E3) - R Skoda Octavia III Combi (5E5) - R Volkswagen Golf Sportsvan (AM1, AN1) - R Volkswagen Golf VII (5G1, BQ1, BE1, BE2) - R Volkswagen Golf VII Variant (BA5, BV5) - R |
| 3448012 | Renault Clio IV - R | | Nissan Sentra (B17R) - R |
| 3448013 | Renault Clio IV - R | 3448027 | Audi Q2 (GAB, GAG) - R Seat Ateca (KH7) - R Skoda Karoq (NU7) - R |
| 3448014 | Renault Clio IV - R Renault Clio IV Grandtour - R | | Volkswagen T-Roc (A11) - R |
| 3448015 | Renault Clio IV Grandtour - R | 3448029 | Nissan Qashqai II (J11, J11_) - R Renault Kadjar (HA_, HL_) - R |
| 3448016 | Peugeot 308 II - R Peugeot 308 SW II - R | | 3448030 Renault Talisman, Talisman Grandtour (LP_, KP_) - R |
| 3448017 | BMW 1 Series (F21, F20) - R BMW 2 Series (F22) - R BMW 2 Series (F23) - R BMW 3 Series (F30) - R BMW 3 Series Gran Turismo (F34) - R BMW 3 Series Touring (F31) - R BMW 4 Series (F32) - R BMW 4 Series (F33) - R | 3448031 | Renault Mégane IV (B9A/M_) - R Renault Mégane IV Grandtour (K9A/M_) - R |
| 3448018 | BMW 4 Series Gran Coupe (F36) - R BMW 1 Series (F21, F20) - R BMW 2 Series (F22) - R BMW 2 Series (F23) - R BMW 3 Series Gran Turismo (F34) - R BMW 3 Series Touring (F31) - R BMW 4 Series (F32) - R BMW 4 Series (F33) - R BMW 4 Series Gran Coupe (F36) - R | 3448033 | Citroën C5 Aircross - R |
| 3448019 | Toyota Avenis (_T27_) - R | 3448034 | BMW 2 Series Active Tourer (F45) - R BMW 2 Series Gran Tourer (F46) - R BMW X1 (F48) - R BMW X2 (F39) - R Mini Countryman (F60) - R |
| 3448020 | Audi A4 Allroad (8KH) - R | 345000 Series | |
| 3448021 | Nissan Pulsar - R | 345005 | Land Rover Discovery - R Land Rover Land Rover - R Land Rover Range Rover - R |
| 3448023 | Audi Q2 (GAB, GAG) - R Seat Ateca (KH7) - R Skoda Karoq (NU7) - R Volkswagen Passat (3G2, CB2), Passat Variant (3G5, CB5) - R Volkswagen Passat Alltrack (3G5, CB5) - R Volkswagen T-Roc (A11) - R Volkswagen T-Roc (AC7) - R | 345006▼ | Volkswagen Transporter, Bus, Caravelle, Multivan - F |
| 3448024 | Audi A3 (8V1, 8VK), A3 Sportback (8VA, 8VF) - R Audi A3 Limousine (8VS, 8VM) - R Audi A3 Cabriolet (8V7, 8VE) - R Audi Q3 (F3B), Q3 Sportback (F3N) - R Audi S3 (8V_) - R Audi TT Coupé (FV3) - R Audi TT Roadster (FV9) - R Seat Leon (5F1), Leon SC (5F5), Leon ST (5F8) - R Seat Tarraco (KN2) - R Skoda Octavia III (5E3) - R Skoda Octavia III Combi (5E5) - R Skoda Superb III (3V3, 3V5) - R Volkswagen Arteon, Arteon Shooting Brake (3H_) - R Volkswagen Golf Sportsvan (AM1, AN1) - R | 345007 | Nissan Patrol / Safari - R |
| | | 345008 | Toyota Land Cruiser - F |
| | | 345010 | Toyota Land Cruiser - R |
| | | 345011 | Toyota Land Cruiser - R |
| | | 345014 | Land Rover Land Rover - F |
| | | 345018 | Toyota Land Cruiser - R(R) |
| | | 345019 | Toyota Land Cruiser - R(L) |
| | | 345020 | Toyota Land Cruiser - F |
| | | 345021 | Citroën Jumper / Relay - R Fiat Ducato - R Peugeot Boxer - R |
| | | 345022 | Toyota Land Cruiser - F |
| | | 345023 | Toyota Land Cruiser - R |
| | | 345024 | Mazda MPV - R |
| | | 345027 | Audi A6 (4B2), A6 Avant (4B5) - R Skoda Superb - R Volkswagen Passat - R |
| | | 345031 | Fiat Doblo, Doblo Cargo - R |
| | | 345032 | Fiat Doblo, Doblo Cargo - R |



| NUMERICAL LISTING NUMERISCHE LISTE LISTE NUMERIQUE | | | |
|--|--|----------------------|--|
| KYB | VEHICLE FAHRZEUG VEHICULE | KYB | VEHICLE FAHRZEUG VEHICULE |
| 345041 | Citroën Jumper / Relay - R Fiat Ducato - R Peugeot Boxer - R | 3458001 | Citroën Jumpy / Dispatch / Spacetourer (V_) - R Opel Vivaro C / Zafira Life (K0) - R Peugeot Expert / Traveller (V_) - R |
| 345044 | Toyota Land Cruiser - F | | Toyota Proace (MDZ_) - R |
| 345049▼ | LDV Convoy - F | | Toyota Proace Verso (MDY_) - R |
| 345050▼ | LDV Convoy - R | 3458002 | Vauxhall Vivaro C / Vivaro Life (K0) - R Alfa Romeo Mito (955) - R |
| 345056 | Nissan Pathfinder - R | | Fiat 500 L (351_, 352_) - R |
| 345065 | Peugeot 308 I - R | | Fiat Tipo (356) - R |
| 345076 | Peugeot 207 CC - R Peugeot 207 SW - R | 348000 Series | |
| 345077 | Mazda BT-50 - R | 348001 | Toyota Urban Cruiser - R |
| 345078 | Citroën Jumpy / Dispatch - R Fiat Scudo (270) - R Peugeot Expert - R | 348002 | Toyota Verso S - R |
| 345079 | Citroën Jumpy / Dispatch - R Fiat Scudo (270) - R Peugeot Expert - R | 348005 | Hyundai Accent, Pony, Excel - R |
| 345084 | Chevrolet - Daewoo Captiva - R Opel Antara - R | 348007 | Fiat Panda (169) - R |
| 345085 | Vauxhall Antara - R Citroën C4 II (B7) - R | 348008▼ | Hyundai Solaris V - R |
| 345087 | Citroën DS4 - R | | Kia Rio II - R |
| 345088 | DS DS 4 - R | | Kia Rio IV (SC, FB) - R |
| 345088 | Peugeot 3008 - R | | Kia Stonic (YB) - R |
| 345600 | Toyota Land Cruiser - R | 348016 | Dacia Sandero - R |
| 345622▼ | Fiat Palio Weekend - R | 348019 | Renault Sandero - R |
| 345700 | DS DS 4 - R | 348025 | Honda Jazz - R |
| 345701 | Peugeot 3008 - R | 348026 | Honda Civic - R |
| 345702 | Toyota Land Cruiser - R | 348027 | Alfa Romeo Mito - R |
| 345703 | Fiat Palio Weekend - R | 348028 | Daihatsu Trevis - R |
| 345704 | SsangYong Rexton - R | 348027 | Nissan Pick-up, Cab, King Cab, Navara, NP300 - R |
| | Audi Q5 - F | 348028 | Nissan Pixo - R |
| | Citroën Jumper / Relay - R | | Suzuki Alto - R |
| | Fiat Ducato - R | 348030 | Toyota Urban Cruiser - R |
| | Peugeot Boxer - R | 348031 | Citroën C3 II - R |
| | Citroën Jumper / Relay - R | | Citroën DS3 - R |
| | Fiat Ducato - R | 348032 | Chevrolet - Daewoo Cruze (J300), Cruze (J305) - R |
| | Peugeot Boxer - R | | Chevrolet - Daewoo Cruze Station Wagon (J308) - R |
| | Nissan NV400 - R | | Opel Astra - R |
| | Opel Movano (B) - R | 348034 | Vauxhall Astra - R |
| | Renault Master III - R | 348035 | Fiat Linea (323) - R |
| | Vauxhall Movano (B) - R | | Chrysler Ypsilon - R |
| | Nissan NV400 - R | | Lancia Ypsilon - R |
| | Opel Movano (B) - R | 348036 | Chevrolet - Daewoo Matiz / Spark - R |
| | Renault Master III - R | 348037 | Toyota iQ - R |
| | Vauxhall Movano (B) - R | 348053 | Kia Picanto - R |
| | Nissan NV400 - R | 348058 | Fiat Panda (312) - R |
| | Opel Movano (B) - R | 348063 | Nissan Micra, March - R |
| | Renault Master III - R | 348066 | Honda Civic - R |
| | Vauxhall Movano (B) - R | 348078 | Honda Civic - R |
| | | 348083 | Mitsubishi Mirage / Space Star VI (A0_A) - R |
| 3450000 Series | | 349000 Series | |
| 3450000 | Toyota Land Cruiser (_J15_) - R | 349007 | Saab 9-3 (YS3F) - R |
| 3450002 | Toyota Land Cruiser Prado (_J15_) - R | 349015 | Toyota Hi-Lux - R |
| 3450004 | Ford Tourneo Connect, Grand Tourneo Connect (14-) - R | 349018 | Opel Zafira II - R |
| 3450005 | Ford Transit Connect (14-) - R | 349019 | Vauxhall Zafira II - R |
| | Toyota Land Cruiser - R | | Citroën C3 Picasso - R |
| | Citroën C4 Picasso I, C4 Grand Picasso I - R | | Peugeot 207 - R |
| 3458000 Series | | | Peugeot 208 - R |
| 3458000 | Peugeot 5008 - R | 349020 | Peugeot 207 - R |

NUMERICAL LISTING
 NUMERISCHE LISTE
 LISTE NUMERIQUE

Numerical List

| KYB | VEHICLE FAHRZEUG VEHICULE | KYB | VEHICLE FAHRZEUG VEHICULE |
|------------|--|------------|---|
| 349021 | Ford Galaxy - R Ford Mondeo - R Ford S-Max - R | | Hyundai i30 Coupé - R Hyundai i30 CW - R Kia Cee'd , Pro Cee'd , Cee'd SW - R |
| 349022 | Volkswagen Eos (1F7) - R | 349085 | Hyundai Elantra - R |
| 349023 | Toyota Hi-Lux - R | 349087 | Hyundai i10 - R |
| 349024 | Lexus NX (Z1_) - R | 349090 | Mitsubishi Pajero Sport / Montero Sport - R |
| | Toyota RAV 4 - R | 349092 | Nissan Murano II (Z51) - R |
| | Toyota RAV 4 (13-) - R | 349094 | Kia Carnival / Sedona - R |
| 349038 | Hyundai Sonata / Sonica - R | 349097 | Nissan X-Trail (T31) - R |
| 349040 | Citroën C-Crosser - R | | Nissan X-Trail (T32_) - R |
| | Mitsubishi Outlander - R | 349098 | Hyundai Accent, Pony, Excel - R |
| | Peugeot 4007 - R | | Hyundai i20 - R |
| 349041 | BMW 1 Series (E81,E87) - R | | Hyundai ix20 - R |
| | BMW 1 Series (E82) - R | | Hyundai Solaris IV - R |
| | BMW 1 Series (E88) - R | | Kia Rio III - R |
| | BMW 3 Series (E90) - R | | Kia Venga - R |
| | BMW 3 Series (E92) - R | 349106 | Ford Kuga I - R |
| | BMW 3 Series (E93) - R | | Ford Kuga II - R |
| | BMW 3 Series Touring (E91) - R | 349114 | Ford Transit Tourneo - R |
| 349042 | BMW 3 Series (E90) - R | 349115 | Kia Sorento - R |
| 349044 | Mercedes Benz Sprinter II - R | 349117 | Chrysler Voyager / Mini-Van, Town & Country, Caravan - R |
| | Volkswagen Crafter - R | 349122 | Volvo S 60 II - R |
| 349045 | Mercedes Benz Sprinter II - R | | Volvo S 80 II - R |
| | Volkswagen Crafter - R | | Volvo V 60 - R |
| 349048 | Audi TT Coupé (8J3) - R | | Volvo V 70 III - R |
| | Audi TT Roadster (8J9) - R | | Volvo XC 70 II - R |
| 349050 | Mercedes Benz Sprinter II - R | 349129 | Volvo S 80 II - R |
| | Volkswagen Crafter - R | | Volvo V 70 III - R |
| 349051 | Mercedes Benz Sprinter II - R | | Volvo XC 70 II - R |
| | Volkswagen Crafter - R | 349132 | Kia Soul - R |
| 349052 | Fiat Palio, Siena (178) - R | 349136 | Opel Insignia - R |
| | Fiat Siena - R | | Vauxhall Insignia - R |
| 349055 | Mercedes Benz M-Class (W163) - F | 349137 | Skoda Octavia II - R |
| 349056 | Mercedes Benz M-Class (W163) - F | | Skoda Octavia II Combi - R |
| 349057 | Mitsubishi Pajero / Shogun / Montero - R | | Skoda Yeti - R |
| 349063 | Mazda Mazda 6 - R | | Volkswagen Beetle - R |
| 349064▼ | Mazda Mazda 6 - R | | Volkswagen Golf V - R |
| 349065 | Chrysler 300C - R | | Volkswagen Golf V Plus - R |
| 349066 | Peugeot 308 I - R | | Volkswagen Golf V Variant - R |
| 349067 | Audi Q3 - R | | Volkswagen Golf VI - R |
| | Volkswagen Tiguan - R | | Volkswagen Golf VI Variant - R |
| 349069 | Jeep Wrangler - R | | Volkswagen Jetta V - R |
| 349070 | Mazda CX-9 - R | | Volkswagen Jetta VI - R |
| 349071 | Jeep Wrangler - F | 349138 | Mercedes Benz E-Class (212) - R |
| 349076 | Mazda CX-7 - R | 349141 | Suzuki Kizashi - R |
| 349078 | Nissan Qashqai + 2 - R | 349143 | Lancia Voyager - R |
| | Nissan Qashqai II - R | 349144 | Volkswagen Amarok - R |
| | Nissan X-Trail - R | 349145 | Citroën Nemo , Nemo Combi - R |
| | Renault Kadjar (HA_, HL_) - R | | Fiat Fiorino, Fiorino Qubo - R |
| | Renault Koleos - R | | Peugeot Bipper, Bipper Tepee - R |
| 349079 | Nissan Qashqai - R | 349148 | Fiat Doblo (152) - R |
| | Nissan Qashqai + 2 - R | 349149 | Fiat Doblo Cargo (263) - R |
| 349080 | Ford Transit - R | 349155 | Citroën Berlingo - R |
| 349081 | Ford Transit - R | | Peugeot Partner Tepee/Ranch , Partner/Ranch - R |
| 349082 | Ford Transit - R | 349156 | Citroën Berlingo - R |
| 349083 | Ford Transit - R | | Citroën DS5 - R |
| 349084 | Hyundai i30 - R | | DS DS 5 - R |



| NUMERICAL LISTING NUMERISCHE LISTE LISTE NUMERIQUE | | | |
|--|--|---|---|
| | KYB VEHICLE FAHRZEUG VEHICULE | | KYB VEHICLE FAHRZEUG VEHICULE |
| 349157 | Peugeot Partner Tepee/Ranch , Partner/Ranch - R Citroën Berlingo - R | | Volkswagen Golf I, Jetta I - F Volkswagen Scirocco - F |
| 349187 | Peugeot Partner Tepee/Ranch , Partner/Ranch - R Hyundai ix35 - R Kia Sorento III (UM) - R Kia Sportage - R | 363007▼ 363012 363014 363015 363017 | Mitsubishi Lancer - F Volkswagen Käfer / Beetle / Coccinelle / Kever - F Porsche 911, 914, 924, 928, 944 - F Austin-Rover Triumph - F Fiat X 1/9 (128 AS) - F Fiat X 1/9 (128 AS) - R |
| 349189 | Hyundai ix35 - R Kia Sportage - R | | Daihatsu Charmant - F Toyota Corolla & Sprinter - F Toyota Tercel & Corsa - F |
| 349194 | Ford C-Max II - R Ford Grand C-Max - R Ford Focus III - R Volvo V40 (525, 526) - R | 363018 363037 363038 | Toyota Starlet - F Toyota Corolla & Sprinter - F Toyota MR 2 - F Toyota MR 2 - R Toyota Starlet - F Toyota Carina II - F Toyota Corolla & Sprinter - F |
| 349196 | Saab 9-5 (YS3G) - R | 363039▼ | Toyota Corolla - F |
| 349197▼ | Saab 9-5 (YS3G) - R | 363045 | Toyota Carina II - F |
| 349200 | BMW X1 - R | 363046 | Nissan Prairie - R |
| 349201 | Volkswagen Caddy, Caddy Maxi - R Volkswagen Caddy Life, Caddy Maxi Life - R Volkswagen Caddy IV (SAB, SAJ, SAA, SAH) - R | 363047 363059 | BMW 3 Series (E30) - F BMW 3 Series Touring (E30) - F |
| 349202▼ | Saab 9-5 (YS3G) - R | | 364000 Series |
| 349216 | Nissan Leaf - R | 363060 | Nissan Bluebird, Bluebird U - F |
| 349218 | Toyota Prius +, Grand Prius + - R | 363062 | Nissan Sunny Excellent - F |
| 349219 | Mazda CX-5 - R | 363065 | Nissan Violet, Stanza, Auster - F |
| 349223 | Isuzu D-Max II (TFR86J) - R | 363500 | Volkswagen Golf II, Jetta II - F BMW 3 Series (E30) - F BMW 3 Series Touring (E30) - F |
| 349227 | Volkswagen Caddy, Caddy Maxi - R Volkswagen Caddy Life, Caddy Maxi Life - R Volkswagen Caddy Maxi IV (SAB, SAJ, SAA, SAH) - R | | 365000 Series |
| 349228 | Chevrolet - Daewoo Aveo - R | 364003 | Volvo 242, 244, 245, 264, 265, 240, 260 Series - F |
| 349234 | GM Orlando - R Opel Zafira Tourer C - R Vauxhall Zafira Tourer C - R | 364014 364021 | Daihatsu Charmant - F Toyota Corolla & Sprinter - F Toyota Celica - F BMW 5 Series (E12) - F BMW 6 Series (E24) - F BMW 7 Series (E23) - F BMW Series 2.5, 2.8, 3.0, 3.3 (E3) - F |
| 349235 | Audi Q3 - R | | Opel Ascona, Manta - F Vauxhall Cavalier, Vectra - F |
| 349238 | Renault Latitude (L70_) - R | | Hyundai Pony, Excel - F |
| 349243 | Hyundai i40 - R Hyundai i40 CW - R Hyundai ix35 - R Hyundai Sonata / Sonica - R Hyundai Tucson - R Kia Optima - R Kia Sportage - R | 365006 365015 365022 365024 | Toyota Carina II - F Toyota Corolla & Sprinter - F BMW 3 Series (E21) - F BMW 5 Series (E28) - F BMW 6 Series (E24) - F Austin-Rover Triumph - F Volvo 740, 745, 760 - F Volvo 740, 760 - F Volvo 780 - F Volvo 940 - F Volvo 960 - F |
| 349244 | Hyundai Azera / Grandeur - R Hyundai ix35 - R Hyundai Tucson - R Kia Sportage - R | 365030▼ | Lada Samara, Riva, Diva, Forma, Sagona - F |
| 349246 | Mazda Mazda 6 - R | 365039 | |
| 349248 | Toyota Avensis - R | 365041 | |
| Excel-G Cartridge (36 - Series) | | | |
| 361000 Series | | | |
| 361004 | Porsche 911, 914, 924, 928, 944 - F | 365042 365043 | |
| 362000 Series | | | |
| 362001 | Nissan Sunny - F Nissan Sunny, Sunny Traveller / Q-bic - F | 365048 365053 | |
| 363000 Series | | | |
| 363001 | Volkswagen Golf Cabrio - F Volkswagen Golf Caddy - F | 365057 | |

NUMERICAL LISTING
 NUMERISCHE LISTE
 LISTE NUMERIQUE

Numerical List



| KYB | VEHICLE FAHRZEUG VEHICULE | KYB | VEHICLE FAHRZEUG VEHICULE |
|----------------------|--|---|---|
| 365058 | Toyota Carina II - F Toyota Celica - F | | Audi 200, 200 Avant - F Audi A6 (4A), A6 Avant (4A) - F Audi V8 - F |
| 365061 | Toyota Camry - F | 366005 | BMW 5 Series (E34) - F BMW 7 Series (E32) - F |
| 365062 | Toyota Camry - R | 366006 | Audi 80/90, 80 Variant/Avant [78-91] - R Audi Coupé - R |
| 365063 | Toyota Camry - R | 366007 | BMW 5 Series (E34) - F BMW 5 Series Touring (E34) - F BMW 7 Series (E32) - F |
| 365064 | Toyota Corolla - F | 366008 | Audi Coupé - R Audi S2 - R |
| 365066 | Toyota Corolla - F | 366009 | Saab 900 - F |
| 365068 | Toyota Carina II - F Toyota Celica - F | 366010 | Saab 900 - F |
| 365069 | BMW 5 Series (E34) - F | 366012 | Saab 9-3 (YS3D) - F |
| 365073 | Nissan Laurel - F | Premium Shock Absorber (44 - Series) | |
| 365076 | Toyota Celica Supra, Supra - F Toyota Corona Mk II & Cressida - F | 441000 Series | |
| 365077 | Toyota Celica - F | 441003 | BMW 3 Series (E21) - R |
| 365079 | Nissan Maxima, QX - R | 441004 | Renault R 4 - R Renault R 6 - R |
| 365081 | Toyota Carina - F | 441013 | Renault R 12, R 15, R 17 - F |
| 365082 | BMW 7 Series (E32) - F | 441018 | Volkswagen Golf Cabrio - R Volkswagen Golf I, Jetta I - R Volkswagen Scirocco - R |
| 365085 | Toyota Camry - F | 441019 | Audi 50 - R Volkswagen Polo, Derby - R |
| 365086 | Toyota MR 2 - R | 441022 | Audi 80/90, 80 Variant/Avant [78-91] - R Audi Coupé - R |
| 365091 | Toyota Corolla - F | 441023 | Citroën 2CV, Dyane, Mehari - R |
| 365092 | Toyota Celica - F | 441024 | Citroën 2CV, Dyane, Mehari - F |
| 365093 | Toyota RAV 4 - F | 441025 | Citroën 2CV, Dyane, Mehari - F |
| 365096 | Toyota Camry - F | 441026 | Citroën 2CV, Dyane, Mehari - R |
| 365097 | Toyota Camry - R | 441027 | Citroën Visa - R Peugeot 104 - R |
| 365098 | Nissan Fair Lady, 280 ZX, 300 ZX, 350 ZX - F | 441028 | Peugeot 204, 304 - R |
| 365099 | Toyota MR 2 - F | 441030 | Renault R 14 - R Renault R 5 - R |
| 365100 | Toyota MR 2 - R | 441038 | Fiat Panda (141) - R Seat Panda, Marbella - R Seat Terra, Trans - R |
| 365500 | Audi 80, 80 Variant/Avant [91-95] - F Audi 80/90, 80 Variant/Avant [78-91] - F Audi Cabrio (8G) - F Audi Coupé - F Volkswagen Passat, Santana - F | 441040 | Audi 100, 100 Avant - R Audi 200, 200 Avant - R |
| 365501 | Bedford Astra, Chevanne, Rascal Van - F Chevrolet - Daewoo Espero / Aranos - F Chevrolet - Daewoo Lanos / Sens - F Chevrolet - Daewoo Nexia / Cielo - F Opel Kadett, Olympia, Aero - F Vauxhall Astra - F Vauxhall Belmont - F | 441041 | Citroën LN, LNA - R Peugeot 104 - R Talbot Samba - R |
| 365502 | Volkswagen Passat - F | 441043 | Nissan Micra, March - R |
| 365503 | Opel Calibra - F Opel Vectra A - F Vauxhall Calibra - F Vauxhall Cavalier, Vectra - F | 441048 | Ford Sierra, XR-4, Cosworth - R |
| 365504 | Bedford Astra, Chevanne, Rascal Van - F Opel Astra - F Vauxhall Astra - F | 441053 | Mitsubishi Galant, Sapporo (Lambda), Sigma - R |
| 365505 | BMW 5 Series (E34) - F BMW 5 Series Touring (E34) - F | 441054 | Honda Civic, Ballade - R Honda Civic CR-X / Ballade CR-X - R Rover 200 Series - R |
| 365506 | Citroën AX - F Citroën Saxo - F Peugeot 106 I, 106 II - F | 441056 | Renault R 5 (Super 5) - R |
| 365507 | Lada 110 / 111 / 112 - F | 441057 | Renault R 21 - R |
| 365800 | Moskwitch 2141 - F | 441058 | Renault R 25 - F |
| 366000 Series | | 441059▼ | Suzuki Swift - R |
| 366002 | Audi 100, 100 Avant - F | | |

NUMERICAL LISTING
 NUMERISCHE LISTE
 LISTE NUMERIQUE



|  | VEHICLE FAHRZEUG VEHICULE |  | VEHICLE FAHRZEUG VEHICULE |
|---|--|---|---|
| 441061▼ | Honda Accord/Vigor - F(R) | | Peugeot Expert - R |
| 441062▼ | Honda Accord/Vigor - F(L) | 441109 | Kia Pregio - F |
| 441063 | Honda Accord/Vigor - R | 441110 | Peugeot 206 - R |
| 441064 | Renault R 5 (Super 5) Express, Rapide, Extra - R | | Peugeot 206 + - R |
| 441065 | Citroën AX - R | 441111 | Peugeot 206 - R |
| | Citroën Saxo - R | 441800 | Skoda Favorit - R |
| | Peugeot 106 I, 106 II - R | | Skoda Felicia - R |
| 441066 | Citroën Xsara Picasso - R | | Skoda Forman - R |
| | Peugeot 405 - R | | Skoda Pick-Up, Felicia Pick-Up - R |
| 441069 | Renault Espace - F | 441802 | Volkswagen Golf III Variant - R |
| 441074 | Volkswagen Golf Caddy - R | 441803▼ | Ford Escort Mk. V, VI, XR-3, RS - R |
| 441077 | Auto Bianchi Y 10 - R | | Ford Orion - R |
| | Fiat Panda (141) - R | 441824 | Lada 110 / 111 / 112 - R |
| | Lancia Y10 - R | | Lada Kalina - R |
| 441078▼ | Mitsubishi Galant, Sapporo (Lambda), Sigma - R | | Lada Priora - R |
| 441079▼ | Mitsubishi Colt - R | | Lada Samara, Riva, Diva, Forma, Sagona - R |
| | Mitsubishi Lancer - R | 441900▼ | Ford Escort Mk. V, VI, XR-3, RS - R |
| 441080▼ | Renault Espace - F | | Ford Orion - R |
| 441081 | Mercedes Benz 200, 300, 400 Series - R | 441951▼ | Ford Escort Mk. VII, XR-3, RS - R |
| | Mercedes Benz O309, O310 - R | 441960 | Peugeot 305 - R |
| | Mercedes Benz Sprinter (901, 902, 903, 904) - R | 441961 | Peugeot 305 - R |
| 441082▼ | Rover 200 Series - R | 441962 | Citroën C 15 - R |
| | Rover 400 Series - R | | Peugeot 305 - R |
| 441083 | Audi 80, 80 Variant/Avant [91-95] - R | 441963 | Peugeot 504 - R |
| 441084 | Audi 100, 100 Avant - R | 441965 | Renault Master Q Series - F |
| | Audi A6 (4A), A6 Avant (4A) - R | | Renault Master R Series - F |
| 441087 | Mitsubishi Galant, Sapporo (Lambda), Sigma - R | 441966 | Renault Master R Series - F |
| 441088 | Peugeot 605 - R | | |
| | Peugeot 607 - R | | 442000 Series |
| 441089 | BMW 5 Series (E28) - R | 442001 | Austin-Rover Austin, Morris - F |
| | BMW 6 Series (E24) - R | 442002 | Austin-Rover Austin, Morris - R |
| 441091 | Hyundai Lantra - R | 442021▼ | Suzuki Alto - R |
| 441092 | Citroën Xsara (N1/N0) - R | 442028 | Bedford Astra, Chevanne, Rascal Van - R |
| | Citroën Xsara (N2) - R | | Suzuki Carry - R |
| | Citroën ZX - R | | Suzuki Swift - R |
| | Peugeot 306 - R | 442030 | Suzuki Alto - R |
| 441093 | Citroën Xsara (N1/N0) - R | 442032 | Daihatsu Cuore / Domino - R |
| | Citroën Xsara (N2) - R | 442033 | Daihatsu Cuore / Domino - R |
| | Citroën ZX - R | 442034 | Daihatsu Cuore / Domino - R |
| | Peugeot 306 - R | 442037 | Subaru E Series, Libero - R |
| 441094 | Auto Bianchi Y 10 - R | 442038▼ | Daihatsu Cuore / Domino - R |
| | Fiat Panda (141) - R | | |
| | Lancia Y10 - R | | 443000 Series |
| 441097▼ | Rover 800 Series - F | 443004 | BMW E 10 Series - R |
| 441098 | Fiat Cinquecento (170) - R | 443005 | Auto Bianchi Bianchina - F |
| | Fiat Seicento (187) - R | | Fiat 124, 125, 126 - F |
| | Fiat Seicento Van (187) - R | | Fiat 500, D, F, L, Nuova - F |
| 441101 | Mitsubishi Canter FB Series - F | | Fiat Polski 125 P, 126 P, 132 P, Polonez 1500 - F |
| 441102 | Peugeot 406 - R | 443006 | Auto Bianchi Bianchina - R |
| 441104 | Peugeot 406 - R | | Fiat 124, 125, 126 - R |
| 441105 | Citroën Berlingo - R | | Fiat 500, D, F, L, Nuova - R |
| | Peugeot Partner, Ranch - R | | Fiat Polski 125 P, 126 P, 132 P, Polonez 1500 - R |
| 441106 | Citroën Jumpy / Dispatch - R | 443007 | Fiat 124, 125, 126 - F |
| | Fiat Scudo (220) - R | | Seat 124, 1430 - F |
| | Peugeot Expert - R | 443013 | Fiat 132 / Argenta - F |
| 441107 | Citroën Jumpy / Dispatch - R | | Fiat Polski 125 P, 126 P, 132 P, Polonez 1500 - F |
| | Fiat Scudo (220) - R | | Seat 132 - F |

NUMERICAL LISTING
 NUMERISCHE LISTE
 LISTE NUMERIQUE

Numerical List

|  | VEHICLE FAHRZEUG VEHICULE |  | VEHICLE FAHRZEUG VEHICULE |
|--|---|---|---|
| 443015 | Ford Taunus - R | 443060 | Volvo P 142, P 144, P 145, P 164 - R |
| 443016 | Ford Cortina - F Ford Taunus - F Hyundai Stellar - F | 443061 | Volvo P 142, P 144, P 145, P 164 - R |
| 443017 | Ford Cortina - R Ford Taunus - R Hyundai Stellar - R | 443062 | Volvo 242, 244, 245, 264, 265, 240, 260 Series - R |
| 443018 | Ford Consul - F Ford Granada - F | 443063 | Volvo 66 - R |
| 443020 | Ford Escort Mk. I, II - R | 443066 | Mitsubishi Galant, Sapporo (Lambda), Sigma - R Mitsubishi Lancer Estate - R Nissan Sunny, Sunny Traveller / Q-bic - R |
| 443021 | Ford Escort Mk. I, II - R | 443067 | Suzuki Jimny / Samurai / Santana - R |
| 443022 | Ford Capri - R | 443078 | Nissan Pick-up, Cab, King Cab, Navara, NP300 - F |
| 443024 | Opel Kadett, Olympia, Aero - F | 443079 | Nissan Pick-up, Cab, King Cab, Navara, NP300 - R Nissan Urvan, Caravan - R |
| 443025 | Bedford Astra, Chevanne, Rascal Van - R Opel Kadett, Olympia, Aero - R Vauxhall Chevette - R | 443080 | Nissan Pick-up, Cab, King Cab, Navara, NP300 - F |
| 443026 | Bedford Astra, Chevanne, Rascal Van - F Opel Ascona, Manta - F Opel Kadett, Olympia, Aero - F Vauxhall Cavalier, Vectra - F Vauxhall Chevette - F | 443081▼ | Mazda Familia Presto , Rotary Coupé - R Mazda Pick Up - R Mazda Proceed / B Series - R Mazda E Series / Bongo - F Mazda Pick Up - F Mazda Proceed / B Series - F |
| 443027 | Opel Ascona, Manta - R Opel Commodore - R Opel Kadett, Olympia, Aero - R Opel Rekord - R Vauxhall Carlton, Viceroy, Omega - R Vauxhall Cavalier, Vectra - R Vauxhall Chevette - R | 443098 | Toyota Carina - R Toyota Corolla & Sprinter - R |
| 443029 | Opel Commodore - F Opel Rekord - F Opel Rekord Caravan - F | 443102 | Toyota Carina - R Toyota Celica - R Toyota Corona - R Toyota Corona Mk II & Cressida - R |
| 443030 | Opel Commodore - R Opel Rekord - R Opel Rekord Caravan - R Wartburg 1000, 313, 353, Barkas - F Wartburg 1000, 313, 353, Barkas - R | 443106 | Toyota Hi-Lux - F Volkswagen Taro - F |
| 443031 | Opel Commodore - R Opel Rekord Caravan - R Vauxhall Carlton, Viceroy, Omega - R | 443114 | Alfa Romeo Giulia - F Talbot Alpine - F Talbot Simca - F |
| 443032 | Renault R 4 - F Renault R 5 - F Renault R 6 - F | 443122 | Lada Niva - F Lada VAZ, Nova, Toscana - F |
| 443033 | Saab 95, 96, GT 750 - F | 443123 | Fiat 124, 125, 126 - R Lada Niva - R Lada VAZ, Nova, Toscana - R Seat 124, 1430 - R |
| 443034 | Saab 95, 96, GT 750 - R | 443126 | Alfa Romeo Giulia - R |
| 443037▼ | Saab 900 - F | 443127 | Alfa Romeo Alfa 6 - F Alfa Romeo Alfetta - F Alfa Romeo Giulietta - F Alfa Romeo Alfetta - R Alfa Romeo Giulietta - R |
| 443045 | Volkswagen Käfer / Beetle / Coccinelle / Kever - R Volkswagen Transporter, Bus, Caravelle, Multivan - F Volkswagen Transporter, Bus, Caravelle, Multivan - R | 443130 | Talbot Horizon - R Talbot Solara - R |
| 443046 | Volkswagen Käfer / Beetle / Coccinelle / Kever - F | 443131 | Talbot Horizon - F Talbot Solara - F |
| 443047 | Volkswagen Käfer / Beetle / Coccinelle / Kever - R Volkswagen Type 181 - R | 443134 | Chevrolet - Daewoo Espero / Aranos - R Chevrolet - Daewoo Lanos / Sens - R Chevrolet - Daewoo Nexia / Cielo - R Opel Astra - R Opel Insignia A - R Opel Insignia A Country Tourer - R Opel Insignia A Sports Tourer - R Opel Kadett, Olympia, Aero - R Opel Vectra A - R Vauxhall Astra - R Vauxhall Belmont - R Vauxhall Cavalier, Vectra - R |
| 443050 | Volvo 300 Series - R | | |
| 443051 | Volkswagen Transporter, Bus, Caravelle, Multivan - F | | |
| 443054 | Volvo PV 444, PV 544, P 210 - F | | |
| 443056 | Volvo Amazon - F | | |
| 443057 | Volvo Amazon - R | | |
| 443059 | Volvo P 142, P 144, P 145, P 164 - F | | |

NUMERICAL LISTING
 NUMERISCHE LISTE
 LISTE NUMERIQUE

|  | VEHICLE FAHRZEUG VEHICULE |  | VEHICLE FAHRZEUG VEHICULE |
|---|---|---|--|
| 443135 | Bedford Astra, Chevanne, Rascal Van - R Opel Astra - R Opel Kadett, Olympia, Aero - R Vauxhall Astra - R | 443212▼ 443214 | Nissan Prairie - R Toyota Hi-Lux - F Volkswagen Taro - F |
| 443144 | Skoda 1000, 100, 110, 105, 120 - R | 443215 | Mazda E Series / Bongo - F |
| 443145 | Wartburg 1000, 313, 353, Barkas - F | 443216 | Ford-Mercury Ranger - F Isuzu Pick-up / Faster / Campo / Brava - F Mazda Proceed / B Series - F |
| 443149 | Mitsubishi L 300 / Delica - R Nissan Serena - R Nissan Serena Cargo, Vanette Cargo - R Toyota Lite-Ace - R | 443217 | Opel Campo/ Brava - F Vauxhall Campo/ Brava - F Toyota Hi-Lux - R Volkswagen Taro - R |
| 443150 | Daihatsu Taft / Rocky / Wild Cat / Four Track - R Mitsubishi L 300 / Delica - R Toyota Blizzard - R Toyota Lite-Ace - R | 443220 | Peugeot 205 - R Peugeot 309 - R |
| 443152 | Daihatsu Taft / Rocky / Wild Cat / Four Track - F Toyota Blizzard - F | 443222 | Mitsubishi Lancer Estate - R |
| 443156 | Suzuki Jimny / Samurai / Santana - F | 443223 | Mitsubishi L 300 / Delica - R |
| 443164 | Volkswagen Passat, Santana - R | 443224 | Mitsubishi L 300 / Delica - R |
| 443170 | Mercedes Benz 200, 300, 400 Series - F Mercedes Benz O309, O310 - F | 443225 | Opel Corsa A, Corsa B - R Vauxhall Nova, Corsa - R |
| 443172▼ | Volkswagen Golf Cabrio - R Volkswagen Golf I, Jetta I - R Volkswagen Scirocco - R | 443226 | Nissan Pick-up, Cab, King Cab, Navara, NP300 - R |
| 443177 | Daihatsu Taft / Rocky / Wild Cat / Four Track - F Nissan Vanette, Vanette Cargo - R | 443227▼ | Nissan Pick-up, Cab, King Cab, Navara, NP300 - F |
| 443179 | Mazda E Series / Bongo - R Nissan Pick-up, Cab, King Cab, Navara, NP300 - R Toyota Corona - R Toyota Corona Mk II & Cressida - R | 443229 | Nissan Sunny, Sunny Traveller / Q-bic - R |
| 443181 | Toyota Lite-Ace - F | 443230 | Opel Ascona, Manta - R Vauxhall Cavalier, Vectra - R |
| 443183 | Nissan Terrano - R Toyota Hi-Lux - R | 443233 | Bedford Astra, Chevanne, Rascal Van - R Opel Combo - R Opel Kadett, Olympia, Aero - R Vauxhall Combo - R |
| 443184 | Nissan Vanette, Vanette Cargo - R | 443234 | Opel Omega A, Omega B - R Opel Senator, Monza - R Opel Vectra A - R Vauxhall Carlton, Viceroy, Omega - R Vauxhall Cavalier, Vectra - R Vauxhall Royale, Senator - R |
| 443186 | Bedford KB series - R Isuzu Pick-up / Faster / Campo / Brava - R Isuzu Trooper / Big Horn - R | 443235▼ | Volkswagen Golf II, Jetta II - R |
| 443187 | Nissan Vanette, Vanette Cargo - F | 443236▼ | Volkswagen Golf II, Jetta II - R |
| 443188 | Bedford KB series - F Isuzu Pick-up / Faster / Campo / Brava - F Isuzu Trooper / Big Horn - F | 443237▼ | Peugeot J7 - R Peugeot J9 - R |
| 443189 | Mitsubishi L 200 - F | 443238 | Nissan Pick-up, Cab, King Cab, Navara, NP300 - F |
| 443190 | Bedford KB series - F Isuzu Pick-up / Faster / Campo / Brava - F Opel Campo/ Brava - F Vauxhall Campo/ Brava - F | 443239 | Nissan Pick-up, Cab, King Cab, Navara, NP300 - F |
| 443194 | Hyundai Pony, Excel - R Mitsubishi Lancer - R Suzuki Jimny / Samurai / Santana - R Toyota Dyna 150 - R Toyota Town Ace/ Model F / Space Cruiser - R | 443240 | Nissan Pick-up, Cab, King Cab, Navara, NP300 - R |
| 443198 | Mitsubishi Pajero / Shogun / Montero - R | 443241▼ | Toyota Hi-Lux - R |
| 443204 | Fiat Polski 125 P, 126 P, 132 P, Polonez 1500 - R | 443243 | Ford Transit - F |
| 443205▼ | Renault R 18 - R | 443246 | Volkswagen Passat - R |
| 443207 | BMW 3 Series (E30) - R | 443248 | Alfa Romeo Alfa 75, 90 - F Alfa Romeo Alfetta - F |
| 443208 | Ford Sierra - R | 443249 | Alfa Romeo Alfa 75, 90 - R Alfa Romeo Alfetta - R |
| 443209 | Volkswagen Passat, Santana - R | 443250 | Mitsubishi Colt - R Mitsubishi Lancer - R Proton Saga, Proton, Proton MPi - R Mitsubishi Lancer Estate - R |
| | | 443251▼ | Volvo 400 Series - R |
| | | 443252 | Toyota Hi-Lux - R(R) |
| | | 443254 | Volkswagen Taro - R(R) |
| | | 443255 | Nissan Micra, March - R |
| | | 443257 | Toyota Hi-Lux - R(L) Volkswagen Taro - R(L) |

NUMERICAL LISTING
 NUMERISCHE LISTE
 LISTE NUMERIQUE

Numerical List

| KYB | VEHICLE FAHRZEUG VEHICULE | KYB | VEHICLE FAHRZEUG VEHICULE |
|------------|--|----------------------|---|
| 443258 | Mitsubishi L 200 - R Toyota Hi-Lux - R | 443303 | Citroën C8 - R Citroën Evasion / Synergie - R |
| 443259 | Ford-Mercury Ranger - R Mazda Proceed / B Series - R Toyota Hi-Lux - R Volkswagen Taro - R | | Fiat Ulysse - R Lancia Phedra - R Lancia Zeta - R Peugeot 806 - R Peugeot 807 - R |
| 443260 | Toyota Dyna - F Toyota Dyna 150 - F | 443307 | Daihatsu Hijet - R Piaggio Porter - R |
| 443262 | Toyota Dyna - R Toyota Dyna 150 - R | 443342 | Isuzu Pick-up / Faster / Campo / Brava - F |
| 443263 | Mitsubishi Lancer Estate - R | 443363 | Nissan Pathfinder - R |
| 443265 | Hyundai Santamo - R Kia Joice - R Mitsubishi Santamo - R Mitsubishi Space Runner - R Mitsubishi Space Wagon, Space Van (Chariot), Expo - R | 443398 | Renault Thalia, Symbol - R Renault Thalia II, Symbol II (LU1/2_) - R |
| 443269 | Hyundai Pony, Excel - R Hyundai S-Coupé - R | 443399 | Chevrolet - Daewoo Kalos / Aveo - R |
| 443270 | Renault Espace - R | 443401 | Piaggio Porter - R |
| 443271 | Fiat Uno (146) - R | 443402 | Piaggio Porter - R |
| 443272 | Mercedes Benz MB Series - F | 443466 | Nissan Homer, Cabstar - R Renault Maxity - R |
| 443273 | Mercedes Benz MB Series - F | 443467 | Nissan Homer, Cabstar - R Renault Maxity - R |
| 443277 | Citroën Evasion / Synergie - R Fiat Ulysse - R Lancia Zeta - R Peugeot 806 - R | 443800 | Seat Toledo I - R Volkswagen Golf Cabrio - R Volkswagen Golf II, Jetta II - R Volkswagen Golf III, Vento , Jetta III - R |
| 443278 | Ford Escort Van, Express - R | 443801 | Seat Ibiza, Cordoba - R Volkswagen Polo, Derby - R |
| 443279 | Nissan Vanette, Vanette Cargo - R | 444000 Series | |
| 443280 | Toyota Dyna 150 - F | 444002▼ | Volkswagen Transporter, Bus, Caravelle, Multivan - R |
| 443283 | Mitsubishi Space Gear, L 400 - R | 444012 | Toyota Land Cruiser - R |
| 443284 | Mitsubishi Space Gear, L 400 - R | 444022 | Mitsubishi Delica, T Series - F Mitsubishi L 300 / Delica - F Toyota Hi-Ace - F |
| 443285 | Mazda E Series / Bongo - R Mitsubishi Space Gear, L 400 - R Nissan Bluebird, Bluebird U - R Toyota Dyna 150 - R | 444023 | Hyundai H 100 - R Isuzu Lite Elf / Elf 150 - R Nissan Clipper, Caball - R Toyota Dyna - R Toyota Hi-Ace - R Toyota Stout - R |
| 443286 | Mitsubishi Space Gear, L 400 - R | 444024 | Nissan Clipper, Caball - R Toyota Coaster - F Toyota Dyna - F Toyota Land Cruiser - F |
| 443287 | Seat Inca - R Volkswagen Polo Caddy - R | 444025 | Bedford Fargo / Midi / Seta - R Isuzu Fargo / Midi / Seta - R Isuzu Pick-up / Faster / Campo / Brava - R Mazda T Series - R Nissan Homer, Cabstar - R Nissan Urvan, Caravan - R Toyota Coaster - R Toyota Dyna - R |
| 443290 | Mitsubishi L 200 - R | 444026 | Nissan Homer, Cabstar - R Nissan Junior - R Toyota Hi-Lux - R Toyota Land Cruiser - R Toyota Stout - R |
| 443291 | Skoda Pick-Up, Felicia Pick-Up - R Volkswagen Golf Caddy - R | 444027▼ | Toyota Land Cruiser - F |
| 443292 | Mitsubishi L 200 - R | | |
| 443293 | Nissan Pick-up, Cab, King Cab, Navara, NP300 - F | | |
| 443294 | Nissan Pathfinder - R | | |
| 443295 | Ford Maverick - R Isuzu Pick-up / Faster / Campo / Brava - R Nissan Terrano II - R Opel Campo/ Brava - R Vauxhall Campo/ Brava - R | | |
| 443296 | Seat Cordoba Vario - R Seat Ibiza, Cordoba - R Volkswagen Polo, Polo Variant - R | | |
| 443297▼ | Toyota Hi-Lux - R | | |
| 443298 | Toyota Hi-Lux - R | | |
| 443301 | Chevrolet - Daewoo Matiz (UzDaewoo) - R Chevrolet - Daewoo Matiz / Spark - R | | |
| 443302 | Kia Besta - R | | |

NUMERICAL LISTING
 NUMERISCHE LISTE
 LISTE NUMERIQUE

| KYB | VEHICLE FAHRZEUG VEHICULE | KYB | VEHICLE FAHRZEUG VEHICULE |
|------------|--|------------|--|
| 444028 | Isuzu Elf / Elf 250, 350 - F Isuzu Lite Elf / Elf 150 - F Toyota Dyna - F | 444102 | Fiat Tipo (160) - R Ford Maverick - F Nissan Terrano - F |
| 444029 | Ford Transit - F | | Nissan Terrano II - F |
| 444030 | Ford Transit - R | 444103 | Toyota Hi-Lux - F Volkswagen Taro - F |
| 444031 | Renault R 12, R 15, R 17 - R | 444104 | Toyota Hi-Ace - F |
| 444036 | Peugeot 504 - R Peugeot 505 - R Peugeot 604 - R Talbot Tagora - R | 444105 | Toyota Hi-Ace - R |
| 444037 | Peugeot 504 - R | 444106▼ | Toyota Land Cruiser - F |
| 444039 | Nissan Urvan, Caravan - F | 444107 | Toyota Land Cruiser - R |
| 444040 | Bedford Fargo / Midi / Seta - R Isuzu Fargo / Midi / Seta - R Toyota Coaster - F | 444109 | Mitsubishi Canter FC Series - R Mitsubishi Canter FE Series - R |
| 444042 | Land Rover Land Rover - F | 444110 | Toyota Land Cruiser - F |
| 444043 | Land Rover Land Rover - R | 444112 | Toyota Land Cruiser - R |
| 444044 | Land Rover Land Rover - R | 444113 | Toyota Land Cruiser - F |
| 444050 | Volkswagen Transporter LT Series - F | 444114▼ | Toyota Land Cruiser - F |
| 444051▼ | Volkswagen Transporter LT Series - R | 444115 | Toyota Land Cruiser - R(R) |
| 444052 | Nissan Patrol / Safari - F | 444116 | Toyota Land Cruiser - R(L) |
| 444053 | Nissan Patrol / Safari - R | 444117 | Mitsubishi L 200 - F |
| 444054 | Nissan Homer, Cabstar - F | 444118 | Nissan Vanette, Vanette Cargo - F |
| 444055 | Nissan Homer, Cabstar - R | 444119 | Volkswagen Transporter, Bus, Caravelle, Multivan - F |
| 444056 | Isuzu Elf / Elf 250, 350 - R Isuzu Lite Elf / Elf 150 - R | 444120 | Opel Frontera - F Vauxhall Frontera - F |
| 444057 | Isuzu Elf / Elf 250, 350 - R | 444122 | Opel Frontera - R Vauxhall Frontera - R |
| 444058 | Isuzu Elf / Elf 250, 350 - R | 444123 | Toyota Hi-Ace - R |
| 444060 | Nissan Clipper, Caball - F | 444124 | Ford Transit - R |
| 444061 | Daihatsu Delta (Truck) - R | 444125 | Ford Transit - R |
| 444064 | Daihatsu Delta (Truck) - F | 444126 | Mercedes Benz MB Series - R |
| 444065 | Bedford Fargo / Midi / Seta - F Isuzu Fargo / Midi / Seta - F | 444127▼ | Mercedes Benz MB Series - R |
| 444067 | Mitsubishi Pajero / Shogun / Montero - F | 444128 | Hyundai H 100 - F |
| 444068 | Mitsubishi L 300 / Delica - F | 444129 | Nissan Patrol / Safari - F |
| 444077 | Peugeot 404 - R | 444130 | Nissan Patrol / Safari - R |
| 444078 | Toyota Land Cruiser - F | 444131 | Nissan Serena - R |
| 444082 | Volvo 740, 745, 760 - R Volvo 740, 760 - R Volvo 780 - R Volvo 940 - R Volvo 960 - R | 444132 | Isuzu Trooper / Big Horn - F Nissan Urvan, Caravan - F |
| 444083 | Isuzu Trooper / Big Horn - R | 444134 | Ford Sierra - R |
| 444084 | Toyota Dyna - F Toyota Dyna - R Toyota Hi-Ace - R | 444135 | Ford-Mercury Ranger - F Mazda Proceed / B Series - F |
| 444085 | Toyota Dyna 100 - F Toyota Hi-Ace - F | 444136 | Ford-Mercury Ranger - R Mazda Proceed / B Series - R |
| 444088 | Peugeot 505 - R | 444137 | Mitsubishi L 300 / Delica - F Mitsubishi Space Gear, L 400 - F |
| 444089 | Mitsubishi L 300 / Delica - F | 444138 | Mitsubishi Space Gear, L 400 - F |
| 444090▼ | Mitsubishi L 300 / Delica - F | 444139 | Mitsubishi Pajero / Shogun / Montero - F |
| 444091 | Peugeot 205 - R | 444144 | Mazda E Series / Bongo - F |
| 444092 | Toyota Land Cruiser - R | 444145 | Mercedes Benz 500, 600, 700, 800 Series - F Mercedes Benz O609, O611, O614 - F |
| 444093▼ | Toyota Hi-Ace - F | 444146 | Mercedes Benz 200, 300, 400 Series - F Mercedes Benz 200, 300, 400 Series - R |
| 444094 | Ford Transit - R | | Mercedes Benz 500, 600, 700, 800 Series - F Mercedes Benz 500, 600, 700, 800 Series - R |
| 444096 | Volkswagen Transporter LT Series - R | | Mercedes Benz O309, O310 - F Mercedes Benz O309, O310 - R |
| 444100▼ | Fiat Tempra (159) - R | 444147▼ | Mercedes Benz 200, 300, 400 Series - F Mercedes Benz 200, 300, 400 Series - R |

NUMERICAL LISTING
 NUMERISCHE LISTE
 LISTE NUMERIQUE

Numerical List

| KYB | VEHICLE FAHRZEUG VEHICULE | KYB | VEHICLE FAHRZEUG VEHICULE |
|----------------------|--|---------------------------------|--|
| 444148 | Mitsubishi Canter FB Series - F | | Mercedes Benz G-Class [9.93-] - F |
| | Mitsubishi Canter FE Series - F | 445033 | Mercedes Benz G-Class [-8.93] - R |
| 444149 | Mitsubishi Canter FB Series - F | | Mercedes Benz G-Class [9.93-] - R |
| | Mitsubishi Canter FC Series - F | 445034 | Mercedes Benz G-Class [-8.93] - R |
| | Mitsubishi Canter FE Series - F | | Mercedes Benz G-Class [9.93-] - R |
| | Mitsubishi Canter FH Series - F | 445035 | Land Rover Discovery - F |
| 444150 | Mitsubishi L 200 - F | 445036 | Land Rover Discovery - R |
| 444154 | Mercedes Benz 200, 300, 400 Series - F | 445037 | Land Rover Discovery - F |
| | Mercedes Benz 200, 300, 400 Series - R | | Land Rover Range Rover - F |
| | Mercedes Benz 500, 600, 700, 800 Series - F | 445038▼ | Land Rover Range Rover - F |
| | Mercedes Benz 500, 600, 700, 800 Series - R | 445042 | Land Rover Range Rover II - F |
| | Mercedes Benz O309, O310 - F | 445043 | Land Rover Range Rover II - R |
| | Mercedes Benz O309, O310 - R | 445080 | LDV Convoy - F |
| 444155 | Renault Trafic T Series - R | 445081 | LDV Convoy - R |
| 444156 | Renault Trafic T Series - R | 445092 | Citroën C 25 - R |
| 444157 | Mitsubishi Canter FB Series - R | | Fiat Ducato - R |
| | Mitsubishi Canter FE Series - R | | Fiat Talento (290) - R |
| 444158▼ | Nissan Serena - R | | Peugeot J5 - R |
| 444159 | Nissan Patrol / Safari - F | Gas-A-Just (55 - Series) | |
| 444160 | Nissan Patrol / Safari - R | | |
| 444161 | Volkswagen Transporter LT Series - R | 551000 Series | |
| 444162 | Kia Besta - F | | |
| 444262 | Mercedes Benz Sprinter (901, 902, 903, 904) - R | 551004 | Porsche 911, 914, 924, 928, 944 - R |
| | Volkswagen Transporter LT Series - R | 551016 | Mercedes Benz S Series (W108, W109) - F |
| 444266 | Chevrolet Chevrolet Niva - F | | Mercedes Benz W Series (W110, W111) - F |
| 444267▼ | Chevrolet Chevrolet Niva - R | | Mercedes Benz W Series (W113) - F |
| 444300 | Iveco Daily - F | 551017 | Mercedes Benz S Series (W126) - F |
| 444302 | Iveco Daily - F | | Mercedes Benz SL Series (W107)/(R107)/(C107) - F |
| 444303 | Iveco Daily - F | | Mercedes Benz W Series (W114, W115) - F |
| 444305 | Iveco Daily - R | 551018 | Mercedes Benz S Series (W116) - F |
| 444306 | Iveco Daily - R | | Mercedes Benz S Series (W126) - F |
| 444322 | Nissan Homer, Cabstar - F | | Mercedes Benz W Series (W123, C123, S123) - F |
| | Renault Maxity - F | 551022 | Jaguar XJ Type - R |
| 445000 Series | | 551029 | Renault R 4 - R |
| 445007 | Land Rover Land Rover - R | 551045▼ | Renault R 4 - R |
| 445010 | Bedford CF series - F | 551049▼ | Volkswagen Transporter, Bus, Caravelle, Multivan - F |
| | Opel Blitz (Bedford CF) - F | 551050▼ | Toyota Starlet - R |
| 445011 | Bedford CF series - R | 551053▼ | Citroën Xsara Picasso - R |
| | Opel Blitz (Bedford CF) - R | | Peugeot 405 - R |
| 445016 | Isuzu Elf / Elf 250, 350 - F | 551054▼ | Renault Clio I - R |
| 445019 | Volkswagen Transporter, Bus, Caravelle, Multivan - F | 551057 | Jaguar XJ Type (XJ 40, XJ 81 Series) - R |
| 445020 | Volkswagen Transporter, Bus, Caravelle, Multivan - R | 551063 | Volkswagen Passat - R |
| 445021 | Peugeot 404 - R | | Volkswagen Passat, Santana - R |
| | Peugeot 504 - R | 551064▼ | Toyota Paseo - R |
| 445022 | Citroën C 25 - R | | Toyota Starlet - R |
| | Fiat Ducato - R | 551068 | Renault Clio I - R |
| | Peugeot J5 - R | 551069 | Toyota Celica Supra, Supra - F |
| 445025 | Land Rover Range Rover - R | 551070 | Toyota Celica Supra, Supra - R |
| 445026 | Land Rover Land Rover - F | 551071 | Renault Master Q Series - R |
| 445028 | Mazda MPV - R | | Renault Master R Series - R |
| 445029 | Mercedes Benz G-Class [-8.93] - F | 551077 | Renault R 5 (Super 5) Express, Rapide, Extra - R |
| 445030 | Mercedes Benz G-Class [-8.93] - F | 551090▼ | Ford-Mercury Explorer - F |
| | Mercedes Benz G-Class [9.93-] - F | 551105 | Mazda Mazda 5 - R |
| | Mercedes Benz G-Class [-8.93] - R | 551106 | Lexus GS - F(R) |
| 445031 | Mercedes Benz G-Class [9.93-] - F | 551107 | Lexus GS - F(L) |
| | Mercedes Benz G-Class [-8.93] - F | 551108 | Lexus GS - R |
| 445032 | Mercedes Benz G-Class [-8.93] - F | | |





NUMERICAL LISTING
 NUMERISCHE LISTE
 LISTE NUMERIQUE

| KYB | VEHICLE FAHRZEUG VEHICULE | KYB | VEHICLE FAHRZEUG VEHICULE |
|-----------------------|---|------------|---|
| 551115 | Mazda RX-8 - F | | Lada Niva - R |
| 551116 | Mazda RX-8 - R | | Lada VAZ, Nova, Toscana - R |
| 551117 | Mazda MX-5 - F | | Seat 124, 1430 - R |
| 551118 | Mazda MX-5 - R | 553013 | Porsche 911, 914, 924, 928, 944 - R |
| 551122 | Lexus LS460 - F | 553020 | Volvo Amazon - F |
| 551123 | Lexus LS460 - R(R) | 553021 | Volvo Amazon - R |
| 551124 | Lexus LS460 - R(L) | 553039 | Mazda Familia Presto , Rotary Coupé - R |
| 551126 | Lexus IS II - F(R) | | Mazda Pick Up - R |
| 551127 | Lexus IS II - F(L) | 553055 | Toyota Corolla & Sprinter - R |
| 551130 | Lexus IS II - F(R) | | Toyota Corona - R |
| | Lexus IS III (_E3_) - F(R) | 553057 | Toyota Corona - F |
| 551131 | Lexus IS II - F(L) | | Toyota Corona Mk II & Cressida - F |
| | Lexus IS III (_E3_) - F(L) | | Toyota Hi-Lux - F |
| 551132 | Lexus IS II - R | | Toyota Stout - F |
| 551611 | Jaguar S-Type - F | 553060 | Toyota Corona Mk II & Cressida - R |
| 551612 | Jaguar S-Type - R | | Toyota Hi-Lux - R |
| 551804 | Renault Mégane I, Mégane Classic - R | | Toyota Stout - R |
| 551805 | Renault Laguna I - R | 553074 | Jaguar XJ Type - F |
| 551807 | Renault Scénic I - R | 553075▼ | Chevrolet - Daewoo Espero / Aranos - R |
| | Renault Scénic I (96-03) - R | | Chevrolet - Daewoo Lanos / Sens - R |
| 551808 | Renault Laguna I - R | | Chevrolet - Daewoo Nexia / Cielo - R |
| 551810 | Nissan Kubistar - R | | Opel Astra - R |
| | Renault Kangoo - R | | Opel Insignia A - R |
| 551811 | Nissan Kubistar - R | | Opel Insignia A Country Tourer - R |
| | Renault Kangoo - R | | Opel Insignia A Sports Tourer - R |
| 551819 | Renault Mégane I, Mégane Coach - R | | Opel Kadett, Olympia, Aero - R |
| 551820 | Renault Mégane I, Mégane Classic - R | | Opel Vectra A - R |
| | Renault Mégane I, Mégane Coach - R | | Vauxhall Astra - R |
| 551922 | Volvo S 90, V 90 - R | | Vauxhall Belmont - R |
| 551923▼ | Volvo S 90, V 90 - R | | Vauxhall Cavalier, Vectra - R |
| 551926 | Mercedes Benz E-Class (211) - F | 553083 | Mitsubishi Galant, Sapporo (Lambda), Sigma - R |
| 5510000 Series | | | Nissan Sunny, Sunny Traveller / Q-bic - R |
| 5510017 | Toyota Land Cruiser (_J15_) - F | 553084 | Nissan Clipper, Caball - R |
| | Toyota Land Cruiser Prado (_J15_) - F | | Toyota Hi-Ace - R |
| 552000 Series | | | Toyota Lite-Ace - R |
| 552001 | Nissan Cherry, Pulsar - R | 553085 | Mazda E Series / Bongo - F |
| 552006 | Toyota Starlet - R | | Mazda Pick Up - F |
| 552010▼ | Nissan Cherry, Pulsar - R | 553086▼ | Mazda Proceed / B Series - F |
| | Nissan Sunny - R | 553087 | Mazda Proceed / B Series - F |
| | Nissan Sunny, Sunny Traveller / Q-bic - R | | Bedford KB series - F |
| 552016 | Austin-Rover Triumph - R | | Isuzu Pick-up / Faster / Campo / Brava - F |
| 552018 | Austin-Rover Austin, Morris - F | | Isuzu Trooper / Big Horn - F |
| 552019 | Austin-Rover Austin, Morris - R | 553088 | Nissan Pick-up, Cab, King Cab, Navara, NP300 - F |
| 552022▼ | Isuzu Gemini - R | 553096 | Daihatsu Taft / Rocky / Wild Cat / Four Track - R |
| 552700 | Audi A2 (8Z0) - R | | Nissan Pick-up, Cab, King Cab, Navara, NP300 - R |
| | Seat Ibiza V - R | 553099▼ | Nissan Vanette, Vanette Cargo - F |
| | Seat Ibiza, Cordoba - R | 553100 | Nissan Vanette, Vanette Cargo - R |
| | Skoda Fabia - R | 553106▼ | Mitsubishi Delica, T Series - R |
| | Skoda Fabia III (NJ3, NJ5) - R | | Suzuki Jimny / Samurai / Santana - R |
| | Volkswagen Polo - R | 553107▼ | Toyota Town Ace/ Model F / Space Cruiser - R |
| 5528000 Series | | 553108 | Suzuki Jimny / Samurai / Santana - F |
| 5528000 | Nissan Micra V (K14) - R | | Bedford KB series - R |
| 553000 Series | | | Isuzu Pick-up / Faster / Campo / Brava - R |
| 553005▼ | Fiat 124, 125, 126 - R | 553110▼ | Isuzu Trooper / Big Horn - R |
| | | | Toyota Hi-Lux - F |
| | | | Volkswagen Taro - F |



Numerical List

NUMERICAL LISTING
 NUMERISCHE LISTE
 LISTE NUMERIQUE

Numerical List

|  | VEHICLE FAHRZEUG VEHICULE |  | VEHICLE FAHRZEUG VEHICULE |
|--|--|---|--|
| 553113▼ | Daihatsu Taft / Rocky / Wild Cat / Four Track - F | | Mazda Proceed / B Series - F |
| 553115 | Daihatsu Taft / Rocky / Wild Cat / Four Track - R | | Opel Campo/ Brava - F |
| 553116 | Mitsubishi L 200 - F | | Vauxhall Campo/ Brava - F |
| | Hyundai H 100 - R | 553177 | Mercedes Benz 190 Series (W201) - R |
| | Mitsubishi Delica, T Series - R | 553178 | Mercedes Benz E Series, E-Class (124) - R |
| | Mitsubishi L 300 / Delica - R | 553179 | Jaguar XJ Type (XJ 40, XJ 81 Series) - F |
| | Nissan Serena - R | 553180▼ | BMW 3 Series (E36) - R |
| | Nissan Serena Cargo, Vanette Cargo - R | 553181▼ | Ford Escort Turnier / Clipper Mk. V, VI, VII - R |
| 553117 | Toyota Lite-Ace - R | 553183 | Mercedes Benz C-Class (202) - F |
| | Toyota Hi-Lux - F | 553184 | Mercedes Benz C-Class (202) - F |
| | Volkswagen Taro - F | | Mercedes Benz E-Class (210) - F |
| 553118 | Toyota Hi-Lux - R | 553185 | Mercedes Benz C-Class (202) - R |
| | Volkswagen Taro - R | 553186 | Mercedes Benz C-Class (202) - R |
| 553119 | Bedford KB series - F | 553187 | Saab 9000 - R |
| | Isuzu Pick-up / Faster / Campo / Brava - F | 553189 | Mitsubishi L 200 - R |
| | Opel Campo/ Brava - F | | Toyota Hi-Lux - R |
| | Vauxhall Campo/ Brava - F | 553190 | Toyota Hi-Lux - R(L) |
| 553121▼ | Lada Niva - F | | Volkswagen Taro - R(L) |
| | Lada VAZ, Nova, Toscana - F | 553191 | Toyota Hi-Lux - R(R) |
| 553122 | Toyota Hi-Lux - F | | Volkswagen Taro - R(R) |
| 553132 | Volkswagen Transporter, Bus, Caravelle, Multivan - F | 553192▼ | BMW 3 Series Compact (E36) - R |
| 553137▼ | Bedford Astra, Chevanne, Rascal Van - R | 553193 | Mazda E Series / Bongo - R |
| | Opel Astra - R | | Mitsubishi Space Gear, L 400 - R |
| | Opel Kadett, Olympia, Aero - R | | Nissan Bluebird, Bluebird U - R |
| | Vauxhall Astra - R | 553197 | Toyota Dyna 150 - R |
| 553138▼ | Peugeot 205 - R | 553198 | Mercedes Benz E-Class (210) - F |
| | Peugeot 309 - R | 553199 | Mercedes Benz E-Class (210) - R |
| 553141▼ | Renault R 9, R 11 - R | 553200 | Mercedes Benz E-Class (210) - F |
| 553143 | Daihatsu Taft / Rocky / Wild Cat / Four Track - R | 553201▼ | Mercedes Benz E-Class (210) - R |
| | Mitsubishi L 300 / Delica - R | 553203▼ | Ford Escort Turnier / Clipper Mk. V, VI, VII - R |
| | Toyota Blizzard - R | 553204▼ | Toyota Dyna 150 - F |
| 553145▼ | Daihatsu Taft / Rocky / Wild Cat / Four Track - F | | Isuzu Trooper / Big Horn - R |
| | Nissan Vanette, Vanette Cargo - R | | Toyota Dyna - F |
| 553152 | Nissan Pick-up, Cab, King Cab, Navara, NP300 - F | 553205 | Alfa Romeo GTV - R |
| 553153 | Nissan Pick-up, Cab, King Cab, Navara, NP300 - R | | Alfa Romeo Spider - R |
| 553154 | Nissan Pick-up, Cab, King Cab, Navara, NP300 - R | 553206 | Audi A3 (8L1) - R |
| 553155▼ | Opel Corsa A, Corsa B - R | | Audi TT Coupé (8N3) - R |
| | Opel Tigra - R | | Audi TT Roadster (8N9) - R |
| | Vauxhall Nova, Corsa - R | | Seat Leon I - R |
| | Vauxhall Tigra - R | | Seat Toledo II - R |
| 553156▼ | Daihatsu Feroza / Sportrak - R | | Skoda Octavia I - R |
| 553158 | Suzuki Grand Vitara I - R | | Volkswagen Bora Variant - R |
| | Suzuki Santana SE416 Vitara - R | | Volkswagen Bora, Jetta IV - R |
| | Suzuki Vitara - R | | Volkswagen Golf IV - R |
| | Suzuki X-90 - R | | Volkswagen Golf IV Variant - R |
| 553159 | Nissan Pick-up, Cab, King Cab, Navara, NP300 - F | | Volkswagen New Beetle - R |
| 553160 | Toyota Hi-Lux - R | 553207 | Audi A6 (4B2), A6 Avant (4B5) - R |
| | Toyota Hi-Lux - R(L) | | Skoda Superb - R |
| 553162▼ | Opel Omega A, Omega B - R | | Volkswagen Passat - R |
| | Opel Senator, Monza - R | 553208 | Jaguar XJ Type (X300 Series) - F |
| | Opel Vectra A - R | 553209 | Ford-Mercury Ranger - R |
| | Vauxhall Carlton, Viceroy, Omega - R | | Mazda Proceed / B Series - R |
| | Vauxhall Cavalier, Vectra - R | | Toyota Hi-Lux - R |
| | Vauxhall Royale, Senator - R | | Volkswagen Taro - R |
| 553164▼ | Ford Transit - F | 553210▼ | Mitsubishi Space Gear, L 400 - R |
| 553171 | Ford-Mercury Ranger - F | 553211 | Mitsubishi Space Gear, L 400 - R |
| | Isuzu Pick-up / Faster / Campo / Brava - F | 553213 | Renault Master R Series - R |

NUMERICAL LISTING
 NUMERISCHE LISTE
 LISTE NUMERIQUE

|  | VEHICLE FAHRZEUG VEHICULE |  | VEHICLE FAHRZEUG VEHICULE |
|---|--|---|--|
| 553214 | Renault Master R Series - R | 553303▼ | Nissan Pathfinder - R |
| 553217 | Ford Mondeo - R | 553306 | Mercedes Benz C-Class (203) - R |
| 553218 | Renault Espace - R | 553307 | Opel Signum - R |
| 553219 | Renault Espace III - R | | Opel Vectra C - R |
| 553220 | Suzuki Jimny / Samurai / Santana - F | | Vauxhall Signum - R |
| 553221 | Suzuki Jimny / Samurai / Santana - R | | Vauxhall Vectra C - R |
| 553222 | Mitsubishi L 200 - R | 553308 | Ford Fiesta V - R |
| 553225 | Renault Clio II - R | | Mazda Mazda 2, Demio - R |
| | Renault Thalia, Symbol - R | 553309 | Ford Fusion - R |
| 553226 | Ford Sierra - R | 553333 | Chrysler PT-Cruiser - R |
| | Ford Sierra, XR-4, Cosworth - R | 553337 | Mercedes Benz Viano (W639) - R |
| 553228 | Nissan Pick-up, Cab, King Cab, Navara, NP300 - F | | Mercedes Benz Vito - R |
| 553229▼ | Nissan Pathfinder - R | 553338 | Mercedes Benz Viano (W639) - R |
| 553230 | Ford Maverick - R | | Mercedes Benz Vito - R |
| | Isuzu Pick-up / Faster / Campo / Brava - R | 553339 | Chevrolet - Daewoo Rezzo / Tacuma - R |
| | Nissan Terrano II - R | 553340 | Mercedes Benz A-Class - R |
| | Opel Campo/ Brava - R | | Mercedes Benz B-Class (W245) - R |
| | Vauxhall Campo/ Brava - R | 553356 | Mercedes Benz E-Class (211) - R |
| 553231 | Seat Inca - R | 553357 | Fiat Croma II (194) - R |
| | Volkswagen Polo Caddy - R | 553358 | Ford Focus II Turnier - R |
| 553232▼ | Skoda Octavia I Combi - R | 553359 | Mercedes Benz SLK (R171) - R |
| | Skoda Roomster, Praktik - R | 553363 | Chrysler Crossfire - F |
| | Volkswagen Bora Variant - R | 553364 | Chrysler Crossfire - R |
| | Volkswagen Golf IV Variant - R | 553365 | Honda Civic - R |
| 553233 | Toyota Hi-Lux - R | 553366 | Mercedes Benz CLK (209) - R |
| 553234 | Toyota Hi-Lux - R | 553367 | Mercedes Benz CLK (209) - R |
| 553235 | Toyota Hi-Lux - R(R) | 553379 | Mazda Mazda 2, Demio - R |
| 553236 | Mercedes Benz CLK (208) - F | 553381 | Mercedes Benz C-Class (C204) - R |
| 553237 | Mercedes Benz CLK (208) - F | | Mercedes Benz C-Class (S204) - R |
| | Mercedes Benz SLK (R170) - F | | Mercedes Benz C-Class (W204) - R |
| 553238 | Mercedes Benz CLK (208) - R | | Mercedes Benz E-Class (212) - R |
| 553239 | BMW 3 Series (E46) - R | | Mercedes Benz E-Class (A207) - R |
| | BMW 3 Series Compact (E46) - R | | Mercedes Benz E-Class (A238) - R |
| | BMW 3 Series Touring (E36) - R | | Mercedes Benz E-Class (C207) - R |
| | BMW 3 Series Touring (E46) - R | | Mercedes Benz E-Class (C238) - R |
| 553240 | Opel Astra - R | 553382 | Volvo XC90 I (275) - R |
| | Vauxhall Astra - R | 553384 | Mercedes Benz C-Class (S204) - R |
| 553241▼ | Opel Astra - R | | Mercedes Benz C-Class (W204) - R |
| | Vauxhall Astra - R | | Mercedes-Benz C-Class (205) - R |
| 553242 | Opel Combo - R | | Mercedes Benz E-Class (A238) - R |
| | Opel Meriva - R | | Mercedes Benz E-Class (C238) - R |
| | Opel Zafira I - R | | Mercedes Benz E-Class (W213) - R |
| | Vauxhall Combo - R | 553385 | Volvo S 60 - R |
| | Vauxhall Meriva - R | | Volvo S 70, V 70, C 70 - R |
| | Vauxhall Zafira I - R | | Volvo S 80 - R |
| 553243 | Audi A3 (8L1) - R | 553386 | Mercedes Benz GLK (X204) - R |
| | Audi TT Coupé (8N3) - R | 553388 | Mercedes Benz E-Class (212) - R |
| | Audi TT Roadster (8N9) - R | 553389 | Volvo V 40 - R |
| | Seat Leon I - R | | Volvo V40 Cross Country (525, 526) - R |
| | Volkswagen Bora Variant - R | 553390 | Volvo V40 Cross Country (525, 526) - R |
| | Volkswagen Bora, Jetta IV - R | 553393 | Smart Fortwo Coupé , Fortwo Cabrio - R |
| | Volkswagen Golf IV - R | 553604 | Mercedes Benz A-Class - R |
| | Volkswagen Golf IV Variant - R | 553803 | Renault Laguna II - R |
| 553244 | Ford Galaxy - R | | |
| | Seat Alhambra - R | | |
| | Volkswagen Sharan - R | | |
| 553245 | Mercedes Benz SLK (R170) - R | | |



| NUMERICAL LISTING NUMERISCHE LISTE LISTE NUMERIQUE | | | |
|--|--|---------------------------------|--|
| VEHICLE FAHRZEUG VEHICULE | | VEHICLE FAHRZEUG VEHICULE | |
| 5530000 Series | | 554070▼ | Ford Maverick - F Nissan Terrano - F Nissan Terrano II - F |
| 5530001 | Mercedes-Benz GLK (X204) - R | 554071▼ | Toyota 4-Runner / Hilux Surf - R |
| 5530005 | Mercedes Benz CLS-Class (C257) - R | 554074 | Mitsubishi L 200 - F |
| | Mercedes Benz E-Class (W213) - R | 554076▼ | Toyota Land Cruiser - F |
| 5530007 | Kia Carens III - R | 554077 | Alfa Romeo Alfa 145/146 - R |
| 5530009 | Mercedes Benz SLC (R172) - R | | Alfa Romeo Alfa 155 - R |
| | Mercedes Benz SLK (R172) - R | | Fiat Bravo, Brava (182) - R |
| 5538000 Series | | | Fiat Coupé (175) - R |
| 5538000 | Fiat 500 L - R | | Fiat Marea (185) - R |
| 5538001 | Mercedes Benz A-Class (W176) - R | | Fiat Multipla (186) - R |
| | Mercedes Benz B-Class (W246, W242) - R | | Fiat Palio Weekend - R |
| | Mercedes Benz CLA-Class (C117) - R | | Fiat Tempra (159) - R |
| | Mercedes Benz CLA-Class Shooting Brake (X117) - R | | Fiat Tempra Station Wagon / Familia (159) - R |
| 5538002 | Mercedes Benz A-Class (W176) - R | | Fiat Tipo (160) - R |
| | Mercedes Benz B-Class (W246, W242) - R | | Lancia Dedra (835) - R |
| | Mercedes Benz CLA-Class (C117) - R | | Lancia Delta - R |
| | Mercedes Benz CLA-Class Shooting Brake (X117) - R | 554078 | Ford Mondeo - R |
| 5538003 | Alfa Romeo Giulia (952_) - R | 554079 | Toyota Land Cruiser - F |
| 5538004 | Alfa Romeo Stelvio (949_) - R | 554085▼ | Ford Transit - R |
| 554000 Series | | 554086 | Fiat Barchetta (183) - R |
| 554003 | Mercedes Benz S Series (W108, W109) - R | | Fiat Punto (176) - R |
| | Mercedes Benz W Series (W110, W111) - R | | Lancia Y - R |
| | Mercedes Benz W Series (W113) - R | 554087 | Toyota Lite-Ace - F |
| 554004 | Mercedes Benz S Series (W116) - R | 554088▼ | Opel Omega A Caravan, Omega B Caravan - R |
| | Mercedes Benz S Series (W126) - R | | Vauxhall Carlton, Viceroy, Omega - R |
| | Mercedes Benz SL Series (W107)/(R107)/(C107) - R | 554091 | Mitsubishi Pajero / Shogun / Montero - F |
| | Mercedes Benz W Series (W114, W115) - R | 554092 | Mitsubishi Pajero / Shogun / Montero - R |
| | Mercedes Benz W Series (W123, C123, S123) - R | 554094 | Kia Sportage - R |
| 554015 | Porsche 911, 914, 924, 928, 944 - R | 554095▼ | Hyundai H 100 - F |
| 554017 | Austin-Rover Triumph - R | 554096 | Nissan Patrol / Safari - F |
| 554020 | Volvo P 142, P 144, P 145, P 164 - R | 554097 | Nissan Patrol / Safari - R |
| 554037 | Nissan Patrol / Safari - F | 554100 | Ford-Mercury Ranger - F |
| 554038 | Nissan Patrol / Safari - R | | Mazda Proceed / B Series - F |
| 554044▼ | Toyota Land Cruiser - F | 554101 | Ford-Mercury Ranger - R |
| 554046 | Mitsubishi Delica, T Series - F | | Mazda Proceed / B Series - R |
| | Mitsubishi L 300 / Delica - F | 554102 | Mitsubishi L 300 / Delica - F |
| | Toyota Hi-Ace - F | | Mitsubishi Space Gear, L 400 - F |
| 554047 | Nissan Urvan, Caravan - F | 554103 | Mitsubishi Space Gear, L 400 - F |
| 554048▼ | Ford Transit - F | 554104 | Nissan Fair Lady, 280 ZX, 300 ZX, 350 ZX - R |
| 554053 | Toyota Hi-Ace - R | 554105 | Mitsubishi L 200 - F |
| 554055▼ | Toyota Land Cruiser - F | 554111▼ | Nissan Serena - R |
| 554057▼ | Toyota Land Cruiser - F | 554112▼ | Nissan Patrol / Safari - F |
| 554060 | Volkswagen Transporter, Bus, Caravelle, Multivan - R | 554113 | Nissan Patrol / Safari - R |
| 554061▼ | Hyundai Galloper - F | 554114 | Jaguar XJ Type (X308 Series) - F |
| | Mitsubishi Galloper - F | 554145▼ | Kia Carnival / Sedona - R |
| | Mitsubishi Pajero / Shogun / Montero - F | 554147▼ | SsangYong Musso / Korando - R |
| 554062 | Mitsubishi L 300 / Delica - F | 554169▼ | Jeep Cherokee - F |
| 554064▼ | Ford Transit - R | 554185 | Jeep Liberty - R |
| 554066▼ | Volkswagen Transporter, Bus, Caravelle, Multivan - R | 554197 | GM Hummer H2 - R |
| 554068▼ | Hyundai Galloper - R | 554319 | GM Hummer H2 - F |
| | Mitsubishi Galloper - R | 554337 | GAZ Sobol - F |
| | Mitsubishi Pajero / Shogun / Montero - R | 554338▼ | Hyundai Terracan - F |
| 554069 | Toyota 4-Runner / Hilux Surf - F | 554384 | Hyundai Elantra - R |
| | Toyota Hi-Lux - F | | Hyundai Veloster (FS) - R |
| | Volkswagen Taro - F | | Kia Rio III - R |



| NUMERICAL LISTING NUMERISCHE LISTE LISTE NUMERIQUE | | | |
|--|--|-----------------------|--|
| KYB | VEHICLE FAHRZEUG VEHICULE | KYB | VEHICLE FAHRZEUG VEHICULE |
| 554385 | Hyundai Veloster - R | | Nissan Sunny - R(R) |
| 554387▼ | Kia Cerato II - R | | Nissan Sunny, Sunny Traveller / Q-bic - R(R) |
| 554402 | Kia Soul - R | 632047 | Nissan Cherry, Pulsar - R(L) |
| | Ford C-Max II (DXA/CB7, DXA/CEU) - R | | Nissan Sunny - R(L) |
| 5540000 Series | | | Nissan Sunny, Sunny Traveller / Q-bic - R(L) |
| 5540001 | Toyota Land Cruiser (_J15_) - R | 632050 | Suzuki Alto - F(R) |
| | Toyota Land Cruiser Prado (_J15_) - R | 632051 | Suzuki Alto - F(L) |
| 5540004 | Lexus IS III (_E3_) - R | 632061▼ | Suzuki Swift - F(R) |
| 5540008 | Nissan Qashqai II (J11, J11_) - R | 632062▼ | Suzuki Swift - F(L) |
| | Nissan X-Trail (T31) - R | 632067▼ | Suzuki Swift - R |
| | Renault Koleos - R | 632068▼ | Suzuki Swift - F(R) |
| | | 632069▼ | Suzuki Swift - F(L) |
| 555000 Series | | 632072 | Nissan 100 NX - R(R) |
| 555005▼ | Toyota Land Cruiser - R | | Nissan Sunny - R(R) |
| 555006▼ | Nissan Patrol / Safari - R | 632073 | Nissan 100 NX - R(L) |
| 555007 | Jaguar XJ Type (X300 Series) - R | | Nissan Sunny - R(L) |
| 555008 | Jaguar XJ Type (X308 Series) - R | 632078 | Nissan Micra, March - F(R) |
| 555010 | Jaguar XK8 (QEV) , XKR (QDV) - R | 632079 | Nissan Micra, March - F(R) |
| 555015▼ | Ford-Mercury Explorer - R | 632080 | Nissan Micra, March - F(L) |
| 555049 | GM Hummer H3 - F | 632089 | Daihatsu Charade - R(R) |
| 555050 | GM Hummer H3 - R | 632090 | Daihatsu Charade - R(L) |
| 555057 | Nissan Pathfinder - R | 632093 | Chevrolet - Daewoo Tico - F(R) |
| 555062 | Jeep Wrangler - F | 632094 | Suzuki Alto - F(R) |
| 555063▼ | Jeep Wrangler - R | | Chevrolet - Daewoo Tico - F(L) |
| 555608 | BMW X5 - R | | Suzuki Alto - F(L) |
| 555800 | Renault Mégane I Grandtour - R | 632097 | Daihatsu Cuore / Domino - F(R) |
| 5550000 Series | | 632098 | Daihatsu Cuore / Domino - F(L) |
| 5550001 | Volvo S 60 II - R | 632099 | Daihatsu Cuore / Domino - F(R) |
| | Volvo V 60 - R | 632100 | Daihatsu Cuore / Domino - F(L) |
| Premium Sealed Strut (63 - Series) | | | |
| 631000 Series | | | |
| 631004 | Renault R 21 - F | 632103▼ | Hyundai Accent, Pony, Excel - R(R) |
| | Renault R 21 Nevada, Société - F | 632104▼ | Hyundai Accent, Pony, Excel - R(L) |
| 631600 | Fiat Panda (141) - F | 632112▼ | Hyundai Accent, Pony, Excel - R(R) |
| 631601 | Fiat Fiorino, Fiorino Qubo - F | 632113▼ | Hyundai Accent, Pony, Excel - R(L) |
| 632000 Series | | 632116 | Chevrolet - Daewoo Matiz (UzDaewoo) - F(R) |
| 632004 | Mazda 323 - R(R) | | Chevrolet - Daewoo Matiz / Spark - F(R) |
| 632005 | Mazda 323 - R(L) | 632117 | Chevrolet - Daewoo Matiz (UzDaewoo) - F(L) |
| 632006 | Suzuki Alto - F | | Chevrolet - Daewoo Matiz / Spark - F(L) |
| 632011 | Nissan Micra, March - F(L) | 632131 | Subaru Justy, J Series - R |
| 632034 | Mazda 323 - R(R) | 632140 | Suzuki Alto - F(R) |
| 632035 | Mazda 323 - R(L) | 632141 | Suzuki Alto - F(L) |
| 632040 | Nissan Cherry, Pulsar - F(R) | 632801 | Ford Escort Mk. III, IV, XR-3 - R |
| | Nissan Sunny - F(R) | | Ford Orion - R |
| | Nissan Sunny, Sunny Traveller / Q-bic - F(R) | 6320000 Series | |
| 632041 | Nissan Cherry, Pulsar - F(L) | 6320001 | Kia Pride - F(R) |
| | Nissan Sunny - F(L) | | Mazda 121 - F(R) |
| | Nissan Sunny, Sunny Traveller / Q-bic - F(L) | 6320002 | Kia Pride - F(L) |
| 632042▼ | Isuzu Gemini - F(R) | | Mazda 121 - F(L) |
| 632043▼ | Isuzu Gemini - F(L) | 633000 Series | |
| 632044 | Daihatsu Charade - F(R) | 633028 | Mazda 626, Montrose - F(R) |
| 632045 | Daihatsu Charade - F(L) | 633029 | Mazda 626, Montrose - F(L) |
| 632046 | Nissan Cherry, Pulsar - R(R) | 633038▼ | Ford Sierra - F |
| | | | Ford Sierra, XR-4, Cosworth - F |

NUMERICAL LISTING
 NUMERISCHE LISTE
 LISTE NUMERIQUE

Numerical List

|  | VEHICLE FAHRZEUG VEHICULE |  | VEHICLE FAHRZEUG VEHICULE |
|--|---|---|--|
| 633040 | Mitsubishi Colt - F Mitsubishi Lancer - F Mitsubishi Lancer Estate - F Proton Saga, Proton, Proton MPI - F | 633150 | Mitsubishi Lancer - F(L) Mitsubishi Lancer Estate - F(L) Hyundai Pony, Excel - F Hyundai S-Coupé - F |
| 633044 | Fiat Regata (138) - R Fiat Ritmo / Strada (138) - R Seat Strada / Ritmo - R | 633174▼ | Subaru Justy, J Series - R Suzuki Swift - R |
| 633048▼ | Fiat Regata (138) - F Fiat Regata Weekend (138) - F Fiat Ritmo / Strada (138) - F | 633175▼ | Daihatsu Charade - R(R) |
| 633049 | Mazda 323 - F(R) | 633176▼ | Daihatsu Charade - R(L) |
| 633050 | Mazda 323 - F(L) | 633177▼ | Hyundai Accent, Pony, Excel - F(R) |
| 633059 | Mitsubishi Colt - F Mitsubishi Lancer - F Mitsubishi Lancer Estate - F | 633178▼ | Hyundai Accent, Pony, Excel - F(L) |
| 633065▼ | Isuzu Gemini - F(R) | 633179▼ | Hyundai Lantra - F(R) |
| 633066▼ | Isuzu Gemini - F(L) | 633180▼ | Hyundai Lantra - F(L) |
| 633069 | Mazda 626, Montrose - F(R) | 633181▼ | Hyundai Lantra - R(R) |
| 633070 | Mazda 626, Montrose - F(L) | 633182▼ | Hyundai Lantra - R(L) |
| 633088 | Mazda 323 - R(R) Mazda 323 F - R(R) | 633185▼ | Suzuki Baleno - R(R) |
| 633089 | Mazda 323 - R(L) Mazda 323 F - R(L) | 633186▼ | Suzuki Baleno - R(L) |
| 633111▼ | Mazda 323 - R(R) | 633202 | Chevrolet - Daewoo Nubira - R(R) Chevrolet - Daewoo Nubira II - R(R) |
| 633112▼ | Mazda 323 - R(L) | 633203 | Chevrolet - Daewoo Nubira - R(L) Chevrolet - Daewoo Nubira II - R(L) |
| 633113▼ | Mazda 323 - F(R) | 633204▼ | Hyundai Atos - F(R) |
| 633114▼ | Mazda 323 - F(L) | 633205▼ | Hyundai Atos - F(L) |
| 633115 | Nissan 100 NX - F(R) Nissan Sunny - F(R) Nissan Sunny, Sunny Traveller / Q-bic - F(R) | 633206 | Subaru Justy, J Series - F(R) |
| 633116 | Nissan 100 NX - F(L) Nissan Sunny - F(L) Nissan Sunny, Sunny Traveller / Q-bic - F(L) | 633207 | Subaru Justy, J Series - F(L) |
| 633117 | Daihatsu Hijet - F(R) Piaggio Porter - F(R) | 633221▼ | Suzuki Baleno - F(R) |
| 633118 | Daihatsu Hijet - F(L) Piaggio Porter - F(L) | 633222▼ | Suzuki Baleno - F(L) |
| 633122 | Volvo 400 Series - F(R) | 633248▼ | Kia Sephia I - F(R) |
| 633123 | Volvo 400 Series - F(L) | 633249▼ | Kia Sephia I - F(L) |
| 633131▼ | Daihatsu Charade - R(R) | 633250▼ | Kia Sephia I - R(R) |
| 633132▼ | Daihatsu Charade - R(L) | 633251▼ | Kia Sephia I - R(L) |
| 633133 | Subaru Justy, J Series - F(R) Suzuki Swift - F(R) | 633261▼ | Piaggio Porter - F(R) |
| 633134 | Subaru Justy, J Series - F(L) Suzuki Swift - F(L) | 633262▼ | Piaggio Porter - F(L) |
| 633135 | Mitsubishi Lancer Estate - F(R) | 633265▼ | Daihatsu Terios - F(R) |
| 633136 | Mitsubishi Lancer Estate - F(L) | 633266▼ | Daihatsu Terios - F(L) |
| 633137 | Mazda 323 - F(R) | 633276 | Seat Arosa (6H) - F Seat Cordoba Vario (6K) - F Seat Ibiza, Cordoba (6K, 6K/C) - F Seat Inca (6K) - F Seat Toledo I (1L) - F Volkswagen Golf II, Jetta II - F Volkswagen Golf III Variant (1H) - F Volkswagen Golf III, Vento, Jetta III (1H) - F Volkswagen Lupo (6X) - F Volkswagen Polo Caddy (9K) - F Volkswagen Polo, Derby (6N1, 6N2, 6KV2) - F Volkswagen Polo, Polo Variant (6KV5, 6NF) - F |
| 633138 | Mazda 323 - F(L) | 633706 | Renault Clio I - F |
| 633143 | Mazda 323 - R(R) Mazda 323 F - R(R) | 633707 | Renault Clio II - F Renault Thalia, Symbol (LB0/1/2) - F Renault Thalia II, Symbol II (LU1/2_) - F |
| 633144 | Mazda 323 - R(L) Mazda 323 F - R(L) | 633708 | Renault Clio II - F Renault Thalia, Symbol - F |
| 633147 | Mitsubishi Colt - F(R) Mitsubishi Lancer - F(R) Mitsubishi Lancer Estate - F(R) | 633713 | Seat Leon I - F Seat Toledo II - F Skoda Octavia I - F Skoda Octavia I Combi - F |
| 633148 | Mitsubishi Colt - F(L) | | Volkswagen Bora Variant - F |

NUMERICAL LISTING
 NUMERISCHE LISTE
 LISTE NUMERIQUE

| KYB | VEHICLE FAHRZEUG VEHICULE | KYB | VEHICLE FAHRZEUG VEHICULE |
|------------|--|-----------------------|---|
| 633717 | Volkswagen Bora, Jetta IV - F | 633831 | Peugeot 309 - F |
| 633718 | Volkswagen Golf IV - F | | Opel Combo - F |
| | Volkswagen Golf IV Variant - F | | Opel Corsa A, Corsa B - F |
| | Renault Laguna II - F | | Vauxhall Combo - F |
| | Renault Mégane II - F | 633832 | Vauxhall Nova, Corsa - F |
| 633727 | Renault Mégane II Grandtour - F | | Ford Sierra - F |
| 633728 | Peugeot 406 - F(R) | | Ford Sierra, XR-4, Cosworth - F |
| 633729 | Peugeot 406 - F(L) | 633833 | Fiat Uno (146) - F |
| | Peugeot 206 - F(R) | 633834▼ | Ford Escort Mk. III, IV, XR-3 - F |
| | Peugeot 206 + - F(R) | | Ford Orion - F |
| 633730 | Peugeot 206 - F(L) | 633835 | Skoda Favorit - F |
| | Peugeot 206 + - F(L) | | Skoda Felicia - F |
| 633731 | Fiat Cinquecento (170) - F | | Skoda Forman - F |
| 633744 | Renault Clio Grandtour - F | | Skoda Pick-Up, Felicia Pick-Up - F |
| | Renault Clio III - F | | Volkswagen Golf Caddy - F |
| 633801 | Ford Escort Mk. III, IV, XR-3 - F | 633836 | Citroën ZX - F(R) |
| 633802 | Ford Escort Mk. III, IV, XR-3 - F | 633837 | Citroën ZX - F(L) |
| | Ford Orion - F | 633838 | Citroën Berlingo - F(R) |
| 633803 | Ford Fiesta Van, Courier - F | | Citroën Xsara (N1/N0) - F(R) |
| | Ford Fiesta, XR-2 - F | | Citroën Xsara (N2) - F(R) |
| 633804 | Renault R 5 (Super 5) - F | | Citroën ZX - F(R) |
| 633805 | Renault R 5 (Super 5) - F | | Peugeot 306 - F(R) |
| 633806 | Renault R 5 (Super 5) Express, Rapide, Extra - F | | Peugeot Partner, Ranch - F(R) |
| 633807 | Renault R 9, R 11 - F | 633839 | Citroën Berlingo - F(L) |
| 633808 | Renault R 19 / Chamade - F | | Citroën Xsara (N1/N0) - F(L) |
| 633813 | Seat Ibiza, Cordoba - F | | Citroën Xsara (N2) - F(L) |
| | Seat Malaga - F | | Citroën ZX - F(L) |
| 633814▼ | Seat Ibiza, Cordoba - R | | Peugeot 306 - F(L) |
| | Seat Malaga - R | | Peugeot Partner, Ranch - F(L) |
| | Seat Ronda - R | 633840▼ | Seat Ibiza, Cordoba - F |
| 633815 | Fiat Ritmo / Strada (138) - R | | Seat Malaga - F |
| | Seat Ibiza, Cordoba - R | 633847 | Renault R 5 (Super 5) Express, Rapide, Extra - F |
| | Seat Malaga - R | 633848 | Nissan Kubistar - F |
| 633818 | Ford Fiesta Van, Courier - F | | Renault Kangoo - F |
| | Ford Fiesta, XR-2 - F | 633874 | Seat Panda, Marbella - F |
| 633820 | Ford Escort Mk. V, VI, XR-3, RS - F | | Seat Terra, Trans - F |
| | Ford Escort Turnier / Clipper Mk. V, VI, VII - F | 633951 | Fiat Panda (141) - F |
| | Ford Escort Van, Express - F | | Seat Panda, Marbella - F |
| | Ford Orion - F | | Seat Terra, Trans - F |
| 633821 | Ford Escort Mk. V, VI, XR-3, RS - F | 6338000 Series | |
| | Ford Escort Turnier / Clipper Mk. V, VI, VII - F | 6338001 | Renault Thalia, Symbol (LB0/1/2) - F |
| | Ford Escort Van, Express - F | | Renault Thalia II, Symbol II (LU1/2_) - F |
| | Ford Orion - F | 634000 Series | |
| 633822 | Ford Fiesta, XR-2 - F | 634001 | Mitsubishi Cordia & Tredia - F |
| 633824 | Renault Clio I - F | 634010 | Mitsubishi Space Wagon, Space Van (Chariot), Expo - F |
| 633825 | Renault Clio I - F | | Citroën Visa - F(R) |
| 633827 | Renault Mégane I Grandtour - F | | Peugeot 205 - F(R) |
| | Renault Mégane I, Mégane Classic - F | | Peugeot 309 - F(R) |
| | Renault Mégane I, Mégane Coach - F | 634011 | Citroën Visa - F(L) |
| | Renault Scénic I - F | | Peugeot 205 - F(L) |
| | Renault Scénic I (96-03) - F | | Peugeot 309 - F(L) |
| 633828 | Citroën C 15 - F | 634015 | Ford Scorpio/ Granada (GAE/GGE) - F |
| | Citroën Visa - F | | |
| | Peugeot 205 - F | | |
| 633829 | Peugeot 305 - F | | |
| | Peugeot 405 - F | | |
| 633830 | Peugeot 205 - F | | |

NUMERICAL LISTING
 NUMERISCHE LISTE
 LISTE NUMERIQUE

Numerical List

| KYB | VEHICLE FAHRZEUG VEHICULE | KYB | VEHICLE FAHRZEUG VEHICULE |
|------------|---|------------|---|
| 634021 | Opel Omega A Caravan, Omega B Caravan - F(R) Opel Omega A, Omega B - F(R) Opel Senator , Monza - F(R) Vauxhall Carlton, Viceroy, Omega - F(R) Vauxhall Royale, Senator - F(R) | 634067▼ | Rover 400 Series - F(R) Rover 200 Series - F(L) Rover 400 Series - F(L) |
| 634022 | Opel Omega A Caravan, Omega B Caravan - F(L) Opel Omega A, Omega B - F(L) Opel Senator , Monza - F(L) Vauxhall Carlton, Viceroy, Omega - F(L) Vauxhall Royale, Senator - F(L) | 634072 | Suzuki Santana SE416 Vitara - F(R) Suzuki Vitara - F(R) Suzuki X-90 - F(R) |
| 634023▼ | Mitsubishi Galant, Sapporo (Lambda), Sigma - F | 634073 | Suzuki Santana SE416 Vitara - F(L) Suzuki Vitara - F(L) Suzuki X-90 - F(L) |
| 634024 | Mazda 626 - F(R) Mazda 626, Montrose - F(R) | 634074 | Nissan Serena - F(R) Nissan Serena Cargo, Vanette Cargo - F(R) |
| 634025 | Mazda 626 - F(L) Mazda 626, Montrose - F(L) | 634075 | Nissan Serena - F(L) Nissan Serena Cargo, Vanette Cargo - F(L) |
| 634026 | Mazda 626, Montrose - R | 634080 | Mazda 626, Montrose - R |
| 634027▼ | Nissan Bluebird, Bluebird U - F(R) | 634081▼ | Nissan Bluebird, Bluebird U - F(R) |
| 634028▼ | Nissan Bluebird, Bluebird U - F(L) | 634082▼ | Nissan Bluebird, Bluebird U - F(L) |
| 634030▼ | Mazda 626 - F(R) Mazda 626, Montrose - F(R) | 634089▼ | Suzuki Grand Vitara I - F(R) |
| 634031▼ | Mazda 626 - F(L) Mazda 626, Montrose - F(L) | 634090▼ | Suzuki Grand Vitara I - F(L) |
| 634034▼ | Mitsubishi Galant, Sapporo (Lambda), Sigma - F | 634091▼ | Chevrolet - Daewoo Nubira - F(R) |
| 634036▼ | Nissan 100 NX - R(R) Nissan Sunny - R(R) | 634092▼ | Chevrolet - Daewoo Nubira - F(L) |
| 634037▼ | Nissan 100 NX - R(L) Nissan Sunny - R(L) | 634095 | Chevrolet - Daewoo Leganza - F(R) |
| 634038▼ | Nissan 100 NX - R(R) Nissan Sunny - R(R) | 634096 | Chevrolet - Daewoo Leganza - F(L) |
| 634039▼ | Nissan 100 NX - R(L) Nissan Sunny - R(L) | 634097 | Chevrolet - Daewoo Leganza - R(R) |
| 634040▼ | Rover 200 Series - F(R) Rover 400 Series - F(R) | 634098 | Chevrolet - Daewoo Leganza - R(L) |
| 634041▼ | Rover 200 Series - F(L) Rover 400 Series - F(L) | 634100▼ | Kia Clarus - F(R) |
| 634042 | Hyundai Santamo - F Kia Joice - F Mitsubishi Santamo - F Mitsubishi Space Runner - F Mitsubishi Space Wagon, Space Van (Chariot), Expo - F | 634101▼ | Kia Clarus - F(L) |
| 634043▼ | Hyundai Santamo - F Mitsubishi Santamo - F Mitsubishi Space Runner - F Mitsubishi Space Wagon, Space Van (Chariot), Expo - F | 634110 | Daihatsu Terios - F(R) |
| 634044 | Mazda 626, Montrose - F(R) Mazda MX-6 - F(R) | 634111 | Daihatsu Terios - F(L) |
| 634045 | Mazda 626, Montrose - F(L) Mazda MX-6 - F(L) | 634600 | Renault Scénic I (96-03) - F |
| 634046 | Mazda 626, Montrose - R Mazda MX-6 - R | 634802 | Renault Laguna I - F |
| 634050 | Hyundai Lantra - F | 634807 | Renault Laguna I - F |
| 634051 | Mazda 626, Montrose - F(R) | 634810 | Seat Cordoba Vario - F Seat Ibiza, Cordoba - F Seat Toledo I - F Volkswagen Corrado - F Volkswagen Golf Cabrio - F Volkswagen Golf II, Jetta II - F Volkswagen Golf III Variant - F Volkswagen Golf III, Vento , Jetta III - F Volkswagen Passat - F Volkswagen Polo, Derby - F Volkswagen Polo, Polo Variant - F |
| 634052 | Mazda 626, Montrose - F(L) | 634811 | Volkswagen Passat - F |
| 634063▼ | Hyundai Sonata / Sonica - F | 634812 | Audi A3 (8L1) - F Seat Leon I - F Seat Toledo II - F Skoda Octavia I - F Skoda Octavia I Combi - F Volkswagen Bora Variant - F Volkswagen Bora, Jetta IV - F Volkswagen Golf IV - F Volkswagen Golf IV Variant - F |
| 634064▼ | Rover 800 Series - R(R) | 634814 | Renault Espace - F |
| 634065▼ | Rover 800 Series - R(L) | 634908 | Renault VelSatis - F |
| 634066▼ | Rover 200 Series - F(R) | 634927 | Volvo 850 - F Volvo S 70, V 70, C 70 - F Citroën Evasion / Synergie - F |

| NUMERICAL LISTING NUMERISCHE LISTE LISTE NUMERIQUE | | | |
|--|---|----------------------|--|
| KYB | VEHICLE FAHRZEUG VEHICULE | KYB | VEHICLE FAHRZEUG VEHICULE |
| 634928 | Fiat Ulysse - F Lancia Zeta - F Peugeot 806 - F Citroën Jumpy / Dispatch - F Fiat Scudo (220) - F Peugeot Expert - F | 663032 | Daihatsu Charmant - F |
| | | 663035 | Toyota Corolla & Sprinter - F |
| | | | Audi 50 - F |
| | | 663039 | Volkswagen Polo, Derby - F |
| | | 663045 | Toyota Tercel & Corsa - F |
| | | 663046 | Toyota Corolla & Sprinter - F |
| | | 663500 | Peugeot 404 - F |
| | | | BMW 3 Series (E30) - F |
| 635000 Series | | 664000 Series | |
| 635001 | Ford Transit - F | 664001 | Audi 80 (72-78) - F |
| 635002 | Mazda 626 - R | | Volkswagen Passat, Santana - F |
| 635009 | Mazda MPV - F(R) | 664004 | Citroën LN, LNA - F |
| 635010 | Mazda MPV - F(L) | | Peugeot 104 - F |
| 635011 | Nissan Pathfinder - F(R) | | Renault R 14 - F |
| 635012 | Nissan Pathfinder - F(L) | 664006 | Peugeot 204, 304 - F |
| 635800 | Ford Transit - F | 664007 | Peugeot 504 - F |
| 635806 | Citroën Jumper / Relay - F | 664008 | Peugeot 504 - F |
| | Fiat Ducato - F | | Peugeot 505 - F |
| | Peugeot Boxer - F | | Peugeot 604 - F |
| 635807 | Citroën Jumper / Relay - F | | Talbot Tagora - F |
| | Fiat Ducato - F | 664012 | Nissan Violet, Stanza, Auster - R |
| | Peugeot Boxer - F | 664014 | Volkswagen Golf II, Jetta II - F |
| 635850 | Citroën C 25 - F | 664016 | Nissan Bluebird, Bluebird U - R |
| | Fiat Ducato - F | 664017 | Peugeot 104 - F |
| | Peugeot J5 - F | 664018 | Peugeot 504 - F |
| 635851 | Citroën C 25 - F | | Peugeot 505 - F |
| | Fiat Ducato - F | | Peugeot 604 - F |
| | Fiat Talento (290) - F | 664020 | Nissan Bluebird, Bluebird U - R |
| | Peugeot J5 - F | | |
| 635902 | Renault R 21 - F(R) | 665000 Series | |
| | Renault R 21 Nevada, Société - F(R) | 665001 | BMW 5 Series (E12) - F |
| 635903 | Renault R 21 - F(L) | | BMW 6 Series (E24) - F |
| | Renault R 21 Nevada, Société - F(L) | 665002 | Ford Taunus - F |
| 635908 | Renault Trafic P Series - F(R) | 665004 | Ford Capri - F |
| | Renault Trafic T Series - F(R) | 665008 | Volvo 242, 244, 245, 264, 265, 240, 260 Series - F |
| 635909 | Renault Trafic P Series - F(L) | 665009 | Volvo 66 - F |
| | Renault Trafic T Series - F(L) | 665010 | Volvo 300 Series - F |
| | | 665021 | Toyota Carina - F |
| 6410000 Series | | | Toyota Celica - F |
| 6410001 | Kia Pride - R | | Toyota Corolla & Sprinter - F |
| Premium Cartridge (66 - Series) | | | Toyota Corona - F |
| | | 665022▼ | Daihatsu Charmant - F |
| | | | Toyota Corolla & Sprinter - F |
| | | 665024▼ | Toyota Carina - F |
| | | | Toyota Celica - F |
| | | | Toyota Corona - F |
| 663000 Series | | 665030 | Audi 80, 80 Variant/Avant [91-95] - F |
| 663001 | BMW E 10 Series - F | | Audi 80/90, 80 Variant/Avant [78-91] - F |
| 663002 | BMW 3 Series (E21) - F | | Audi Coupé - F |
| 663003 | Ford Escort Mk. I, II - F | | Volkswagen Passat, Santana - F |
| 663004 | Ford Escort Mk. I, II - F | 665035 | Opel Commodore - F |
| | Ford Escort Van, Express - F | | Opel Rekord - F |
| 663005 | Porsche 911, 914, 924, 928, 944 - F | | Opel Rekord Caravan - F |
| 663007 | Volkswagen Käfer / Beetle / Coccinelle / Kever - F | | Vauxhall Carlton, Viceroy, Omega - F |
| 663008▼ | Volkswagen Käfer / Beetle / Coccinelle / Kever - F | | |
| 663009 | Volkswagen Golf Cabrio - F | | |
| | Volkswagen Golf Caddy - F | | |
| | Volkswagen Golf I, Jetta I - F | | |
| | Volkswagen Scirocco - F | | |
| 663031 | Daihatsu Charmant - F | | |
| | Toyota Corolla & Sprinter - F | | |

NUMERICAL LISTING
 NUMERISCHE LISTE
 LISTE NUMERIQUE



Numerical List

| KYB | VEHICLE FAHRZEUG VEHICULE | KYB | VEHICLE FAHRZEUG VEHICULE |
|---|--|--|--|
| 665036 | Bedford Astra, Chevanne, Rascal Van - F Chevrolet - Daewoo Espero / Aranos - F Chevrolet - Daewoo Lanos / Sens - F Chevrolet - Daewoo Nexia / Cielo - F Opel Kadett, Olympia, Aero - F Vauxhall Astra - F Vauxhall Belmont - F | RN-002 | Audi 80/90, 80 Variant/Avant - F Audi 80/90, 80 Variant/Avant - R Audi 80, 80 Variant/Avant - F Audi Cabrio (8G) - F Audi Coupé - F |
| 665042 | Opel Ascona, Manta - F Vauxhall Cavalier, Vectra - F | Spring Seat/Federteller/Assiette de Ressort | |
| 665046▼ | Toyota Camry - F | SG-701 | Seat Cordoba Vario - R Seat Ibiza, Cordoba - R Volkswagen Polo, Derby - R Volkswagen Polo, Polo Variant - R |
| 665047▼ | Toyota Carina II - F Toyota Corolla & Sprinter - F | SG-703 | Audi A4 (8D2), A4 Avant (8D5) - R |
| 665055 | Volvo 740, 745, 760 - F Volvo 740, 760 - F Volvo 780 - F Volvo 940 - F Volvo 960 - F | SG-704 | Citroën Jumper / Relay - F Fiat Ducato - F Peugeot Boxer - F |
| 665056 | Opel Rekord - F Opel Senator, Monza - F Vauxhall Carlton, Viceroy, Omega - F Vauxhall Royale, Senator - F | SP-001 | Seat Toledo I (1L) - R Volkswagen Corrado - R Volkswagen Golf II, Jetta II - R Volkswagen Golf III, Vento, Jetta III - R Volkswagen Golf Cabrio - R Volkswagen Passat - R Volkswagen Passat, Santana - R |
| 665057 | Opel Ascona, Manta - F Vauxhall Cavalier, Vectra - F | | |
| 665058▼ | Nissan Laurel - F | | |
| 665059 | Lada Samara, Riva, Diva, Forma, Sagona - F | | |
| 665062 | Peugeot 504 - F | | |
| 665063 | Opel Calibra - F Opel Vectra A - F Vauxhall Calibra - F Vauxhall Cavalier, Vectra - F | | |
| 665065 | Peugeot 505 - F | | |
| 665500 | Volkswagen Passat - F | | |
| 665501 | Bedford Astra, Chevanne, Rascal Van - F Opel Astra - F Vauxhall Astra - F | | |
| 665502 | Citroën AX - F Citroën Saxo - F Peugeot 106 I, 106 II - F | | |
| 665503 | Lada 110 / 111 / 112 - F | | |
| 666000 Series | | | |
| 666001 | Audi 100, 100 Avant - F Audi 200, 200 Avant - F Audi A6 (4A), A6 Avant (4A) - F | | |
| 666002 | Audi 80/90, 80 Variant/Avant [78-91] - R Audi Coupé - R | | |
| Locking Ring/Sicherungsring/ Rondelle de blocage | | | |
| RN-001 | Audi 50 - F Volkswagen Golf I, Jetta I - F Volkswagen Golf II, Jetta II - F Volkswagen Golf Cabrio - F Volkswagen Polo, Derby - F Volkswagen Scirocco - F | | |

| | VEHICLE FAHRZEUG VEHICULE | | VEHICLE FAHRZEUG VEHICULE |
|---|--|---|--------------------------------------|
| Mono Tube Gas Shock Absorber (24 - Series) | | 244039▼ | Fiat Punto (176) - R Lancia Y - R |
| 241006 | Citröen AX - R Citröen Saxo - R | Twin Tube Gas Sealed Strut (32 - Series) | |
| 241008 | Peugeot 106 I, 106 II - R Citröen Xsara (N1/N0) - R Citröen Xsara (N2) - R Citröen ZX - R | 321002 | Subaru Impreza (GD, GG) - F(R) |
| 241009 | Peugeot 306 - R | 321003 | Subaru Impreza (GD, GG) - F(L) |
| 241010 | Renault Clio I - R | 321004 | Subaru Impreza (GD, GG) - R(R) |
| 241011 | Renault Clio I - R | 321005 | Subaru Impreza (GD, GG) - R(L) |
| 241012 | Renault Mégane I, Mégane Classic - R | 321006 | Subaru Impreza (GD, GG) - F(R) |
| 243014 | Renault Mégane I, Mégane Classic - R | 321007 | Subaru Impreza (GD, GG) - F(L) |
| 243014 | Renault Mégane I, Mégane Coach - R | 321008 | Subaru Impreza (GD, GG) - R(R) |
| 243014 | Chevrolet - Daewoo Espero / Aranos - R | 321009 | Subaru Impreza (GD, GG) - R(L) |
| 243014 | Chevrolet - Daewoo Lanos / Sens - R | 323034 | Opel Corsa A, Corsa B - F |
| 243014 | Chevrolet - Daewoo Nexia / Cielo - R | 323034 | Opel Tigra - F |
| 243014 | Opel Astra - R | 323034 | Vauxhall Nova, Corsa - F |
| 243014 | Opel Insignia A - R | 323034 | Vauxhall Tigra - F |
| 243014 | Opel Insignia A Country Tourer - R | 323052 | Hyundai Accent, Pony, Excel - F(R) |
| 243014 | Opel Insignia A Sports Tourer - R | 323053 | Hyundai Accent, Pony, Excel - F(L) |
| 243014 | Opel Kadett, Olympia, Aero - R | 323054▼ | Peugeot 206 - F(R) |
| 243014 | Opel Vectra A - R | 323054▼ | Peugeot 206 + - F(R) |
| 243014 | Vauxhall Astra - R | 323054▼ | Peugeot 206 CC - F(R) |
| 243014 | Vauxhall Belmont - R | 323055▼ | Peugeot 206 SW - F(R) |
| 243014 | Vauxhall Cavalier, Vectra - R | 323055▼ | Peugeot 206 - F(L) |
| 243015 | Lada Niva - F | 323055▼ | Peugeot 206 + - F(L) |
| 243015 | Lada VAZ, Nova, Toscana - F | 323055▼ | Peugeot 206 CC - F(L) |
| 243016 | Lada Niva - R | 323056 | Peugeot 206 SW - F(L) |
| 243019 | Lada VAZ, Nova, Toscana - R | 323056 | Ford Focus - F(R) |
| 243019 | BMW 3 Series (E30) - R | 323057 | Ford Focus - F(L) |
| 243024▼ | BMW 3 Series Touring (E30) - R | 323058 | Toyota Yaris I - F |
| 243032 | Nissan Pick-up, Cab, King Cab, Navara, NP300 - F | 323061 | Nissan Almera (N16) - F(R) |
| 243032 | Mercedes Benz 190 Series (W201) - R | 323061 | Nissan Almera (N16E) - F(R) |
| 243033 | Mercedes Benz E Series, E-Class (124) - R | 323062 | Nissan Almera (N16) - F(L) |
| 243034 | Toyota RAV 4 - R | 323062 | Nissan Almera (N16E) - F(L) |
| 243034 | Ford Escort Mk. V, VI, XR-3, RS - R | 323063 | Toyota Corolla - F(R) |
| 243037 | Ford Sierra - R | 323064 | Toyota Corolla - F(L) |
| 243037 | Ford Sierra, XR-4, Cosworth - R | 323731 | Fiat Cinquecento (170) - F |
| 243037 | Audi A3 (8L1) - R | 323731 | Fiat Seicento Van (187) - F |
| 243037 | Seat Leon I - R | 323734 | Citröen Xsara (N1/N0) - F(R) |
| 243037 | Seat Toledo II - R | 323734 | Citröen Xsara (N2) - F(R) |
| 243037 | Skoda Octavia I - R | 323735 | Citröen Xsara (N1/N0) - F(L) |
| 243037 | Volkswagen Bora Variant - R | 323735 | Citröen Xsara (N2) - F(L) |
| 243037 | Volkswagen Bora, Jetta IV - R | 323808 | Renault R 19 / Chamade - F |
| 243037 | Volkswagen Golf IV - R | 323825 | Renault Clio I - F |
| 243037 | Volkswagen Golf IV Variant - R | 323827 | Renault Mégane I Grandtour - F |
| 243037 | Volkswagen New Beetle - R | 323827 | Renault Mégane I, Mégane Classic - F |
| 243040 | Suzuki Grand Vitara I - R | 323838 | Renault Mégane I, Mégane Coach - F |
| 244029 | Opel Ascona, Manta - F | 323838 | Citröen Xsara (N1/N0) - F(R) |
| 244029 | Opel Cavalier, Vectra - F | 323838 | Citröen Xsara (N2) - F(R) |
| 244029 | Opel Chevette - F | 323839 | Citröen ZX - F(R) |
| 244029 | Opel Kadett, Olympia, Aero - F | 323839 | Peugeot 306 - F(R) |
| 244030▼ | Opel Ascona, Manta - R | 323839 | Citröen Xsara (N1/N0) - F(L) |
| 244030▼ | Opel Cavalier, Vectra - R | 323839 | Citröen Xsara (N2) - F(L) |
| 244030▼ | Opel Chevette - R | 323839 | Citröen ZX - F(L) |
| 244030▼ | Opel Kadett, Olympia, Aero - R | 323849 | Peugeot 306 - F(L) |
| 244030▼ | | 323849 | Renault Clio I - F |

| KYB | VEHICLE FAHRZEUG VEHICULE | KYB | VEHICLE FAHRZEUG VEHICULE |
|------------|---|------------|--|
| 324007▼ | Mercedes Benz 190 Series (W201) - F Mercedes Benz E Series, E-Class (124) - F | 324055 | Subaru Forester - R(L) |
| 324012 | Peugeot 205 - F(R) Peugeot 309 - F(R) | 324056 | Toyota RAV 4 - F(R) |
| 324013 | Peugeot 205 - F(L) Peugeot 309 - F(L) | 324057 | Toyota RAV 4 - F(L) |
| 324015 | Ford Escort Mk. V, VI, XR-3, RS - F Ford Sierra - F | 324700 | Toyota Corolla - F(R) |
| 324016 | Audi A3 (8L1) - F Seat Leon I - F Seat Toledo II - F Skoda Octavia I - F Volkswagen Bora Variant - F Volkswagen Bora, Jetta IV - F Volkswagen Golf IV - F Volkswagen Golf IV Variant - F Volkswagen New Beetle - F | 324701 | Toyota Corolla - F(L) |
| 324025 | Seat Arosa - F Seat Cordoba Vario - F Seat Ibiza, Cordoba - F Seat Inca - F Seat Toledo I - F Volkswagen Corrado - F Volkswagen Golf Cabrio - F Volkswagen Golf II, Jetta II - F Volkswagen Golf III Variant - F Volkswagen Golf III, Vento, Jetta III - F Volkswagen Lupo - F Volkswagen Passat - F Volkswagen Polo Caddy - F Volkswagen Polo, Derby - F Volkswagen Polo, Polo Variant - F | 324702 | Audi A2 (8Z0) - F Seat Ibiza, Cordoba - F Skoda Fabia - F Skoda Roomster, Praktik - F Volkswagen Fox (5Z1) - F Volkswagen Polo - F |
| 324030 | Subaru Impreza (GD, GG) - R(R) | 324703 | Audi A3 (8P1), A3 (8P7) - F Audi A3 Sportback (8PA) - F Seat Altea, Altea XL - F Seat Leon II - F Seat Toledo III - F Skoda Octavia II - F Skoda Octavia II Combi - F Skoda Yeti - F Volkswagen Golf V - F Volkswagen Golf V Plus - F Volkswagen Golf V Variant - F Volkswagen Golf VI - F Volkswagen Golf VI Variant - F Volkswagen Jetta V - F Volkswagen Jetta VI - F |
| 324031 | Subaru Impreza (GD, GG) - R(L) | 324805 | Fiat Punto (176) - F Lancia Y - F |
| 324032 | Subaru Impreza (GD, GG) - F(R) | 324808 | Renault Mégane I, Mégane Classic - F Renault Mégane I, Mégane Coach - F |
| 324033 | Subaru Impreza (GD, GG) - F(L) | 324848 | Fiat Tempra (159) - F Fiat Tempra Station Wagon / Familia (159) - F Fiat Tipo (160) - F |
| 324034 | Subaru Impreza (GD, GG) - F(R) | 325001 | Lancia Dedra (835) - F Lancia Delta - F |
| 324035 | Subaru Impreza (GD, GG) - F(L) | 325002 | Toyota RAV 4 - F(R) |
| 324036 | Subaru Impreza (GD, GG) - R(R) | 325700 | Toyota RAV 4 - F(L) Audi A3 (8P1), A3 (8P7) - F Audi A3 Sportback (8PA) - F Audi Q3 - F Seat Alhambra - F Seat Altea, Altea XL - F Seat Leon II - F Seat Toledo III - F Skoda Octavia II - F Skoda Octavia II Combi - F Skoda Superb - F Volkswagen Eos (1F7) - F Volkswagen Golf V - F Volkswagen Golf V Plus - F Volkswagen Golf V Variant - F Volkswagen Golf VI - F Volkswagen Golf VI Variant - F Volkswagen Jetta V - F Volkswagen Jetta VI - F Volkswagen Passat - F Volkswagen Passat (362, 365) - F |
| 324037 | Subaru Impreza (GD, GG) - R(L) | | |
| 324038▼ | Toyota RAV 4 - F(R) | | |
| 324039▼ | Toyota RAV 4 - F(L) | | |
| 324040▼ | Lexus RX - F(R) | | |
| 324041▼ | Lexus RX - F(L) | | |
| 324042 | Lexus RX - R(R) | | |
| 324043 | Lexus RX - R(L) | | |
| 324044 | Toyota Corolla - R(R) | | |
| 324045 | Toyota Corolla - R(L) | | |
| 324046 | Toyota Camry - F(R) | | |
| 324047 | Toyota Camry - F(L) | | |
| 324048 | Toyota Camry - R(R) | | |
| 324049 | Toyota Camry - R(L) | | |
| 324050 | Suzuki Grand Vitara I - F(R) | | |
| 324051 | Suzuki Grand Vitara I - F(L) | | |
| 324052 | Subaru Forester - F(R) | | |
| 324053 | Subaru Forester - F(L) | | |
| 324054 | Subaru Forester - R(R) | | |

| | VEHICLE FAHRZEUG VEHICULE | | VEHICLE FAHRZEUG VEHICULE | |
|--|--|---------------------------------------|--|---|
| 328700 328701 | Volkswagen Passat CC - F Volkswagen Scirocco - F Volkswagen Sharan - F Volkswagen Touran - F Renault Twingo - F(R) Renault Twingo - F(L) | 353013 | Seat Toledo I - R Volkswagen Corrado - R Volkswagen Corrado - R Volkswagen Golf Cabrio - R Volkswagen Golf II, Jetta II - R Volkswagen Golf III, Vento, Jetta III - R Audi A4 (8D2), A4 Avant (8D5) - R Toyota Yaris I - R Audi A4 (8D2), A4 Avant (8D5) - R Seat Ibiza, Cordoba - R Volkswagen Polo, Derby - R | |
| Twin Tube Gas Shock Absorber (35 - Series) | | 353014 353015 353016▼ 353021 | Ford Focus - R Ford Focus - R Toyota Yaris I - R Audi A2 (8Z0) - R Seat Ibiza V - R Seat Ibiza, Cordoba - R Skoda Fabia - R Skoda Fabia III (NJ3, NJ5) - R Volkswagen Polo - R Peugeot 205 - R Peugeot 309 - R Toyota Land Cruiser - R Audi A3 (8P1), A3 (8P7) - R Audi A3 Sportback (8PA) - R Seat Alhambra - R Seat Altea, Altea XL - R Seat Leon II - R Seat Toledo III - R Skoda Octavia II - R Skoda Octavia II Combi - R Skoda Yeti - R Volkswagen Golf Cabrio - R Volkswagen Golf V - R Volkswagen Golf V Plus - R Volkswagen Golf V Variant - R Volkswagen Golf VI - R Volkswagen Golf VI Variant - R Volkswagen Jetta V - R Volkswagen Jetta VI - R Volkswagen Passat - R Volkswagen Passat CC - R Volkswagen Scirocco - R Volkswagen Sharan - R Volkswagen Touran - R | |
| 351004▼ 351007 351008 351009 351010 351011 351012 351013 351014▼ 351018 351019 351020 351021 351025 351027 351028 351029 351030 351031 351700 351701 351702 353010▼ 353011▼ 353012 | Audi 50 - R Volkswagen Polo, Derby - R Volkswagen Golf Cabrio - R Volkswagen Golf I, Jetta I - R Volkswagen Scirocco - R Honda Civic CR-X / Ballade CR-X - F(R) Honda Civic, Ballade - F(R) Honda Civic CR-X / Ballade CR-X - F(L) Honda Civic, Ballade - F(L) Honda Civic Coupé / Ballade Coupé - R Honda Civic CR-X / Ballade CR-X - R Honda Civic, Ballade - R Honda Civic Coupé / Ballade Coupé - F(R) Honda Civic CR-X / Ballade CR-X - F(R) Honda Civic, Ballade - F(R) Honda Civic Coupé / Ballade Coupé - F(L) Honda Civic CR-X / Ballade CR-X - F(L) Honda Civic, Ballade - F(L) Nissan Primera - F Peugeot 405 - R Audi 100, 100 Avant - R Audi A6 (4A), A6 Avant (4A) - R Fiat Cinquecento (170) - R Audi S4 - R Audi S6 - R Lada 110 / 111 / 112 - R Lada Samara, Riva, Diva, Forma, Sagona - R Peugeot 206 - R Peugeot 206 + - R Peugeot 206 - R Peugeot 206 CC - R Peugeot 206 SW - R Nissan Almera (N16) - R Nissan Almera (N16E) - R Mitsubishi Galant, Sapporo (Lambda), Sigma - F Mitsubishi Galant, Sapporo (Lambda), Sigma - R Toyota Land Cruiser - F Audi A4 (8D2), A4 Avant (8D5) - F Toyota Corolla - R Toyota Corolla Verso - R Renault Twingo - R Fiat Uno (146) - R Opel Calibra - R Vauxhall Calibra - R Opel Corsa A, Corsa B - R Opel Tigra - R Vauxhall Nova, Corsa - R Vauxhall Tigra - R | Gas Cartridge (37 - Series) | 373012 373019 374006▼ 374008 | Volkswagen Golf Cabrio - F Volkswagen Golf I, Jetta I - F Volkswagen Scirocco - F BMW 3 Series (E30) - F BMW 3 Series Touring (E30) - F Volkswagen Golf II, Jetta II - F BMW 3 Series (E30) - F BMW 3 Series Touring (E30) - F |

|  | VEHICLE FAHRZEUG VEHICULE |  | VEHICLE FAHRZEUG VEHICULE |
|--|---|---|---------------------------------|
| 375008 | Audi 80, 80 Variant/Avant [91-95] - F Audi 80/90, 80 Variant/Avant [78-91] - F Audi Cabrio (8G) - F Audi Coupé - F Volkswagen Passat, Santana - F | | |
| 375009 | Chevrolet - Daewoo Espero / Aranos - F Chevrolet - Daewoo Lanos / Sens - F Chevrolet - Daewoo Nexia / Cielo - F Opel Kadett, Olympia, Aero - F Vauxhall Astra - F Vauxhall Belmont - F | | |
| 375032 | Opel Calibra - F Opel Vectra A - F Vauxhall Calibra - F Vauxhall Cavalier, Vectra - F | | |
| 375034 | Opel Astra - F Vauxhall Astra - F | | |
| 375035▼ | Toyota RAV 4 - F | | |
| 375036 | Citroën AX - F Citroën Saxo - F Peugeot 106 I, 106 II - F | | |
| 375037 | Lada Samara, Riva, Diva, Forma, Sagona - F | | |
| 375038 | Lada 110 / 111 / 112 - F | | |
| 376001 | Audi 100, 100 Avant - F Audi 200, 200 Avant - F Audi A6 (4A), A6 Avant (4A) - F | | |

| | VEHICLE FAHRZEUG VEHICULE | | VEHICLE FAHRZEUG VEHICULE |
|--|---|--|---|
| Adjustable Twin Tube Gas Strut (73 - Series) | | Adjustable Twin Tube Gas Shock Absorber (74 - Series) | |
| 731003 ▼ 731004 ▼ 733010 733011 733031 ▼ 733032 ▼ 733038 733039 733045 ▼ 733046 ▼ 733047 ▼ 733048 ▼ 734006 734007 734021 734022 734025 ▼ 734026 ▼ 734029 ▼ 734030 ▼ 734033 734034 734035 734036 734037 734039 ▼ 734040 ▼ 734041 ▼ 734042 ▼ 734043 ▼ 734046 ▼ 734047 ▼ 734048 ▼ 734049 ▼ | Honda Civic - F(R) Honda Civic - F(L) Subaru Impreza (GC, GF) - R(R) Subaru Impreza (GC, GF) - R(L) Citroën Xsara (N1/N0) - F(R) Citroën Xsara (N2) - F(R) Citroën ZX - F(R) Peugeot 306 - F(R) Citroën Xsara (N1/N0) - F(L) Citroën Xsara (N2) - F(L) Citroën ZX - F(L) Peugeot 306 - F(L) Toyota Corolla (4.97-9.01) - F(R) Toyota Corolla (4.97-9.01) - F(L) Suzuki Swift III - F(R) Suzuki Swift III - F(L) Toyota Corolla (10.01-) - F(R) Toyota Corolla (10.01-) - F(L) Subaru Impreza (GC, GF) - F(R) Subaru Impreza (GC, GF) - F(L) Toyota Celica - F(R) Toyota Celica - F(L) Toyota Celica - R(R) Toyota Celica - R(L) Peugeot 205 - F(R) Peugeot 205 - F(L) Audi A3 (8L1) - F Seat Leon I - F Seat Toledo II - F Volkswagen Bora , Jetta IV - F Volkswagen Bora Variant - F Volkswagen Golf IV - F Volkswagen Golf IV Variant - F Subaru Impreza (GD, GG) - F(R) Subaru Impreza (GD, GG) - F(L) Subaru Impreza (GD, GG) - R(R) Subaru Impreza (GD, GG) - R(L) Seat Ibiza, Cordoba - F Seat Toledo I - F Volkswagen Corrado - F Volkswagen Golf Cabrio - F Volkswagen Golf II, Jetta II - F Volkswagen Golf III, Vento , Jetta III - F Volkswagen Polo, Derby - F Honda HR-V - F(R) Honda HR-V - F(L) Toyota Corolla (4.97-9.01) - R(R) Toyota Corolla (4.97-11.01) - R(R) Toyota Corolla (4.97-9.01) - R(L) Toyota Corolla (4.97-11.01) - R(L) Toyota Avensis (_T22_) - R(R) Toyota Avensis (_T22_) - R(L) Nissan X-Trail (T30) - F(R) Nissan X-Trail (T30) - F(L) | 741005 741006 741007 741015 741016 741017 ▼ 741023 741024 741033 ▼ 741035 741036 741045 741048 ▼ 741049 ▼ 741055 ▼ 741056 ▼ 741057 ▼ 741060 741062 ▼ 741064 741065 741066 741067 ▼ 741068 741069 741070 ▼ 743029 | Honda Civic Coupé / Ballade Coupé - F(R) Honda Civic CR-X / Ballade CR-X - F(R) Honda Civic, Ballade - F(R) Honda Civic Coupé / Ballade Coupé - F(L) Honda Civic CR-X / Ballade CR-X - F(L) Honda Civic, Ballade - F(L) Honda Civic Coupé / Ballade Coupé - R Honda Civic CR-X / Ballade CR-X - R Honda Civic, Ballade - R Mazda MX-5 - F Mazda MX-5 - R Nissan Silvia, 200 SX - R Honda Civic Coupé / Ballade Coupé - F Honda Civic, Ballade - F Honda Civic Coupé / Ballade Coupé - R Honda Civic, Ballade - R Mitsubishi Colt V - R Mitsubishi FTO - R Mazda MX-5 - F Mazda MX-5 - R Nissan Silvia, 200 SX - R Nissan Primera - F Nissan Primera Traveller - F Honda Accord / Vigor - F Nissan Primera - R Nissan Primera Traveller - R Toyota Celica - R Peugeot 205 - R Honda Civic - R Seat Toledo I - R Volkswagen Corrado - R Volkswagen Golf Cabrio - R Volkswagen Golf II, Jetta II - R Volkswagen Golf III, Vento , Jetta III - R Citroën AX - R Citroën Saxo - R Peugeot 106 I, 106 II - R Honda CR-V - F Honda CR-V - R Ford Focus - R Toyota Land Cruiser - F Peugeot 206 - R Toyota Corolla (1.02-) - R Toyota Corolla (10.01-) - R Toyota Corolla (9.02-) (E12U_) - R Toyota Corolla (E12U_) (11.01-) - R Toyota Corolla Verso - R Audi A3 (8L1) - R Seat Leon I - R Seat Toledo II - R Volkswagen Bora , Jetta IV - R Volkswagen Bora Variant - R Volkswagen Golf IV - R Volkswagen Golf IV Variant - R |

| KYB | VEHICLE FAHRZEUG VEHICULE | KYB | VEHICLE FAHRZEUG VEHICULE |
|--|--|------------|---------------------------------|
| 743034▼ | Citroën Xsara (N1/N0) - R Citroën Xsara (N2) - R Citroën ZX - R Peugeot 306 - R | | |
| 743041▼ | Toyota Land Cruiser - R | | |
| 743042▼ | Honda HR-V - R | | |
| 743044 | Austin-Rover Austin, Morris - F | | |
| 743045 | Austin-Rover Austin, Morris - R(R) | | |
| 743046 | Austin-Rover Austin, Morris - R(L) | | |
| 743048▼ | Suzuki Swift III - R | | |
| Adjustable Twin Tube Gas Cartridge (76 - Series) | | | |
| 765015▼ | Toyota MR 2 - F | | |
| 765016▼ | Toyota MR 2 - R | | |
| 765017 | Toyota Celica - F | | |
| 765020 | Citroën AX - F Citroën Saxo - F Peugeot 106 I, 106 II - F | | |
| 765021▼ | Chevrolet - Daewoo Espero / Aranos - F Chevrolet - Daewoo Nexia / Cielo - F Opel Kadett, Olympia, Aero - F Vauxhall Astra - F | | |

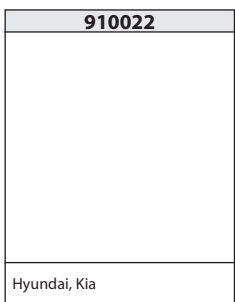
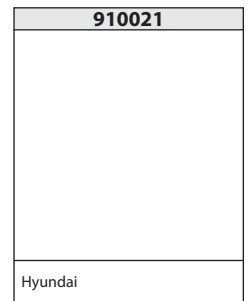
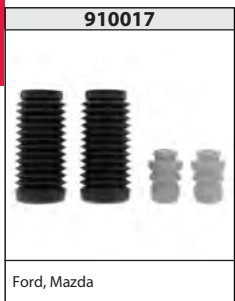







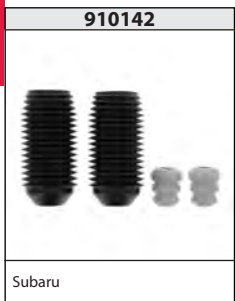

910157

Audi, Skoda

910158

Mercedes Benz

910159

Citroën, Fiat, Peugeot

910160▼

Opel, Vauxhall

910161

Citroën

910162

Saab

910163

Saab

910164

Mitsubishi

910165

Mercedes Benz

910166

Lexus

910167

Mitsubishi, Smart

910168

Toyota

910169

Mini

910170

Ford

910171

Ford

910172

BMW

910173

Hyundai, Kia

910175

Hyundai

910176

Opel, Vauxhall

910177

Skoda, Volkswagen

910178

Honda

910179

Hyundai, Kia

910180

Audi

910181

Alfa Romeo

910182

Alfa Romeo

910183

Audi

910184

Audi

910185

Audi































910186

BMW

910187

BMW



| | | | | |
|--|--|--|---|---|
| <p>910188</p>  <p>BMW</p> | <p>910189</p>  <p>Mini</p> | <p>910190</p>  <p>BMW</p> | <p>910191</p>  <p>Mini</p> | <p>910192</p>  <p>BMW</p> |
| <p>910193</p>  <p>BMW</p> | <p>910194</p>  <p>BMW</p> | <p>910195</p>  <p>BMW</p> | <p>910196</p>  <p>BMW</p> | <p>910197</p>  <p>Citroën</p> |
| <p>910198</p>  <p>Citroën, DS, Peugeot</p> | <p>910199</p>  <p>Nissan, Renault</p> | <p>910200</p>  <p>Alfa Romeo</p> | <p>910201</p>  <p>Fiat</p> | <p>910202</p>  <p>Ford</p> |
| <p>910203</p>  <p>Opel, Vauxhall</p> | <p>910204</p>  <p>Opel, Vauxhall</p> | <p>910205</p>  <p>Chevrolet - Daewoo, Opel, Vauxhall</p> | <p>910206</p>  <p>Opel, Vauxhall</p> | <p>910207</p>  <p>Peugeot</p> |
| <p>910208</p>  <p>Mercedes Benz</p> | <p>910209</p>  <p>Subaru, Toyota</p> | <p>910210</p>  <p>Toyota</p> | <p>910211</p>  <p>Kia</p> | <p>910212</p>  <p>Kia</p> |
| <p>910213</p>  <p>Kia</p> | <p>910214</p>  <p>Hyundai</p> | <p>910215</p>  <p>Hyundai</p> | <p>910216</p>  <p>Volvo</p> | <p>910217</p>  <p>Volvo</p> |

| | | | | |
|--|---|---|---|--|
| <p>910218</p>  <p>BMW</p> | <p>910219</p>  <p>Audi</p> | <p>910220</p>  <p>Seat, Skoda, Volkswagen</p> | <p>910221</p>  <p>Seat, Skoda, Volkswagen</p> | <p>910222</p>  <p>Chevrolet (GM), Chevrolet - Daewoo, Opel, Vauxhall</p> |
| <p>910223</p>  <p>Chevrolet - Daewoo</p> | <p>910224</p>  <p>Audi</p> | <p>910225</p>  <p>Audi</p> | <p>910226</p>  <p>Audi</p> | <p>910227</p>  <p>Audi, Seat</p> |
| <p>910228</p>  <p>Audi</p> | <p>910229</p>  <p>Dacia, Renault</p> | <p>910230</p>  <p>Alfa Romeo</p> | <p>910231</p>  <p>BMW</p> | <p>910232</p>  <p>BMW</p> |
| <p>910233</p>  <p>BMW</p> | <p>910234</p>  <p>BMW</p> | <p>910235</p>  <p>BMW</p> | <p>910236</p>  <p>BMW</p> | <p>910237</p>  <p>BMW</p> |
| <p>910238</p>  <p>BMW</p> | <p>910239</p>  <p>BMW</p> | <p>910240</p>  <p>BMW</p> | <p>910241</p>  <p>BMW</p> | <p>910242</p>  <p>BMW</p> |
| <p>910243</p>  <p>Mini</p> | <p>910244</p>  <p>Renault</p> | <p>910245</p>  <p>Ford</p> | <p>910246</p>  <p>Ford</p> | <p>910247</p>  <p>Seat, Volkswagen</p> |

| 910248 |
|--------|
| |
| Honda |

| 910249 |
|---------|
| |
| Hyundai |

| 910250 |
|--------------|
| |
| Hyundai, Kia |

| 910251 |
|--------|
| |
| Lancia |

| 910252 |
|--------|
| |
| Nissan |

| 910253 |
|--------|
| |
| Smart |

| 910254 |
|--------|
| |
| Toyota |

| 910255 |
|-------------------------------|
| |
| Audi, Seat, Skoda, Volkswagen |

| 910256 |
|--------|
| |
| Audi |

| 910257 |
|--------|
| |
| Audi |

| 910258 |
|--------|
| |
| Audi |

| 910259 |
|----------------------|
| |
| Citroën, DS, Peugeot |

| 910260 |
|------------------|
| |
| Citroën, Peugeot |

| 910261 |
|------------------|
| |
| Citroën, Peugeot |

| 910262 |
|--------|
| |
| Ford |

| 910263 |
|--------|
| |
| Ford |

| 910264 |
|--------|
| |
| Ford |

| 910265 |
|--------|
| |
| Honda |

| 910266 |
|--------|
| |
| Honda |

| 910267 |
|--------|
| |
| Honda |

| 910268 |
|---------|
| |
| Hyundai |

| 910269 |
|--------------|
| |
| Hyundai, Kia |

| 910270 |
|--------------|
| |
| Hyundai, Kia |

| 910271 |
|--------|
| |
| Kia |

| 910272 |
|--------|
| |
| Lancia |

| 910273 |
|--------|
| |
| Mazda |











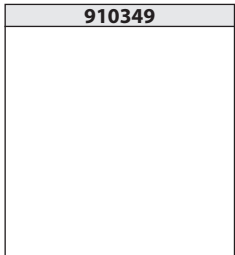
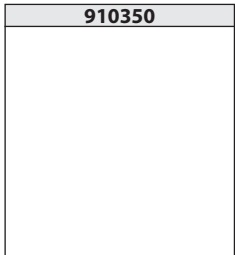
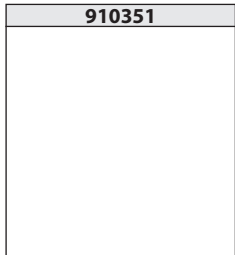
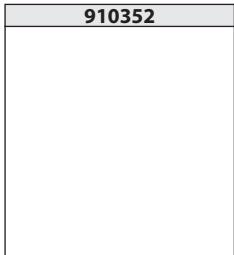
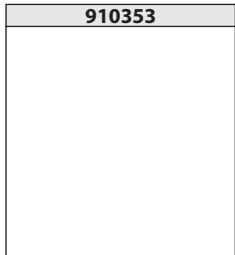
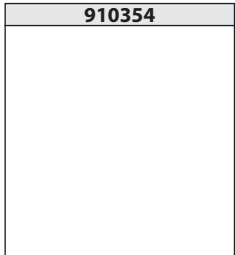
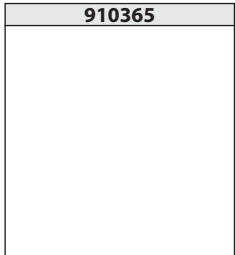





| 910274 |
|---------------|
| |
| Mercedes Benz |

| 910275 |
|---------------|
| |
| Mercedes Benz |

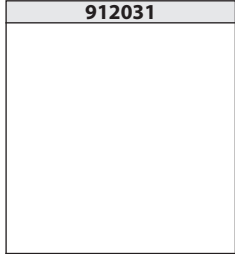
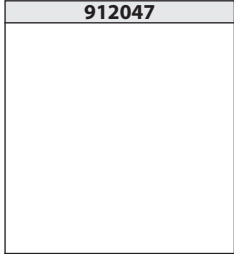
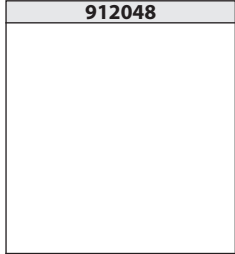
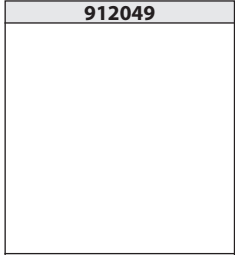
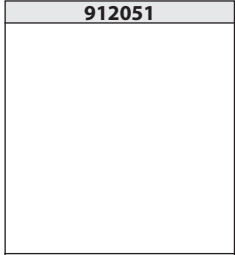
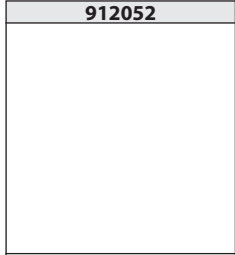
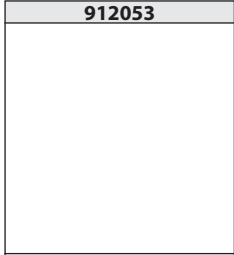
| 910276 |
|----------------|
| |
| Opel, Vauxhall |

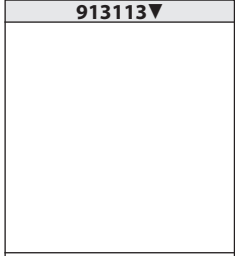
| 910277 |
|----------------|
| |
| Opel, Vauxhall |





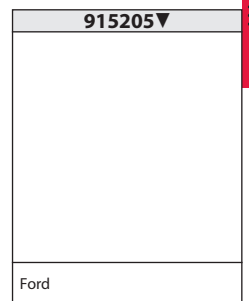
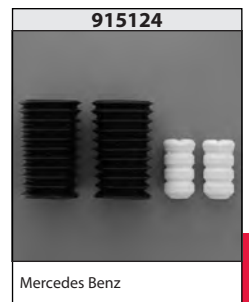
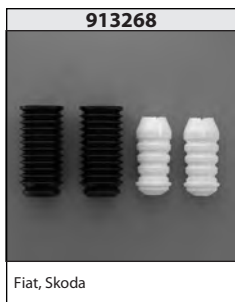
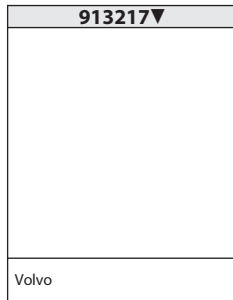
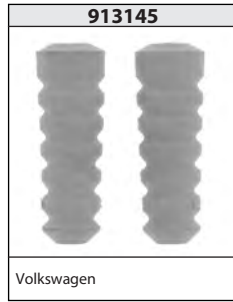

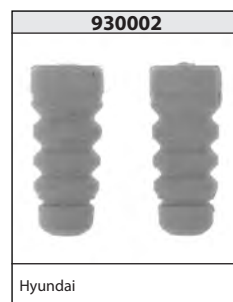
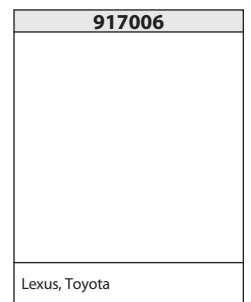
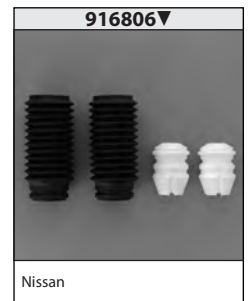
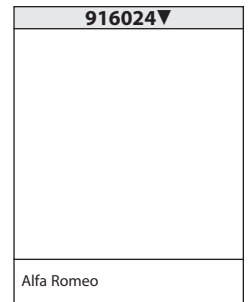
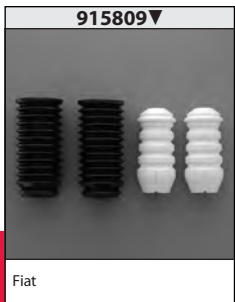
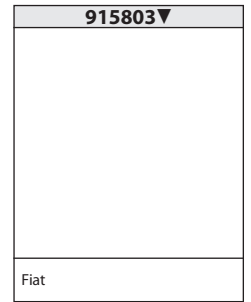
| | | | | |
|--|--|--|--|--|
| <p>910278</p> <p>Opel, Renault, Vauxhall</p> | <p>910279</p> <p>Citroën, Peugeot</p> | <p>910280</p> <p>Seat, Volkswagen</p> | <p>910281</p> <p>Seat, Volkswagen</p> | <p>910282</p> <p>Ford</p> |
| <p>910283</p> <p>Toyota</p> | <p>910284</p> <p>Hyundai, Kia</p> | <p>910285</p> <p>Chevrolet - Daewoo, Opel, Vauxhall</p> | <p>910286</p> <p>Subaru</p> | <p>910287</p> <p>Hyundai, Kia</p> |
| <p>910288</p> <p>Kia</p> | <p>910293</p> <p>Hyundai, Kia</p> | <p>910313</p> <p>Ford</p> | <p>910314</p> <p>Citroën, Peugeot</p> | <p>910316</p> <p>Chevrolet - Daewoo</p> |
| <p>910318</p> <p>Hyundai, Kia</p> | <p>910320</p> <p>Hyundai</p> | <p>910322</p> <p>Land Rover</p> | <p>910323</p> <p>Mitsubishi</p> | <p>910325</p> <p>Mazda</p> |
| <p>910326</p> <p>Land Rover</p> | <p>910327</p> <p>Chevrolet - Daewoo</p> | <p>910328</p> <p>Mitsubishi</p> | <p>910330</p> <p>Mitsubishi</p> | <p>910331</p> <p>Mitsubishi</p> |
| <p>910332</p> <p>Audi, Cupra, Seat, Skoda, Volkswagen</p> | <p>910335</p> <p>Hyundai, Kia</p> | <p>910340</p> <p>Hyundai</p> | <p>910347</p> <p>Honda</p> | <p>910348</p> <p>Mitsubishi</p> |

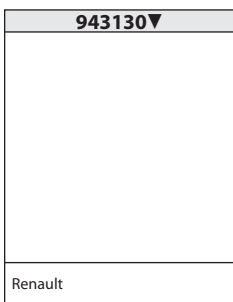
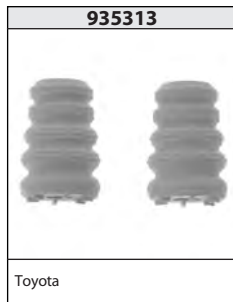
| | | | | |
|--|--|--|---|--|
| <p>910349</p>  <p>Citroën, Mitsubishi, Peugeot</p> | <p>910350</p>  <p>Nissan</p> | <p>910351</p>  <p>Nissan</p> | <p>910352</p>  <p>Nissan</p> | <p>910353</p>  <p>Nissan</p> |
| <p>910354</p>  <p>Nissan</p> | <p>910365</p>  <p>Nissan, Renault</p> | <p>912003▼</p>  <p>Mazda</p> | <p>912020</p>  <p>Nissan, Renault</p> | <p>912022▼</p>  <p>Renault</p> |
| <p>912023</p>  <p>Citroën, Peugeot, Toyota</p> | <p>912024</p>  <p>Renault</p> | <p>912025</p>  <p>Nissan, Renault</p> | <p>912027▼</p>  <p>Opel, Vauxhall</p> | <p>912028</p>  <p>Renault</p> |
| <p>912029</p>  <p>Toyota</p> | <p>912030</p>  <p>Toyota</p> | <p>912031</p>  <p>Nissan</p> | <p>912047</p>  <p>Honda</p> | <p>912048</p>  <p>Chevrolet - Daewoo, Opel, Vauxhall</p> |
| <p>912049</p>  <p>Chevrolet - Daewoo, Opel, Vauxhall</p> | <p>912051</p>  <p>Mitsubishi, Smart</p> | <p>912052</p>  <p>Opel, Suzuki, Vauxhall</p> | <p>912053</p>  <p>Citroën, Mitsubishi, Peugeot</p> | <p>913105</p>  <p>Auto Bianchi, Fiat, Lancia</p> |
| <p>913112</p>  <p>Citroën, Fiat, Mercedes Benz, Peugeot</p> | <p>913113▼</p>  <p>Alfa Romeo, Fiat, Lancia, Peugeot</p> | <p>913116</p>  <p>Fiat, Volvo</p> | <p>913117▼</p>  <p>Volvo</p> | <p>913121</p>  <p>Fiat, Ford, Mazda, Opel, Vauxhall</p> |



















| Protection Kit | | | | Contents | | | |
|----------------|---|---|---|------------|--|---|---|
| |  |  |  | |  |  |  |
| <i>KYB</i> | Bump | Cover | CV and BP | <i>KYB</i> | Bump | Cover | CV and BP |
| 910001 | 2 | 2 | | 910071 | 2 | 2 | |
| 910002 | 2 | 2 | | 910072 | 2 | 2 | |
| 910003 | 2 | 2 | | 910073 | 2 | 2 | |
| 910004 | 2 | 2 | | 910074 | 2 | 2 | |
| 910005 | 2 | 2 | | 910075 | 2 | 2 | |
| 910006 | 2 | 2 | | 910076 | 2 | 2 | |
| 910007 | 2 | 2 | | 910077 | 2 | 2 | |
| 910008 | 2 | 2 | | 910078 | 2 | 2 | |
| 910009 | | | 2 | 910079 | 2 | 2 | |
| 910010 | 2 | 2 | | 910080 | 2 | 2 | |
| 910011 | 2 | 2 | | 910081 | 2 | 2 | |
| 910013 | | | 2 | 910082 | 2 | 2 | |
| 910014 | 2 | 2 | | 910083 | 2 | 2 | |
| 910015 | 2 | 2 | | 910084 | 2 | 2 | |
| 910016 | 2 | 2 | | 910085 | 2 | 2 | |
| 910017 | 2 | 2 | | 910086▼ | 2 | 2 | |
| 910018 | | | 2 | 910087 | 2 | 2 | |
| 910019 | | | 2 | 910088 | 2 | 2 | |
| 910020 | 2 | 2 | | 910089 | 2 | 2 | |
| 910021 | 2 | 2 | | 910090 | 2 | 2 | |
| 910022 | 2 | 2 | | 910091 | 2 | 2 | |
| 910023 | 2 | 2 | | 910092 | 2 | 2 | |
| 910024 | 2 | 2 | | 910093 | 2 | 2 | |
| 910025 | 2 | 2 | | 910095 | 2 | 2 | |
| 910026 | 2 | 2 | | 910096 | 2 | 2 | |
| 910027 | 2 | 2 | | 910097 | 2 | 2 | |
| 910028▼ | | | 2 | 910098 | 2 | 2 | |
| 910029 | | | 2 | 910099 | 2 | 2 | |
| 910031 | | | 2 | 910100 | 2 | 2 | |
| 910032▼ | | | 2 | 910102 | 2 | 2 | |
| 910033 | 2 | 2 | | 910103 | 2 | 2 | |
| 910034▼ | 2 | 2 | | 910104 | 2 | 2 | |
| 910035▼ | | | 2 | 910105 | 2 | 2 | |
| 910036▼ | | | 2 | 910106 | 2 | 2 | |
| 910037 | | | 2 | 910107 | 2 | 2 | |
| 910038▼ | | | 2 | 910108 | 2 | 2 | |
| 910039 | | | 2 | 910109 | 2 | 2 | |
| 910040 | 2 | 2 | | 910110 | 2 | 2 | |
| 910041 | 2 | 2 | | 910111▼ | 2 | 2 | |
| 910042 | | | 2 | 910112 | 2 | 2 | |
| 910043 | | | 2 | 910113 | 2 | 2 | |
| 910044 | 2 | 2 | | 910114 | 2 | 2 | |
| 910045 | 2 | 2 | | 910116 | 2 | 2 | |
| 910046 | 2 | 2 | | 910117 | 2 | 2 | |
| 910047 | 2 | 2 | | 910118 | 2 | 2 | |
| 910048 | 2 | 2 | | 910119 | 2 | 2 | |
| 910049 | 2 | 2 | | 910121 | 2 | 2 | |
| 910050 | 2 | 2 | | 910122 | 2 | 2 | |
| 910051 | 2 | 2 | | 910123 | 2 | 2 | |
| 910052 | | | 2 | 910124 | 2 | 2 | |
| 910053 | 2 | 2 | | 910125 | 2 | 2 | |
| 910054 | 2 | 2 | | 910126 | 2 | 2 | |
| 910055 | 2 | 2 | | 910127 | 2 | 2 | |
| 910056 | 2 | 2 | | 910128 | 2 | 2 | |
| 910057 | 2 | 2 | | 910129 | 2 | 2 | |
| 910058 | 2 | 2 | | 910130 | 2 | 2 | |
| 910059 | 2 | 2 | | 910131 | 2 | 2 | |
| 910060 | | | 2 | 910132 | 2 | 2 | |
| 910061 | 2 | 2 | | 910133 | 2 | 2 | |
| 910062 | 2 | 2 | | 910134 | 2 | 2 | |
| 910063 | 2 | 2 | | 910135 | 2 | 2 | |
| 910064 | 2 | 2 | | 910136 | 2 | 2 | |
| 910065 | 2 | 2 | | 910137 | 2 | 2 | |
| 910066 | 2 | 2 | | 910138▼ | 2 | 2 | |
| 910067 | 2 | 2 | | 910139 | 2 | 2 | |
| 910068 | 2 | 2 | | 910140 | 2 | 2 | |
| 910069 | 2 | 2 | | 910141 | 2 | 2 | |
| 910070 | 2 | 2 | | 910142 | 2 | 2 | |







00000

| Protection Kit | | | | Contents | | | |
|----------------|---|---|---|------------|---|---|---|
| |  |  |  | |  |  |  |
| KYB | Bump | Cover | CV and BP | KYB | Bump | Cover | CV and BP |
| 910143 | 2 | 2 | | 910212 | 2 | 2 | |
| 910144 | 2 | 2 | | 910213 | 2 | 2 | |
| 910145 | 2 | 2 | | 910214 | 2 | 2 | |
| 910146 | 2 | 2 | | 910215 | 2 | 2 | |
| 910147▼ | 2 | 2 | | 910216 | 2 | 2 | |
| 910148 | 2 | 2 | | 910217 | 2 | 2 | |
| 910149 | 2 | 2 | | 910218 | 2 | 2 | |
| 910150 | 2 | 2 | | 910219 | 2 | 2 | |
| 910151 | 2 | 2 | | 910220 | 2 | 2 | |
| 910152 | 2 | 2 | | 910221 | 2 | 2 | |
| 910153 | 2 | 2 | | 910222 | 2 | 2 | |
| 910154 | 2 | 2 | | 910223 | 2 | 2 | |
| 910155 | 2 | 2 | | 910224 | 2 | 2 | |
| 910156 | 2 | 2 | | 910225 | 2 | 2 | |
| 910157 | 2 | 2 | | 910226 | 2 | 2 | |
| 910158 | 2 | 2 | | 910227 | 2 | 2 | |
| 910159 | 2 | 2 | | 910228 | 2 | 2 | |
| 910160▼ | 2 | 2 | | 910229 | 2 | 2 | |
| 910161 | 2 | 2 | | 910230 | 2 | 2 | |
| 910162 | 2 | 2 | | 910231 | 2 | 2 | |
| 910163 | 2 | 2 | | 910232 | 2 | 2 | |
| 910164 | 2 | 2 | | 910233 | 2 | 2 | |
| 910165 | 2 | 2 | | 910234 | 2 | 2 | |
| 910166 | 2 | 2 | | 910235 | 2 | 2 | |
| 910167 | 2 | 2 | | 910236 | 2 | 2 | |
| 910168 | 2 | 2 | | 910237 | 2 | 2 | |
| 910169 | 2 | 2 | | 910238 | 2 | 2 | |
| 910170 | 2 | 2 | | 910239 | 2 | 2 | |
| 910171 | 2 | 2 | | 910240 | 2 | 2 | |
| 910172 | 2 | 2 | | 910241 | 2 | 2 | |
| 910173 | 2 | 2 | | 910242 | 2 | 2 | |
| 910175 | 2 | 2 | | 910243 | 2 | 2 | |
| 910176 | 2 | 2 | | 910244 | 2 | 2 | |
| 910177 | 2 | 2 | | 910245 | 2 | 2 | |
| 910178 | 2 | 2 | | 910246 | 2 | 2 | |
| 910179 | 2 | 2 | | 910247 | 2 | 2 | |
| 910180 | 2 | 2 | | 910248 | 2 | 2 | |
| 910181 | 2 | 2 | | 910249 | 2 | 2 | |
| 910182 | 2 | 2 | | 910250 | 2 | 2 | |
| 910183 | 2 | 2 | | 910251 | 2 | 2 | |
| 910184 | 2 | 2 | | 910252 | 2 | 2 | |
| 910185 | 2 | 2 | | 910253 | 2 | 2 | |
| 910186 | 2 | 2 | | 910254 | 2 | 2 | |
| 910187 | 2 | 2 | | 910255 | 2 | 2 | |
| 910188 | 2 | 2 | | 910256 | 2 | 2 | |
| 910189 | 2 | 2 | | 910257 | 2 | 2 | |
| 910190 | 2 | 2 | | 910258 | 2 | 2 | |
| 910191 | 2 | 2 | | 910259 | 2 | 2 | |
| 910192 | 2 | 2 | | 910260 | 2 | 2 | |
| 910193 | 2 | 2 | | 910261 | 2 | 2 | |
| 910194 | 2 | 2 | | 910262 | 2 | 2 | |
| 910195 | 2 | 2 | | 910263 | 2 | 2 | |
| 910196 | 2 | 2 | | 910264 | 2 | 2 | |
| 910197 | 2 | 2 | | 910265 | 2 | 2 | |
| 910198 | 2 | 2 | | 910266 | 2 | 2 | |
| 910199 | 2 | 2 | | 910267 | 2 | 2 | |
| 910200 | 2 | 2 | | 910268 | 2 | 2 | |
| 910201 | 2 | 2 | | 910269 | 2 | 2 | |
| 910202 | 2 | 2 | | 910270 | 2 | 2 | |
| 910203 | 2 | 2 | | 910271 | 2 | 2 | |
| 910204 | 2 | 2 | | 910272 | 2 | 2 | |
| 910205 | 2 | 2 | | 910273 | 2 | 2 | |
| 910206 | 2 | 2 | | 910274 | 2 | 2 | |
| 910207 | 2 | 2 | | 910275 | 2 | 2 | |
| 910208 | 2 | 2 | | 910276 | 2 | 2 | |
| 910209 | 2 | 2 | | 910277 | 2 | 2 | |
| 910210 | 2 | 2 | | 910278 | 2 | 2 | |
| 910211 | 2 | 2 | | 910279 | 2 | 2 | |



| Protection Kit | | | | Contents | | | |
|----------------|---|---|---|------------|--|---|---|
| |  |  |  | |  |  |  |
| | KYB | | | KYB | | | |
| | Bump | Cover | CV and BP | | Bump | Cover | CV and BP |
| 910280 | 2 | 2 | | 913268 | | | 2 |
| 910281 | 2 | 2 | | 913271 | 2 | 2 | |
| 910282 | 2 | 2 | | 913273 ▼ | 2 | 2 | |
| 910283 | 2 | 2 | | 915002 | 2 | 2 | |
| 910284 | 2 | 2 | | 915124 | 2 | 2 | |
| 910285 | 2 | 2 | | 915200 ▼ | 2 | 2 | |
| 910286 | 2 | 2 | | 915201 | | | 2 |
| 910287 | 2 | 2 | | 915203 ▼ | 2 | 2 | |
| 910288 | 2 | 2 | | 915204 | | | 2 |
| 910293 | 2 | 2 | | 915205 ▼ | 2 | 2 | |
| 910313 | 2 | 2 | | 915208 | 2 | 2 | |
| 910314 | 2 | 2 | | 915209 ▼ | 2 | 2 | |
| 910316 | 2 | 2 | | 915210 ▼ | 2 | 2 | |
| 910318 | 2 | 2 | | 915322 ▼ | 2 | 2 | |
| 910320 | 2 | 2 | | 915329 | 2 | 2 | |
| 910322 | 2 | 2 | | 915400 | 2 | 2 | |
| 910323 | 2 | 2 | | 915401 | 2 | 2 | |
| 910325 | 2 | 2 | | 915404 | 2 | 2 | |
| 910326 | 2 | 2 | | 915408 ▼ | 2 | 2 | |
| 910327 | 2 | 2 | | 915412 | 2 | 2 | |
| 910328 | 2 | 2 | | 915415 | 2 | 2 | |
| 910330 | 2 | 2 | | 915416 | 2 | 2 | |
| 910331 | 2 | 2 | | 915418 | 2 | 2 | |
| 910332 | 2 | 2 | | 915419 | 2 | 2 | |
| 910335 | 2 | 2 | | 915501 | | | 2 |
| 910340 | 2 | 2 | | 915702 ▼ | 2 | 2 | |
| 910347 | 2 | 2 | | 915703 ▼ | 2 | 2 | |
| 910348 | | | 2 | 915705 | | | 2 |
| 910349 | | | 2 | 915708 | 2 | 2 | |
| 910350 | | | 2 | 915803 ▼ | | | 2 |
| 910351 | 2 | 2 | | 915809 ▼ | 2 | 2 | |
| 910352 | | | 2 | 915812 | | | 2 |
| 910353 | | | 2 | 915909 | 2 | 2 | |
| 910354 | | | 2 | 916002 ▼ | 2 | 2 | |
| 910365 | 2 | 2 | | 916024 ▼ | 2 | 2 | |
| 912003 ▼ | | | 2 | 916501 ▼ | 2 | 2 | |
| 912020 | | | 2 | 916502 | 2 | 2 | |
| 912022 ▼ | | | 2 | 916802 ▼ | 2 | 2 | |
| 912023 | | | 2 | 916803 | 2 | 2 | |
| 912024 | | | 2 | 916806 ▼ | 2 | 2 | |
| 912025 | | | 2 | 916902 | 2 | | |
| 912027 ▼ | | | 2 | 917001 | | | 2 |
| 912028 | | | 2 | 917002 ▼ | | 2 | |
| 912029 | | | 2 | 917004 | | 2 | |
| 912030 | | | 2 | 917006 | | 2 | |
| 912031 | | | 2 | 917300 | 2 | 2 | |
| 912047 | | | 2 | 917302 | 2 | 2 | |
| 912048 | | | 2 | 918600 | 2 | 2 | |
| 912049 | | | 2 | 930002 | 2 | | |
| 912051 | | | 2 | 930003 ▼ | 2 | | |
| 912052 | | | 2 | 935301 | 2 | | |
| 912053 | | | 2 | 935302 | 2 | | |
| 913105 | | | 2 | 935303 | 2 | | |
| 913112 | 2 | 2 | | 935304 ▼ | | | 2 |
| 913113 ▼ | 2 | 2 | | 935306 | 2 | | |
| 913116 | 2 | 2 | | 935307 | 2 | | |
| 913117 ▼ | 2 | 2 | | 935308 | 2 | | |
| 913121 | 2 | 2 | | 935309 | 2 | | |
| 913128 ▼ | 2 | 2 | | 935310 | 2 | | |
| 913138 ▼ | 2 | 2 | | 935311 | 2 | | |
| 913145 | 2 | 2 | | 935312 | 2 | | |
| 913147 | 2 | 2 | | 935313 | 2 | | |
| 913151 | | | 2 | 935314 | 2 | | |
| 913212 ▼ | 2 | 2 | | 935315 | 2 | | |
| 913217 ▼ | 2 | 2 | | 940001 | | 2 | |
| 913231 ▼ | 2 | 2 | | 940002 | | | 2 |
| 913237 | | | 2 | 940003 | | 2 | |
| 913267 | 2 | 2 | | 940004 | | 2 | |

00000

| Protection Kit | | | Contents | | | | |
|---|---|---|---|------------|---|---|---|
| |  |  |  | |  |  |  |
| KYB | Bump | Cover | CV and BP | KYB | Bump | Cover | CV and BP |
| 942016 942017 943130▼ 945502 947003 | 2 | | 2 2 2 2 | | | | |



| | | | | | |
|---|--|--|--|--|--|
| <p>MB1504</p>  | <p>Dacia, Lada, Nissan, Renault 5432500QAA 6001025850 6001025925 7700800107 7700800265 8200651172</p> | <p>MB1509</p>  | <p>Nissan, Renault 543250375R 543253RA0A 54325AX000 54325ED00A 54325ED02A 54325JE20B 54325JE20C 54325JE21C 54325JE29E 8200200017 8200948647</p> | <p>MB1901</p>  | <p>Chevrolet - Daewoo, Citroën, DS, Hyundai, Kia, Peugeot, Renault, Volvo 503520 503523 503527 503558 503563 546121G010 546122C000 7700803635 91510633 96261094</p> |
| <p>MB1905</p>  | <p>Citroën, Fiat, Peugeot 503556</p> | <p>MB1907</p>  | <p>Citroën, Fiat, Lancia, Peugeot 1303672080 1318825080 1328825080 1329669080 503538 503543 503545 503555 9405035439 9467562989</p> | <p>MB1909</p>  | <p>Peugeot 503532 503554</p> |
| <p>SM1000</p>  | <p>BMW 31331124508 31331139438 31331139452</p> | <p>SM1001</p>  | <p>BMW 31331090467 31331092885 31331135582 31336764947 31336769585 31336779613</p> | <p>SM1002</p>  | <p>BMW 31331106326 31331110195 31331112644 31332450110</p> |
| <p>SM1003</p>  | <p>BMW 31306767451 31306775098 31331094616 31336752735 31336760943 31336769582 31336770568</p> | <p>SM1004</p>  | <p>BMW 31306782493 31306795083</p> | <p>SM1005</p>  | <p>Hyundai, Kia 5461025100 546102Y000 546102Y100 546102Y500 546123R000 546123W000</p> |
| <p>SM1006</p>  | <p>Mercedes Benz A6393230720 A6399810525</p> | <p>SM1007</p>  | <p>Mercedes Benz A6393230420 A6393230520 A6399810025 A6399810125 A6399810225 A6399810325</p> | <p>SM1008</p>  | <p>Chevrolet (GM), Chevrolet - Daewoo, Opel, Vauxhall 13501413 13505131 13505854 344497 344573 344781 344834 95212727</p> |
| <p>SM1009</p>  | <p>Toyota 4860902160 4860902161 4860902171 9030322002</p> | <p>SM1010</p>  | <p>Toyota 4860905030 4860905040 486090F010 9030322002</p> | <p>SM1011</p>  | <p>Toyota 4860905050 486090F020 486090F021 4861928010 9017810030</p> |

| SM1012 | |
|--------|---|
| | Toyota 486090D040 4861952040 |

| SM1014 | |
|--------|---|
| | Ford 1377259 1381836 1406414 1433283 1441597 1465258 1510474 1539863 1541436 1679526 1734710 1761001 →... |

| SM1014 | |
|--------|---|
| →... | 6G913K099AA 6G913K099ABB 6G913K099ABC 6G913K099NAB 6G913K099NBA 6G913K155AAA 6G913K155AAB 6G913K155AAC 6G913K155AAD 6G915A327NAD AG913K155BAA AG913K155BAB |

| SM1015 | |
|--------|---|
| | Hyundai, Kia 5461107000 5461207000 |

| SM1016 | |
|--------|---|
| | Nissan 543211KA0B 543251KA0A |

| SM1017 | |
|--------|---|
| | Nissan 543201KA0B 543251KA0A |

| SM1018 | |
|--------|--|
| | Nissan, Renault 0122500Q1B 5431000QAA 5432100QOD 5432500QQA 5432500QAA 5433000QOB 5433000QAA 5434800QOD 5434800QAA 543A00300R 6001025850 6001025925 7700426450 →... |

| SM1018 | |
|--------|--|
| →... | 7700800107 7700800265 7700829529 7701472254 7701479059 7703034268 8200053795 8200651172 8200829529 8200867250 8200876298 |

| SM1019 | |
|--------|---|
| | Nissan, Opel, Renault, Vauxhall 4421359 540340004R 5432000QQA 543207065R 8200688783 95507265 |

| SM1020 | |
|--------|---------------------------------------|
| | Chevrolet - Daewoo 96444919 |

| SM1021 | |
|--------|---------------------------------------|
| | Chevrolet - Daewoo 96444920 |

| SM1022 | |
|--------|--|
| | Volvo 30647763 30683637 3546238 35462381 8646713 86467131 9173203 9461728 94617289 |

| SM1023 | |
|--------|--|
| | Peugeot 503523 503527 503558 503563 5038H3 |

| SM1024 | |
|--------|---|
| | Toyota 486090D010 486090D020 486090D090 4860952030 4860952031 |









| SM1025 | |
|--------|-----------------------------|
| | Toyota 4860952050 |

| SM1026 | |
|--------|---------------------------|
| | Jeep 52089331AC |

| SM1027 | |
|--------|---|
| | BMW 31336768674 31336774097 31336775097 |

| SM1028 | |
|--------|---------------------------|
| | BMW 31306785962 |

| | | | | | |
|---|--|---|--|---|--|
| SM1029 Mercedes Benz A2113200126 | | SM1030 Mercedes Benz A2113200226 | | SM1031 ▼ Mercedes Benz A1713200073 | |
| SM1032 Mitsubishi, Smart 4060A081 A4543200103 A4543210435 MR961791 MR961796 MU010343 N910112010001 N913023010002 | | SM1033 BMW 31316771889 31336774738 31336776389 31336776390 31336776391 31336788776 33526862139 | | SM1034 Opel, Vauxhall 4708282 4708287 93193105 93193110 | |
| SM1035 Opel, Vauxhall, Suzuki 11094436 11900440 2066915 2319533 4171080G00 4171080G10 4174183 4174560B00 4701295 4701725 4705260 4707592 →... | | SM1035 →... 9207045 9208611 9209187 9216325 | | SM1036 Opel, Vauxhall 13241767 13293569 13293570 344569 344570 344652 | |
| SM1037 Suzuki 41710M68K00000 4174172J00000 | | SM1039  Chevrolet - Daewoo 94535242 96488050 96945329 | | SM1040 Chrysler - Dodge - Plymouth 4895412AB 4895412AC 4895452AA 6506152AA | |
| SM1041 Alfa Romeo 12646824 50515176 50707110 811900441 | | SM1042 Nissan, Renault 5432000Q0C 543206968R 5432500Q0B 543258271R 54459EN00A 7703602222 | | SM1044 Hyundai, Kia 1338610007K 54610A5000 5461235000 5461235050 | |
| SM1046 Mazda 9YB041032 B45A3438XA BJS73438XA BJS73438XC BJT73438X KD3534380 KD3534380A KD3534380B KD3534380C KD353438X KD353438XA KR273438X | | SM1049 Suzuki 4171068L00 4171157K00 4172079J10 4172080J10 4174257K00 | | SM1050 ▼ Hyundai 546103X100 546103X200 | |

| | | | | | |
|--|--|---|---|--|--|
| <p>SM1051</p> | <p>Audi, Seat, Skoda, Volkswagen 5Q0412249C 5Q0412249E 5Q0412249F 5Q0412331C 5Q0412331D 5Q0412331E 5Q0412331F N10127707 N91021601</p> | <p>SM1052</p> | <p>Honda 51610SMG305 51726SMGE01 51726SMGE02 51920SMGE01 90002510000</p> | <p>SM1053</p> | <p>Mercedes Benz A2049810025 A2463200073 A2463230020 N910143010012</p> |
| <p>SM1054</p> | <p>Chevrolet - Daewoo, Opel, Vauxhall 13502180</p> | <p>SM1055</p> | <p>Citroën, Peugeot 9674550680 9800479780 9800480380 9817592480</p> | <p>SM1056</p> | <p>Mercedes Benz A1683200056 A1683200373 A4143200044</p> |
| <p>SM1061</p> | <p>Citroën, Peugeot 503369 503375 503558 503563 503623 693261 9804776380 9821040880</p> | <p>SM1062</p> | <p>Citroën, DS 5033F9 503558 503563 503623 5038G0 693261</p> | <p>SM1063</p> | <p>Citroën, DS 5033F9 503558 503563 503623 693261 9804776380 9821040880</p> |
| <p>SM1076</p> | <p>Opel, Vauxhall 22744295 22865931 22871864 22880639 23129248 84583352</p> | <p>SM1100</p>  | <p>Mercedes Benz A2013202444</p> | <p>SM1101</p>  | <p>Mercedes Benz A1243201444</p> |
| <p>SM1102</p>  | <p>Mercedes Benz 2033200273</p> | <p>SM1103</p>  | <p>Mercedes Benz 2049810025 2123230020</p> | <p>SM1200</p>  | <p>Ford 6150276 6150277 85BB3K099AA 85BB3K132AA</p> |
| <p>SM1202</p>  | <p>Ford 6112404 6495311 83BB3K099AB 91AB3K155AB</p> | <p>SM1203▼</p>  | <p>Ford 6112404 6150277 83BB3K099AB 85BB3K132AA</p> | <p>SM1204</p>  | <p>Ford, Mazda 1002513 1004019 1010125 1013794 1039001 1055193 1E0034380 1E003438X 96FB3K099AB 96FB3K155AE 96FB3K155AF 96FB3K155AG 98FB3K099AA V97FB3K155AA</p> |

| | | |
|---|--|---|
| <p>SM1205</p>  | <p>Ford 1023332 1051724 1078730 1103725 1793880 6735956 6799585 93BB3K099AB 93BB3K155AC 93BJ3K155AC 97BG3K099AA 98BG3K099AA 98BG3K099AB 98BG3K099AC</p> | |
| <p>SM1206</p>  | <p>Ford 7331751 7350847 95AB3K099AA 95AB3K155AD</p> | |
| <p>SM1207▼</p>  | <p>Ford 6112404 6161336 83BB3K099AB 85GB3K155BA</p> | |
| <p>SM1208</p>  | <p>Ford 6675788 6763456 92VB3K155AC 92VB3K155AD</p> | |
| <p>SM1209</p>  | <p>Ford 1061721 1061722 1087177 1480525 7T163K155AA 98AG3K099AB 98AG3K155AE 98AG3K155AF</p> | |
| <p>SM1210</p>  | <p>Ford, Mazda 1146152 1146153 1151926 1198235 1203103 1253168 1469224 1697347 25613K099AB 25613K099AC 25613K155AB 25613K155AC 25613K155AD →...</p> | |
| <p>SM1210</p> <p>→...</p> <p>25613K155AE 25613K155AF 25613K155AG D3503438XC DD3234380A</p> | <p>SM1211</p>  | <p>Ford 1115177 1117734 1122893 15713K099AD 15713K155AD 15713K155AE 157W3K099AD 157W3K099AE 157W3K155AF 157W3K155AG 157Z18198A 4363242 4386426 4609099 4986166</p> |
| <p>SM1212</p>  | <p>Ford 1023332 1051724 1078730 1103725 4041955 4053300 4070497 4094280 4094373 4706416 5C1118183AA 6735956 →...</p> | |
| <p>SM1212</p> <p>→...</p> <p>93BB3K099AB 97BG3K099AA 98BG3K099AA 98BG3K099AB 98BG3K099AC YC1518183AD YC1518183AE YC1518183AF YC1518183AG YC153K099AA</p> | <p>SM1213▼</p>  | <p>Fiat, Ford 1548182 1553893 1619751 51830518 955118198BA 955118198BB 955118198BC</p> |
| <p>SM1300▼</p>  | <p>Opel, Vauxhall 344508 90184755</p> | |
| <p>SM1301</p>  | <p>Opel, Vauxhall 344514 344515 344516 90236985 90289421 90425479</p> | |
| <p>SM1303</p>  | <p>Opel, Vauxhall 11010091 2080242 344517 344518 344524 344531 90345330 90374844 90496637 90538326</p> | |
| <p>SM1304</p>  | <p>Opel, Vauxhall 344505 344511 90121275 90251358</p> | |
| <p>SM1305</p>  | <p>Opel, Vauxhall 312503 344507 344522 90157569 90170695 90468551</p> | |
| <p>SM1306▼</p>  | <p>Opel 344513 344516 90268464 90425479</p> | |
| <p>SM1307▼</p>  | <p>Chevrolet - Daewoo, Opel, Vauxhall 344509 90184756</p> | |

| SM1310 | |
|--------|--|
| | Opel, Vauxhall 13186959 13186960 13270705 24402155 344503 344543 344544 344565 344625 344665 9191181 93191295 |

| SM1311 | |
|--------|--|
| | Cadillac, Opel, Vauxhall 12793902 13105976 13156294 13178147 13188763 13188764 13270705 2005085 24433051 24435884 24436242 344503 →... |

| SM1311 | |
|--------|--|
| →... | 344529 344530 344533 344536 344537 344538 344625 344665 344987 51755688 51755689 51775397 9191181 9191191 93191295 |

| SM1313 | |
|--------|---|
| | Opel, Vauxhall 312510 344525 90468618 90538936 |

| SM1500 | |
|--------|--|
| | Renault 7700757324 7700777654 7700796766 7700797666 7700824022 7701470087 8671017908 |

| SM1503 | |
|--------|--|
| | Renault 6001025850 7700827436 7701470089 8200651172 |

| SM1504 | |
|--------|--|
| | Renault 6001025850 7700827435 7701470088 8200651172 |

| SM1507▼ | |
|---------|--|
| | Nissan, Renault 5431000QAA 5432500QAA 5433000QAA 543A00300R 6001025850 7700426450 7701472254 7701479059 8200053795 8200651172 8200829529 |

| SM1508▼ | |
|---------|--|
| | Renault 7700757691 7700777654 7700796766 7700797666 7700824022 8671017908 |

| SM1509 | |
|--------|--|
| | Renault 7700777654 7700795187 7700796766 7700797666 7700824022 8671017908 |

| SM1511 | |
|--------|---|
| | Nissan, Opel, Renault, Vauxhall 4408054 4408056 4410926 4417664 4420903 5431000QAB 5432000QAA 5432500QAB 5434800QAB 543A02398R 7701207491 7701209577 →... |

| SM1511 | |
|--------|--|
| →... | 8200010492 8200010493 8200010518 8200619656 8200904007 8200904009 91165309 91166315 93160623 93858805 93862241 |

| SM1512 | |
|--------|--|
| | Renault 7700424481 7700424482 7701207537 8200002876 8200002877 |



















| SM1514 | |
|--------|--|
| | Renault 543A09780R 6000073600 6001025850 7700426450 7701207806 7701479060 7703034268 8200651172 8200876298 |







| SM1515 | |
|--------|--|
| | Renault 7700777654 7700780875 7700796766 7700797666 7700824022 7700835254 7701207797 8671017908 |















| SM1517 | |
|--------|--|
| | Renault 7701207678 7701208891 8200106131 8200222463 8200485734 8200824774 |



















| SM1524 | |
|--------|--|
| | Renault 6025305980 7700803635 7700832420 7703033081 |

| SM1525 | |
|--------|--|
| | Renault 6025305979 7700803635 7700832419 7703033081 |

| | |
|--|--|
| <p>SM1526</p>  | <p>Nissan, Renault 54321AX600 54321BC40A 54325AX000 7701208582 7701208822 8200183567 8200200017 8200504291 8200948647</p> |
| <p>SM1527</p>  | <p>Nissan, Renault 54320AX600 54320BC40A 54325AX000 7701208591 7701208823 8200183568 8200200017 8200504295 8200948647</p> |
| <p>SM1528</p>  | <p>Dacia, Lada, Renault 6001547499 7700426450 8200651172 8200757150 8200876298</p> |
| <p>SM1529</p>  | <p>Renault 7700424482 7701207350 7701208419 8200002877 8200162152 8200201714 8200322166</p> |
| <p>SM1533</p>  | <p>Renault 543200001N 543200002R 543250005R 543251867R 543256557R 543A00001R 543A00002R 543A00003R 543A00004R 543A03826R 543A03846R 543A04089R 543A07290R</p> |
| <p>SM1534</p>  | <p>Renault 543A05333R 7701209840 8200591283 8200948647</p> |
| <p>SM1535</p>  | <p>Renault 540340002R 543250005R 543251867R 543256557R 543A06874R 543A08108R</p> |
| <p>SM1536</p>  | <p>Renault 543020055R 543200001R 543200006R 543200007R 543250005R 543251867R 543256557R 543A00135R 543A03661R 543A05804R 543A08989R</p> |
| <p>SM1545</p>  | <p>Nissan, Renault 543204016R 54320JY00B 54321JY00B 54325ED02A</p> |
| <p>SM1546</p>  | <p>Nissan, Renault 543200919R 54320JY00B 54321JY00B 54325ED02A</p> |
| <p>SM1547</p>  | <p>Mercedes Benz, Volkswagen 2E0407181C 9063230520</p> |
| <p>SM1548</p>  | <p>Mercedes Benz, Smart 2023260076 2023260168 2023260468</p> |
| <p>SM1549</p>  | <p>Mercedes Benz 2023260076 2023260168 2103260468</p> |
| <p>SM1550</p>  | <p>Ford, Mazda 1514857 1526778 1547323 1742604 1845562 1902873 8V513K099AC 8V513K099AD 8V513K099AE 8V513K099AF 8V513K099B2A 8V513K155BA</p> |
| <p>SM1552</p>  | <p>Audi 4F0412377D</p> |
| <p>SM1553</p>  | <p>Citroën, DS, Peugeot 5031F2 503369 503375 503527 5038G6 5038H4</p> |
| <p>SM1554</p>  | <p>Renault 543024644R 543259539R 543A02310R</p> |
| <p>SM1700</p>  | <p>Seat, Volkswagen 357412329</p> |

| | | | |
|--|---|--|--|
| <p>SM1701▼</p> <p>Seat, Volkswagen 191412329</p> |  | <p>SM1702</p> <p>Audi, Volkswagen 8A0412323D</p> | <p>SM1703</p> <p>Audi, Volkswagen 861412323A 871412323A 871412323B</p> |
| <p>SM1704</p> <p>Ford, Seat, Volkswagen 1102592 1J0412249 357412331A 7201848 7M0412331 95VW3K031AA 95VW3K099AB</p> |  | <p>SM1705</p> <p>Seat SE021156017A SE021156228A</p> | <p>SM1707</p> <p>Seat, Volkswagen 1J0412249 6N0412331A</p> |
| <p>SM1708</p> <p>Audi, Seat, Skoda, Volkswagen 1J0412249 1J0412331B 1J0412331C 6R0412249</p> |  | <p>SM1710▼</p> <p>Audi 441412249A 443412377</p> | <p>SM1711▼</p> <p>Audi, Volkswagen 4D0412377D 4D0412377F 8D0412065</p> |
| <p>SM1712▼</p> <p>Audi, Volkswagen 4D0412377D 4D0412377F 8D0412065G</p> |  | <p>SM1713</p> <p>Audi, Seat, Skoda, Volkswagen 1K0412249B 6N0412249B 6N0412249C 6N0412249D 6N0412331D 6N0412331E 6Q0412331B 8Z0412331</p> | <p>SM1714</p> <p>Audi, Seat, Skoda, Volkswagen 1K0412249B 1K0412331B 1K0412331C 6N0412249B 6N0412249C 6N0412249D 8J0412331</p> |
| <p>SM1715</p> <p>Volkswagen 7E0412249 7E0412249A 7E0412249B 7E0412331 7E0412331A 7H0412249A</p> |  | <p>SM1800▼</p> <p>Fiat 4400895 50003871 5968311</p> | <p>SM1802▼</p> <p>Fiat, Lancia 11733534 12642021 14496821 46414184 60806398 60809753 60811372 7601502 7683361 7683363</p> |
| <p>SM1803▼</p> <p>Fiat, Lancia 11733534 12642021 14496821 46414183 60806398 60809752 60811373 7601502 7683364 7714789</p> |  | <p>SM1804</p> <p>Fiat, Seat 4400895 4400899</p> | <p>SM1805</p> <p>Fiat, Lancia 46452740 7775940</p> |

| | | | | | |
|---|---|---|--|---|--|
| <p>SM1806</p>  | <p>Fiat 14496821 46445246 46469709 7776485</p> | <p>SM1807▼</p>  | <p>Fiat, Lancia 82398815 82406928</p> | <p>SM1810</p>  | <p>Fiat 46746544</p> |
| <p>SM1811</p>  | <p>Fiat, Ford, Lancia 1548182 1553893 1619751 46746546 50702204 50702206 50703155 50704320 50706933 51830518 51856856 51876262 955118198BA 955118198BB 955118198BC</p> | <p>SM1812▼</p>  | <p>Fiat 46746548 51856857</p> | <p>SM1813</p>  | <p>Fiat 14496821 7667087 FIATRDL003</p> |
| <p>SM1814</p>  | <p>Fiat 46457409 46760673 82491440</p> | <p>SM1815</p>  | <p>Fiat 46457410 46760674 82491441</p> | <p>SM1816</p>  | <p>Fiat, Lancia 50700871 50700886 50702841</p> |
| <p>SM1819</p>  | <p>Fiat 1303672080 46536244</p> | <p>SM1820</p>  | <p>Alfa Romeo, Chrysler, Fiat, Lancia, Opel, Vauxhall 13241765 13241767 344652 344653 344962 50510134 50517346 50521707 51780079 51780702 51813225 →...</p> | <p>SM1820</p> <p>→...</p> <p>51831016 51892267 52027765 55702312 55702313 55703313</p> | |
| <p>SM1821</p>  | <p>Citroën, Fiat, Opel, Peugeot, Vauxhall 15503811 1609247480 1609274780 1611313980 1611405980 344811 344896 345070 345174 5038G2 5038G8 5038J7 →...</p> | <p>SM1821</p> <p>→...</p> <p>508918 51794799 51804747 51839975 51890881 51928747 51963725 52023096 95511352 95514538 95516717 95521001</p> | <p>SM1822</p>  | <p>Citroën, Fiat, Opel, Peugeot, Vauxhall 15503811 1609274680 1611313780 1611405980 344812 344897 345071 345173 5037G7 5038G3 5038J8 51794798 →...</p> | |
| <p>SM1822</p> <p>→...</p> <p>51804748 51839931 51890880 51928745 51963726 52023098 95511353 95514539 95516718 95521000</p> | | <p>SM1851</p>  | <p>Lancia 1303672080 46544151</p> | <p>SM1900</p>  | <p>Citroën, Peugeot 503125 503155 503527 503733</p> |

| | | | | | |
|---|--|--|--|--|---|
| <p>SM1901</p>  | <p>Peugeot 503163 503521 503527 503720</p> | <p>SM1902</p>  | <p>Citroën, Peugeot 503154 503527 503852</p> | <p>SM1903</p>  | <p>Citroën, Peugeot 503153 503527 503850</p> |
| <p>SM1904▼</p>  | <p>Peugeot 503164 503527 503726</p> | <p>SM1905</p>  | <p>Citroën, Peugeot 503172 503527 503876</p> | <p>SM1906</p>  | <p>Citroën, Peugeot 503173 503181 503182 503527 503878 503893</p> |
| <p>SM1907</p>  | <p>Peugeot 503161 503527 503864</p> | <p>SM1909▼</p>  | <p>Peugeot 503527 521022</p> | <p>SM1910</p>  | <p>Peugeot 503156 5031A2 503527 503854 5038C5</p> |
| <p>SM1911</p>  | <p>Peugeot 503158 5031A1 503527 503858 5038C6</p> | <p>SM1912</p>  | <p>Peugeot 503157 503527 503856</p> | <p>SM1913</p>  | <p>Peugeot 503159 503527 503860</p> |
| <p>SM1914▼</p>  | <p>Peugeot 503162 503518 503527</p> | <p>SM1915</p>  | <p>Peugeot 503165 503532 503554 503866</p> | <p>SM1916</p>  | <p>Citroën, Fiat, Lancia, Peugeot 1303672080 1311931080 503166 503168 5031A8 503543 503555 5038E9 503868 9405038689 9467562689 9467562789 9467562989</p> |
| <p>SM1917</p>  | <p>Citroën, Fiat, Lancia, Peugeot 1303672080 1311931080 503167 503169 5031A9 503543 503555 503870 9405038709 9467562589 9467562889 9467562989</p> | <p>SM1920</p>  | <p>Citroën, Fiat, Peugeot 1307241080 1318573080 1323165080 1342879080 1355179080 1620298580 503171 503547 503818 503841 503872 503874</p> | <p>SM1921</p>  | <p>Citroën, Fiat, Peugeot 1307242080 1318573080 1323166080 1342879080 1355179080 1620298580 503170 503547 503819 503842 503872 503874</p> |

| SM1922 | |
|--------|----------------|
| | Citroën |
| | 503180 |
| | 503369 |
| | 503375 |
| | 503527 |
| 503891 | |

| SM1923 | |
|--------|-------------------------|
| | Citroën, Peugeot |
| | 503177 |
| | 5031E9 |
| | 503369 |
| | 503375 |
| | 503527 |
| | 503558 |
| | 503563 |
| | 503623 |
| | 5038F7 |
| | 5038G0 |
| | 693261 |

| SM1926 | |
|--------|-------------------------------|
| | Citroën, Fiat, Peugeot |
| | 1318572080 |
| | 1318573080 |
| | 1320987080 |
| | 1329774080 |
| | 1338762080 |
| | 1339629080 |
| | 1342879080 |
| | 1345897080 |
| | 1350789080 |
| | 1355179080 |
| | 1357705080 |
| | 1607691280 |
| | →... |

| SM1926 | |
|------------|--|
| →... | |
| 1610531680 | |
| 1620298580 | |
| 503178 | |
| 5031F4 | |
| 503547 | |
| 503550 | |
| 503555 | |
| 5038000 | |
| 5038E9 | |
| 503829 | |
| 503868 | |
| 5038F3 | |
| 9405031789 | |

| SM1927 | |
|--------|-------------------------------|
| | Citroën, Fiat, Peugeot |
| | 1318571080 |
| | 1318573080 |
| | 1320987080 |
| | 1329775080 |
| | 1338761080 |
| | 1339628080 |
| | 1342879080 |
| | 1345896080 |
| | 1350788080 |
| | 1355179080 |
| | 1357704080 |
| | 1620298580 |
| | →... |

| SM1927 | |
|------------|--|
| →... | |
| 503179 | |
| 5031F5 | |
| 503547 | |
| 503550 | |
| 503555 | |
| 503800 | |
| 503800 | |
| 503828 | |
| 503870 | |
| 5038F4 | |
| 9405031799 | |

| SM1929 | |
|--------|-------------------------|
| | Citroën, Peugeot |
| | 5038A6 |
| | 5038E6 |
| | 5038G1 |

| SM1930 | |
|--------|---------------------------------|
| | Citroën, Peugeot, Toyota |
| | 486090H010 |
| | 486090H020 |
| | 486190H010 |
| | 5031C2 |
| | 503557 |
| | 5038F6 |
| | 8000771680 |

| SM1931 | |
|--------|-------------------------|
| | Citroën, Peugeot |
| | 503196 |
| | 503369 |
| | 503375 |
| | 5038F5 |

| SM1932 | |
|--------|----------------|
| | Peugeot |
| | 5031A3 |
| | 503527 |
| | 5038E7 |

| SM1933 | |
|--------|-----------------------------|
| | Citroën, DS, Peugeot |
| | 5031F0 |
| | 503527 |
| | 503563 |
| | 5038G4 |
| | 9813916080 |

| SM2005 | |
|--------|-------------------|
| | Alfa Romeo |
| | 60625002 |

| SM2302 | |
|--------|-----------------------|
| | Opel, Vauxhall |
| | 312503 |
| | 344519 |
| | 90170695 |
| | 90445207 |

| SM2803 | |
|--------|---------------|
| | Nissan |
| | 54320JD00B |
| | 54325ED02A |
| | 54325JE20C |
| | 54325JE21C |

| SM2804 | |
|--------|---------------|
| | Nissan |
| | 54321JD00B |
| | 54325ED02A |
| | 54325JE20C |
| | 54325JE21C |

| SM2805 | |
|--------|---------------|
| | Nissan |
| | 543219U00A |
| | 543219U01A |
| | 54325AX000 |
| | 54325ED02A |

| SM2806 | |
|--------|---------------|
| | Nissan |
| | 0122300Q0A |
| | 0122300Q0M |
| | 543209U01A |
| | 54325AX000 |
| | 54325ED02A |

| SM2807 | |
|--------|---------------|
| | Nissan |
| | 543201F500 |
| | 543204F102 |
| | 5432541B01 |

SM3200



Lada
21082902820
21082902840

SM3201▼



Lada
21082902840
21102902828

SM3302▼



Mitsubishi
54610M2000
MB573617

SM3703



Suzuki
4171051K00
4171057K10
4171062J10
4171063J11
4174158J00
4174162J00
4174257K00

SM5003



Chrysler
4322615
4322620
4322760
4404976
4404977
4684005
4684006
4684643
4684678

SM5019▼



Toyota
4860912151
4860920059
4860920060
94843668
94845314

SM5046



Mazda
B455280A3
B45528390C
B45528390D
B45528390E
B59528390
EA0128390
F1CZ18197A
F7CZ18197AA
F7CZ18197BA
FOCZ18197A

SM5048



Nissan
5432050A00
5432101A01

SM5049



Toyota
4860901040
4860902070
4860912190
4860912191
4860912192
4860912330
4860932040
4860932080
94849261
94849262
94854736
94857922

SM5050



Volvo
1272455
12724555

SM5058



Honda, Mazda, Rover
51621584A01
516215D4004
516215R0003
516315B0003
516315B0004
516315H0003
516315L0003
516315S0004
516315V7004
516855H3014
516855R0004
517285R0003
52621634000
→...

SM5058

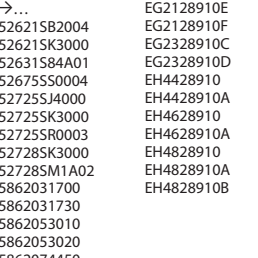

→...
EG2128910E
EG2128910F
EG2328910C
EG2328910D
EH4428910
EH4428910A
EH4628910
EH4628910A
EH4628910A
EH4828910
EH4828910A
EH4828910B

526215B2004
526215K3000
52631584A01
526755S0004
527255J4000
527255K3000
527255R0003
527285K3000
527285M1A02
5862031700
5862031730
5862053010
5862053020
5862074450

SM5059



Honda, Rover
51621584A01
516855R0004
516855R0A01
517285R0003
519235B2004
526215B2000
526215B2003
526215B2004
52631672014
52631692014
526315B0014
526315F0004
526315V7004
→...

SM5059

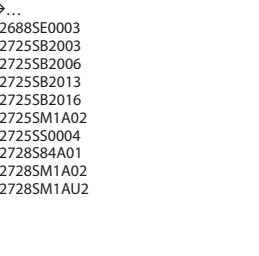

→...
526885E0003
527255B2003
527255B2006
527255B2013
527255B2016
527255M1A02
527255S0004
527285B4A01
527285M1A02
527285M1AU2

SM5060▼



Hyundai
5461023000
5461023001
5461024000
5461024001
MB109960

SM5063



Hyundai, Mitsubishi
5461028000
MB518798

SM5067▼



Toyota
4860916040

SM5069



Toyota
4875012020
4875012040
4875016020
4875020010
4875020040
4875032010
94840591
94845321

| | |
|--|---|
| <p>SM5072</p>  | <p>Mitsubishi MB518141</p> |
| <p>SM5074</p>  | <p>Toyota 4807202040 4807202041 4807212130 4807212140</p> |
| <p>SM5075</p>  | <p>Toyota 4807102040 4807102041 4807112130 4807112140</p> |
| <p>SM5077</p>  | <p>Mazda NA0128380 NA0128380A NA0128380B</p> |
| <p>SM5082</p>  | <p>Suzuki 30005938 4161060A00 4181060A01 4181077</p> |
| <p>SM5085▼</p>  | <p>Nissan 5532050Y10 5532050Y12</p> |
| <p>SM5086</p>  | <p>Toyota 4860920090 4860920100 4860920240</p> |
| <p>SM5087</p>  | <p>Toyota 4807120080 4807120140 4807120141 4807120151 4807220020 4807220040 4807220041 4807220061 4875005020 4875005030 4875020050 4875021020</p> |
| <p>SM5088</p>  | <p>Toyota 4875016040 4875016070 4875016080</p> |
| <p>SM5089</p>  | <p>Toyota 4860910090 4860910130 4860910160 4860916130 4860916140 4860916160 4860916220 4860916230 4860916260 4860916280</p> |
| <p>SM5090</p>  | <p>Toyota 4860928010 4860932030</p> |
| <p>SM5091</p>  | <p>Chrysler, Citroën, Hyundai, Kia, Mitsubishi, Peugeot, Volvo 30870290 30870376 30870698 30874887 4626919 4695030 4695671 5464238000 5533528000 5533628000 →...</p> |
| <p>SM5091</p> <p>→... MB910802 5533738000 MB910887 5533738010 MR223332 5534238000 MR223333 5534338001 MR235627 5534338001 MR235627 5534338001 MR235628 5534538000 MR491950 9076A001 MR554369 MB242358 MR554370 MB242360 MR554373 MB338618 MR594612 MB338620 MR594613 MB515578 MB515579 MB871748</p> | |
| <p>SM5092</p>  | <p>Volvo 1273746 13871884 3530341</p> |
| <p>SM5093▼</p>  | <p>Ford (US), Mazda F32Z18192B F32Z18192D GA2A28390A GD7A28390</p> |
| <p>SM5094▼</p>  | <p>Ford (US), Mazda F32Z18192A F32Z18192C GA2A28380A GD7A28380</p> |
| <p>SM5095▼</p>  | <p>Mitsubishi MB175980</p> |
| <p>SM5101</p>  | <p>Nissan 5432035F00</p> |

SM5103▼



Saab
32015429
4106969
8963282

SM5104



Toyota
4860902040
4860912210
4860912211
4860912231
4860912270
4860912340
4860912341
4860912370

SM5108



Suzuki
4171282000
4171382000
4171482000
4173182000
96052206
96055786

SM5109▼



Mitsubishi
MB808306

SM5112



Chrysler
4684129
4684418
4694870
4694870AB
4694870AC
4694870AD

SM5122



Nissan
5432040U00
5432040U02
5432040U10
543250W000
5432531U01
543255V000

SM5123



Nissan
562170M800
5621733P00
5621739U00
5621761L10
5621771L00
5621790J00
5621801U00
562180M800
5621835F00
5621861L10
5621890J00

SM5126



Toyota
4851006010
4851033010
4852006010
4852033010
4860906010
4860933011
4860933051
4860933090

SM5133▼



Toyota
4875006010
4875032070
4876006010
4876032020

SM5135▼



Chrysler - Dodge - Plymouth
4626182

SM5137



Chrysler - Dodge - Plymouth
4616703

SM5139



Mazda
F4BZ18A179B
F4BZ18A179C
MD10728776
MD10728776
NC1028340
NC1028340B
NC1028340C
NC1028774
NC1028775
NC1028776
NC1028777

SM5143



Opel, Vauxhall
312119
22130008
22173123
22175165
22179011
22179331
25875709
312296
312511
312512
312513
344526
908554

SM5148



Hyundai
4869387703
5531122000

SM5149



Hyundai
5461022000
5461122000

SM5150



Mazda
B01C34380
EBBZ3B455A

SM5151



Kia
0K52Y34380
LB8234380
Q0K52Y34380Q

SM5152



Mitsubishi
MR297932
MR316457
MR455018

| | |
|---|---|
| <p>SM5153</p>  | <p>Nissan 5432050Y12 5432916A00 5532050Y10 5532050Y11</p> |
| <p>SM5161</p>  | <p>Toyota 4860917030 4860917040</p> |
| <p>SM5162</p>  | <p>Toyota 4860942010 4860942011 4860942012</p> |
| <p>SM5163</p>  | <p>Toyota 4875016100 4875016110</p> |
| <p>SM5164</p>  | <p>Toyota 4860920401 9090363002</p> |
| <p>SM5165</p>  | <p>Volvo 31200599 3546189 35461896</p> |
| <p>SM5174▼</p>  | <p>Toyota 4860907010 9090363002</p> |
| <p>SM5175</p>  | <p>Lexus, Toyota 4875006050 4875006051 4875006060 4875006061 4875006062 4875007010 4875007011 4875033020 4875033061 4875033071 4875048010 4875048030 4876006030 →...</p> |
| <p>SM5175</p> <p>→...</p> <p>4876006050 4876006051 4876006060 4876006061 4876006062 4876007010 4876007011 4876033020 4876033061 4876033071 4876048010 4876048030</p> | |
| <p>SM5179▼</p>  | <p>Toyota 4860306010 4860306011 4860306031 4860308010 4860333010 4860333020 4860333021 9090363002</p> |
| <p>SM5180▼</p>  | <p>Toyota 4860906060 4860906061 4860906081 4860908010 4860933110 4860933120 4860933121 9090363002</p> |
| <p>SM5183▼</p>  | <p>Audi 4A0412249 4A0412377A 4A0412377B 4A0412377C</p> |
| <p>SM5186▼</p>  | <p>Toyota 4875014041 4875014050 4875024072</p> |
| <p>SM5188</p>  | <p>Suzuki 4171050G00 4171060B00 4174160B00 4174250G00 88946325 91171892 91174204 96060516 96060519</p> |
| <p>SM5189</p>  | <p>Suzuki 4191050G00 4191060B02 4191060 4191070C00 91171891 96066526 96067379 96067954</p> |
| <p>SM5193</p>  | <p>Hyundai 516102D100 5461029000 546102D000 546102D100 546102F000</p> |
| <p>SM5194</p>  | <p>Hyundai 5461034000 5461034010 MB633021</p> |
| <p>SM5195</p>  | <p>Hyundai, Mitsubishi 5461036002 54610M200 MB573617</p> |

| | | |
|---------------|---|---|
| SM5197 |  | Volkswagen 191512119 321512117 321512333 333512143A 357512333C 357512335B 823512097 |
|---------------|---|---|

| | | |
|---------------|---|--|
| SM5198 |  | Chrysler - Dodge - Plymouth 4656264AB 4656264AC 4656265AB 4656265AC |
|---------------|---|--|

| | | |
|---------------|---|--|
| SM5199 |  | Chrysler - Dodge - Plymouth 5272226 5272227 |
|---------------|---|--|

| | | |
|---------------|---|------------------------------|
| SM5200 |  | Hyundai 5533038101 |
|---------------|---|------------------------------|

| | | |
|---------------|---|------------------------------|
| SM5201 |  | Hyundai 5461025000 |
|---------------|---|------------------------------|

| | | |
|---------------|---|---|
| SM5204 |  | Nissan 5532063J00 5532063J10 |
|---------------|---|---|

| | | |
|---------------|--|--|
| SM5205 |  | Lexus 4860924040 4860930020 4860930050 |
|---------------|--|--|

| | | |
|---------------|--|---|
| SM5206 |  | Ford Y54Z18159AA Y54Z18A161AAA Y54Z18A161DAA Y54Z5K570AA |
|---------------|--|---|

| | | |
|---------------|--|---|
| SM5214 |  | Subaru 20370AE00A 20370AG00A 20375AE00A |
|---------------|--|---|

| | | |
|---------------|---|---|
| SM5215 |  | Toyota 4860901050 4860902120 4860912530 4860913010 4860917050 4860917051 4860920470 4860920471 88970151 |
|---------------|---|---|

| | | |
|---------------|---|---|
| SM5216 |  | Nissan 543204M401 543204M800 543204Z000 543204Z020 543204Z200 543204Z700 543204Z710 5432095F0A 54320BM40A 543254Z000 543256M000 5432595F0A |
|---------------|---|---|

| | | |
|---------------|---|---|
| SM5217 |  | Nissan 553202Y020 553202Y600 553203Y000 |
|---------------|---|---|

| | | |
|---------------|---|---|
| SM5220 |  | Volvo 3516151 9140847 9461524 |
|---------------|---|---|

| | | |
|---------------|---|---|
| SM5232 |  | Kia 0K20128380A K20128380A |
|---------------|---|---|

| | | |
|---------------|---|---|
| SM5233 |  | Kia 0K20128390A K20128390A |
|---------------|---|---|

| | | |
|---------------|---|---------------------------|
| SM5234 |  | Kia 0K20134390B |
|---------------|---|---------------------------|

| | | |
|---------------|---|---|
| SM5236 |  | Audi, Volkswagen 4D0412377D 4D0412377F |
|---------------|---|---|

| | | |
|---------------|---|---|
| SM5239 |  | Hyundai, Kia 553101F000 5531029000 553102D000 553102E000 |
|---------------|---|---|

| | | | | | |
|---|--|---|---|---|--|
| <p>SM5240</p>  | <p>Hyundai, Kia 553201F000 5532029000 553202D000 553202E000</p> | <p>SM5243</p>  | <p>Subaru 20370AA200 20370FA200</p> | <p>SM5246▼</p>  | <p>Subaru 20370AC220</p> |
| <p>SM5247▼</p>  | <p>Subaru 20370AC230</p> | <p>SM5251</p>  | <p>BMW 33521091710</p> | <p>SM5252</p>  | <p>BMW 31331090611</p> |
| <p>SM5254</p>  | <p>BMW 31306779604 31331090612 31331096311 31336769584</p> | <p>SM5262</p>  | <p>Chrysler - Dodge - Plymouth 4616564 4616934 4626919 4695030 4695671 4764221</p> | <p>SM5263</p>  | <p>Chrysler - Dodge - Plymouth 4616934 4626919 4695030 4695769 4764483AA</p> |
| <p>SM5266</p>  | <p>Chrysler - Dodge - Plymouth 4743044AA 4766116AA 4766116AB</p> | <p>SM5291▼</p>  | <p>Honda 526755F1004 526865F1004 526875F1004</p> | <p>SM5294▼</p>  | <p>Hyundai 5534236010 5534336010</p> |
| <p>SM5295</p>  | <p>Hyundai, Kia 5461026000 546102E000 546102E100 546102E200 5461037100 546103A000 546103A100 546103A200 5462037110 MB554246</p> | <p>SM5296</p>  | <p>Hyundai 5531026000 5531526000 5532026000 5532526500 5534126000</p> | <p>SM5300▼</p>  | <p>Mazda B4553438XA E92Z18198GA E92Z18A161B E92Z18A161BA F02Z18198DA F02Z18198FA F02Z18A161B F12Z18A161C GJ2334380B GN8234380 H2663438X LC623438X</p> |
| <p>SM5305</p>  | <p>Mazda B45534380B B45534380C B45534380D B4553438XA FOCZ18A161A FOCZ18A161AA F8CZ18A161AA F8CZ18A161AAA</p> | <p>SM5307▼</p>  | <p>Mazda G03034390E G11534381C</p> | <p>SM5308</p>  | <p>Ford (US), Kia, Mazda 0K2A134380A 0K2A13438XA F32Z18198BA F32Z18A161AA F32Z18A161BA GA2A34380 GA2A3438XA GA5R34380</p> |

SM5311



Mitsubishi
MR130519
MR131420

SM5314



Mitsubishi
MR353211
MR374546
MR374547
MR455493

SM5316▼



Mitsubishi
MB303065
MB303066
MB303072
MB518268

SM5317▼



Mitsubishi
MB303065
MB303072
MB430357

SM5318▼



Mitsubishi
MB303065
MB303072
MB430356

SM5322▼



Nissan
5432005E00
543250B000
5432521000
543257B000

SM5325▼



Nissan
55325D0100
55326D0100

SM5327▼



Nissan
543205A00
5432101A01
5432901A01
5432916A00

SM5336



Saab
4246377
4565149
4909701
5057625
5061007
5233366
5239843

SM5340



Saab
4246377
4908562
4909701
5060892

SM5361



Subaru
20320AA100
20320AA110
20320AA111
20320AJ00A
32005841
32005842

SM5362▼



Subaru
21029GA030
21029GA050
21042GA810
21064GA130

SM5364▼



Subaru
21033GA040
21033GA140

SM5366



Suzuki
4181065D10
4181065D11
4181065DB0
91174728

SM5375▼



Toyota
4875032040

SM5377



Audi, Volkswagen
191512119
321512117
321512333
321512335
357512333
357512333C
357512335B
823512097
8D0512097
8D0512115
8D0512333
8D0512335
N90113701

SM5379



Skoda, Volkswagen
380513353

SM5380



Skoda, Volkswagen
387412377
387412377A
4D0412369A

| SM5382 | |
|--------|---|
| | Toyota 4875001020 4875002040 4875002050 4875021060 4875032170 4875047010 4875501020 4875502040 4875502050 4875520010 4875563010 88971273 88971274 →... |

| SM5382 | |
|--------|--|
| →... | 88971276 88971280 88971281 88972774 88974640 9094803021 |

| SM5386 | |
|--------|---------------------------|
| | Jeep 52128532AA |

| SM5387 | |
|--------|---------------------------|
| | Jeep 52128533AA |

| SM5400 | |
|--------|---|
| | Honda 51621584A01 516855R0004 517285R0003 5262155DA01 5263155A004 5268555A004 5268555DA01 5272555DA04 5272855DA01 |

| SM5401 | |
|--------|---|
| | Honda 5163152A004 51631TK5A01 5168952A004 516895H3004 517285R0003 51728TK5A01 5272850A004 |

| SM5402 | |
|--------|---|
| | Honda 5172655A701 5192055A751 5192055A761 5192555A751 5192555A761 |

| SM5403 | |
|--------|---|
| | Honda 5172655A004 5192055A014 5192055A024 5192056M014 5192056M01 5192056M02 5192057A024 5192555A024 5192556M014 5192556M02 5192557A014 5192557A024 |

| SM5405 | |
|--------|--|
| | Mazda BC1D28390A BC1D28390B |

| SM5406 | |
|--------|--|
| | Mazda BC1D28380A BC1D28380B |

| SM5409 | |
|--------|---|
| | Nissan 543203Z000 543204U000 543208H310 543208H320 543208J001 543208Z001 54320AU700 54320AU701 54320CA002 54320CG000 54320CL70A 54320CN100 543258J000 |

| SM5422 | |
|--------|---|
| | Subaru 20370FE100 20370FE101 20370FE110 20390FE000 20390FE010 32005858 32005859 |

| SM5423 | |
|--------|--|
| | Lexus, Toyota 4860906090 4860908020 486090E010 4860933150 4860933160 4860948010 4860948020 9090363002 9090363014 |

| SM5427 | |
|--------|---|
| | Mazda B25D34380 B25D34380A B25D3438X CB0134380 |

| SM5428 | |
|--------|--|
| | Mazda GJ6A34380B GJ6A34380C GJ6E34380B GK2A34380A GK2A34380B |

| SM5443 | |
|--------|---|
| | Mini 31306764884 31306769741 31306778833 31336759498 |

| SM5444 | |
|--------|---|
| | Mini 33506789027 33506789028 33509807871 33509807872 33526754123 33526754124 |

| SM5445 | |
|--------|---|
| | Mercedes Benz, Volkswagen 2D0407183 2D0407183A 9013230085 9013231185 |

| | |
|---------------|---|
| SM5446 | |
| | Audi 4D0412369A 4F0412377D 8E0412377 8E0412377C WHT001484 |

| | |
|---------------|---|
| SM5451 | |
| | Chevrolet - Daewoo 95015324 96535010 96535011 96653239 |

| | |
|---------------|---|
| SM5452 | |
| | Chevrolet - Daewoo 96456713 96456715 96535166 |

| | |
|---------------|--|
| SM5453 | |
| | Kia OK01134701A OK01134702 OK01134703A OK01134777A OK01134797 OK01134799A |

| | |
|---------------|--|
| SM5454 | |
| | Kia OK30A34390B OK30A34390C |

| | |
|---------------|--|
| SM5455 | |
| | Kia 546033E000 546043E100 546063E000 546073E000 546093E000 |

| | |
|---------------|---|
| SM5459 | |
| | Mazda GD7A34380 GD7A3438X GG2A34380 |

| | |
|---------------|---|
| SM5461 | |
| | Mitsubishi MR272946 MR491431 MR554860 MR589877 |

| | |
|---------------|---|
| SM5462 | |
| | Nissan 55323CA000 55323CA00A 56113CA000 56113CA00A 56217CA000 56218CA000 |

| | |
|---------------|---|
| SM5472 | |
| | Toyota 4860952020 4860952021 |

| | |
|---------------|-----------------------------|
| SM5474 | |
| | Toyota 4860947020 |

| | |
|---------------|-------------------------------------|
| SM5475 | |
| | Volvo 30714968 8634457 |

| | |
|---------------|--------------------------|
| SM5477 | |
| | Kia 54615FD000 |

| | |
|---------------|--------------------------|
| SM5478 | |
| | Kia 54610FD000 |

| | |
|---------------|--------------------------|
| SM5479 | |
| | Kia OK2NA34380 |

| | |
|---------------|---|
| SM5480 | |
| | Kia OK2NA28390 OK2NA28390A |

| | |
|---------------|---|
| SM5481 | |
| | Kia OK2NA28380 OK2NA28380A |

| | |
|---------------|---|
| SM5482 | |
| | Nissan 55323AR000 55323AR00A 561134U000 561134U00A 56217AM001 56218AG000 |

| | |
|--|---|
| <p>SM5487</p>  | <p>Suzuki 4171060G10 4174260G00</p> |
| <p>SM5490</p>  | <p>Lexus 4868022150 4868053010</p> |
| <p>SM5491</p>  | <p>Lexus 487500E010</p> |
| <p>SM5492</p>  | <p>Lexus 487600E010</p> |
| <p>SM5493</p>  | <p>Volvo 30666271 31262065 9157745</p> |
| <p>SM5494</p>  | <p>Ford 7234730 95AB5789AA</p> |
| <p>SM5498▼</p>  | <p>Opel, Vauxhall 344504 90135318</p> |
| <p>SM5499</p>  | <p>Mercedes Benz 6383230420 6389810120</p> |
| <p>SM5501</p>  | <p>Mercedes Benz 2113200026</p> |
| <p>SM5502▼</p>  | <p>Nissan 5432001P10 5432001P20 5432021P00 543250B000 5432521000 543257B000</p> |
| <p>SM5503</p>  | <p>Nissan 5432030R00 5432030R01 5432085E00 5432085E10 5432089E00 543209C000 543250B000 5432521000 543257B000</p> |
| <p>SM5504</p>  | <p>Volvo 30818465</p> |
| <p>SM5505</p>  | <p>Skoda 823412355</p> |
| <p>SM5508</p>  | <p>Volkswagen 133412365 171412329A 175412329</p> |
| <p>SM5539</p>  | <p>Hyundai, Kia 546102B000 546102B100 546104D000 546123J000 546124D000</p> |
| <p>SM5581</p>  | <p>Ford 1480525 157Z18198A 4986166 7T163K155AA 7T1Z3A197A</p> |
| <p>SM5586</p>  | <p>Land Rover RNR100080 RNX100101</p> |
| <p>SM5589</p>  | <p>Ford, Mazda, Volvo 1223835 1250820 1255350 1334230 1339553 1377471 1381605 1502144 1508111 1741612 1820233 1824950 2034127 →...</p> |

| SM5589 | | |
|-------------|--------------|--------------|
| →... | 8V413K155AB | C23634380A |
| 30639948 | B39D34380 | C23634380B |
| 30647733 | B39D34380A | C23634390A |
| 30666194 | BBM234380 | C23634390B |
| 30666530 | BBM23438X | C2733438XA |
| 30681546 | BBT934380 | C2733438XB |
| 31262470 | BP4K34380A | C51334380 |
| 3M513K099AA | BP4K34380B | C51334390 |
| 3M513K099AB | BP4K34380C | CV613K155B2A |
| 3M513K099AC | BP4K34380D | CV613K155BA |
| 3M513K099AD | BP4K3438XA | |
| 3M513K155DA | BP4K3438XB | |
| 3M513K155DB | BP4L34380 | |
| 3M513K155DC | BV613K155C2A | |
| 6M5Y3K155AA | BV613K155C2B | |

| SM5596 | |
|---|--------------------------------|
|  | Land Rover RPF100123 |

| SM5597 | |
|---|--|
|  | Lexus 9038712050 9094801062 9094801063 9094801082 9094801083 9094801089 9094801090 9094803021 9094803023 |

| SM5601 | |
|---|---|
|  | Dodge, Jeep 5085458AA 5085461AA 5085461AB |

| SM5610 | |
|---|---|
|  | Opel, Vauxhall 13500663 13500664 13503548 13503548 13503549 20859330 20967947 22744295 22802090 22865931 22894950 344468 344469 →... |

| SM5610 | |
|--------|--|
| →... | 344469 344628 344958 344958 92245258 |

| SM5615 | |
|--|--|
|  | Honda 51726SNA013 51726SNA013 51920SNA023 51920SVBA03 |

| SM5617 | |
|--|--|
|  | Hyundai 553303F600 553303K000 553303K010 553303K020 553303K610 553303K620 553303L010 553303L020 553313F600 553323K000 |

| SM5618 | |
|--|--|
|  | Hyundai 546303F600 546303K000 546303L000 546303L100 546413K000 546453K010 546453L000 |

| SM5620 | |
|---|--|
|  | Mazda F15128773 F15128774 F15128775A F15128775B F15128776 F15128776A NH4628776 |

| SM5626 | |
|---|---|
|  | Nissan 54320EL00A 54320ZE70A 54325AX000 54325ED00A 54325ED02A |

| SM5627 | |
|---|---|
|  | Nissan 54321EL000 54321ZE70A 54325AX000 54325ED00A 54325ED02A |

| SM5637 | |
|---|---|
|  | Toyota 4860906130 4860906190 4860906200 486090E010 4860933190 4860933210 4860948040 9008036070 9090363002 9090363014 |

| SM5639 | |
|---|---|
|  | Toyota 4860902240 4860912500 4860912550 4860912570 4860942030 4860942060 9017810030 |

| SM5641 | |
|---|---|
|  | Toyota 4830452050 4830452051 4860952100 486190D010 486190D011 4868252040 |

| SM5647 | |
|---|--|
|  | Volvo 30616824 30616825 30630388 30652259 30875399 30889584 |

| SM5651 | |
|---|---|
|  | Opel, Vauxhall 13242434 13245922 13271702 13271706 22834078 22834080 436427 436429 436437 436457 436785 436789 |

| SM5652 | |
|---|---|
|  | Opel, Vauxhall 13242433 13245921 13271701 13271705 22834077 22834079 424700 436426 436428 436435 436784 436788 |

| | |
|--|---|
| <p>SM5654</p>  | <p>Honda 51726SAA003 51726SAA013 51726SFA005 51920SCC015 51925SLN005 51925TK6A01</p> |
| <p>SM5655▼</p>  | <p>Honda 51726STKA01 51726SWAA00 51726SWAA01 51920STKA03 51920SWAA01</p> |
| <p>SM5656</p>  | <p>Hyundai, Kia 553111G000 553221C000</p> |
| <p>SM5657</p>  | <p>Citroën, Mitsubishi, Peugeot MN101372 MR272946</p> |
| <p>SM5658</p>  | <p>Toyota 486090R010 4860942020 486190R010 4861942010</p> |
| <p>SM5660</p>  | <p>Mini 31306772749</p> |
| <p>SM5661</p>  | <p>Hyundai 546102C000 546121G010 546122C000</p> |
| <p>SM5662</p>  | <p>Kia 546122C000 546201D000 546202G000</p> |
| <p>SM5663</p>  | <p>Kia 546101D000 546102G000 546122C000</p> |
| <p>SM5664</p>  | <p>Subaru 20320AG00A 20320FG000 20320FG001 20320FG010 20320FG011 20320XA00A 20320XA00A9E</p> |
| <p>SM5665</p>  | <p>Toyota 4860921070 4860947030 4860947031 4860947040 4860972010 4860975020 4861928010</p> |
| <p>SM5666</p>  | <p>Audi 8K0513353E 8K0513353F</p> |
| <p>SM5667</p>  | <p>BMW 33526753810 33526769744 33526779611 33536753765</p> |
| <p>SM5668</p>  | <p>Hyundai, Kia 546102H000 546102H200 546102H300 546122C000</p> |
| <p>SM5669</p>  | <p>Hyundai, Kia 553302H000 553302L000</p> |
| <p>SM5670</p>  | <p>Hyundai, Kia 546101G500 546101G505 546101G550 546101G555 546122C000</p> |
| <p>SM5671</p>  | <p>Ford 1371348 1377929 1377973 1488960 1815863 6C1118183AB 6C1118183AC 6C113K099AA 6C113K099AB BK213K099AC</p> |
| <p>SM5674</p>  | <p>Smart 4503300051 A4503220028 A4513200029 A4513200129 A4513200229 A4513220028 Q0006697V004000000 Q0008236V003000000 Q0008236V004000000</p> |

| | | | | | |
|--|--|--|--|--|--|
| <p>SM5675▼</p>  | <p>Peugeot 50380000</p> | <p>SM5676</p>  | <p>Volvo 30681642 30736503 30794009 30794012 31200897 31200936 31201027 31277096 31277826 31317210 31317464 31340241 31340242 31340605 31340606</p> | <p>SM5692</p>  | <p>Mazda EG2134380B L2083438X TD1134380 TD1134380A TD1134380B</p> |
| <p>SM5698</p>  | <p>Nissan 4171182Z00 56115EA001</p> | <p>SM5720</p>  | <p>Suzuki 4174165J00 4174178K00 4181065J00</p> | <p>SM5721</p>  | <p>Chevrolet - Daewoo 4171085Z00 4172685Z00 4174285Z00 94535236 96435521 96549920 96549921</p> |
| <p>SM5729▼</p>  | <p>Chevrolet - Daewoo 13501409 13505131</p> | <p>SM5731</p>  | <p>Kia 546112K000 546112K100 5461207000 546272K000</p> | <p>SM5736</p>  | <p>Fiat, Suzuki 4171079J00 4171079J01 4171080J00 4172080J00 4172080J01 4174260G00 71742680 71747291</p> |
| <p>SM5740</p>  | <p>Suzuki 4171054G10 4174260G00</p> | <p>SM5752</p>  | <p>BMW 33506767010 33506771737 33506771738 33526764418</p> | <p>SM5776</p>  | <p>Kia 546102P000 546122M000 546122P000</p> |
| <p>SM5784</p>  | <p>Audi 8K0412377A 8K0412377B 8K0412377C 8K0412377D WHT001484</p> | <p>SM5785</p>  | <p>Mercedes Benz A1693200073</p> | <p>SM5786</p>  | <p>Subaru 20370AJ00A 20370FG000 20370FG001 20370FG002 20370FG010 20370FG011 20370FG012</p> |
| <p>SM5787</p>  | <p>Land Rover LR001145 LR018785 LR024477 LR032578</p> | <p>SM5788</p>  | <p>Jeep 5085495AA 5085495AB 5085495AC 5085505AD</p> | <p>SM5789</p>  | <p>Honda 51675TA0A01 51675TA0A02 51686TA0A01</p> |

| | |
|--|---|
| <p>SM5790</p>  | <p>Honda 51676TA0A01 51676TA0A02 51686TA0A01</p> |
| <p>SM5791▼</p>  | <p>Kia 546102P000 546122M000 546122P000</p> |
| <p>SM5792</p>  | <p>Hyundai, Kia 546102T000 546123S050</p> |
| <p>SM5793</p>  | <p>Peugeot 503562 5038H9</p> |
| <p>SM5794</p>  | <p>Peugeot 503562 5038J0</p> |
| <p>SM5795▼</p>  | <p>Chevrolet - Daewoo 96422462 96440030</p> |
| <p>SM5796</p>  | <p>Suzuki 4171057L00 4174178K00</p> |
| <p>SM5797</p>  | <p>Subaru 20320AG000 20320AG01A</p> |
| <p>SM5798</p>  | <p>Subaru 20370XA00C</p> |
| <p>SM5799</p>  | <p>Toyota 4875017050 9008038148</p> |
| <p>SM5802</p>  | <p>Ford, Mazda 1535299 8V5118A116AA DF712870XC DR612870X DR612870XD</p> |
| <p>SM5803</p>  | <p>Nissan 54320JP00A 54325JA000 54325JA00A</p> |
| <p>SM5810</p>  | <p>BMW 31336778101 33524057982 33524057984 33526771527 33526776399 33526776557 33526778111 33526782867 33526782868 33526862139</p> |
| <p>SM5813</p>  | <p>Jeep 5168088AA 68194317AA 68194317AB 68194317AC 68245325AA 68245325AB 68245325AC</p> |
| <p>SM5814</p>  | <p>Jeep 5168088AA 68194316AA 68194316AB 68194316AC 68245324AA 68245324AB 68245324AC</p> |
| <p>SM5818</p>  | <p>Hyundai, Kia 546111J000 546111P000 546111W000 546111Y000 5461207000 546120U000 5462707000 546271R600</p> |
| <p>SM5819</p>  | <p>Kia 546111J000 546111P000 546111W000 546111Y000 5461207000 546272K000 549120U000</p> |
| <p>SM5835</p>  | <p>BMW 33526764264 33526764266 33526764267 33526768837 33526768838 33526769295</p> |

| SM5836 | |
|--------|---|
| | Nissan 553231HD0A 561131HD0A 562171HA0B |

| SM5837 | |
|--------|---|
| | Nissan 55323AX000 56113AX000 56217AX000 |

| SM5838 | |
|--------|---|
| | Nissan 543203JA0A 54320JN00B 543253TA0A 54325JA000 54325JA00A 544593JA0A 544593JA0B 54459JP02B |

| SM5839 | |
|--------|---|
| | Nissan 543201HA0B 543201HJ0A 543203VA0A 543251HA0A 543251HA0B 543421HA0B 543421HA0C 543421HJ0B |

| SM5843 | |
|--------|---|
| | Chevrolet - Daewoo 95194748 95218007 95975658 96682599 |

| SM5850 | |
|--------|---|
| | Hyundai, Kia 553302S000 553302S050 553302S100 553302S150 553302S200 553303R010 553303R011 553303V011 553303W100 553304W500 |

| SM5887 | |
|--------|-----------------------------------|
| | Opel, Vauxhall 13485955 |

| SM5888 | |
|--------|---|
| | Opel, Vauxhall 39028988 39185990 |

| SM5890 | |
|--------|--|
| | Mazda TK5228380B TK5228380C |

| SM5891 | |
|--------|---|
| | Fiat, Jeep 51936582 68246697AA 68299201AC |

| SM5892 | |
|--------|---|
| | Fiat, Jeep 51936583 68246697AA 68246730AA |

| SM6000 | |
|---|-------------------------------|
|  | Alfa Romeo 46791956 |

| SM8101 | |
|---|---|
|  | Subaru 20370AC210 20370AC211 20370AC251 |

| SM8102 | |
|---|---|
|  | Subaru 20370AC200 20370AC201 20370AC241 |

| SM9000 | |
|---|---|
|  | BMW 33504035929 33521092362 33521125554 33521128819 33521137972 |



















| SM9002 | |
|---|---------------------------|
|  | BMW 33521093416 |

| SM9004 | |
|---|--|
|  | BMW 33521091238 33521094091 |

| SM9005 | |
|---|---------------------------|
|  | BMW 33521132270 |

| | | | | | |
|---|---|--|--|--|--|
| <p>SM9006</p>  | <p>BMW 33521132088</p> | <p>SM9008▼</p>  | <p>BMW 33506771737 33506771738</p> | <p>SM9010</p>  | <p>Chevrolet - Daewoo 94515455 96457360</p> |
| <p>SM9200</p>  | <p>Ford, Mazda 1023587 1101042 1E0028012A 96FB18198A2G 96FB18198AG</p> | <p>SM9201</p>  | <p>Ford 6807407 6838725 93BB18198BA 93BB18198BC</p> | <p>SM9202</p>  | <p>Ford, Mazda 1330706 256118A116AD</p> |
| <p>SM9203▼</p>  | <p>Ford, Mazda 1233950 1300459 1444281 1692273 1725158 1745064 3M5118A116AA 3M5118A116AB 3N6118A116AA AV6118A116AC AV6118A116AD AV6118A116AE</p> | <p>SM9204</p>  | <p>Ford 1116780 1205834 1205835 1303625 157118198AD 157118198AF 157118198AG 157118198AH</p> | <p>SM9500</p>  | <p>Renault 7700846916</p> |
| <p>SM9501</p>  | <p>Renault 7700805922</p> | <p>SM9700</p>  | <p>Seat, Skoda, Volkswagen 191512333 191512335</p> | <p>SM9701</p>  | <p>Audi 443512331</p> |
| <p>SM9703</p>  | <p>Audi, Seat, Skoda, Volkswagen 1J0513353D</p> | <p>SM9704</p>  | <p>Audi, Seat, Skoda, Volkswagen 1J0513353A 1J0513353B 1J0513353C 1J0513353G 6QE513353 6R0513353 6R0513353B</p> | <p>SM9705</p>  | <p>Audi 8A0512333 8A0512335</p> |
| <p>SM9706</p>  | <p>Audi, Volkswagen 8E0513353B</p> | <p>SM9707</p>  | <p>Audi, Seat, Volkswagen 1K0513353G</p> | <p>SM9708</p>  | <p>Audi, Volkswagen 1K0513353H 1K0513353J</p> |

| | | | | | |
|--|--|--|---|---|--|
| <p>SM9709</p>  | <p>Audi, Seat, Skoda, Volkswagen 3C0513353 3C0513353C 3C0513353D</p> | <p>SM9711</p>  | <p>Volkswagen 1Q0513353</p> | <p>SM9801▼</p>  | <p>Fiat 5960254 7567589</p> |
| <p>SM9803</p>  | <p>Alfa Romeo, Fiat, Lancia 60507954 82430666</p> | <p>SM9805</p>  | <p>Alfa Romeo, Fiat, Opel, Vauxhall 11900441 2066249 436774 51803172 51885482 55701901 55703318</p> | <p>SM9806</p>  | <p>Alfa Romeo, Fiat, Opel, Vauxhall 436773 51803173 51885481 55701902 55703317</p> |
| <p>SM9807</p>  | <p>Fiat, Lancia 51901342</p> | <p>SM9808</p>  | <p>Nissan 55320BM400</p> | <p>SM9900</p>  | <p>Peugeot 516120</p> |
| <p>SM9901</p>  | <p>Citroën, Peugeot 514232</p> | <p>SM9902</p>  | <p>Citroën, DS, Peugeot 514234</p> | <p>SM9903▼</p>  | <p>Citroën, Peugeot 514248</p> |
| <p>SM9904</p>  | <p>Peugeot 514245</p> | <p>SM9905</p>  | <p>Toyota 487550D010 487550D070 4875552070</p> | <p>SM9907</p>  | <p>Mercedes Benz A2043200373 A2043200873 A2043200973 A2043201073 A2043260664 A2043260764 A2123260464 A2123260564 A2183260064 A2183260464</p> |
| <p>SM9908</p>  | <p>Opel, Vauxhall 13345953 13345955 436662 436663</p> | <p>SM9909</p>  | <p>Ford 1437051 31317461 31429386 6G9118A116AAA</p> | <p>SM9910</p>  | <p>Volvo 30714349 30760162</p> |

| | | | | | |
|---|---|--|---|--|---|
| <p>SM9911</p>  | <p>Toyota 4875502080 4875502090 4875512100 9094802159</p> | <p>SM9912</p>  | <p>Peugeot 514249</p> | <p>SM9913</p>  | <p>Citroën, Peugeot, Toyota 521035 522075 6822K1</p> |
| <p>SM9914</p>  | <p>Renault 562107519R 7700426693 8200287736 8200662259</p> | <p>SM9915</p>  | <p>Nissan 553231KA0A 55323BA60A 561131KA0A 56113BA60A 562171KA0A</p> | <p>SM9916</p>  | <p>Dacia, Renault 6020034 6020103 562100385R 562105043R 562106313R 6001547072 8200417472 8200633372 8200742812 8200807035 8200953294</p> |
| <p>SM9917</p>  | <p>Toyota 4875005040 4875505010 9094803021</p> | <p>SM9918</p>  | <p>Audi, Seat 4F0513353D</p> | <p>SM9919</p>  | <p>Nissan 543208H310 543208H320 54320CG000 54320CN100</p> |
| <p>SM9920</p>  | <p>BMW 7119905374 33503401685 33503413925 33503450542 33526762325 33526776759</p> | <p>SM9921</p>  | <p>Toyota 487520H010 4875502090 9094802159</p> | <p>SM9923</p>  | <p>Mitsubishi, Smart A0019903382 A4543260050 A4543260053 A4543260150 MR594125 MR594126 MR594135 MR594136</p> |
| <p>SM9924</p>  | <p>Audi, Seat, Volkswagen 5Q0513353H N90648402</p> | <p>SM9925</p>  | <p>Audi, Seat, Skoda, Volkswagen 5Q0513353G 5Q0513353J N90648402</p> | <p>SM9926</p>  | <p>BMW, Mini 7119907137 33504087804 33506791706 33506798876 33506862725 33506864452 33506865257 33506865260</p> |
| <p>SM9927</p>  | <p>BMW 33506781682 33506781683 33506781988 33506863303 33506863340 61357684057</p> | <p>SM9928</p>  | <p>Seat, Skoda, Volkswagen 150512335A 321512117A 6X0512337A</p> | <p>SM9929</p>  | <p>BMW 7119905374 33506775735 33506776140 33506776141 33506772211 33506859919 33506863299 33506863301</p> |

| SM9930 | |
|--------|---|
| | Opel, Suzuki, Vauxhall 4180051KA0 4180057K01 4180057KA1 4180062J01 4180063J02 4180063J52 4180068L01 4180070L00 4181070L01 4181071L21 4181071L71 4181257K00 →... |

| SM9930 | |
|--------|---|
| | →... 4181263J00 4181357K00 4181363J00 4708275 93193098 |

| SM9938 | |
|--------|---|
| | Toyota 487550F010 487550F020 9094802159 |

| SM9939 | |
|--------|--|
| | Seat, Volkswagen 191512119 321512117A 357512147 6X0512335 6X0512337A |

| SM9942 | |
|--------|--|
| | Ford 1087337 98AG18A116AE |

| SM9943 | |
|--------|---|
| | Hyundai, Kia 5531507000 553151C000 553221C000 5532307000 553231C000 553231C001 5532407000 553241C000 |





| Alternative PN | | | | Discontinued PN | | | | | | |
|----------------|---|-----------------|------------|-----------------|----------------|--------|---------|--------|--------|--------|
| KYB | → | Alternative PN | KYB | → | Alternative PN | | | | | |
| 332504 | → | 3320035 | 910036 | → | 910353 | 243025 | 334331 | 441103 | 554063 | 634094 |
| 332505 | → | 3320036 | 910038 | → | 910354 | 322032 | 334332 | 441801 | 554072 | 634102 |
| 333504 | → | 3330056 | 910111 | → | 910270 | 322033 | 334500 | 442029 | 554080 | 634103 |
| 333505 | → | 3330057 | 910138 | → | 910081 | 324008 | 334501 | 442035 | 554083 | 663029 |
| 333516 | → | 3330052 | 910147 | → | 910022 | 324009 | 334600 | 443008 | 554084 | 665049 |
| 333517 | → | 3330053 | 912003 | → | 910082 | 324028 | 334601 | 443019 | 554098 | 665050 |
| 333932 | → | 333909 | 912022 | → | 913237 | 324029 | 335001 | 443038 | 554099 | 733049 |
| 333933 | → | 333910 | 912027 | → | 912052 | 331037 | 335624 | 443071 | 554146 | 733050 |
| 334504 | → | 339746 | 913113 | → | 910085 | 331038 | 335625 | 443087 | 554200 | 734023 |
| 334505 | → | 339747 | 913128 | → | 910085 | 332002 | 335906 | 443099 | 554339 | 734024 |
| 334508 | → | 3340083 | 915205 | → | 910081 | 332003 | 335907 | 443108 | 555003 | 734044 |
| 334509 | → | 3340084 | 915209 | → | 910090 | 332019 | 335917 | 443253 | 555004 | 734045 |
| 334632 | → | 3348049 | 915322 | → | 910083 | 332020 | 341069 | 443261 | 632008 | 734050 |
| 334633 | → | 3348050 | 915408 | → | 910087 | 332025 | 341106 | 443288 | 632009 | 734051 |
| 334967 | → | 339808 | 915702 | → | 910089 | 332060 | 341109 | 443400 | 632032 | 910012 |
| 334968 | → | 339809 | 915703 | → | 910089 | 332084 | 341170 | 444095 | 632033 | 910030 |
| 334970 | → | 339718 | 915803 | → | 910086 | 332085 | 341215 | 444097 | 632087 | 910120 |
| 334971 | → | 339719 | 915809 | → | 913268 | 333020 | 341800 | 444098 | 632088 | 912004 |
| 334972 | → | 339818 | 916024 | → | 910085 | 333022 | 341801 | 444101 | 632101 | 913242 |
| 334973 | → | 339819 | 917002 | → | 910082 | 333023 | 341802 | 444140 | 632102 | 915407 |
| 335607 | → | 335839 / 335840 | 930003 | → | 910164 | 333030 | 341962 | 445008 | 632110 | 915700 |
| 335612 | → | 339735 | 935304 | → | 912053 | 333031 | 343009 | 445009 | 632111 | 915808 |
| 335613 | → | 339736 | SM1213 | → | SM1811 | 333063 | 343011 | 551005 | 632118 | 930004 |
| 335923 | → | 339759 | SM1507 | → | SM1018 | 333064 | 343071 | 551032 | 632119 | 945902 |
| 341705 | → | 341900 | SM1701 | → | SM1700 | 333075 | 343081 | 551052 | 633010 | SM1013 |
| 341716 | → | 3440028 | SM1711 | → | SM5236 | 333153 | 343084 | 551059 | 633011 | SM1214 |
| 343601 | → | 349007 | SM1712 | → | SM5236 | 333154 | 343154 | 551060 | 633021 | SM1312 |
| 3440008 | → | 3440035 | SM1812 | → | SM1810 | 333223 | 343189 | 552017 | 633041 | SM1510 |
| 345622 | → | 341720 | SM5206 | → | SM9942 | 333324 | 343199 | 553017 | 633046 | SM1518 |
| 348008 | → | 343418 | SM5729 | → | SM1008 | 333325 | 343293 | 553018 | 633047 | SM1520 |
| 441803 | → | 441900 | SM5791 | → | SM5776 | 333500 | 343294 | 553022 | 633055 | SM1532 |
| 633834 | → | 633802 | SM9008 | → | SM5752 | 333501 | 344031 | 553056 | 633056 | SM1555 |
| 910028 | → | 910348 | SM9903 | → | SM9901 | 333507 | 344031 | 553103 | 633060 | SM1808 |
| 910032 | → | 910350 | | | | 333741 | 344501 | 553103 | 633060 | SM1808 |
| 910034 | → | 910351 | | | | 333741 | 344501 | 553103 | 633060 | SM1808 |
| 910035 | → | 910352 | | | | 333813 | 344663 | 553111 | 633061 | SM1809 |
| | | | | | | 333834 | 3448007 | 553112 | 633072 | SM1908 |
| | | | | | | 334006 | 345086 | 553114 | 633073 | SM1928 |
| | | | | | | 334007 | 349035 | 553120 | 633082 | SM2001 |
| | | | | | | 334034 | 349133 | 553124 | 633090 | SM5045 |
| | | | | | | 334035 | 363002 | 553142 | 633091 | SM5065 |
| | | | | | | 334036 | 363016 | 553146 | 633107 | SM5099 |
| | | | | | | 334037 | 363023 | 553169 | 633108 | SM5100 |
| | | | | | | 334038 | 363043 | 553170 | 633119 | SM5136 |
| | | | | | | 334039 | 364022 | 553194 | 633120 | SM5172 |
| | | | | | | 334040 | 365007 | 553195 | 633219 | SM5242 |
| | | | | | | 334059 | 365018 | 553196 | 633220 | SM5274 |
| | | | | | | 334060 | 365037 | 553212 | 633712 | SM5288 |
| | | | | | | 334086 | 365047 | 553227 | 633812 | SM5298 |
| | | | | | | 334087 | 365054 | 553287 | 633817 | SM5299 |
| | | | | | | 334121 | 365065 | 554021 | 634012 | SM5304 |
| | | | | | | 334122 | 441052 | 554035 | 634013 | SM5368 |
| | | | | | | 334211 | 441060 | 554036 | 634016 | SM5370 |
| | | | | | | 334212 | 441072 | 554039 | 634017 | SM5374 |
| | | | | | | 334215 | 441085 | 554041 | 634029 | SM5495 |
| | | | | | | 334216 | 441086 | 554052 | 634035 | SM5500 |
| | | | | | | 334325 | 441099 | 554054 | 634093 | SM9922 |

